

sistemas de almacenaje y mobiliario para vestuario y colectividades
storage systems and furniture for locker rooms and community buildings • systèmes de stockage et équipements pour vestiaires et collectivités

e s t a n t e r í a s
JOMASI

CATÁLOGO GENERAL

Grupo **M**adriferr
Suministros Industriales

Confíe en nosotros, tenemos

Trust in us, we have the made-to-measure solutions you require
 Faîtes-nous confiance, nous avons la solution sur mesure

soluciones a su medida

6-21

Ángulo ranurado
 Slotted angle shelving
 Angle cranté



Kits juegos completos
 Complete kits
 Jeux complets

22-27

Idea 5 sistema de encastre
 Idea 5 socket system
 Idea 5 système d'encastrement



Kits juegos completos
 Complete kits
 Jeux complets

50-67

Mobiliario para vestuario y colectividades
 Furniture for locker rooms and community buildings
 Equipement pour vestiaires et collectivités



82-87

Paletización convencional
 Conventional palletization
 Palettisation conventionnelle



88-91

Cantil Sigma
 Cantil Sigma
 Cantil Sigma



92-95

Entreplanta modular
 Modular mezzanine floor
 Plate-forme modulaire



nuevo / new / nouveau



28-33

Cromo / Chrome / Chromé

Kits juegos completos
 Complete kits / Jeux complets



34-49

Línea blanca
 White line
 Ligne blanche



68-81

J600 sistema de encastre
 J600 socket system
 J600 système d'encastrement

Kits juegos completos
 Complete kits / Jeux complets

Bancos
 Work benches / Bancs de travail

Las mejores soluciones de almacenamiento para sus productos

The best solutions for storing your products • Les meilleures solutions de stockage pour vos produits

CONDICIONES GENERALES

- Los **pedidos** se efectuarán mediante vía fax, e-mail o correo ordinario. No se suministrarán pedidos inferiores a 100 euros netos, siendo retenidos hasta que la acumulación de nuevos pedidos supere el importe mínimo.
- Cuando la mercancía viaje a **portes pagados** por Estanterías Jomasi S.L., se reserva el derecho de contratar dicho servicio con la agencia de transporte que considere más oportuno. El transporte se considera hasta la puerta del cliente, y en ningún caso la descarga cuando se envíe por camión de ruta, ni la ubicación en el interior de las instalaciones del cliente cuando sea agencia de reparto de plaza.
- La **reexpedición** a un domicilio distinto al del cliente conlleva un costo de 12 euros por trámites de administración.
- La visible recepción de **material defectuoso o erróneo**, deberá hacerse constar en el albarán del transporte y, posteriormente, en un plazo máximo de 24 horas y por escrito a Estanterías Jomasi S.L. De lo contrario se entenderá la aceptación de la mercancía correcta y en buen estado.
- Los **plazos de entrega** indicados se entenderán orientativos. Estanterías Jomasi S.L. no será responsable de ningún retraso de los materiales originado como consecuencia de causas ajenas a su voluntad, no constituyendo motivo de anulación por parte del comprador ni penalización por perjuicios que puedan derivar terceros al cliente.
- La **devolución de mercancía** por motivos propios del cliente, y no habiendo transcurrido 30 días desde la compra de dicha mercancía, Estanterías Jomasi S.L. se reserva el derecho a abonar la mercancía aplicando una desvalorización del 10%, además del costo que haya originado el transporte.
- Estanterías Jomasi S.L. se reserva **la plena propiedad de las mercancías** hasta que el cliente haya satisfecho, totalmente, el pago pactado.
- La **devolución de un pago** supone un incremento del 4% en el importe de la factura.
- Es norma de Estanterías Jomasi S.L. **no servir ningún pedido** si existe alguno anterior pendiente de pago.
- En caso de **controversia o litigio** ambas partes aceptan, con renuncia expresa al fuero propio del cliente, la competencia de los Tribunales de Zaragoza.



La apertura de un paquete se considera "empaquetado especial" con un coste de 1,85 €/neto
Opening of packages is treated as "special packaging" and has a cost of 1.85 €/net
L'ouverture d'un paquet est considérée "emballage spécial" et a un coût de 1,85 €/net

LEYENDA DE SÍMBOLOS

Symbol legend • Légende de symboles

L longitud / length / longueur
P profundidad / depth / profondeur
H altura / height / hauteur
A ancho / width / largeur
1R: un refuerzo / one reinforcement / un renfort
2R: dos refuerzos / two reinforcements / deux renforts

medidas mm / measurements mm / mesures mm
volumen m³ / volume m³ / volume m³
peso k / weight k / poids k

Móntelo Vd. mismo / Do-it-yourself assembly / Montez-le vous-même
Montaje por profesionales / Assembly by professionals / Montage par professionnels



GENERAL TERMS

- Orders** are to be placed by fax, e-mail or ordinary mail. We cannot supply orders that amount to less than 100 net euros. Orders will be retained until the amount of accumulated new orders is more than this minimum amount.
- If goods are sent **carriage paid**, Estanterías Jomasi S.L. reserves the right to contract said service with the transport agency of its choice. Transport terms are to the customer's door and in no case does transport include unloading if sent by truck, nor placing it inside the customer's facilities if sent by a local delivery agency.
- Re-forwarding** to an address other than that of the customer will involve a cost of 12 euros by way of administration costs.
- Receipt of visibly **faulty or erroneous material** must be recorded on the transport delivery note and then reported, within a maximum period of 24 hours, in writing to Estanterías Jomasi S.L. otherwise material will be understood to have been received and accepted correctly and in a good state.
- Delivery times** are provided as a guideline. Estanterías Jomasi S.L. does not accept any liability for delays in materials that are a consequence of causes beyond its control nor will this be considered due reason for cancellation by the buyer, nor for any penalty by way of damages that third parties may attribute to the customer.
- If **goods are returned** by the customer, for the his/her own reasons, and no later than 30 days from the purchase of said material, Estanterías Jomasi S.L. reserves the right to credit the goods, applying a 10% devaluation as well as the cost of transport.
- Estanterías Jomasi S.L. reserves its **full ownership of the goods** until the customer has totally paid the agreed amount.
- The **return of a payment instrument** will add a cost of 4% to the invoice amount.
- It is Estanterías Jomasi S.L. policy **not to deliver an order** if there is a previous order that is pending payment.
- In the event of **discrepancies or litigation** both parties accept, with express waiver of any jurisdiction to which they may be entitled, to submit themselves to the competence of the Courts of Zaragoza.

CONDITIONS GENERALES

- Les **commandes** seront effectuées via fax, e-mail ou courrier ordinaire. Les commandes inférieures à 100 euros nets ne seront pas livrées et seront retenues jusqu'à ce que le cumul de nouvelles commandes dépasse le montant minimum.
- Quand la marchandise est transportée à **ports payés** par Estanterías Jomasi, S.L., celle-ci se réserve le droit de choisir l'agence de transport qu'elle considérera la plus opportune. Le transport est entendu jusqu'à la porte du client et n'inclura en aucun cas, le déchargement quand la commande est envoyée par camion routier ni l'emplacement à l'intérieur des locaux du client lorsqu'il s'agira d'agence de distribution sur place.
- La **réexpédition** à un domicile autre que celui du client entraîne un coût de 12 euros de gestion administrative.
- La réception visible de **matériel défectueux ou erroné** devra figurée sur le bon de transport puis communiquée, dans un délai maximum de 24 heures et par écrit à Estanterías Jomasi, S. L., sans quoi, il sera entendu que la marchandise acceptée est correcte et en bon état.
- Les **délais de livraison** sont donnés à titre indicatif, Estanterías Jomasi ne sera responsable d'aucun retard des matériels ayant pour origine des causes indépendantes de sa volonté et ne constituera pas de motif d'annulation de la part de l'acheteur ni de pénalisation pour préjudices au client pouvant dériver de tiers.
- En ce qui concerne le **retour de marchandise** pour des raisons propres du client et dans un délai inférieur à 30 jours depuis la date d'achat de cette marchandise, Estanterías Jomasi, S.L., se réserve le droit de rembourser cette marchandise en appliquant une dépréciation de 10%, outre le coût dérivé du transport.
- Estanterías Jomasi, S.L. se réserve **la pleine propriété des marchandises** jusqu'à ce que le client ait satisfait totalement le prix accordé.
- Le **retour d'un paiement** implique une majoration de 4% du montant de la facture.
- Estanterías Jomasi S.L., a pour norme de **ne servir aucune commande**, s'il en existe d'autres précédentes qui n'ont pas encore été réglées.
- En cas de **controverse ou litige**, les deux parties acceptent, le client renonçant expressément à sa propre juridiction, la compétence des Tribunaux de Saragosse.

ángulo ranurado

slotted angle shelving / angle cranté



- 1 Perfil / Upright / Profilé
- 2 Balda / Shelf / Tablette
- 3 Base de plástico / Plastic foot / Base en plastique
- 4 Escuadra / Corner piece / Équerre
- 5 Contenedor delantero / Front band / Conteneur avant
- 6 Contenedor trasero / Back band / Conteneur arrière
- 7 Divisor de contenedor / Band divider / Séparateur de conteneur
- 8 Tornillo / Bolt / Boulon
- 9 Divisor de pestaña / Wall divider / Séparateur ongllet
- 10 Cajón / Bin / Tiroir
- 11 Chapa lateral / Side plate / Tôle latérale
- 12 Chapa frontal / Front plate / Tôle avant

Un sistema muy versátil, económico y sencillo de montar. Idóneo para el almacenaje de cargas ligeras.

A highly versatile, cost-effective, easy-to-mount system. Ideal for the storage of light loads.

Un système très versatile, économique et simple à monter. Idéal pour le stockage de charges légères.

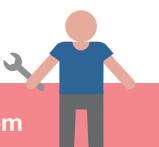

ángulo ranurado

slotted angle shelving / angle cranté

perfiles / uprights / profilés

gris / grey / gris

blanco / white / blanc

galvanizado / galvanized / galvanisée

inoxidable / stainless / inoxydable

Artículo L Item L Article L	Peso k Weight k Poids k	Uds. Paquete Units Package Unités Paquet	Referencia Reference Référence	€/Unidad €/Unit €/Unité	Cod. EAN EAN Code Code EAN	Referencia Reference Référence	€/Unidad €/Unit €/Unité	Cod. EAN EAN Code Code EAN	Referencia Reference Référence	€/Unidad €/Unit €/Unité	Cod. EAN EAN Code Code EAN	Referencia Reference Référence	€/Unidad €/Unit €/Unité	Cod. EAN EAN Code Code EAN
SE/35 de 2000	1,409	10	99013520		8431206135203	99023520		8431206235200	99093520		8431206935209			
SE/35 de 2500	1,762	10	99013525		8431206135258	99023525		8431206235255	99093525		8431206935254			
SE/35 de 3000	2,114	10	99013530		8431206135302	99023530		8431206235309	99093530		8431206935308			
SE/35 de 4000	2,818	10	99013540		8431206135401									
SE/40 de 2000	1,762	10	99014020		8431206140207	99024020		8431206240204	99094020		8431206940203	99004020		8431206040200
SE/40 de 2500	2,203	10	99014025		8431206140252	99024025		8431206240259	99094025		8431206940258	99004025		8431206040255
SE/40 de 3000	2,644	10	99014030		8431206140306	99024030		8431206240303	99094030		8431206940302	99004030		8431206040309
SE/40 de 4000	3,525	10	99014040		8431206140405									
SE/60 de 2000	2,428	10	99016020		8431206160205									
SE/60 de 2500	3,035	10	99016025		8431206160250									
SE/60 de 3000	3,642	10	99016030		8431206160304									

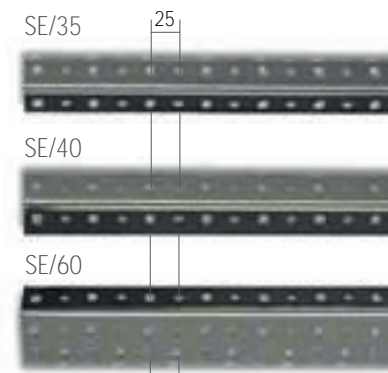

Corte a medida perfil: 0,30 €/neto / Upright cut-to size: 0.30 €/net / Coupe sur mesure profilé: 0,30 €/net

base sencilla / single foot / base simple

Artículo Item Article	Peso k Weight k Poids k	Unidades Envase Units Pack Unités Emballage	Referencia Reference Référence	€/Envase €/Pack €/Emballage	Cod. EAN EAN Code Code EAN
Base sencilla 35 Gris / Single foot Grey / Base simple Gris	0,041	Blister 4 / Blister pack / Blister	99010011		8431206100119
Base sencilla 35 Blanca / Single foot White / Base simple Blanc	0,041	Blister 4 / Blister pack / Blister	99010012		8431206100126
Base sencilla 40 Gris / Single foot Grey / Base simple Gris	0,042	Blister 4 / Blister pack / Blister	99010013		8431206100133
Base sencilla 40 Blanca / Single foot White / Base simple Blanc	0,042	Blister 4 / Blister pack / Blister	99010014		8431206100140
Base sencilla 35 Gris / Single foot Grey / Base simple Gris	0,650	Caja 100 / Box / Boîte	99010015		8431206100157
Base sencilla 35 Blanca / Single foot White / Base simple Blanc	0,650	Caja 100 / Box / Boîte	99010016		8431206100164
Base sencilla 40 Gris / Single foot Grey / Base simple Gris	0,672	Caja 100 / Box / Boîte	99010017		8431206100171
Base sencilla 40 Blanca / Single foot White / Base simple Blanc	0,672	Caja 100 / Box / Boîte	99010018		8431206100188
Base sencilla 35 Gris / Single foot Grey / Base simple Gris	9,750	Saco 1500 / Bag / Sac	99010019		---
Base sencilla 35 Blanca / Single foot White / Base simple Blanc	9,750	Saco 1500 / Bag / Sac	99010020		---
Base sencilla 40 Gris / Single foot Grey / Base simple Gris	10,080	Saco 1500 / Bag / Sac	99010021		---
Base sencilla 40 Blanca / Single foot White / Base simple Blanc	10,080	Saco 1500 / Bag / Sac	99010022		---
Base sencilla 60 Gris / Single foot Grey / Base simple Gris	---	1	99010025		---

base doble / double foot / base double

Artículo Item Article	Peso k Weight k Poids k	Unidades Envase Units Pack Unités Emballage	Referencia Reference Référence	€/Envase €/Pack €/Emballage	Cod. EAN EAN Code Code EAN
Base doble 35 Gris / Double foot Grey / Base double Gris	0,548	Caja 48 / Box / Boît	99010023		8431206100232
Base doble 40 Gris / Double foot Grey / Base double Gris	0,620	Caja 48 / Box / Boît	99010024		8431206100249
Base doble 60 Gris / Double foot Grey / Base double Gris	---	1	99010026		---



Pie metálico / Metal foot / Pied métallique Pletina / Levelling plate / Plaquette de calage
Consultar página 69 / Consult page 69 / Consulter page 69

ángulo ranurado

slotted angle shelving / angle cranté

sistemas de almacenaje y mobiliario para vestuario y colectividades storage systems and furniture for locker rooms and community buildings • systèmes de stockage et équipements pour vestiaires et collectivités **JOMASI** estanterías

baldas / shelves / tablettes

gris / grey / gris

blanco / white / blanc

galvanizado / galvanized / galvanisée

inoxidable / stainless / inoxydable

Artículo LxP Item LxD Article LxP	Peso k Weight k Poids k	Uds. Paquete Units Package Unités Paquet	Referencia Reference Référence	€/Unidad €/Unit €/Unité	Cod. EAN EAN Code Code EAN	Referencia Reference Référence	€/Unidad €/Unit €/Unité	Cod. EAN EAN Code Code EAN	Referencia Reference Référence	€/Unidad €/Unit €/Unité	Cod. EAN EAN Code Code EAN	Referencia Reference Référence	€/Unidad €/Unit €/Unité	Cod. EAN EAN Code Code EAN
500 x 300	1,233	6	99010503		8431206105039									
500 x 400	1,538	6	99010504		8431206105046									
600 x 200	1,094	6	99010602		8431206106029									
600 x 300	1,454	6	99010603		8431206106036	99020603		8431206206033	99090603		8431206906032	99000603	Consultar	8431206006039
600 x 400	1,813	6	99010604		8431206106043	99020604		8431206206040	99090604		8431206906049	99000604	Please consult	8431206006046
600 x 500	2,484	6	99010605		8431206106050	99020605		8431206206057	99090605		8431206906056	99000605	Consultar	8431206006053
600 x 600	2,895	6	99010606		8431206106067	99020606		8431206206064	99090606		8431206906063			
700 x 200	1,260	6	99010702		8431206107026									
700 x 300	1,674	6	99010703		8431206107033	99020703		8431206207030	99090703		8431206907039	99000703	Consultar	8431206007036
700 x 400	2,089	6	99010704		8431206107040	99020704		8431206207047	99090704		8431206907046	99000704	Please consult	8431206007043
700 x 500	2,861	6	99010705		8431206107057	99020705		8431206207054	99090705		8431206907053	99000705	Consultar	8431206007050
700 x 600	3,334	6	99010706		8431206107064	99020706		8431206207061	99090706		8431206907060			
800 x 200	1,426	6	99010802		8431206108023									
800 x 300	1,895	6	99010803		8431206108030	99020803		8431206208037	99090803		8431206908036	99000803	Consultar	8431206008033
800 x 400	2,364	6	99010804		8431206108047	99020804		8431206208044	99090804		8431206908043	99000804	Please consult	8431206008040
800 x 500	3,238	6	99010805		8431206108054	99020805		8431206208051	99090805		8431206908050	99000805	Consultar	8431206008057
800 x 600	3,774	6	99010806		8431206108061	99020806		8431206208068	99090806		8431206908067			
800 x 700	4,310	6	99010807		8431206108078									
900 x 200	1,592	6	99010902		8431206109020									
900 x 300	2,115	6	99010903		8431206109037	99020903		8431206209034	99090903		8431206909033	99000903	Consultar	8431206009030
900 x 400	2,639	6	99010904		8431206109044	99020904		8431206209041	99090904		8431206909040	99000904	Please consult	8431206009047
900 x 500	3,614	6	99010905		8431206109051	99020905		8431206209058	99090905		8431206909057	99000905	Consultar	8431206009054
900 x 600	4,213	6	99010906		8431206109068	99020906		8431206209065	99090806		8431206908064			
900 x 700	4,811	6	99010907		8431206109075									
1000 x 200	1,758	6	99011002		8431206110026									
1000 x 300	2,336	6	99011003		8431206110033	99021003		8431206210030	99091003		8431206910039	99001003	Consultar	8431206010036
1000 x 400	2,914	6	99011004		8431206110040	99021004		8431206210047	99091004		8431206910046	99001004	Please consult	8431206010043
1000 x 500	3,991	6	99011005		8431206110057	99021005		8431206210054	99091005		8431206910053	99001005	Consultar	8431206010050
1000 x 600	4,652	6	99011006		8431206110064	99021006		8431206210061	99091006		8431206910060			
1000 x 700	5,313	6	99011007		8431206110071									
1100 x 300*	2,922	6							99091103		8431206911036			
1100 x 400*	3,645	6							99091104		8431206911043			
1100 x 500*	4,368	6							99091105		8431206911050			
1100 x 600*	5,091	6							99091106		8431206911067			
1200 x 300*	3,174	6							99091203		8431206912033			
1200 x 400*	3,960	6							99091204		8431206912040			
1200 x 500*	4,745	6							99091205		8431206912057			
1200 x 600*	5,531	6							99091206		8431206912064			

(*) Consultar disponibilidad / Consult availability / Consult stock



ángulo ranurado

slotted angle shelving / angle cranté

sistemas de almacenaje y mobiliario para vestuario y colectividades
storage systems and furniture for locker rooms and community buildings • systèmes de stockage et équipements pour vestiaires et collectivités

estanterías
JOMASI

tornillos / bolts / boulons

Artículo Item Article	Peso k Weight k Poids k	Unidades Envase Units Pack Unités Emballage	Referencia Reference Référence	€/Envase €/Pack €/Emballage	Cod. EAN EAN Code Code EAN
Tornillo M8 x 16 ZC M8 x 16 ZC Bolt Boulon M8 x 16 ZC	0,586	Blister 40 40 Blister pack Blister 40	99010001		8431206100010
Tornillo M8 x 16 ZC M8 x 16 ZC Bolt Boulon M8 x 16 ZC	2,945	Caja 200 200 Box Boîte 200	99010003		8431206100034
Tornillo M8 x 16 Inox. M8 x 16 Inox. Bolt Boulon M8 x 16 Inox.	---	1	99000005		8431206000051



escuadra galvanizada / galvanized corner piece / équerre galvanisée

Artículo Item Article	Peso k Weight k Poids k	Unidades Envase Units Pack Unités Emballage	Referencia Reference Référence	€/Envase €/Pack €/Emballage	Cod. EAN EAN Code Code EAN
Escuadra galvanizada Galvanized corner piece Equerre galvanisée	0,200	Blister 8 8 Blister pack Blister 8	99090006		8431206900061
Escuadra galvanizada Galvanized corner piece Equerre galvanisée	2,700	Caja 100 100 Box Boîte 100	99090007		8431206900078
Escuadra galvanizada Galvanized corner piece Equerre galvanisée	30,000	Saco 1200 1200 Bag Sac 1200	99090009		---
Escuadra inoxidable Stainless corner piece Equerre inoxydable	---	1	99000010		8431206000105



contenedores / bands / conteneurs

gris / grey / gris

Artículo item Article	Peso k Weight k Poids k	Unidades Paquete Units Package Unités Paquet	Referencia Reference Référence	€/Unidad €/Unit €/Unité	Cod. EAN EAN Code Code EAN
Delantero 600 / Front / Avant	0,427	10	99010042		8431206100423
Delantero 700 / Front / Avant	0,500	10	90010043		8431206100430
Delantero 800 / Front / Avant	0,572	10	99010044		8431206100447
Delantero 900 / Front / Avant	0,645	10	99010045		8431206100454
Delantero 1000 / Front / Avant	0,717	10	99010046		8431206100461
Trasero 600 / Back / Arrière	0,803	10	99010052		8431206100522
Trasero 700 / Back / Arrière	0,939	10	90010053		8431206100539
Trasero 800 / Back / Arrière	1,076	10	99010054		8431206100546
Trasero 900 / Back / Arrière	1,212	10	99010055		8431206100553
Trasero 1000 / Back / Arrière	1,349	10	99010056		8431206100560



divisores de contenedor / band dividers / séparateurs de conteneur

galvanizado / galvanized / galvanisée

Artículo Item Article	Peso k Weight k Poids k	Unidades Paquete Units Package Unités Paquet	Referencia Reference Référence	€/Unidad €/Unit €/Unité	Cod. EAN EAN Code Code EAN
Divisor 200 / Divider / Séparateur	0,179	20	99090062		8431206900627
Divisor 300 / Divider / Séparateur	0,270	20	99090063		8431206900634
Divisor 400 / Divider / Séparateur	0,361	20	99090064		8431206900641
Divisor 500 / Divider / Séparateur	0,452	20	99090065		8431206900658
Divisor 600 / Divider / Séparateur	0,543	20	99090066		8431206900665

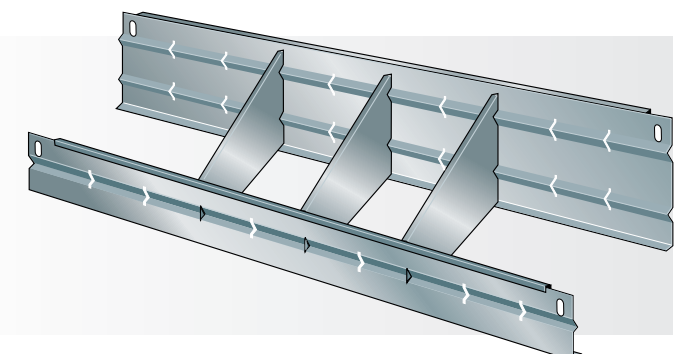

divisores de pestaña / wall dividers / séparateurs d'onglet

gris / grey / gris

Artículo PxH Item DxH Article PxH	Peso k Weight k Poids k	Uds. Paquete Units Package Unités Paquet	Referencia Reference Référence	€/Unidad €/Unit €/Unité	Cod. EAN EAN Code Code EAN
Divisor 200 x 250H Divider / Séparateur	0,528	1	99010072		8431206100720
Divisor 300 x 250H Divider / Séparateur	0,572	1	99010073		8431206100737
Divisor 400 x 250H Divider / Séparateur	0,751	1	99010074		8431206100744
Divisor 500 x 250H Divider / Séparateur	0,932	1	99010075		8431206100751
Divisor 600 x 250H Divider / Séparateur	1,112	1	99010076		8431206100768

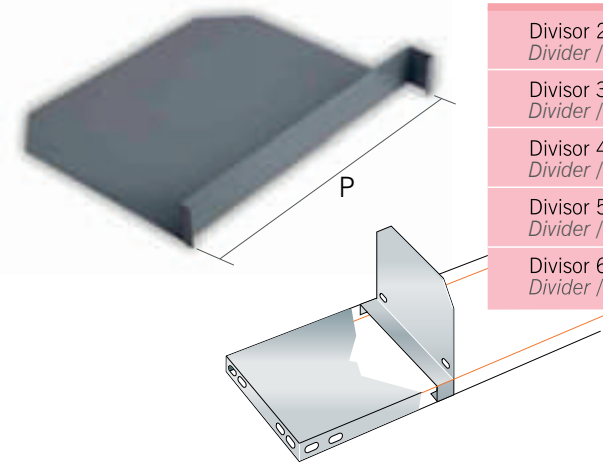

cajones / bins / tiroirs

gris / grey / gris

Artículo PxA Item DxW Article PxA	Peso k Weight k Poids k	Uds. Paquete Units Package Unités Paquet	Referencia Reference Référence	€/Unidad €/Unit €/Unité	Cod. EAN EAN Code Code EAN
C/300 x 200	0,873	8	99010083		8431206100836
C/300 x 270	1,056	6	99010084		8431206100843
C/400 x 200	1,099	8	99010085		8431206100850
C/400 x 270	1,318	6	99010086		8431206100867
C/500 x 200	1,324	8	99010087		8431206100874
C/500 x 270	1,580	6	99010088		8431206100881

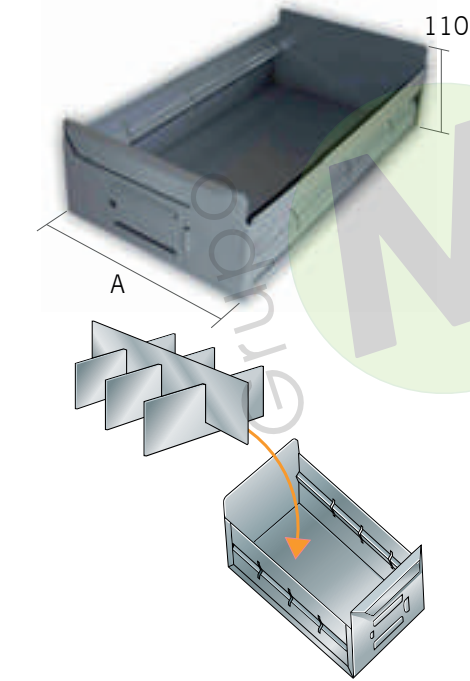

divisores de cajón

bin dividers / séparateurs de tiroir

galvanizado / galvanized / galvanisée

Artículo L Item L Article L	Peso k Weight k Poids k	Uds. Paquete Units Package Unités Paquet	Referencia Reference Référence	€/Unidad €/Unit €/Unité	Cod. EAN EAN Code Code EAN
Transversal 200 Width-wise / Transversal	0,080	---	99090091		8431206900917
Transversal 270 Width-wise / Transversal	0,107	---	99090092		8431206900924
Longitudinal 300 Depth-wise / Longitudinal	0,107	---	99090093		8431206900931
Longitudinal 400 Depth-wise / Longitudinal	0,149	---	99090094		8431206900948
Longitudinal 500 Depth-wise / Longitudinal	0,190	---	99090095		8431206900955

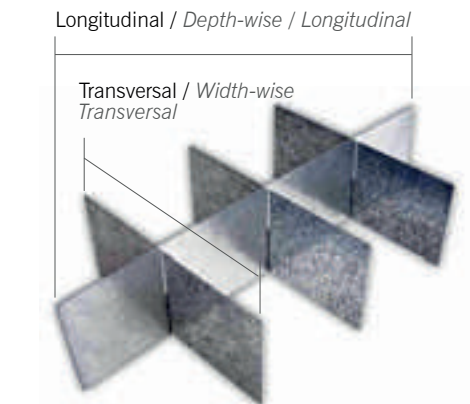

refuerzos para baldas

shelf stiffeners / renforts de tablettes

gris / grey / gris

Artículo L Item L Article L	Peso k Weight k Poids k	Uds. Paquete Units Package Unités Paquet	Referencia Reference Référence	€/Unidad €/Unit €/Unité	Cod. EAN EAN Code Code EAN
R. Soldado/ 800 Welded stiffener / R.Soudé	---	---	99010104		---
R. Soldado 900 Welded stiffener / R.Soudé	---	---	99010105		---
R. Soldado 1000 Welded stiffener / R.Soudé	---	---	99010106		---
R. Atornillado 600 Bolted stiffener / R.Vissé	0,351	10	99010112		8431206101123
R. Atornillado 700 Bolted stiffener / R.Vissé	0,411	10	99010113		8431206101130
R. Atornillado 800 Bolted stiffener / R.Vissé	0,470	10	99010114		8431206101147
R. Atornillado 900 Bolted stiffener / R.Vissé	0,530	10	99010115		8431206101154
R. Atornillado 1000 Bolted stiffener / R.Vissé	0,590	10	99010116		8431206101161

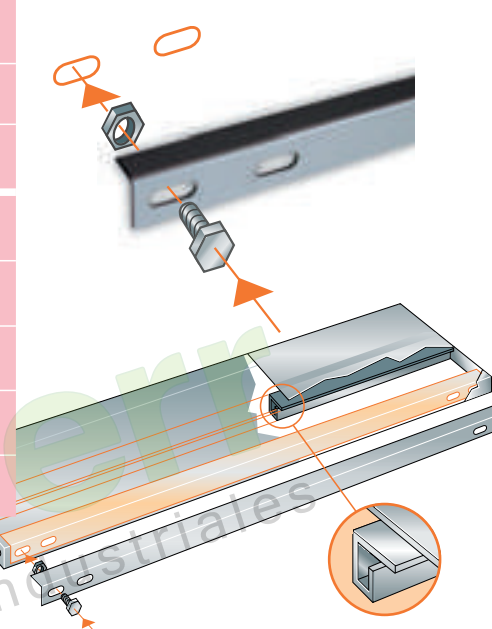

chapas laterales y frontales

side and front plates / tôles latérales et avant

gris / grey / gris

Artículo LxH Item LxH Article LxH	Peso k Weight k Poids k	Uds. Paquete Units Package Unités Paquet	Referencia Reference Référence	€/Unidad €/Unit €/Unité	Cod. EAN EAN Code Code EAN
Chapa 200 x 1000H Plate / Tôle	0,876	1	99010122		843206101222
Chapa 300 x 1000H Plate / Tôle	1,337	1	99010123		843206101239
Chapa 400 x 1000H Plate / Tôle	1,798	1	99010124		843206101246
Chapa 500 x 1000H Plate / Tôle	2,259	1	99010125		843206101253
Chapa 600 x 1000H Plate / Tôle	2,720	1	99010126		843206101260
Chapa 700 x 1000H Plate / Tôle	3,158	1	99010127		843206101277
Chapa 800 x 1000H Plate / Tôle	3,619	1	99010128		843206101284
Chapa 900 x 1000H Plate / Tôle	4,080	1	99010129		843206101291
Chapa 1000 x 1000H Plate / Tôle	4,541	1	99010130		843206101307

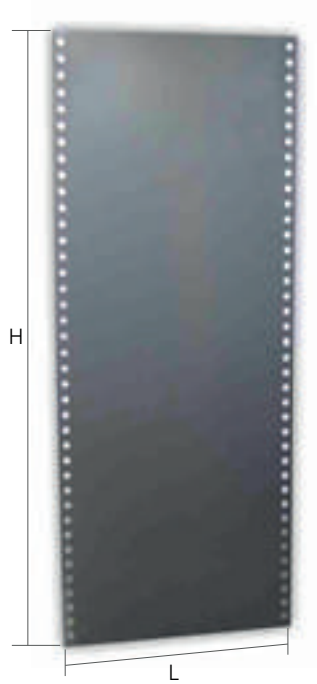

Artículo Item Article	Peso k Weight k Poids k	Unidades Paquete Units Package Unités Paquet	Referencia Reference Référence	€/Unidad €/Unit €/Unité	Cod. EAN EAN Code Code EAN
Hogar 3.30	5,588	1	97009003		8431206090038
Hogar 4.30	7,992	1	97015004		8431206150046

hogar 3.30	unidades units / unités
	4 900 mm
	4
	3 750 x 300 mm
	24

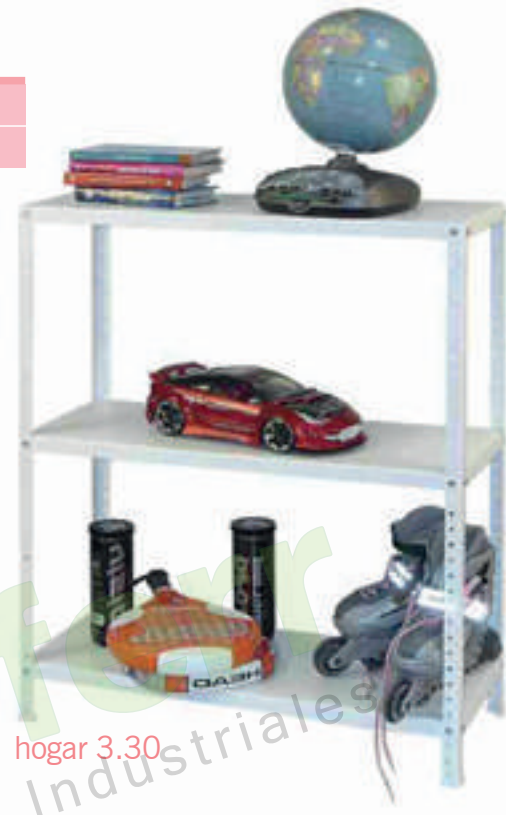

hogar 3.30



hogar 5.30

Artículo Item Article	Peso k Weight k Poids k	Unidades Paquete Units Package Unités Paquet	Referencia Reference Référence	€/Unidad €/Unit €/Unité	Cod. EAN EAN Code Code EAN
Hogar 5.30	9,584	1	97016505		8431206165057
Hogar 6.30	11,176	1	97018006		8431206180067

hogar 5.30	unidades units / unités
	4 1650 mm
	4
	5 750 x 300 mm
	40

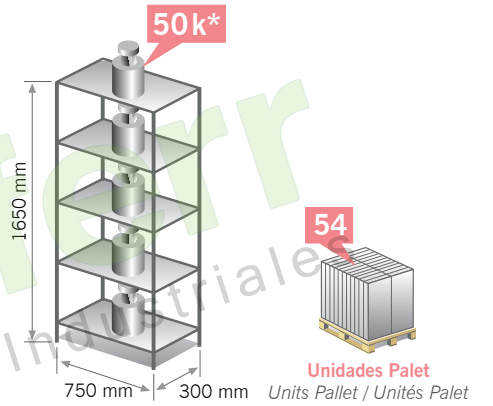

hogar 5.30

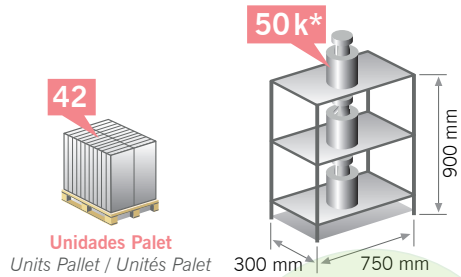

Unidades Palet
Units Pallet / Unités Palet



hogar 4.30

hogar 4.30	unidades units / unités
	4 1500 mm
	4
	4 750 x 300 mm
	32

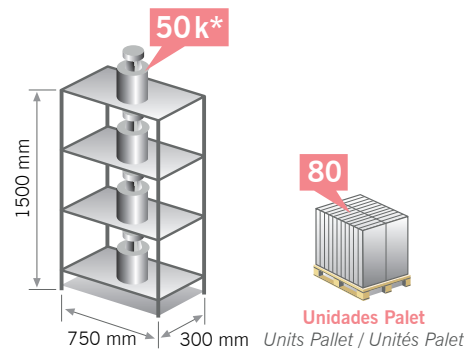

Unidades Palet
Units Pallet / Unités Palet

Hasta/Up to/Jusqu'à

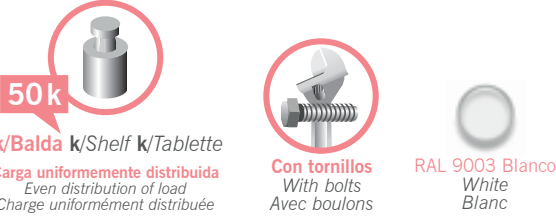

k/Balda k/Shelf k/Tablette
Carga uniformemente distribuida
Even distribution of load
Charge uniformément distribuée

Con tornillos
With bolts
Avec boulons

RAL 9003 Blanco
White
Blanc

hogar 6.30	unidades units / unités
	4 1800 mm
	4
	6 750 x 300 mm
	48

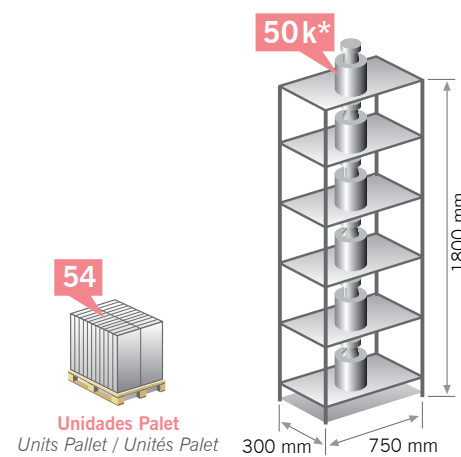

Unidades Palet
Units Pallet / Unités Palet



hogar 6.30

Artículo Item Article	Peso k Weight k Poids k	Unidades Paquete Units Package Unités Paquet	Referencia Reference Référence	€/Unidad €/Unit €/Unité	Cod. EAN EAN Code Code EAN
Oficina 3.30	6,332	1	98003090		8431206030904
Oficina 4.30	9,520	1	98004180		8431206041801

oficina 3.30	unidades units / unités
	4 900 mm
	4
	3 900 x 300 mm
	24

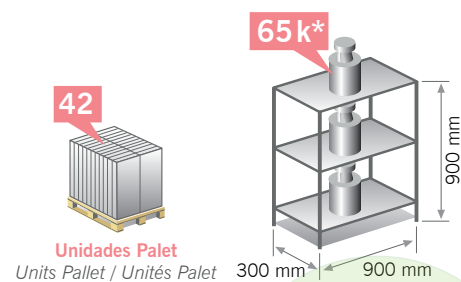

Artículo Item Article	Peso k Weight k Poids k	Unidades Paquete Units Package Unités Paquet	Referencia Reference Référence	€/Unidad €/Unit €/Unité	Cod. EAN EAN Code Code EAN
Oficina 5.30	11,092	1	98005180		8431206051800
Oficina 6.30	12,664	1	98006180		8431206061809

oficina 5.30	unidades units / unités
	4 1800 mm
	4
	5 900 x 300 mm
	40

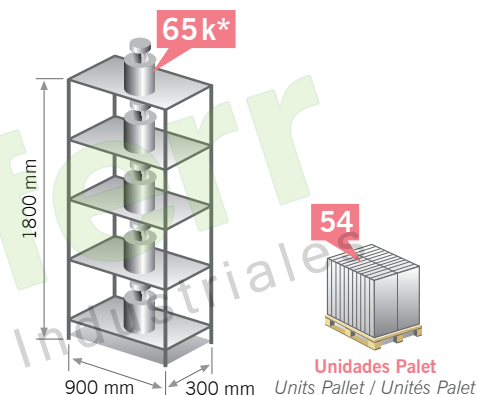

oficina 4.30	unidades units / unités
	4 1800 mm
	4
	4 900 x 300 mm
	32

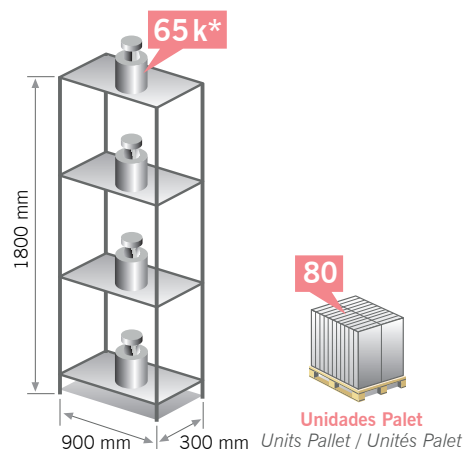

Hasta/Up to/Jusqu'à



k/Balda k/Shelf k/Tablette
Carga uniformemente distribuida
Even distribution of load
Charge uniformément distribuée



Con tornillos
With bolts
Avec boulons

Perfil
Upright / Profilé



RAL 5014 Azul
Blue/Bleu

Balda
Shelf / Tablette



RAL 7035 Gris
Grey/Gris

oficina 6.30	unidades units / unités
	4 1800 mm
	4
	6 900 x 300 mm
	48

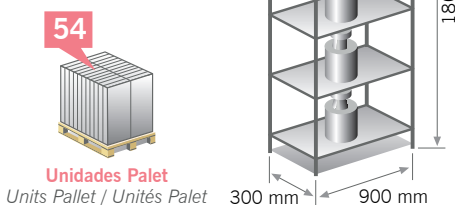

Artículo Item Article	Peso k Weight k Poids k	Unidades Paquete Units Package Unités Paquet	Referencia Reference Référence	€/Unidad €/Unit €/Unité	Cod. EAN EAN Code Code EAN
Almacén 5.30	14,369	1	98017830		8431206178309
Almacén 5.40	16,614	1	98017840		8431206178408

Artículo Item Article	Peso k Weight k Poids k	Unidades Paquete Units Package Unités Paquet	Referencia Reference Référence	€/Unidad €/Unit €/Unité	Cod. EAN EAN Code Code EAN
Almacén 5.30	14,369	1	98017930		8431206179306
Almacén 5.40	16,614	1	98017940		8431206179405

almacén 5.30

unidades units / unités
8 900 mm
4
5 900 x 300 mm
40

Unidades Palet
Units Pallet / Unités Palet



almacén 5.30

unidades units / unités
8 900 mm
4
5 900 x 300 mm
40

Unidades Palet
Units Pallet / Unités Palet



almacén 5.40

unidades units / unités
8 900 mm
4
5 900 x 400 mm
40

Hasta/Up to/Jusqu'à

75k 85k

k/Balda k/Shelf k/Tablette

Carga uniformemente distribuida
Even distribution of load
Charge uniformément distribuée

Con tornillos
With bolts
Avec boulons

RAL 9003 Blanco
White
Blanc

Gris
Grey
Gris

almacén 5.40

Unidades Palet
Units Pallet / Unités Palet

Transformable en banco de trabajo
It converts into a workbench
Transformable en banque de travail

Gris
Grey
Gris

almacén 5.40

Unidades Palet
Units Pallet / Unités Palet

almacén 5.40

unidades units / unités
8 900 mm
4
5 900 x 400 mm
40



idea 5 sistema de encastre socket system / système d'encastrement

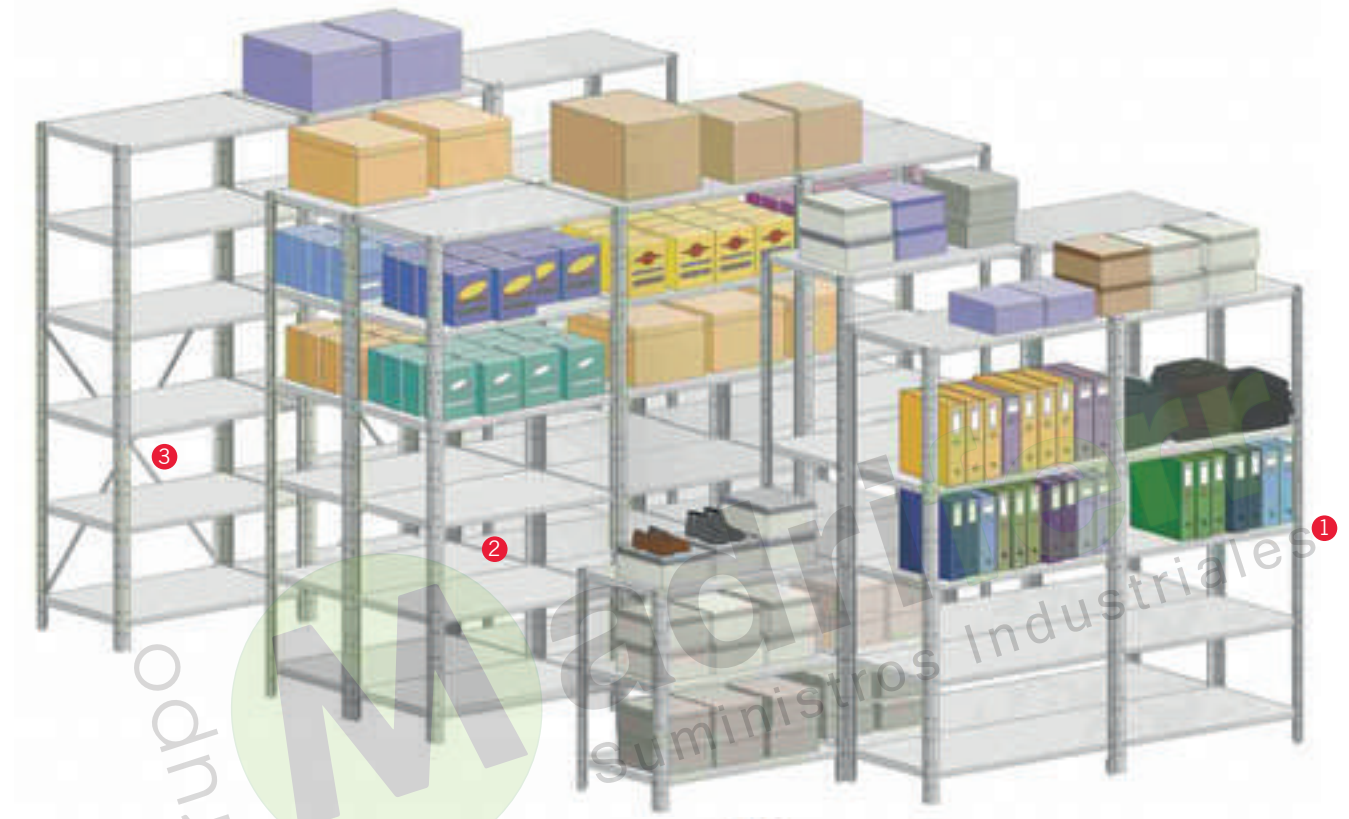

- 1 Perfil / Upright / Profilé
- 2 Balda / Shelf / Tablette
- 3 Cruceta / Crosspiece / Croisillon
- 4 Base metálica / Metal foot / Pied métallique



Una opción orientada hacia el archivo, sin necesidad de recurrir a profesionales del montaje.
Su sistema de fijación es su gran atractivo, permite regular en altura de una manera cómoda y segura.

*An option geared towards file shelving that does not require professional fitting.
Its great advantage is its fixing system which allows convenient, safe height adjustment.*

*Une option orientée vers l'archivage, qui ne requiert pas d'intervention de professionnels du montage.
Son système de fixation est son grand atout, il permet de régler en hauteur d'une façon pratique et sûre.*

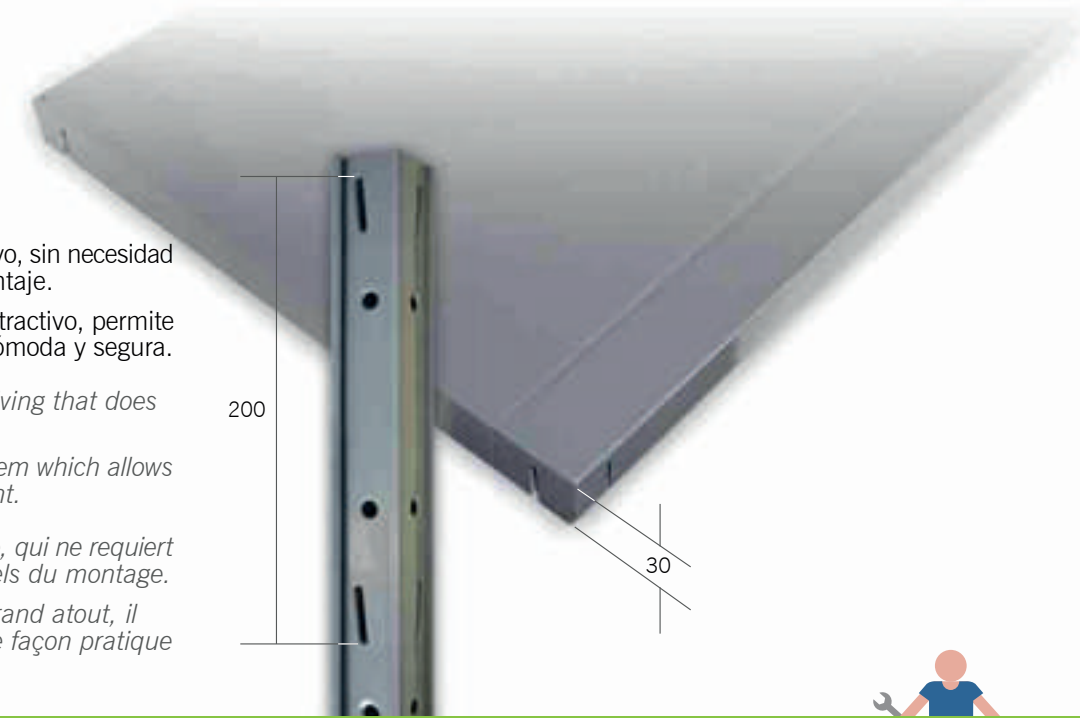

perfiles / uprights / profilés

RAL 7037 gris / grey / gris

Artículo L Item L Article L	Peso k Weight k Poids k	Uds. Paquete Units Package Unités Paquet	Capacidad k Capacity k Capacité k	Referencia Reference Référence	€/Unidad €/Unit €/Unité	Cod. EAN EAN Code Code EAN
SE/33 de 1000	0,700	10	1000*	79013310		8431206793106
SE/33 de 1600	1,050	10	1000*	79013316		8431206793168
SE/33 de 2000	1,400	10	1000*	79013320		8431206793205
SE/33 de 2400	1,680	10	1000*	79013324		8431206793243
SE/33 de 3000	2,100	10	1000*	79013330		8431206793304

* Carga admisible (cuatro perfiles) con una distancia de 400 mm entre baldas / Corte a medida perfil: 0,30 €/neto
 *Allowable load (four uprights) with a distance of 400 mm between shelves / Upright cut-to-size: 0.30 €/net
 * Charge admissible (quatre profilés) à une distance de 400 mm entre tablettes / Coupe sur mesure profilé: 0,30 €/net

El perfil Idea 5 tiene un plegado en ambos lados que permite el enganche de otros perfiles para montar así una estantería de una o de dos caras, dando la posibilidad de componer un único perfil en cruz.

El perfil tiene aletas inclinadas hacia el ángulo que permiten un ajuste perfecto de la balda a lo largo y a lo ancho.

The Idea 5 upright has a fold on both sides which enables other uprights to engage in it. In this way a shelving unit with one or two faces can be mounted, with the possibility of forming a unique crossed upright.

The upright has angled wing pieces allowing perfect adjustment of the shelf along the whole of its length and width.

Le profilé Idea 5 dispose d'un pliage des deux côtés permettant d'accrocher d'autres profilés pour monter ainsi un rayonnage à une ou deux faces, donnant la possibilité de composer un seul profil en croix.

Le profilé a des ailettes inclinées vers l'angle qui permettent un réglage parfait de la tablette sur toute la longueur et la largeur.



accesorios / accessories / accessoires

galvanizado / galvanized / galvanisée

Artículo L Item L Article L	Peso k Weight k Poids k	Uds. Paquete Units Package Unités Paquet	Referencia Reference Référence	€/Unidad €/Unit €/Unité	Cod. EAN EAN Code Code EAN
Base metálica Metal foot Pied métallique	0,040	4	79010049		8431206790495
Cruceta Crosspiece / Croisillon	0,450	1	79010050		8431206790501



baldas / shelves / tablettes

RAL 7037 gris / grey / gris

Artículo LxP Item LxD Description LxP	Peso k Weight k Poids k	Uds. Paquete Units Package Unités Paquet	Capacidad k Capacity k Capacité k	Referencia Reference Référence	€/Unidad €/Unit €/Unité	Cod. EAN EAN Code Code EAN
800 x 300	1,550	5	100*	79010803		8431206790839
800 x 400 1R	2,370	5	140*	79010804		8431206790846
800 x 500 1R	3,205	5	140*	79010805		8431206790853
800 x 600 2R	3,940	5	150*	79010806		8431206790860
1000 x 300	1,870	5	90*	79011003		8431206791034
1000 x 400 1R	2,950	5	130*	79011004		8431206791041
1000 x 500 1R	3,865	5	130*	79011005		8431206791058
1000 x 600 2R	4,995	5	140*	79011006		8431206791065
1200 x 300	2,230	5	80*	79011203		8431206791232
1200 x 400 1R	3,490	5	120*	79011204		8431206791249
1200 x 500 1R	4,630	5	120*	79011205		8431206791256
1200 x 600 2R	6,005	5	130*	79011206		8431206791263

* Carga uniformemente distribuida
 * Even distribution of load
 * Charge uniformément distribuée

La balda es de una pieza. En la parte superior tiene nervios longitudinales embutidos, que le dan una mayor robustez y linealidad. La balda tiene unas aberturas oblicuas en las paredes verticales, cerca de las esquinas, que permiten el encastre en los perfiles.

La balda tiene 3 cm. de altura y un plegado en la parte longitudinal, para evitar accidentes durante el desplazamiento y montaje, aumentando así su capacidad de carga.

The shelf comes in one piece. The top has recessed longitudinal ribs which give it greater strength and linearity. The shelf has oblique openings in its vertical walls, near to the corners to slot the uprights into place.

The shelf is 3 cm high with a longitudinal fold to prevent accidents when moving and assembling it and to increase the load-bearing capacity of the shelf.

La tablette est en une seule pièce. Sur la partie supérieure, elle dispose de nervures longitudinales embouties qui lui donnent une plus grande robustesse et linéarité. La tablette dispose d'ouvertures obliques sur les parois verticales, près des angles, permettant l'encastrement dans les profilés.

La tablette a 3 cm de hauteur et un pliage sur la partie longitudinale, afin d'éviter les accidents durant le déplacement et le montage, augmentant ainsi sa capacité de charge.

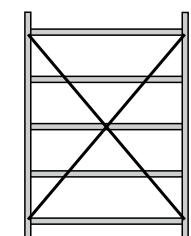

El arriostramiento sirve para estabilizar la estantería en el sentido longitudinal y se aconseja colocar uno en cada módulo si la altura supera los 2000 mm. Para módulos múltiples, coloque una cruceta cada 3 módulos.

Bracing provides the shelving with greater stability. It is recommended to fit modules that are more than 2000 mm high with a longitudinal brace. For multiple modules, fit a crosspiece every 3 modules.

Le contreventement sert à stabiliser le rayonnage dans le sens longitudinal et il est recommandé d'en placer un sur chaque module si la hauteur dépasse les 2000 mm. Pour les modules multiples, placez un croisillon tous les 3 modules.

Artículo Item Article	Peso k Weight k Poids k	Unidades Paquete Units Package Unités Paquet	Referencia Reference Référence	€/Unidad €/Unit €/Unité	Cod. EAN EAN Code Code EAN
Idea 5.30	9,770	1	78000021		8431206780212
Idea 5.40	13,300	1	78000030		8431206780304

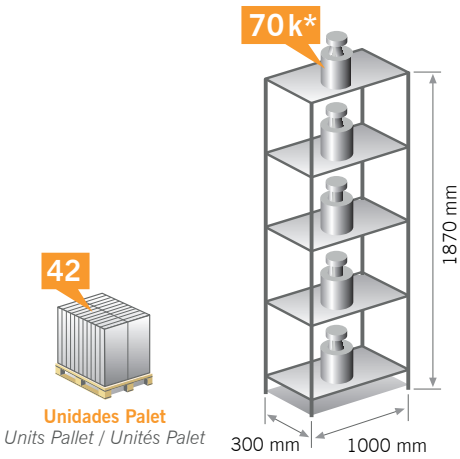

idea 5.30	unidades units / unités
	8 935 mm
	4
	5 1000 x 300 mm



idea 5.30

Artículo Item Article	Peso k Weight k Poids k	Unidades Paquete Units Package Unités Paquet	Referencia Reference Référence	€/Unidad €/Unit €/Unité	Cod. EAN EAN Code Code EAN
Idea 5.30	9,770	1	78000024		8431206780243
Idea 5.40	13,300	1	78000033		8431206780335

idea 5.30	unidades units / unités
	8 935 mm
	4
	5 1000 x 300 mm

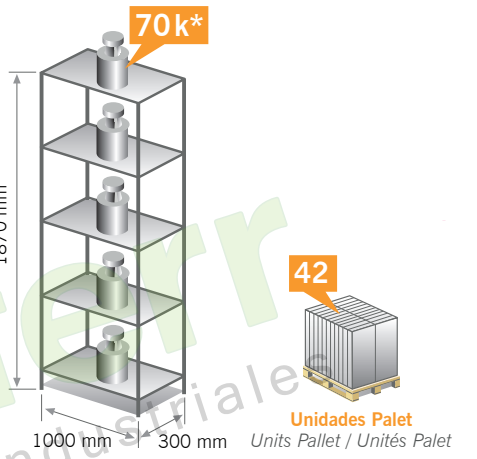

idea 5.30



idea 5.40

idea 5.40	unidades units / unités
	8 935 mm
	4
	5 1000 x 400 mm

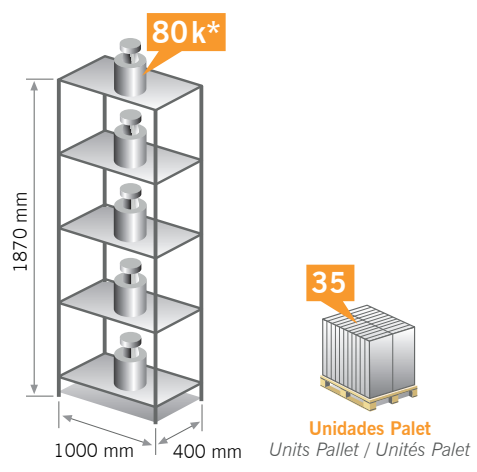

Hasta/Up to/Jusqu'à

70k 80k

k/Balda k/Shelf k/Tablette

Carga uniformemente distribuida
Even distribution of load
Charge uniformément distribuée

Sin tornillos
Without bolts
Sans boulons

Con martillo
With hammer
Avec marteau

Transformable en banco de trabajo
It converts into a workbench
Transformable en banque de travail

Galvanizado
Galvanized
Galvanisée

idea 5.40	unidades units / unités
	8 935 mm
	4
	5 1000 x 400 mm



idea 5.40

cromo

chrome / chromé

- 1 Balda / Shelf / Tablette
- 2 Poste / Post / Poteau
- 3 Pie regulable / Adjustable foot / Pied réglable
- 4 Semiconos / Semi cones / Semi cône



Unión postes
Post coupling
Union poteaux



Pie regulable*
Adjustable foot*
Pied réglable*

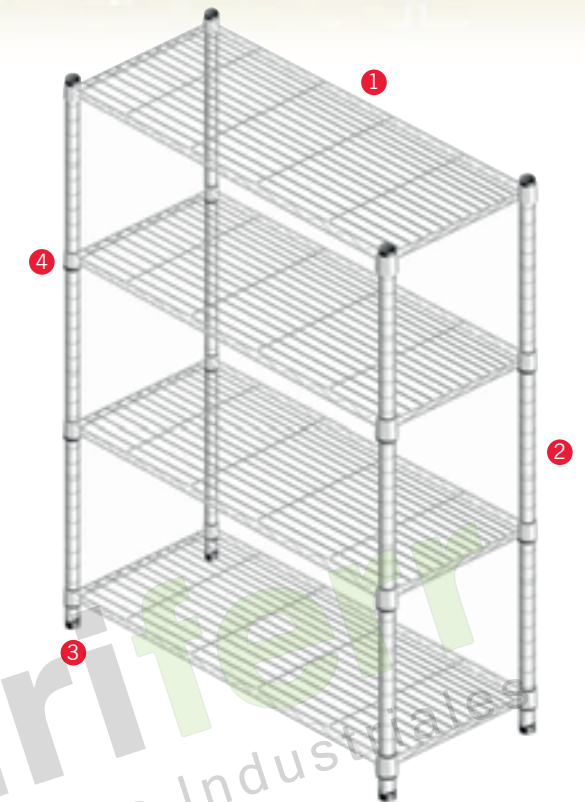

postes / posts / poteaux

cromado / chrome / chromé

Artículo LxP Item LxD/Article LxP	Peso k Weight k/Poids k	Unidades Paquete Units Package/Unités Paquet	Referencia Reference/Référence	€/Unidad €/Unit/€/Unité	Cod. EAN EAN Code/Code EAN
900	0,630	4	19072509		8431206725091
1600	1,130	4	19072516		8431206725169
1800	1,260	4	19072518		8431206725183

(*) Incluidos / Included / Inclus



Detalle montaje
Assembly details
Détail assemblage



Semiconos*
Semi cones*
Semi cône*

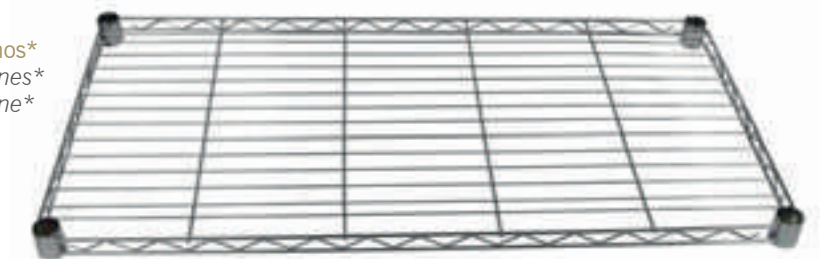

baldas / shelves / tablettes

cromado / chrome / chromé

Artículo LxP Item LxD/Article LxP	Peso k Weight k/Poids k	Unidades Paquete Units Package/Unités Paquet	Referencia Reference/Référence	€/Unidad €/Unit/€/Unité	Cod. EAN EAN Code/Code EAN
750 x 350	1,720	5	19070703		8431206707035
750 x 450	2,020	5	19070704		8431206707042
900 x 350	1,920	5	19070903		8431206709039
900 x 450	2,320	5	19070904		8431206709046
1200 x 350	2,120	5	19071203		8431206712039
1200 x 450	2,720	5	19071204		8431206712046

(*) Incluidos / Included / Inclus.

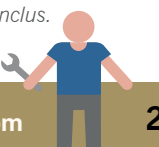









Artículo Item Article	Peso k Weight k Poids k	Unidades Paquete Units Package Unités Paquet	Referencia Reference Référence	€/Unidad €/Unit €/Unité	Cod. EAN EAN Code Code EAN
CROMO 3.35	9,300	1	19070335		8431206703358
CROMO 4.35	12,700	1	19070435		8431206704355
CROMO 5.35	15,700	1	19070535		8431206705352

cromo 3.35	unidades units/unités
	4 900 mm
	24
	3 900 x 350 mm
	4



cromo 3.35

65k*	cromo 5.35	unidades units/unités
		8 900 mm
		40
		5 900 x 350 mm
		4

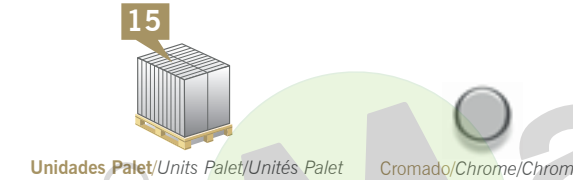

cromo 4.35



cromo 5.35

cromo 4.35	unidades units/unités
	8 800 mm
	32
	4 900 x 350 mm
	4

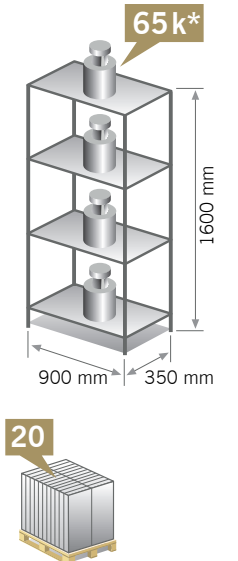

Unidades Palet/Units Pallet/Unités Palet

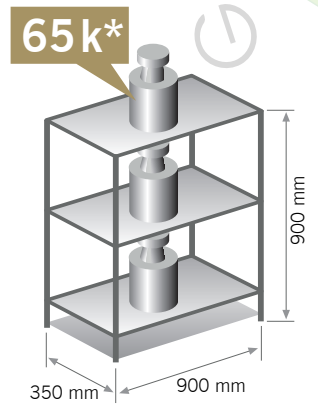

Hasta/Up to/Jusqu'à
65k
k/Balda k/Shelf k/Tablette
Carga uniformemente distribuida
Even distribution of load
Charge uniformément distribuée

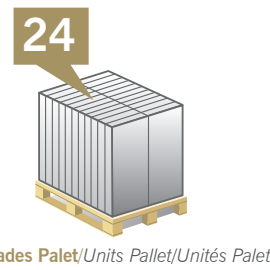

Unidades Palet/Units Pallet/Unités Palet



Pie regulable*
Adjustable foot*
Pied réglable*



Sin tornillos
Without bolts
Sans boulons





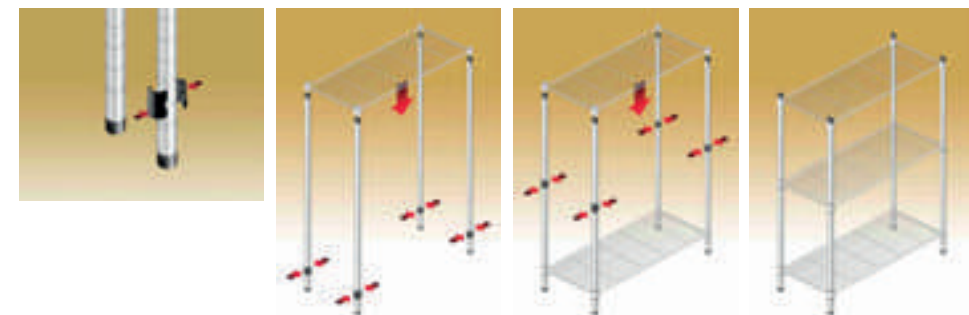

Sin herramienta
Without tool
Sans outil



Artículo Item Article	Peso k Weight k Poids k	Unidades Paquete Units Package Unités Paquet	Referencia Reference Référence	€/Unidad €/Unit €/Unité	Cod. EAN EAN Code Code EAN
CROMO 3.45	11,700	1	19070345		8431206703457
CROMO 4.45	14,700	1	19070445		8431206704454
CROMO 5.45	17,700	1	19070545		8431206705451

cromo 3.45	unidades units/unités
	4 900 mm
	24
	3 900 x 450 mm
	4





65k*	cromo 5.45	unidades units/unités
		8 900 mm
		40
		5 900 x 450 mm
		4



12	Unidades Palet/Units Pallet/Unités Palet	Cromado/Chrome/Chromé
		

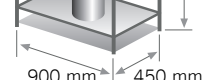
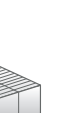

cromo 4.45	unidades units/unités
	8 800 mm
	32
	4 900 x 450 mm
	4

65k*	unidades units/unités
	8 1600 mm
	40
	5 900 x 450 mm
	4

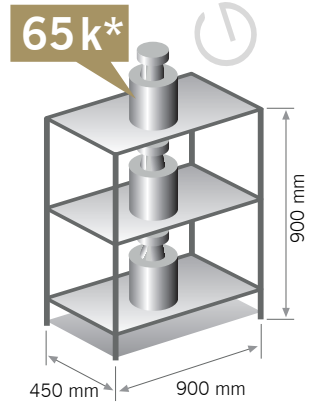

Hasta/Up to/Jusqu'à



k/Balda k/Shelf k/Tablette
 Carga uniformemente distribuida
 Even distribution of load
 Charge uniformément distribuée

20



Unidades Palet/Units Pallet/Unités Palet



Pie regulable*
 Adjustable foot*
 Pied réglable*



Sin tornillos
 Without bolts
 Sans boulons



Sin herramienta
 Without tool
 Sans outil

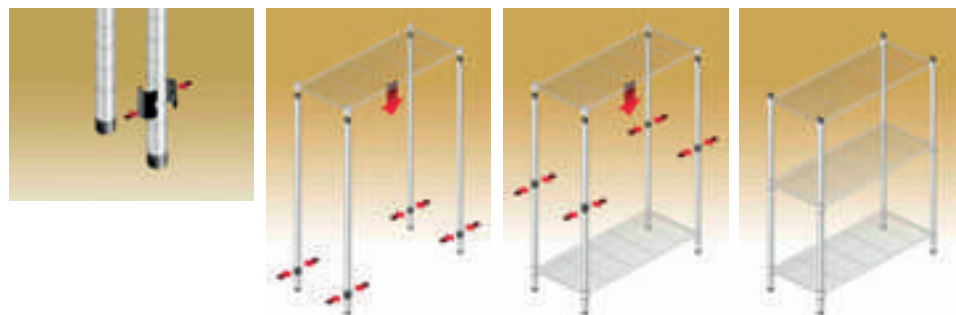

línea blanca

white line / ligne blanche

Grupo **Madriferr**
 Suministros Industriales

- 1 Columna / Column / Colonne
- 2 Pie / Foot / Pied
- 3 Panel fondo liso
Smooth back panel
Panneau fond lisse
- 4 Panel fondo perforado
Perforated back panel
Panneau fond perforé
- 5 Gancho / Hook / Crochet
- 6 Balda / Shelf / Tablette
- 7 Cartela / Bracket / Gousset
- 8 Zócalo / Base / Socle
- 9 Visera hueca / Hollow header / Bandeau creux
- 10 Portaprecios
Price holder / Porte-étiquette de prix

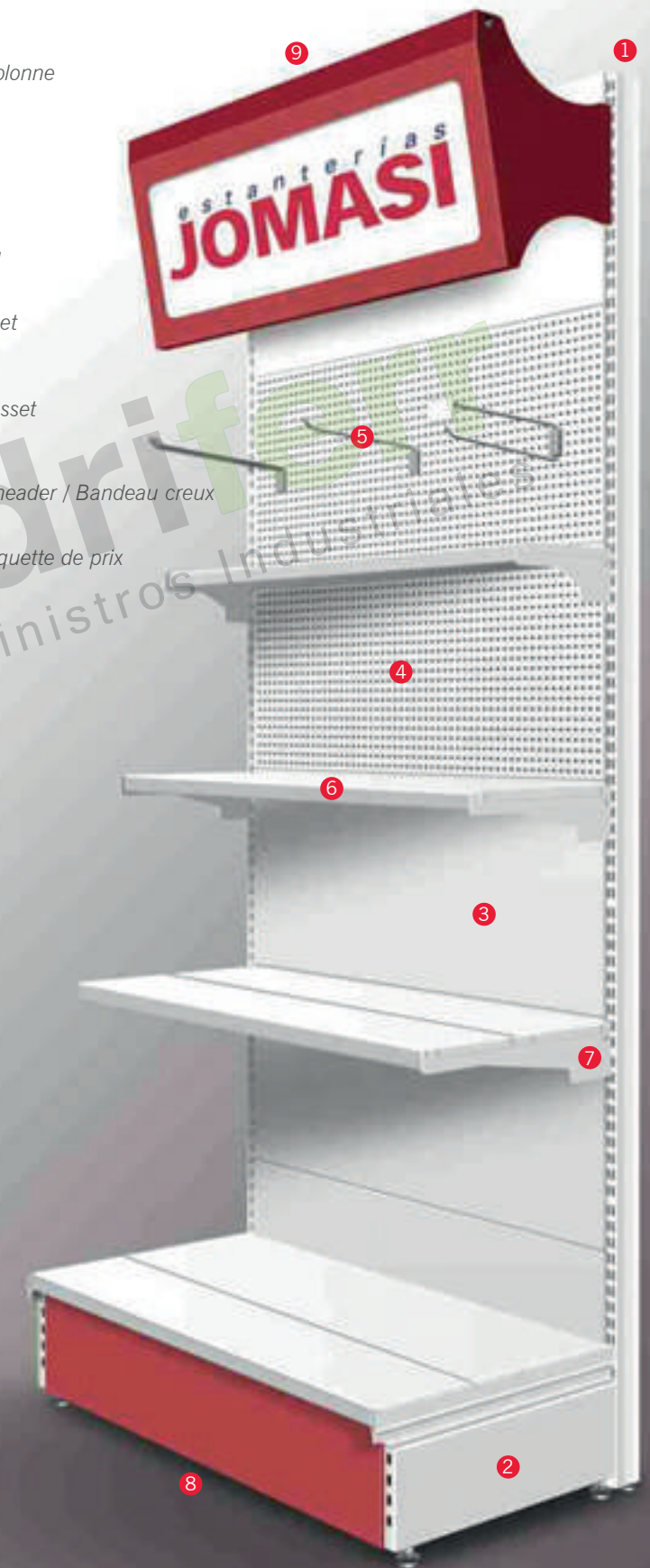
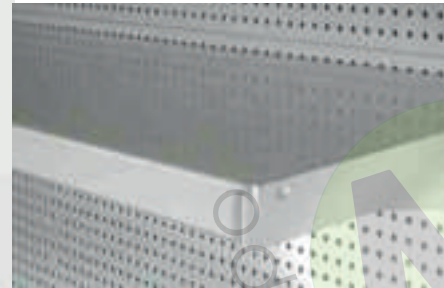

Línea Blanca, sinónimo de estantería para equipamiento de comercios.

Su diseño y una gran variedad de accesorios, permite cubrir las necesidades de cualquier negocio.

White Line, a by-word in shelving for commercial establishments.

Its design and wide range of accessories meet the requirements of all types of businesses.

Ligne Blanche, synonyme de rayonnage pour équipements de commerce.

Sa conception et la grande variété des accessoires permettent de répondre aux besoins de tous les types de commerces.



cremallera (sujeción a pared)

RAL 9003 blanco / white / blanc

rack (wall attachment) / crémaillère (fixation au mur)

Artículo L Item L Article L	Peso k Weight k Poids k	Uds. Paquete Units Package Unités Paquet	Referencia Reference Référence	€/Unidad €/Unit €/Unité	Cod. EAN EAN Code Code EAN
1000	1,410	10	CSP1000		8431206300212
1200	1,692	10	CSP1200		8431206300229
1400	1,974	10	CSP1400		8431206300236
1600	2,256	10	CSP1600		8431206300243
1800	2,538	10	CSP1800		8431206300250
2000	2,820	10	CSP2000		8431206300267
2200	3,102	10	CSP2200		8431206300274
2400	3,384	10	CSP2400		8431206300281

Tornillos y tacos no incluidos / Screws and wall plugs not included / Vis et chevilles non inclus



Artículo L Item L Article L	Peso k Weight k Poids k	Uds. Envase Units Pack Unités Emballage	Referencia Reference Référence	€/Envase €/Pack €/Emballage	Cod. EAN EAN Code Code EAN
Tornillo y taco Screws and wall Vis et chevilles	0,115	50	T445	8,90	8431206300304

columna de 60 (góndola y mural)

RAL 9003 blanco / white / blanc

60 column (gondola and wall) / colonne de 60 (carter et murale)

Artículo L Item L Article L	Peso k Weight k Poids k	Uds. Paquete Units Package Unités Paquet	Referencia Reference Référence	€/Unidad €/Unit €/Unité	Cod. EAN EAN Code Code EAN
1000	2,700	2	C601000		8431206300410
1200	3,240	2	C601200		8431206300427
1400	3,780	2	C601400		8431206300434
1600	4,320	2	C601600		8431206300441
1800	4,860	2	C601800		8431206300458
2000	5,400	2	C602000		8431206300465
2200	5,940	2	C602200		8431206300472
2400	6,480	2	C602400		8431206300489

Pie regulable incluido / Adjustable foot included / Pied réglable inclus

Contera Ferrule / Cache	0,009	10	CT6030		8431206300502
----------------------------	-------	----	--------	--	---------------

pie bajo de columna 150h (góndola y mural)

150h low column foot (gondola and wall) / pied de colonne bas 150h (carter et murale)

Artículo P Item D Article P	Peso k Weight k Poids k	Uds. Paquete Units Package Unités Paquet	Referencia Reference Référence	€/Unidad €/Unit €/Unité	Cod. EAN EAN Code Code EAN
200	0,836	2	PB200		8431206300823
300	1,200	2	PB300		8431206300830
400	1,566	2	PB400		8431206300847
500	1,930	2	PB500		8431206300854
600	2,296	2	PB600		8431206300861

Pie regulable incluido / Adjustable foot included / Pied réglable inclus

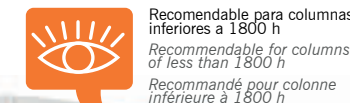

Recomendable para columnas inferiores a 1800 h
Recommendable for columns of less than 1800 h
Recommandé pour colonne inférieure à 1800 h

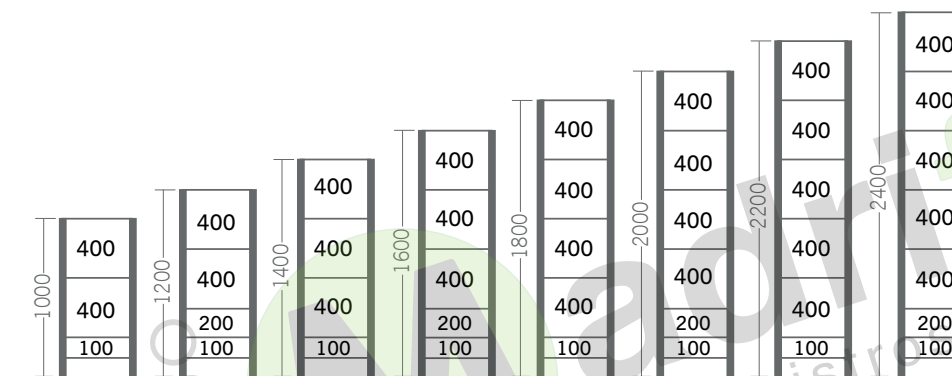

Composición de paneles con pie bajo / Panel composition with low foot / Composition de panneau à pied bas

Incluidos / Included / Inclus

pie alto de columna 250h (góndola y mural)

250h high column foot (gondola and mural) / pied de colonne haut 250h (carter et murale)

RAL 9003 blanco / white / blanc

Artículo P Item D Article P	Peso k Weight k Poids k	Uds. Paquete Units Package Unités Paquet	Referencia Reference Référence	€/Unidad €/Unit €/Unité	Cod. EAN EAN Code Code EAN
200	1,348	2	PA200		8431206301028
300	1,936	2	PA300		8431206301035
400	2,526	2	PA400		8431206301042
500	3,114	2	PA500		8431206301059
600	3,704	2	PA600		8431206301066

Pie regulable incluido / Adjustable foot included / Pied réglable inclus

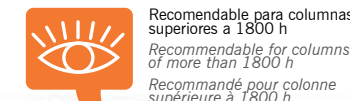

Recomendable para columnas superiores a 1800 h
Recommendable for columns of more than 1800 h
Recommandé pour colonne supérieure à 1800 h

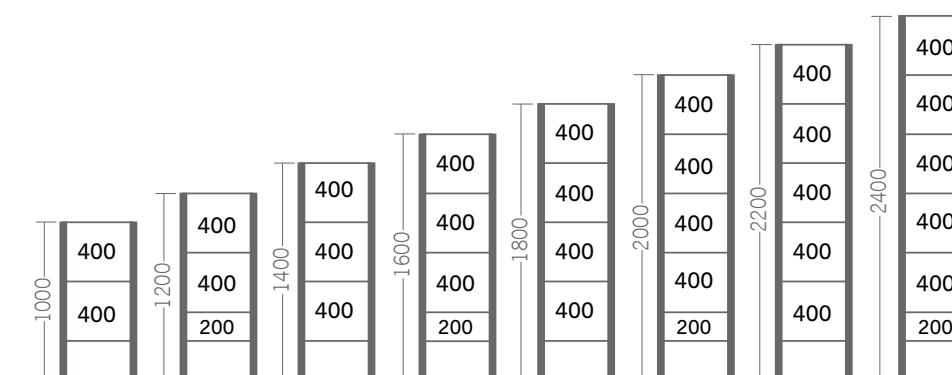

Composición de paneles con pie alto / Panel composition with high foot / Composition de panneau à pied haut

Incluidos / Included / Inclus



panel fondo liso 100h

100h smooth back panel / panneau fond lisse 100h RAL 9003 blanco / white / blanc

Artículo LxH Item LxH Article LxH	Peso k Weight k Poids k	Uds. Paquete Units Package Unités Paquet	Referencia Reference Référence	€/Unidad €/Unit €/Unité	Cod. EAN EAN Code Code EAN
550 x 100	0,460	6	PFL0550100		8431206301219
700 x 100	0,582	6	PFL0700100		8431206301226
850 x 100	0,704	6	PFL0850100		8431206301233
1000 x 100	0,826	6	PFL1000100		8431206301240
1150 x 100	0,948	6	PFL1150100		8431206301257
1300 x 100	1,070	6	PFL1300100		8431206301264

panel fondo liso 200h

200h smooth back panel / panneau fond lisse 200h RAL 9003 blanco / white / blanc

Artículo LxH Item LxH Article LxH	Peso k Weight k Poids k	Uds. Paquete Units Package Unités Paquet	Referencia Reference Référence	€/Unidad €/Unit €/Unité	Cod. EAN EAN Code Code EAN
550 x 200	0,768	6	PFL0550200		8431206301318
700 x 200	0,972	6	PFL0700200		8431206301325
850 x 200	1,175	6	PFL0850200		8431206301332
1000 x 200	1,379	6	PFL1000200		8431206301349
1150 x 200	1,583	6	PFL1150200		8431206301356
1300 x 200	1,786	6	PFL1300200		8431206301363

panel fondo liso 400h

400h smooth back panel / panneau fond lisse 400h RAL 9003 blanco / white / blanc

Artículo LxH Item LxH Article LxH	Peso k Weight k Poids k	Uds. Paquete Units Package Unités Paquet	Referencia Reference Référence	€/Unidad €/Unit €/Unité	Cod. EAN EAN Code Code EAN
550 x 400	1,384	6	PFL0550400		8431206301516
700 x 400	1,751	6	PFL0700400		8431206301523
850 x 400	2,118	6	PFL0850400		8431206301530
1000 x 400	2,484	6	PFL1000400		8431206301547
1150 x 400	2,851	6	PFL1150400		8431206301554
1300 x 400	3,218	6	PFL1300400		8431206301561

panel fondo liso rinconera 100/200/400h

100/200/400h smooth back panel, corner
 panneau fond lisse angle 100/200/400h RAL 9003 blanco / white / blanc

Artículo LxH Item LxH Article LxH	Peso k Weight k Poids k	Uds. Paquete Units Package Unités Paquet	Referencia Reference Référence	€/Unidad €/Unit €/Unité	Cod. EAN EAN Code Code EAN
730 x 100	0,616	6	PFLR100		8431206301615
730 x 200	1,029	6	PFLR200		8431206301622
730 x 400	1,853	6	PFLR400		8431206301646
910 x 100*	0,761	6	PFLR10060		8431206301714
910 x 200*	1,270	6	PFLR20060		8431206301721
910 x 400*	2,289	6	PFLR40060		8431206301745

(* Panel para pie de 600 / Panel for 600 foot / Panneau pour pied de 600)

panel fondo perforado 400h

400h perforated back panel / panneau fond perforé 400h RAL 9003 blanco / white / blanc

Artículo LxH Item LxH Article LxH	Peso k Weight k Poids k	Uds. Paquete Units Package Unités Paquet	Referencia Reference Référence	€/Unidad €/Unit €/Unité	Cod. EAN EAN Code Code EAN
550 x 400	2,373	6	PFP0550400		8431206302117
700 x 400	3,001	6	PFP0700400		8431206302124
850 x 400	3,630	6	PFP0850400		8431206302131
1000 x 400	4,259	6	PFP1000400		8431206302148
1150 x 400	4,888	6	PFP1150400		8431206302155
1300 x 400	5,517	6	PFP1300400		8431206302162

panel fondo perforado rinconera

perforated back panel, corner
 panneau fond perforé angle RAL 9003 blanco / white / blanc

Artículo LxH Item LxH Article LxH	Peso k Weight k Poids k	Uds. Paquete Units Package Unités Paquet	Referencia Reference Référence	€/Unidad €/Unit €/Unité	Cod. EAN EAN Code Code EAN
730 x 400	3,177	6	PFPR400		8431206302247
910 x 400*	3,924	6	PFPR40060		8431206302346

(* Panel para pie de 600 / Panel for 600 foot / Panneau pour pied de 600)

ganchos / hooks / crochets

cromado / chrome / chromé

Artículo L Item L Article L	Peso k Weight k Poids k	Uds. Paquete Units Package Unités Paquet	Referencia Reference Référence	€/Unidad €/Unit €/Unité	Cod. EAN EAN Code Code EAN
200 - Ø 6	0,071	25	GSC-620		8431206302407
250 - Ø 6	0,083	25	GSC-625		8431206302414
300 - Ø 6	0,095	25	GSC-630		8431206302421
350 - Ø 6	0,110	25	GSC-635		8431206302438
200 - Ø 5	0,095	25	GDC-520		8431206302445
250 - Ø 5	0,125	25	GDC-525		8431206302452
300 - Ø 5	0,160	25	GDC-530		8431206302469
200 - Ø 6	0,130	25	GSEC-620		8431206302476
250 - Ø 6	0,150	25	GSEC-625		8431206302483
300 - Ø 6	0,175	25	GSEC-630		8431206302490
350 - Ø 6	0,195	25	GSEC-635		8431206302506

tapajuntas / flashing / couvre-joints

RAL 9003 blanco / white / blanc

Artículo L Item L Article L	Peso k Weight k Poids k	Uds. Paquete Units Package Unités Paquet	Referencia Reference Référence	€/Unidad €/Unit €/Unité	Cod. EAN EAN Code Code EAN
550	0,279	6	TP600550		8431206305613
700	0,360	6	TP600700		8431206305620
850	0,441	6	TP600850		8431206305637
1000	0,522	6	TP601000		8431206305644
1150	0,603	6	TP601150		8431206305651
1300	0,683	6	TP601300		8431206305668

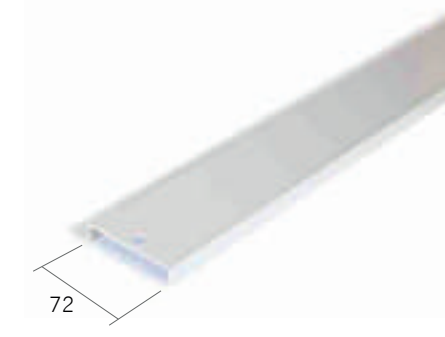
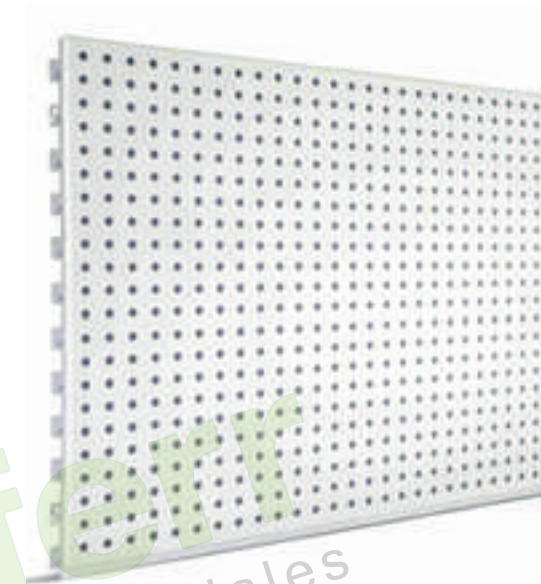

balda / shelf / tablette

RAL 9003 blanco / white / blanc

Artículo LxD Item LxD Article LxP	Peso k Weight k Poids k	Uds. Paquete Units Package Unités Paquet	Referencia Reference Référence	€/Unidad €/Unit €/Unité	Cod. EAN EAN Code Code EAN
550 x 200	0,886	6	B0550200		8431206302629
550 x 300	1,206	6	B0550300		8431206302636
700 x 200	1,114	6	B0700200		8431206302728
700 x 300	1,516	6	B0700300		8431206302735
850 x 200	1,343	6	B0850200		8431206302827
850 x 300	1,827	6	B0850300		8431206302834
1000 x 200	1,571	6	B1000200		8431206302926
1000 x 300	2,138	6	B1000300		8431206302933
1150 x 200	1,799	6	B1150200		8431206303022
1150 x 300	2,449	6	B1150300		8431206303039
1300 x 200	2,027	6	B1300200		8431206303121
1300 x 300	2,759	6	B1300300		8431206303138

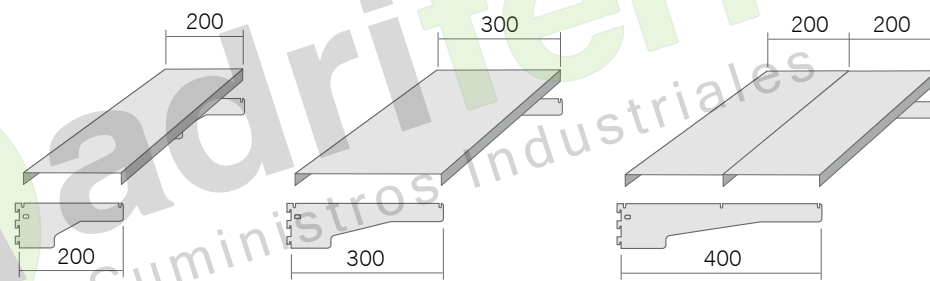

balda rinconera

corner shelf / tablette angle

RAL 9003 blanco / white / blanc

Artículo P Item D Article P	Peso k Weight k Poids k	Uds. Paquete Units Package Unités Paquet	Referencia Reference Référence	€/Unidad €/Unit €/Unité	Cod. EAN EAN Code Code EAN
200	0,899	6	BR200		8431206303220
300	1,199	6	BR300		8431206303237
400	1,500	6	BR400		8431206303244
500	1,577	6	BR500		8431206303251



Balda rinconera de 600, consultar 600 corner shelf, please consult us. / Tablette angle de 600, consulter

balda chaflán

chamfered corner shelf / tablette chanfrein

RAL 9003 blanco / white / blanc

Artículo P Item D Article P	Peso k Weight k Poids k	Uds. Paquete Units Package Unités Paquet	Referencia Reference Référence	€/Unidad €/Unit €/Unité	Cod. EAN EAN Code Code EAN
200	0,459	6	BCH200		8431206303329
300	0,731	6	BCH300		8431206303336
400	0,858	6	BCH400		8431206303343
500	1,139	6	BCH500		8431206303350



Balda chaflán de 600, consultar 600 chamfered corner shelf, please consult us. / Tablette pour chanfrein de 600, consulter

cartela recta

straight bracket / gousset droit

RAL 9003 blanco / white / blanc

Artículo L Item L Article L	Peso k Weight k Poids k	Uds. Paquete Units Package Unités Paquet	Referencia Reference Référence	€/Unidad €/Unit €/Unité	Cod. EAN EAN Code Code EAN
200	0,206	20	CR200		8431206304029
300	0,291	20	CR300		8431206304036
400	0,375	20	CR400		8431206304043
500	0,726	20	CR500		8431206304050
600	0,860	20	CR600		8431206304067

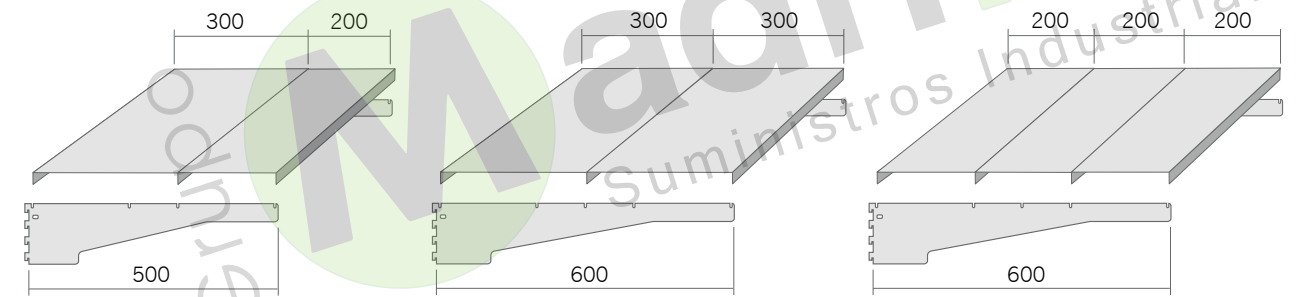

ÁNGULO INTERIOR 90° Rinconera
90° inner angle, corner
Angle intérieur 90°

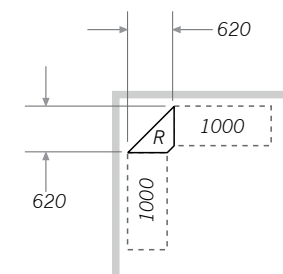

ÁNGULO EXTERIOR 90° Chaflán
90° external angle, chamfer
Angle extérieur 90° Chanfrein

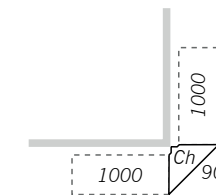

portaprecios / price holder / porte-étiquette de prix

Artículo L Item L Article L	Peso k Weight k Poids k	Uds. Paquete Units Package Unités Paquet	Referencia Reference Référence	€/Unidad €/Unit €/Unité	Cod. EAN EAN Code Code EAN
550	0,040	10	PVC-E0550		8431206303411
700	0,052	10	PVC-E0700		8431206303428
850	0,064	10	PVC-E0850		8431206303435
1000	0,076	10	PVC-E1000		8431206303442
1150	0,088	10	PVC-E1150		8431206303459
1300	0,100	10	PVC-E1300		8431206303466



cartela inclinada

angled bracket / gousset plié

RAL 9003 blanco / white / blanc

Artículo L Item L Article L	Peso k Weight k Poids k	Uds. Paquete Units Package Unités Paquet	Referencia Reference Référence	€/Unidad €/Unit €/Unité	Cod. EAN EAN Code Code EAN
200	0,221	20	CI200		8431206304128
300	0,323	20	CI300		8431206304135
400	0,424	20	CI400		8431206304142
500	0,807	20	CI500		8431206304159
600	0,962	20	CI600		8431206304166



cartela doblada (madera y cristal)

folded bracket (wood and glass) / gousset plié (bois et verre)

RAL 9003 blanco / white / blanc

Artículo L Item L Article L	Peso k Weight k Poids k	Uds. Paquete Units Package Unités Paquet	Referencia Reference Référence	€/Unidad €/Unit €/Unité	Cod. EAN EAN Code Code EAN
200	0,240	10	CD200		8431206304227
300	0,341	10	CD300		8431206304234
400	0,443	10	CD400		8431206304241

Ventosa no incluida / Suction cup not included / Ventouse non inclus

Artículo L Item L Article L	Peso k Weight k Poids k	Uds. Paquete Units Package Unités Paquet	Referencia Reference Référence	€/Unidad €/Unit €/Unité	Cod. EAN EAN Code Code EAN
Ventosa Suction cup / Ventouse	---	20	VG		---



zócalo bajo / low base / socle bas

RAL 9003 blanco / white / blanc

Artículo LxH Item LxH Article LxH	Peso k Weight k Poids k	Uds. Paquete Units Package Unités Paquet	Referencia Reference Référence	€/Unidad €/Unit €/Unité	Cod. EAN EAN Code Code EAN
550 x 85	0,458	6	ZB0550		8431206305019
700 x 85	0,580	6	ZB0700		8431206305026
850 x 85	0,702	6	ZB0850		8431206305033
1000 x 85	0,824	6	ZB1000		8431206305040
1150 x 85	0,946	6	ZB1150		8431206305057
1300 x 85	1,068	6	ZB1300		8431206305064



zócalo alto / high base / socle haut

RAL 9003 blanco / white / blanc

Artículo LxH Item LxH Article LxH	Peso k Weight k Poids k	Uds. Paquete Units Package Unités Paquet	Referencia Reference Référence	€/Unidad €/Unit €/Unité	Cod. EAN EAN Code Code EAN
550 x 185	0,764	6	ZA0500		8431206305316
700 x 185	0,968	6	ZA0700		8431206305323
850 x 185	1,171	6	ZA0850		8431206305330
1000 x 185	1,375	6	ZA1000		8431206305347
1150 x 185	1,578	6	ZA1150		8431206305354
1300 x 185	1,782	6	ZA1300		8431206305361



zócalo bajo rinconera

low base, corner / socle bas angle

RAL 9003 blanco / white / blanc

Artículo LxH Item LxH Article LxH	Peso k Weight k Poids k	Uds. Paquete Units Package Unités Paquet	Referencia Reference Référence	€/Unidad €/Unit €/Unité	Cod. EAN EAN Code Code EAN
485 x 85	0,418	6	ZBR200		8431206305125
335 x 85	0,296	6	ZBR300		8431206305132
185 x 85	0,173	6	ZBR400		8431206305149
85 x 85	0,093	6	ZBR500		8431206305156
75 x 85	0,084	6	ZBR600		8431206305163



zócalo alto rinconera

high base, corner / socle haut angle

RAL 9003 blanco / white / blanc

Artículo LxH Item LxH Article LxH	Peso k Weight k Poids k	Uds. Paquete Units Package Unités Paquet	Referencia Reference Référence	€/Unidad €/Unit €/Unité	Cod. EAN EAN Code Code EAN
485 x 185	0,698	6	ZAR200		8431206305422
335 x 185	0,494	6	ZAR300		8431206305439
185 x 185	0,289	6	ZAR400		8431206305446
85 x 185	0,155	6	ZAR500		8431206305453
75 x 185	0,140	6	ZAR600		8431206305460

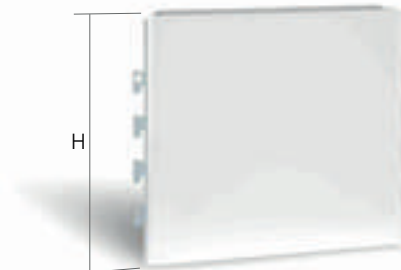

zócalo bajo chaflán

low base, chamfer / socle bas chanfrein

RAL 9003 blanco / white / blanc

Artículo LxH Item LxH Article LxH	Peso k Weight k Poids k	Uds. Paquete Units Package Unités Paquet	Referencia Reference Référence	€/Unidad €/Unit €/Unité	Cod. EAN EAN Code Code EAN
360 x 85	0,325	6	ZBCH200		8431206305224
500 x 85	0,440	6	ZBCH300		8431206305231
640 x 85	0,555	6	ZBCH400		8431206305248
780 x 85	0,670	6	ZBCH500		8431206305255
920 x 85	0,785	6	ZBCH600		8431206305262



zócalo alto chaflán

high base, chamfer / socle haut chanfrein

RAL 9003 blanco / white / blanc

Artículo LxH Item LxH Article LxH	Peso k Weight k Poids k	Uds. Paquete Units Package Unités Paquet	Referencia Reference Référence	€/Unidad €/Unit €/Unité	Cod. EAN EAN Code Code EAN
360 x 185	0,542	6	ZACH200		8431206305521
500 x 185	0,734	6	ZACH300		8431206305538
640 x 185	0,926	6	ZACH400		8431206305545
780 x 185	1,118	6	ZACH500		8431206305552
920 x 185	1,310	6	ZACH600		8431206305569





visera ferretería

hardware header / bandeau quincaillerie métallique

RAL 5010 azul / blue / bleu
RAL 3000 rojo / red / rouge

Artículo LxP Item LxD Article LxP	Peso k Weight k Poids k	Uds. Paquete Units Package Unités Paquet	Referencia Reference Référence	€/Unidad €/Unit €/Unité	Cod. EAN EAN Code Code EAN
550 x 300	2,61	1	VHF0550		8431206306016
700 x 300	2,86	1	VHF0700		8431206306023
850 x 300	3,12	1	VHF0850		8431206306030
1000 x 300	3,38	1	VHF1000		8431206306047
1150 x 300	3,64	1	VHF1150		8431206306054
1300 x 300	3,90	1	VHF1300		8431206306061

Metacrilato no incluido / Plexiglass not included / Méthacrylate non inclus
Preparada para instalación de luz / Ready for light installation / Préparée pour installation d'illumination

ganchos*/ hooks / crochets

(*) Consultar página 39 / Consult page 39 / Consulter page 39

colgador enganche directo

RAL 9003 blanco / white / blanc

direct hook-on hanger / patère à accrocher directement

Artículo LxP Item LxD Article LxP	Peso k Weight k Poids k	Uds. Paquete Units Package Unités Paquet	Referencia Reference Référence	€/Unidad €/Unit €/Unité	Cod. EAN EAN Code Code EAN
550 x 300	0,980	1	CLED0550300		8431206306115
700 x 300	1,114	1	CLED0700300		8431206306122
850 x 300	1,248	1	CLED0850300		8431206306139
1000 x 300	1,382	1	CLED1000300		8431206306146
1150 x 300	1,516	1	CLED1150300		8431206306153
1300 x 300	1,650	1	CLED1300300		8431206306160

cesto enganche directo

cincado / galvanized / galvanisée

direct hook-on basket / panier à accrocher directement

Artículo LxP Item LxD Article LxP	Volúmen Volume Volume	Uds. Paquete Units Package Unités Paquet	Referencia Reference Référence	€/Unidad €/Unit €/Unité	Cod. EAN EAN Code Code EAN
550 x 500	0,083	1	CED0550500		8431206306313
700 x 500	0,105	1	CED0700500		8431206306320
850 x 500	0,128	1	CED0850500		8431206306337
1000 x 500	0,150	1	CED1000500		8431206306344
1150 x 500	0,173	1	CED1150500		8431206306351
1300 x 500	0,195	1	CED1300500		8431206306368

divisor cesto enganche directo

cincado / galvanized / galvanisée

direct hook-on basket divider / séparateur panier à accrocher directement

Artículo P Item D Article P	Peso k Weight k Poids k	Uds. Paquete Units Package Unités Paquet	Referencia Reference Référence	€/Unidad €/Unit €/Unité	Cod. EAN EAN Code Code EAN
500	---	1	DCE500		8431206306399

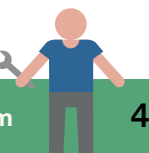

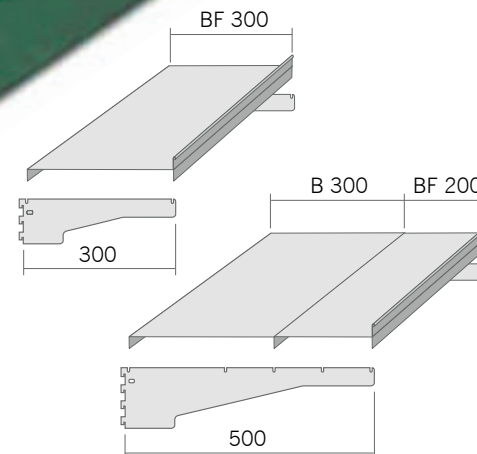
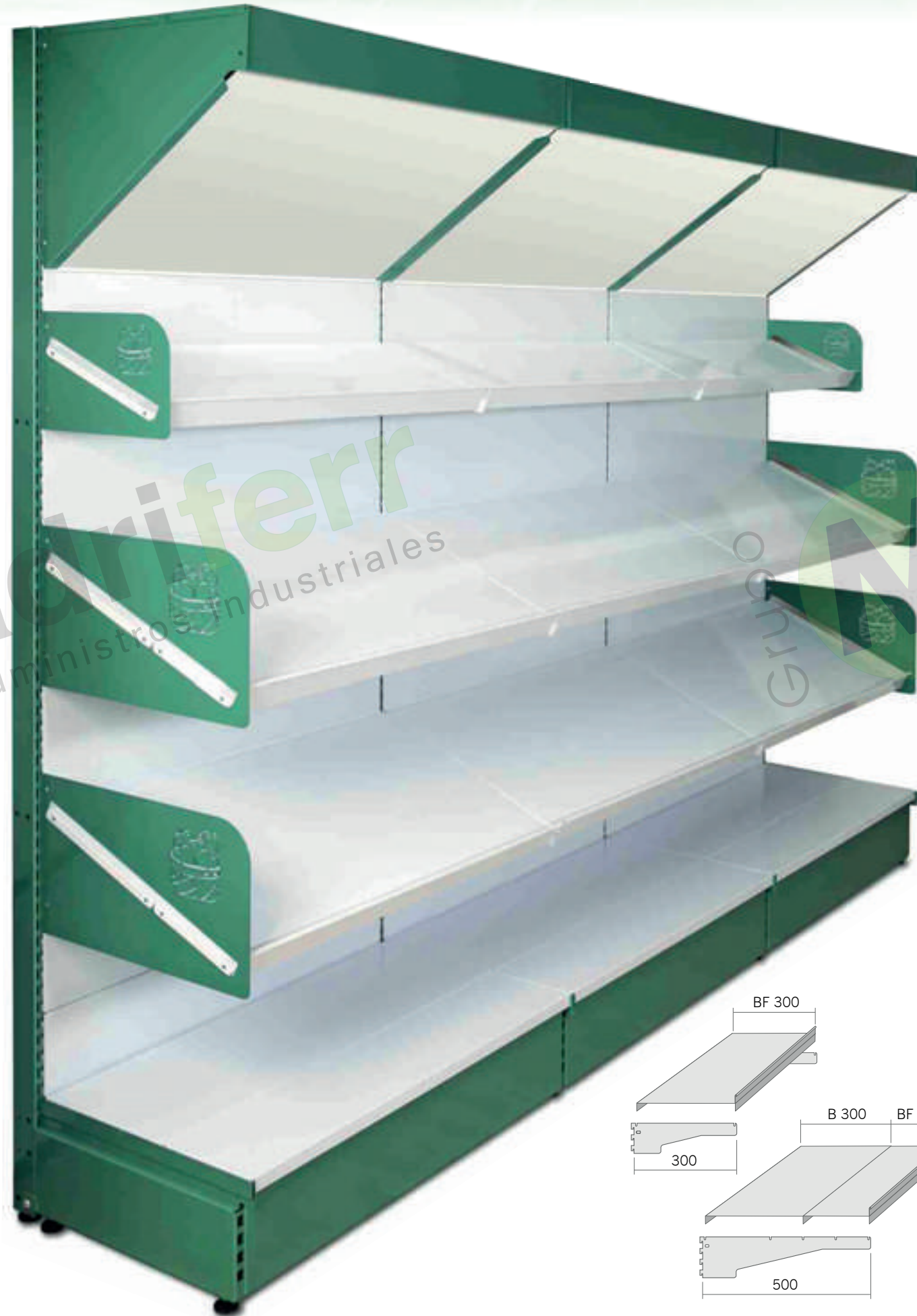
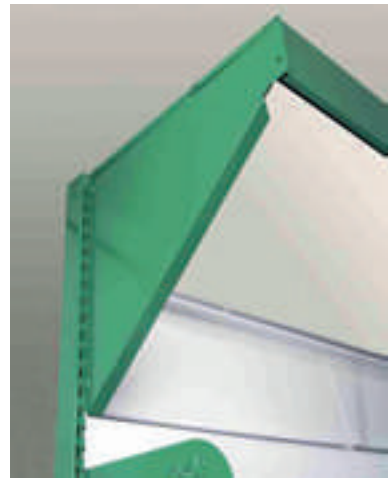

Artículo LxP Item LxD Article LxP	Peso k Weight k Poids k	Uds. Paquete Units Package Unités Paquet	Referencia Reference Référence	€/Unidad €/Unit €/Unité	Cod. EAN EAN Code Code EAN
---	-------------------------------	--	--------------------------------------	-------------------------------	----------------------------------

visera frutería

fruit shop header / bandeau fruits

RAL 6029 verde / green / vert
RAL 2004 naranja / orange / orange

550 x 500	4,287	1	VCF0550		8431206307013
700 x 500	4,993	1	VCF0700		8431206307020
850 x 500	5,702	1	VCF0850		8431206307037
1000 x 500	6,409	1	VCF1000		8431206307044
1150 x 500	7,116	1	VCF1150		8431206307051
1300 x 500	7,823	1	VCF1300		8431206307068

Incluido apoyo para espejo / Including support for mirror / Support de glace inclus
Espejo no incluido / Mirror not included / Glace non inclus

cartela frutería

fruit shop bracket / gousset rayon fruits

RAL 6029 verde / green / vert
RAL 2004 naranja / orange / orange

Artículo L Item L Article L	Peso k Weight k Poids k	Uds. Paquete Units Package Unités Paquet	Referencia Reference Référence	€/Unidad €/Unit €/Unité	Cod. EAN EAN Code Code EAN
300	1,115	2	CDF300		8431206307136
500	2,996	2	CDF500		8431206307150

cartela inclinada*/ angled bracket / gousset plié

(*) Consultar página 42 / Consult page 42 / Consulter page 42

balda frutería

fruit shop shelf / tablette fruits

RAL 9003 blanco / white / blanc

Artículo LxP Item LxD Article LxP	Peso k Weight k Poids k	Uds. Paquete Units Package Unités Paquet	Referencia Reference Référence	€/Unidad €/Unit €/Unité	Cod. EAN EAN Code Code EAN
550 x 200F	1,180	6	BF0550200		8431206307211
550 x 300	1,206	6	B0550300		8431206302636
550 x 300F	1,500	6	BF0550300		8431206307228
700 x 200F	1,489	6	BF0700200		8431206307235
700 x 300	1,516	6	B0700300		8431206302735
700 x 300F	1,891	6	BF0700300		8431206307242
850 x 200F	1,798	6	BF0850200		8431206307259
850 x 300	1,827	6	B0850300		8431206302834
850 x 300F	2,282	6	BF0850300		8431206307266
1000 x 200F	2,106	6	BF1000200		8431206307273
1000 x 300	2,138	6	B1000300		8431206302933
1000 x 300F	2,673	6	BF1000300		8431206307280
1150 x 200F	2,414	6	BF1150200		8431206307297
1150 x 300	2,449	6	B1150300		8431206303039
1150 x 300F	3,064	6	BF1150300		8431206307303
1300 x 200F	2,723	6	BF1300200		8431206307310
1300 x 300	2,759	6	B1300300		8431206303138
1300 x 300F	3,455	6	BF1300300		8431206307327

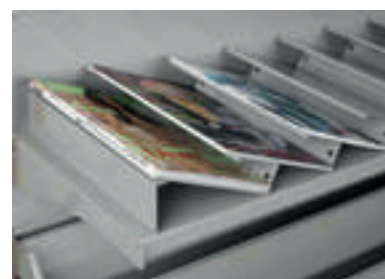

visera papelería

newsagent's header / bandeau papeterie

RAL 3000 rojo / red / rouge
RAL 5010 azul / blue / bleu

Artículo LxP Item LxD Article LxP	Peso k Weight k Poids k	Uds. Paquete Units Package Unités Paquet	Referencia Reference Référence	€/Unidad €/Unit €/Unité	Cod. EAN EAN Code Code EAN
550 x 150	1,65	1	VHP0550		8431206308010
700 x 150	1,87	1	VHP0700		8431206308027
850 x 150	2,09	1	VHP0850		8431206308034
1000 x 150	2,31	1	VHP1000		8431206308041
1150 x 150	2,53	1	VHP1150		8431206308058
1300 x 150	2,75	1	VHP1300		8431206308065

Metacrilato no incluido / Plexiglass not included / Méthacrylate non inclus
Preparada para instalación de luz / Ready for light installation / Préparée pour installation d'illumination

balda revistera

magazine rack / tablette porte-revue

RAL 9003 blanco / white / blanc

Artículo LxH Item LxH Article LxH	Peso k Weight k Poids k	Uds. Paquete Units Package Unités Paquet	Referencia Reference Référence	€/Unidad €/Unit €/Unité	Cod. EAN EAN Code Code EAN
550 x 200	1,375	1	BR0550		8431206308119
700 x 200	1,652	1	BR0700		8431206308126
850 x 200	1,929	1	BR0850		8431206308133
1000 x 200	2,206	1	BR1000		8431206308140
1150 x 200	2,483	1	BR1000		8431206308157
1300 x 200	2,760	1	BR1300		8431206308164

cartela papelería

newsagent's bracket / gousset papeterie

RAL 9003 blanco / white / blanc
RAL 3000 rojo / red / rouge
RAL 5010 azul / blue / bleu

Artículo L Item L Article L	Peso k Weight k Poids k	Uds. Paquete Units Package Unités Paquet	Referencia Reference Référence	€/Unidad €/Unit €/Unité	Cod. EAN EAN Code Code EAN
400	1,574	2	CDP400		8431206308249

balda zig-zag

zigzag shelf / tablette zig-zag

RAL 9003 blanco / white / blanc

Artículo LxP Item LxD Article LxP	Peso k Weight k Poids k	Uds. Paquete Units Package Unités Paquet	Referencia Reference Référence	€/Unidad €/Unit €/Unité	Cod. EAN EAN Code Code EAN
850 x 286	2,157	1	BZZ0850		8431206308331
1000 x 286	2,666	1	BZZ1000		8431206308348

buck para libros y revistas

book and magazine display unit / buck pour livres et revues

RAL 9003 blanco / white / blanc

Artículo LxH Item LxH Article LxH	Peso k Weight k Poids k	Uds. Paquete Units Package Unités Paquet	Referencia Reference Référence	€/Unidad €/Unit €/Unité	Cod. EAN EAN Code Code EAN
550 x 555	8,125	1	BUCK50550		8431206308515
700 x 555	9,621	1	BUCK50700		8431206308522
850 x 555	11,122	1	BUCK50850		8431206308539
1000 x 555	12,617	1	BUCK51000		8431206308546
1150 x 555	14,113	1	BUCK51150		8431206308553
1300 x 555	15,609	1	BUCK51300		8431206308560



mobiliario para vestuario y colectividades



furniture for locker rooms and community buildings
 équipements pour vestiaires et collectivités



Una solución al equipamiento de vestuarios. Volúmenes modulares concebidos para armonizar con el entorno de su ubicación.

An ideal solution for equipping changing rooms. Modular units designed to blend in perfectly with their surroundings.

Une solution à l'équipement des vestiaires. Des volumes modulaires conçus pour s'harmoniser avec l'environnement de leur emplacement.

- 
 1
 Techo inclinado
 Sloping top
 Toit incliné
- 
 2
 Zócalo
 Base
 Socle
- 
 3
 Patas de acero
 Steel legs
 Pieds en acier
- 
 4
 Embellecedor lateral
 Side trim
 Enjoliveur latéral
- 
 5
 Divisor vertical
 Vertical divider
 Séparateur vertical
- 
 6
 Cerradura de candado
 Padlock
 Serrure à cadenas
- 
 7
 Ranura buzón
 Mailbox slot
 Rainure pour boîte à lettres

Para pedidos a portes pagados se entiende por material desmontado, salvo que se haya acordado. La familia "Mobiliario para vestuario y colectividades", la resistencia a la oxidación en los artículos de acero pintado, sólo se garantiza para ambientes secos. Para ambientes húmedos consultar con nuestro departamento comercial.

Carriage paid orders are understood to refer to unmounted material, unless mounting has been agreed. The "Furniture for changing rooms and community buildings", resistance to rusting of the painted steel articles is guaranteed for dry environments. For damp environments please consult with our sales department.

Pour les commandes à ports payés, le matériel est entendu démonté, sauf accord. Pour la famille "Mobilier pour vestiaire et collectivités", la résistance à l'oxydation des articles en acier peint, n'est garantie qu'en environnements secs. Pour les environnements humides, prière de consulter notre département commercial.



armario ropero / wardrobe / armoire garde-robe

Artículo Item Article	Peso k Weight k Poids k	Ancho Width Largueur	Referencia Reference Référence	€/Unidad €/Unit €/Unité	Cod. EAN EAN Code Code EAN
AR250I	23,921	280	6902501I		8431206691013
AR250E	17,248	250	6902501E		8431206691020
AR300I	25,733	330	6903001I		8431206691112
AR300E	19,060	300	6903001E		8431206691129
AR400I	29,357	430	6904001I		8431206691211
AR400E	22,684	400	6904001E		8431206691228

Artículo AR400I y AR400E (Opcional divisor vertical)
Item AR400I and AR400E (Optional vertical divider)
Article AR400I et AR400E (séparateur vertical optionnel)

opciones / options / options

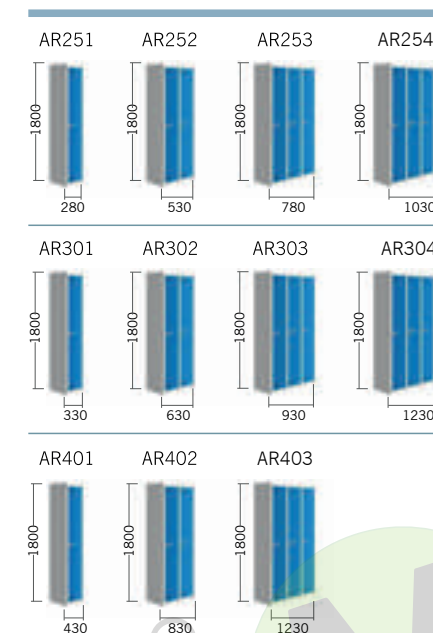

armario ropero grupos

group wardrobes / armoire garde-robe groupes

Artículo Item Article	Peso k Weight k Poids k	Volúmen Volume Volume	Referencia Reference Référence	€/Unidad €/Unit €/Unité	Montaje €/Neto Assembly €/Net Montage €/Net
AR251	23,921	0,262	69002511	83,72	
AR252	41,169	0,496	69002521	152,44	
AR253	58,417	0,730	69002531	221,16	
AR254	75,665	0,964	69002541	289,88	
AR301	25,733	0,309	69003011	90,07	
AR302	44,793	0,590	69003021	165,14	
AR303	63,853	0,870	69003031	240,21	
AR304	82,913	1,151	69003041	315,28	
AR401	29,357	0,402	69004011	102,75	
AR402	52,041	0,777	69004021	190,50	
AR403	74,725	1,151	69004031	278,25	

colores standar

standard colours / couleurs standards

colores opcionales

optional colours / couleurs optionnelles

Puerta door/porte	Cuerpo body/corps						
RAL 5014 azul blue/bleu	RAL 7035 gris grey/gris	RAL 1003 amarillo yellow/jaune	RAL 2004 naranja orange/orange	RAL 3000 rojo red/rouge	RAL 5010 azul blue/bleu	RAL 6029 verde green/vert	RAL 9003 blanco white/blanc

Por razones técnicas de impresión, los colores pueden variar del catálogo con los de nuestros artículos
For technical printing reasons the colours indicated in the catalogue may differ from the actual article colours
Pour des raisons techniques d'impression, les couleurs de nos articles peuvent varier par rapport à celles du catalogue

cambio de color

colour change / changement de couleur

Cantidad mínima para cambio de color, 24 unidades
Minimum quantity for colour change: 24 units
Quantité minimum pour changer de couleur, 24 unités

- Puerta / Door / Porte
Incremento del 5% sobre el precio del artículo
5% increase on article price
Majoration de 5% sur le prix de l'article
- Cuerpo / Body / Corps
Incremento del 10% sobre el precio del artículo
10% increase on article price
Majoration de 10% sur le prix de l'article
- Puerta y Cuerpo / Door and body / Porte et Corps
Incremento del 15% sobre el precio del artículo
15% increase on article price
Majoration de 15% sur le prix de l'article

techos inclinados

sloping tops / toits inclinés

RAL 7035 gris / grey / gris

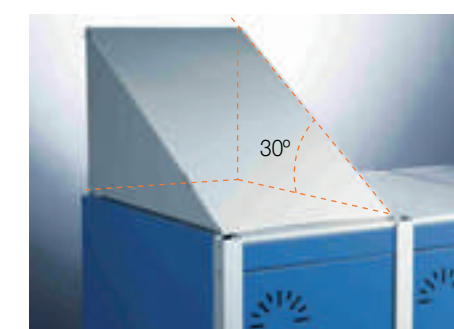

Artículo Item Article	Peso k Weight k Poids k	Ancho Largueur Width	Volúmen Volume Volume	Referencia Reference Référence	€/Unidad €/Unit €/Unité
TI250	1,897	250	0,024	69TI0125	
TI300	2,082	300	0,027	69TI0130	
TI400	2,452	400	0,031	69TI0140	

start and add-on system / système d'initial et extensions

sistema de inicial y extensiones



taquilla / locker / casier

Artículo Item Article	Peso k Weight k Poids k	Ancho Width Largueur	Referencia Reference Référence	€/Unidad €/Unit €/Unité	Cod. EAN EAN Code Code EAN
TQ250I	25,596	280	6902502I		8431206692010
TQ250E	18,934	250	6902502E		8431206692027
TQ300I	27,714	330	6903002I		8431206692119
TQ300E	21,052	300	6903002E		8431206692126
TQ400I	31,950	430	6904002I		8431206692218
TQ400E	25,288	400	6904002E		8431206692225

opciones / options / options

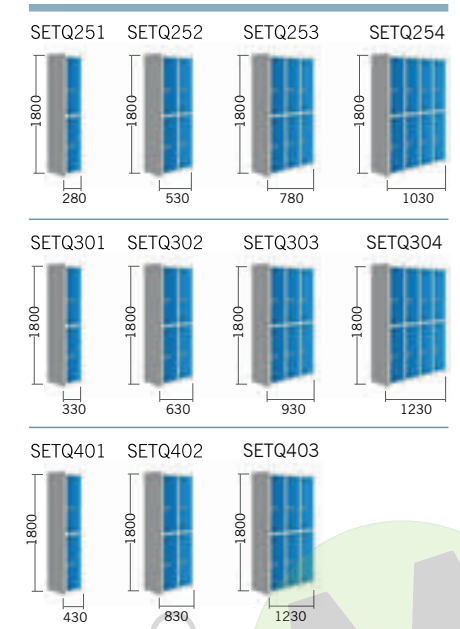
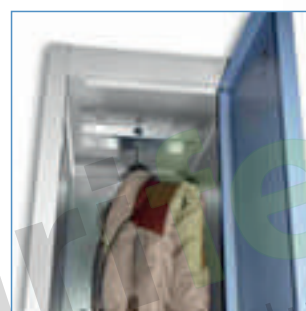

taquilla grupos / group lockers / casier groupes

Artículo Item Article	Peso k Weight k Poids k	Volúmen Volume Volume	Referencia Reference Référence	€/Unidad €/Unit €/Unité	Montaje Assembly Montage	€/Neto €/Net €/Net
TQ251	25,596	0,262	69002512	95,99		
TQ252	44,530	0,496	69002522	176,98		
TQ253	63,464	0,730	69002532	257,97		
TQ254	82,398	0,964	69002542	338,96		
TQ301	27,714	0,309	69003012	103,93		
TQ302	48,766	0,590	69003022	192,86		
TQ303	69,818	0,870	69003032	281,79		
TQ304	90,870	1,151	69003042	370,72		
TQ401	31,950	0,402	69004012	119,81		
TQ402	57,238	0,777	69004022	224,62		
TQ403	82,526	1,151	69004032	329,43		

zócalos / bases / socles

galvanizado / galvanized / galvanisée

Artículo Item Article	Peso k Weight k Poids k	Ancho Width Largueur	Volúmen Volume	Referencia Reference Référence	€/Unidad €/Unit €/Unité
ZC251	2,528	280	-	69ZC0251	
ZC252	3,352	530	-	69ZC0252	
ZC253	4,184	780	-	69ZC0253	
ZC254	5,014	1030	-	69ZC0254	
ZC301	2,692	330	-	69ZC0301	
ZC302	3,682	630	-	69ZC0302	
ZC303	4,678	930	-	69ZC0303	
ZC304	5,674	1230	-	69ZC0304	
ZC401	3,022	430	-	69ZC0401	
ZC402	4,342	830	-	69ZC0402	
ZC403	5,666	1230	-	69ZC0403	



patas / legs / pieds

RAL 7035 gris / grey / gris

Artículo Item Article	Peso k Weight k Poids k	Ancho Width Largueur	Volúmen Volume	Referencia Reference Référence	€/Unidad €/Unit €/Unité
PT251	2,374	220	0,015	69PT0251	
PT252	3,064	470	0,033	69PT0252	
PT253	3,754	720	0,051	69PT0253	
PT254	4,444	970	0,069	69PT0254	
PT301	2,512	270	0,019	69PT0301	
PT302	3,340	570	0,040	69PT0302	
PT303	4,168	870	0,061	69PT0303	
PT304	4,996	1170	0,082	69PT0304	
PT401	2,788	370	0,026	69PT0401	
PT402	3,892	770	0,054	69PT0402	
PT403	4,996	1170	0,082	69PT0403	

start and add-on system / système d'initial et extensions

sistema de inicial y extensiones



consigna / luggage locker / consigne

Artículo Item Article	Peso k Weight k Poids k	Ancho Width Largeur	Referencia Reference Référence	€/Unidad €/Unit €/Unité	Cod. EAN EAN Code Code EAN
CS250I	26,069	280	6902504I		8431206694014
CS250E	19,420	250	6902504E		8431206694021
CS300I	28,289	330	6903004I		8431206694113
CS300E	21,639	300	6903004E		8431206694120
CS400I	32,727	430	6904004I		8431206694212
CS400E	26,078	400	6904004E		8431206694229

opciones / options / options



accesorios / accessories / accessoires

Artículo Item Article	Peso k Weight k Poids k	Referencia Reference Référence	€/Unidad €/Unit €/Unité
Divisor vertical gv. (AR400I - AR400E) Vertical divider gv. (AR400I-AR400E) Séparateur vertical gv. (AR400I-AR400E)	4,591	69090001	
Balda adicional gv. 250 mm (AR) Extra shelf gv. 250 mm (AR) Tablette additionnelle gv 250 mm (AR)	0,916	69090250	
Balda adicional gv. 300 mm (AR) Extra shelf gv. 300 mm (AR) Tablette additionnelle gv 300 mm (AR)	1,058	69090300	
Balda adicional gv. 400 mm (AR) Extra shelf gv. 400 mm (AR) Tablette additionnelle gv. 400 mm (AR)	1,341	69090400	
Embellecedor lateral 1800H (Azul RAL 5014) Side trim 1800 H (Blue 5014 Ral) Enjoliveur latéral 1800H (Blue RAL 5014)	5,945	69001800	



Divisor vertical
Vertical divider
Séparateur vertical



Balda galvanizada
Galvanized shelf
Tablette galvanisée



Embellecedor lateral
Side trim
Enjoliveur latéral

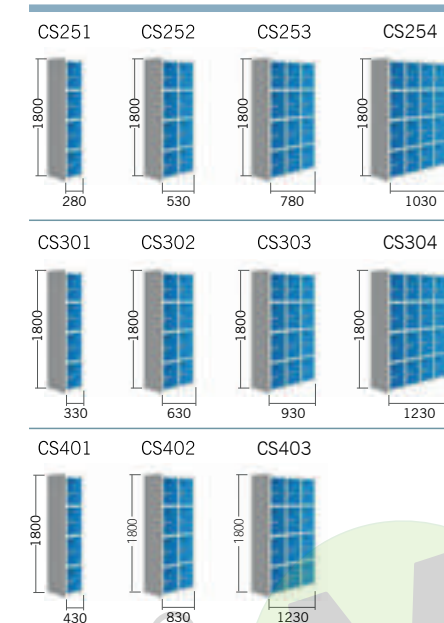

consigna grupos

groups of luggage lockers / consigne groupes

Artículo Item Article	Peso k Weight k Poids k	Volúmen Volume Volume	Referencia Reference Référence	€/Unidad €/Unit €/Unité	Montaje € /Neto Assembly € /Net Montage € /Net
CS251	26,069	0,262	69002514	113,40	
CS252	45,489	0,496	69002524	211,80	
CS253	64,909	0,730	69002534	310,20	
CS254	84,329	0,964	69002544	408,60	
CS301	28,289	0,309	69003014	123,06	
CS302	49,928	0,590	69003024	231,12	
CS303	71,567	0,870	69003034	339,18	
CS304	93,206	1,151	69003044	447,24	
CS401	32,727	0,402	69004014	142,36	
CS402	58,805	0,777	69004024	269,72	
CS403	84,883	1,151	69004034	397,08	

accesorios / accessories / accessoires

Artículo Item Article	Referencia Reference Référence	€/Unidad €/Unit €/Unité
Cerradura de cilindro cromada (Dos llaves) Chrome cylinder lock (two keys) Serrure à cylindre chromé (deux clés)	69000001	
Cerradura aparejada (Parejas de dos) Precio /Unidad Coupled lock (pairs) Price/unit Serrure couplée (par deux) Prix /Unité	69000002	
Cerradura amaestrada Master-key lock Serrure à clé maîtresse	69000003	
Llave maestra / Master key / Passe-partout général	69000004	
Cerradura de candado (candado no incluido) Padlock lock (padlock not included) Serrure à cadenas (cadenas non fourni)	69000008	
Cerradura de monedero / Coin operated-lock / Monnayeur	69000012	
Ranura buzón / Mailbox slot / Rainure boîte aux lettres	69000020	

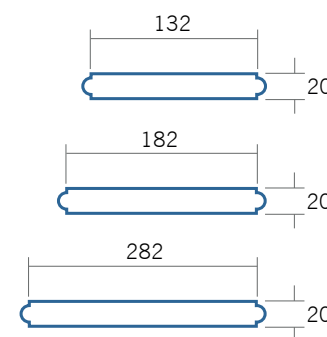

Ranura buzón
Mailbox slot
Rainure pour boîte à lettres



Cerradura de cilindro cromada
Chrome cylinder lock
Serrure à cylindre chromé



Cerradura de candado
Coupled lock
Serrure à cadenas



Cerradura de monedero
Coin operated-lock
Monnayeur

start and add-on system / système d'initial et extensions

sistema de inicial y extensiones



bancos / benches / bancs

Artículo Item Article	Peso k Weight k Poids k	Perchas Hooks Porte-manteaux	Volúmen Volume Volume	Referencia Reference Référence	€/Unidad €/Unit €/Unité	Cod. EAN EAN Code Code EAN
BD100B	8,723	-	0,165	69BD100B		8431206692102
BD150B	13,077	-	0,247	69BD150B		8431206692157
BD200B	15,832	-	0,329	69BD200B		8431206692201
BD100A	15,300	4	0,663	69BD100A		8431206694106
BD150A	21,660	6	0,995	69BD150A		8431206694151
BD200A	25,355	8	1,326	69BD200A		8431206694205
BD100D	31,920	8	1,354	69BD100D		8431206698104
BD150D	46,770	12	2,031	69BD150D		8431206698159
BD200D	56,040	16	2,708	69BD200D		8431206698203

colgadores / hangers / patères

Artículo Item Article	Peso k Weight k Poids k	Perchas Hooks Porte-manteaux	Volúmen Volume Volume	Referencia Reference Référence	€/Unidad €/Unit €/Unité	Cod. EAN EAN Code Code EAN
CD1000	1,035	4	0,010	69CD1004		8431206691105
CD1500	1,700	6	0,015	69CD1506		8431206691150
CD2000	2,270	8	0,020	69CD2008		8431206691204

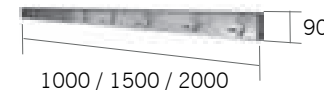

artículo / item / article: BD100A / BD150A / BD200A



artículo / item / article: BD100B / BD150B / BD200B

El buen gusto resalta la vista.
Los listones de pino barnizado en combinación con una estructura de tubo de acero, pintada en un color suave y cálido (gris RAL 7035), consigue que sea un elemento ideal para lograr ambientes agradables.

Good taste at a glance.
The varnished pine slats combined with a steel tube structure, painted in a soft colour (grey RAL 7035) provides an ideal element that enhances and helps to achieve a pleasant environment.

Le bon goût saute aux yeux.
Les lattes de pin vernis combinées à la structure en tube d'acier, peinte en couleur tendre et chaude (gris RAL 7035) en font un élément idéal pour créer des ambiances agréables.



artículo / item / article: BD100D / BD150D / BD200D



unassembled benches / bancs démontées
bancos desmontados

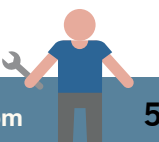

armario ropero / wardrobe / armoire garde-robe

Artículo Item Article	Peso k Weight k Poids k	Volúmen Volume Volume	Referencia Reference Référence	€/Unidad €/Unit €/Unité	Cod. EAN EAN Code Code EAN
AR251-ES	16,522	0,225	68002511ES		8431206681212
AR252-ES	31,907	0,450	68002521ES		8431206681229
AR253-ES	47,292	0,675	68002531ES		8431206681236
AR254-ES	62,677	0,900	68002541ES		8431206681243
AR301-ES	17,363	0,270	68003011ES		8431206681311
AR302-ES	33,589	0,540	68003021ES		8431206681328
AR303-ES	49,815	0,810	68003031ES		8431206681335
AR304-ES	66,041	1,080	68003041ES		8431206681342
AR401-ES	19,445	0,360	68004011ES		8431206681410
AR402-ES	37,753	0,720	68004021ES		8431206681427
AR403-ES	56,061	1,080	68004031ES		8431206681434

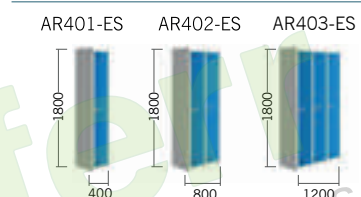
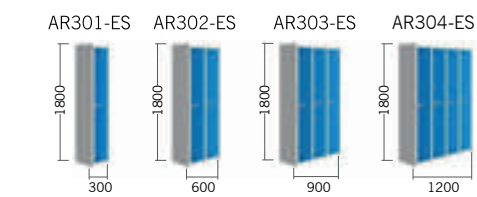
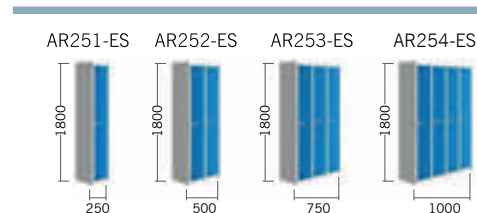

consigna / luggage lockers / consigne

Artículo Item Article	Peso k Weight k Poids k	Volúmen Volume Volume	Referencia Reference Référence	€/Unidad €/Unit €/Unité	Cod. EAN EAN Code Code EAN
CL251-ES	17,606	0,225	68002513ES		8431206683216
CL252-ES	34,075	0,450	68002523ES		8431206683223
CL253-ES	50,544	0,675	68002533ES		8431206683230
CL254-ES	67,013	0,900	68002543ES		8431206683247
CL301-ES	18,998	0,270	68003013ES		8431206683315
CL302-ES	36,859	0,540	68003023ES		8431206683322
CL303-ES	54,720	0,810	68003033ES		8431206683339
CL304-ES	72,581	1,080	68003043ES		8431206683346
CL401-ES	21,223	0,360	68004013ES		8431206683414
CL402-ES	41,309	0,720	68004023ES		8431206683421
CL403-ES	61,395	1,080	68004033ES		8431206683438

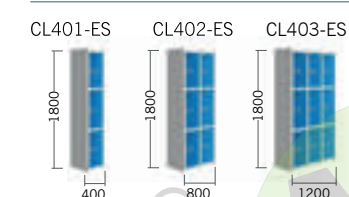
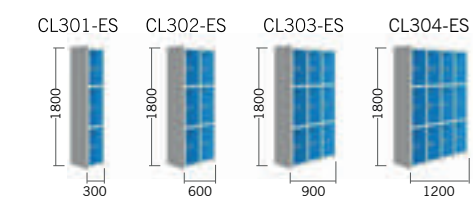
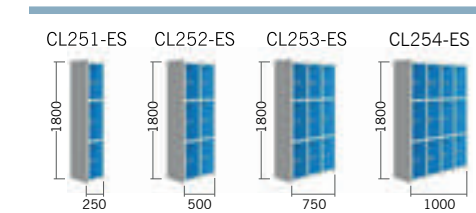

taquilla / locker / casier

Artículo Item Article	Peso k Weight k Poids k	Volúmen Volume Volume	Referencia Reference Référence	€/Unidad €/Unit €/Unité	Cod. EAN EAN Code Code EAN
TQ251-ES	16,896	0,225	68002512ES		8431206682219
TQ252-ES	32,281	0,450	68002522ES		8431206682226
TQ253-ES	47,666	0,675	68002532ES		8431206682233
TQ254-ES	63,051	0,900	68002542ES		8431206682240
TQ301-ES	17,737	0,270	68003012ES		8431206682318
TQ302-ES	33,963	0,540	68003022ES		8431206682325
TQ303-ES	50,189	0,810	68003032ES		8431206682332
TQ304-ES	66,415	1,080	68003042ES		8431206682349
TQ401-ES	19,819	0,360	68004012ES		8431206682417
TQ402-ES	38,127	0,720	68004022ES		8431206682424
TQ403-ES	56,435	1,080	68004032ES		8431206682431

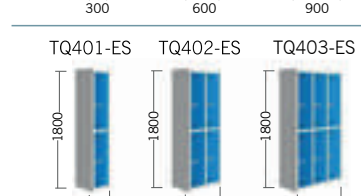
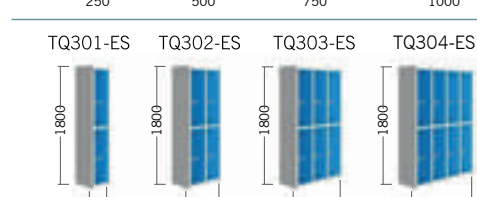
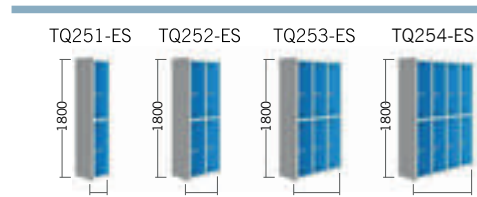

consigna / luggage lockers / consigne

Artículo Item Article	Peso k Weight k Poids k	Volúmen Volume Volume	Referencia Reference Référence	€/Unidad €/Unit €/Unité	Cod. EAN EAN Code Code EAN
CS251-ES	18,299	0,225	68002514ES		8431206684213
CS252-ES	35,461	0,450	68002524ES		8431206684220
CS253-ES	52,623	0,675	68002534ES		8431206684237
CS254-ES	69,785	0,900	68002544ES		8431206684244
CS301-ES	19,420	0,270	68003014ES		8431206684312
CS302-ES	37,703	0,540	68003024ES		8431206684329
CS303-ES	55,986	0,810	68003034ES		8431206684336
CS304-ES	74,269	1,080	68003044ES		8431206684343
CS401-ES	22,194	0,360	68004014ES		8431206684411
CS402-ES	43,521	0,720	68004024ES		8431206684428
CS403-ES	64,848	1,080	68004034ES		8431206684435

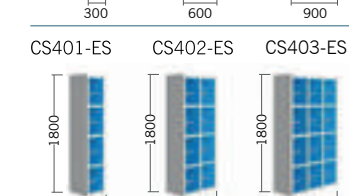
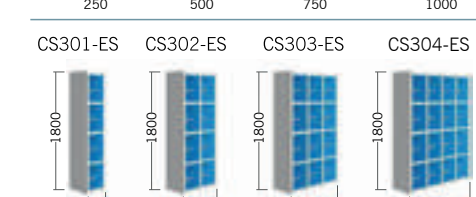
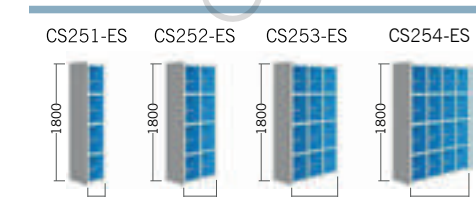

opciones / options / options



welded structure / structure soudée
estructura soldada

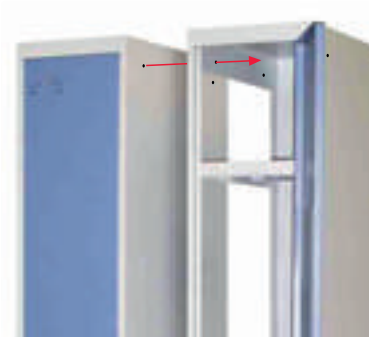

armario de limpieza / cleaning locker / armoire entretien

Artículo Item Article	Peso k Weight k Poids k	Volúmen Volume Volume	Referencia Reference Référence	€/Unidad €/Unit €/Unité	Cod. EAN EAN Code Code EAN
LP1800	24,800	0,360	68001800LP		8431206680031

Incluidas baldas / Shelves included / Tablettes inclus



artículo / item / article: SKI500

artículo / item / article: SKI350



armario de documentos

document cupboard / armoire à documents

Artículo Item Article	Peso k Weight k Poids k	Volúmen Volume Volume	Referencia Reference Référence	€/Unidad €/Unit €/Unité	Cod. EAN EAN Code Code EAN
DC0900	32,500	0,340	68000900DC		8431206680116
DC2000	61,500	0,756	68002000DC		8431206680154

Artículo: DC0900 (incluye dos baldas) – DC2000 (incluye cuatro baldas)
Item DC0900 (includes two shelves) – DC2000 (includes four shelves)
Article DC0900 (comprend deux tablettes) – DC2000 (comprend quatre tablettes)



Tubo colgador
Hanger tube
Tube porteur



Cerradura de falleba
Espagnolette lock
Serrure à fléaus



Ventilación inferior
Bottom ventilation
Ventilation inférieure



armario ski / ski cupboard / armoire garde-ski

Artículo Item Article	Peso k Weight k Poids k	Volúmen Volume Volume	Referencia Reference Référence	€/Unidad €/Unit €/Unité	Cod. EAN EAN Code Code EAN
SKI350	27,379	0,368	6800350SKI		8431206680215
SKI500	31,712	0,525	6800500SKI		8431206680222

Cerradura de falleba con dos puntos de cierre
Two-point espagnolette lock / Serrure à fléau deux points

armario de limpieza / cleaning locker / armoire d'entretien

Artículo Item Article	Peso k Weight k Poids k	Volúmen Volume Volume	Referencia Reference Référence	€/Unidad €/Unit €/Unité	Cod. EAN EAN Code Code EAN
SV1800LP	26,931	0,045	69SV1800LP		8431206018018



artículo / item / article: SV1800LP



artículo / item / article: SV1800OR



Serie Venecia

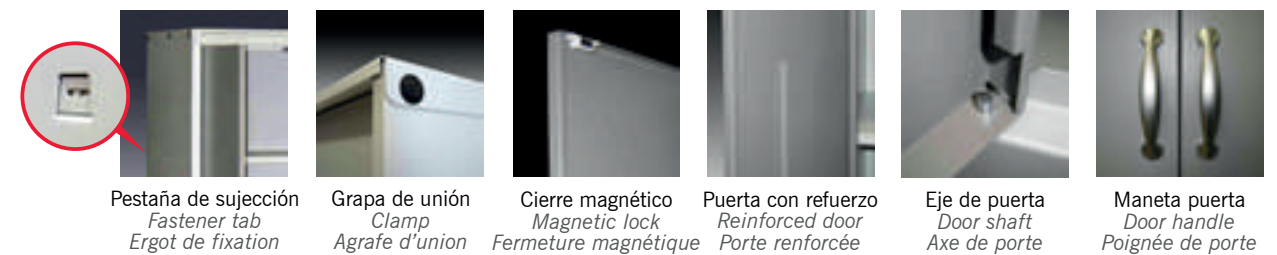

armario de ordenación
tidy storage locker / armoire de rangement

Artículo Item Article	Peso k Weight k Poids k	Volúmen Volume Volume	Referencia Reference Référence	€/Unidad €/Unit €/Unité	Cod. EAN EAN Code Code EAN
SV0900OR	23,207	0,036	69SV0900OR		8431206009023
SV1800OR	44,917	0,072	69SV1800OR		8431206018025

unassembled lockers / armoires démontées
armarios desmontados

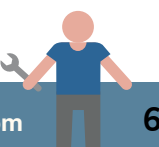

Desarrollamos sus ideas

We develop your ideas / Nous développons vos idées



J600 sistema de encastre

socket system / système d'encastrement

- 1 Perfil / Upright / Profilé
- 2 Fondo "L" / L cross beam / Traverse L
- 3 Larguero "C" / "C" beam / Longeron C
- 4 Travesaño de refuerzo / Deck support / Traverse de renfort
- 5 Aglomerado / Chipboard / Aggloméré
- 6 Balda galvanizada / Galvanised shelf / Tablette galvanisée
- 7 Unión perfil / Upright attachment / Union Profilé
- 8 Base sencilla 40 / Single foot / Base simple*

(* Consultar página 8 / Consult page 8 / Consulter page 8)

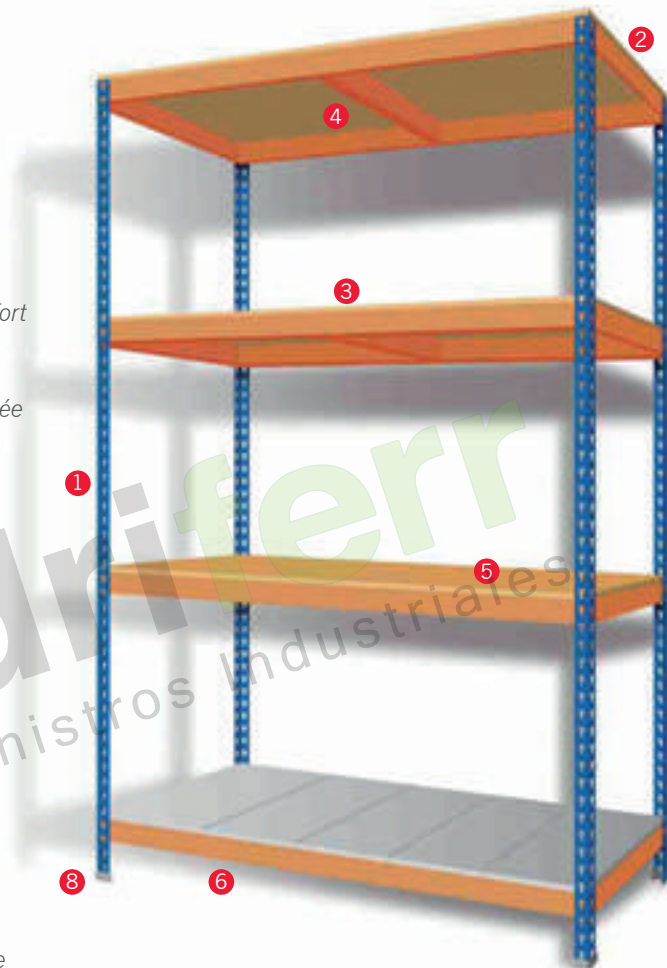
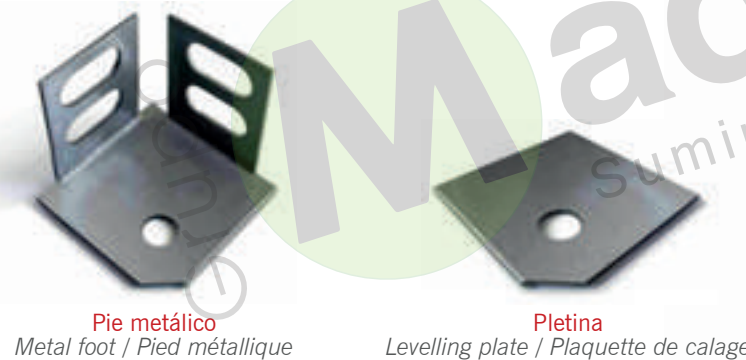

perfiles / uprights / profilés

RAL 5010 azul / blue / bleu

Artículo L Item L Article L	Peso k Weight k Poids k	Uds. Paquete Units Package Unités Paquet	Referencia Reference Référence	€/Unidad €/Unit €/Unité	Cod. EAN EAN Code Code EAN
J/40 de 2000	1,832	10	75034020		8431206754206
J/40 de 2500	2,273	10	75034025		8431206754251
J/40 de 3000	2,748	10	75034030		8431206754305

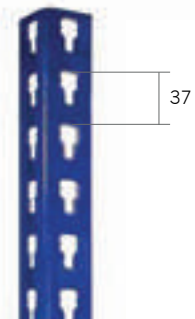

accesorios / accessories / accessoires

Artículo L Item L Article L	Peso k Weight k Poids k	Uds. Paquete Units Package Unités Paquet	Referencia Reference Référence	€/Unidad €/Unit €/Unité	Cod. EAN EAN Code Code EAN
Pletina 1,5 mm. 1.5 mm L. plate P. de calage 1,5 mm.	0,017	1	75000008		8431206750086
Pie Metálico Metal foot Pied métallique	0,063	4	75000031		8431206750314
Retenedor Retainer Reteneur	0,036	2	75000032		8431206750321
Unión Perfil Upright attachment Union Profilé	0,093	4	75000033		8431206750338



fondos "L" / L cross beams / traverses L

RAL 2004 naranja / orange

Artículo L Item L Article L	Peso k Weight k Poids k	Uds. Paquete Units Package Unités Paquet	Referencia Reference Référence	€/Unidad €/Unit €/Unité	Cod. EAN EAN Code Code EAN
L0300/L	0,356	10	75041030		8431206751038
L0450/L	0,541	10	75041045		8431206751045
L0600/L	0,726	10	75041060		8431206751069
L0750/L	0,912	10	75041075		8431206751083
L0900/L	1,097	10	75041090		8431206751090
L1000/L	1,221	10	75041100		8431206751106

largueros "C" / "C" beams / longerons C

RAL 2004 naranja / orange

Artículo L Item L Article L	Peso k Weight k Poids k	Uds. Paquete Units Package Unités Paquet	Referencia Reference Référence	€/Unidad €/Unit €/Unité	Cod. EAN EAN Code Code EAN
L0900/C	1,359	10	75042090		8431206752097
L1200/C	1,818	10	75042120		8431206752127
L1500/C	2,277	10	75042150		8431206752158
L1800/C	2,736	10	75042180		8431206752189
L2100/C*	3,195	10	75042210		8431206752219
L2400/C*	3,654	10	75042240		8431206752240

(* Consultar disponibilidad / Consult availability / Consulter stock)

travesaños de refuerzo

deck supports / traverses de renfort

RAL 2004 naranja / orange

Artículo L Item L Article L	Peso k Weight k Poids k	Uds. Paquete Units Package Unités Paquet	Referencia Reference Référence	€/Unidad €/Unit €/Unité	Cod. EAN EAN Code Code EAN
L0450	0,632	10	75043045		8431206753049
L0600	0,818	10	75043060		8431206753063
L0750	1,005	10	75043075		8431206753087
L0900	1,191	10	75043090		8431206753094
L1000	1,316	10	75043100		8431206753100

baldas / shelves / tablettes

galvanizado / galvanised / galvanisée

Artículo LxP Item LxD Article LxP	Peso k Weight k Poids k	Uds. Paquete Units Package Unités Paquet	Referencia Reference Référence	€/Unidad €/Unit €/Unité	Cod. EAN EAN Code Code EAN
300 x 300	0,754	10	75094030		8431206754039
450 x 300	1,041	10	75094045		8431206754046
600 x 300	1,329	10	75094060		8431206754060
750 x 300	1,617	10	75094075		8431206754084
900 x 300	1,904	10	75094090		8431206754091
1000 x 300	2,096	10	75094100		8431206754107

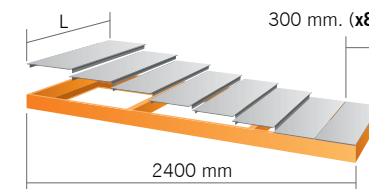
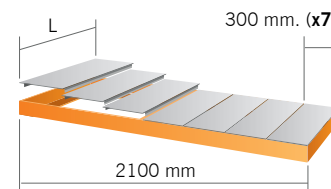
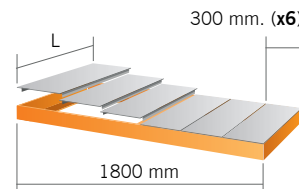
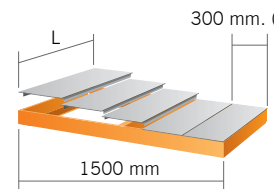
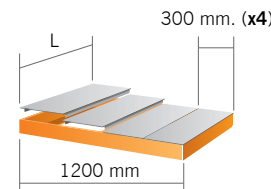
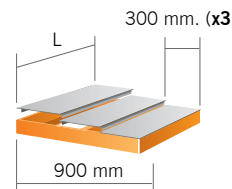

aglomerado 1 pieza / chipboard 1 item / aggloméré 1 pièce

Artículo LxP Item LxD Article LxP	Peso k Weight k Poids k	Uds. Paquete Units Package Unités Paquet	Referencia Reference Référence	€/Unidad €/Unit €/Unité	Cod. EAN EAN Code Code EAN
900 x 300	2,786	1	75090030		8431206750932
900 x 450	4,208	1	75090045		8431206750949
900 x 600	5,629	1	75090060		8431206750963
900 x 750	7,050	1	75090075		8431206750970
900 x 900	8,472	1	75090090		8431206750994
900 x 1000	9,420	1	75090100		8431206750901
1200 x 300	3,721	1	75120030		8431206751236
1200 x 450	5,619	1	75120045		8431206751243
1200 x 600	7,518	1	75120060		8431206751267
1200 x 750	9,416	1	75120075		8431206751274
1200 x 900	11,315	1	75120090		8431206751298
1200 x 1000	12,580	1	75120100		8431206751205

Espesor / Thickness / Epaisseur
16 mm

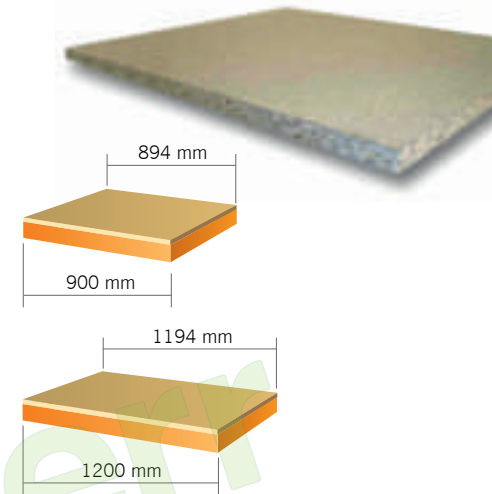

aglomerado 2 piezas / chipboard 2 items / aggloméré 2 pièces

Artículo LxP Item LxD Article LxP	Peso k Weight k Poids k	Uds. Paquete Units Package Unités Paquet	Referencia Reference Référence	€/Unidad €/Unit €/Unité	Cod. EAN EAN Code Code EAN
1500 x 300	4,656	1	75150030		8431206751533
1500 x 450	7,031	1	75150045		8431206751540
1500 x 600	9,407	1	75150060		8431206751564
1500 x 750	11,782	1	75150075		8431206751571
1500 x 900	14,158	1	75150090		8431206751595
1500 x 1000	15,741	1	75150100		8431206751502
1800 x 300	5,591	1	75180030		8431206751830
1800 x 450	8,443	1	75180045		8431206751847
1800 x 600	11,296	1	75180060		8431206751861
1800 x 750	14,148	1	75180075		8431206751878
1800 x 900	17,001	1	75180090		8431206751892
1800 x 1000	18,902	1	75180100		8431206751809
2100 x 300	6,526	1	75210030		8431206752134
2100 x 450	9,855	1	75210045		8431206752141
2100 x 600	13,185	1	75210060		8431206752165
2100 x 750	16,514	1	75210075		8431206752172
2100 x 900	19,844	1	75210090		8431206752196
2100 x 1000	22,063	1	75210100		8431206752103
2400 x 300	7,461	1	75240030		8431206752431
2400 x 450	11,267	1	75240045		8431206752448
2400 x 600	15,074	1	75240060		8431206752462
2400 x 750	18,880	1	75240075		8431206752479
2400 x 900	22,687	1	75240090		8431206752493
2400 x 1000	25,224	1	75240100		8431206752400

Espesor / Thickness / Epaisseur
16 mm

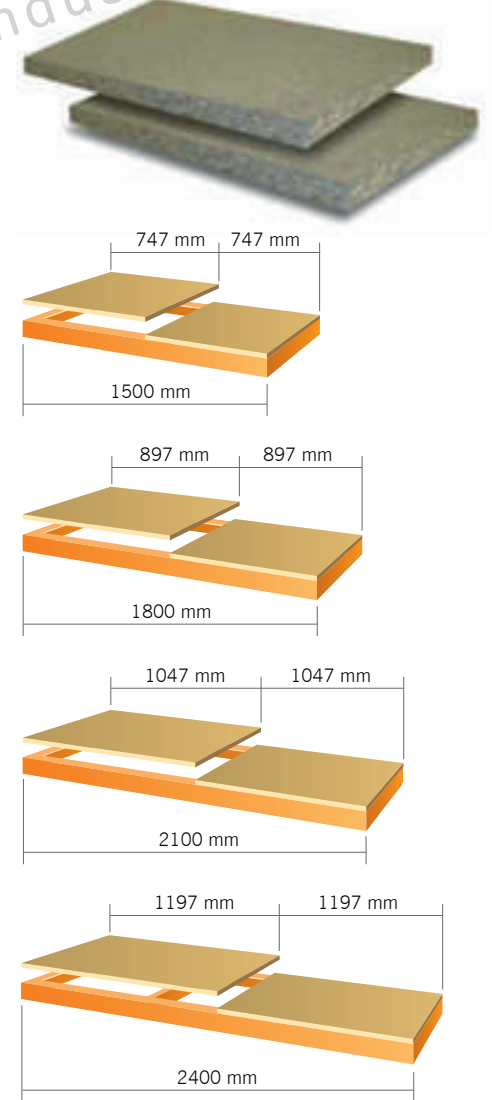



1200.450.3 / 1200.600.3

Artículo Item Article	Peso k Weight k Poids k	Uds. paquete Units Package Unités Paquet	Referencia Reference Référence	€/Unidad €/Unit €/Unité	Cod. EAN EAN Code Code EAN
	1200.450.3 1200.600.3	4 2000 mm	unidades units/unités		
	6 450 / 600 mm				
	6 1200 mm				
	3 450 / 600 mm				
	3 1194 x 444 mm 1194 x 594 mm				

J600 3 niveles / J600 3 levels / J600 3 niveaux

Artículo Item Article	Peso k Weight k Poids k	Uds. paquete Units Package Unités Paquet	Referencia Reference Référence	€/Unidad €/Unit €/Unité	Cod. EAN EAN Code Code EAN
J600/1200.450.3	23,378	1	75031243		8431206752431
J600/1200.600.3	25,046	1	75031263		8431206752639

aglomerado / chipboard / aggloméré

Artículo Item Article	Peso k Weight k Poids k	Uds. envase Units Pack Unités Emballage	Referencia Reference Référence	€/Envase €/Pack €/Emballage	Cod. EAN EAN Code Code EAN
1194 x 444	15,270	3	75120453		8431206124535
1194 x 594	20,424	3	75120603		8431206126034

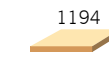

1500.450.3 / 1500.600.3

Artículo Item Article	Peso k Weight k Poids k	Uds. paquete Units Package Unités Paquet	Referencia Reference Référence	€/Unidad €/Unit €/Unité	Cod. EAN EAN Code Code EAN
	1500.450.3 1500.600.3	4 2000 mm	unidades units/unités		
	6 450 / 600 mm				
	6 1500 mm				
	3 450 / 600 mm				
	6 747 x 444 mm 747 x 594 mm				

J600 3 niveles / J600 3 levels / J600 3 niveaux

Artículo Item Article	Peso k Weight k Poids k	Uds. paquete Units Package Unités Paquet	Referencia Reference Référence	€/Unidad €/Unit €/Unité	Cod. EAN EAN Code Code EAN
J600/1500.450.3	26,132	1	75031543		8431206755432
J600/1500.600.3	27,800	1	75031563		8431206755630

aglomerado / chipboard / aggloméré

Artículo Item Article	Peso k Weight k Poids k	Uds. envase Units Pack Unités Emballage	Referencia Reference Référence	€/Envase €/Pack €/Emballage	Cod. EAN EAN Code Code EAN
747 x 444	19,104	6	75075453		8431206154532
747 x 594	25,560	6	75075603		8431206156031

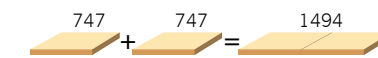

1800.450.3 / 1800.600.3

Artículo Item Article	Peso k Weight k Poids k	Uds. paquete Units Package Unités Paquet	Referencia Reference Référence	€/Unidad €/Unit €/Unité	Cod. EAN EAN Code Code EAN
	1800.450.3 1800.600.3	4 2000 mm	unidades units/unités		
	6 450 / 600 mm				
	6 1800 mm				
	3 450 / 600 mm				
	6 897 x 444 mm 897 x 594 mm				

J600 3 niveles / J600 3 levels / J600 3 niveaux

Artículo Item Article	Peso k Weight k Poids k	Uds. paquete Units Package Unités Paquet	Referencia Reference Référence	€/Unidad €/Unit €/Unité	Cod. EAN EAN Code Code EAN
J600/1800.450.3	28,886	1	75031843		8431206758433
J600/1800.600.3	30,554	1	75031863		8431206758631

aglomerado / chipboard / aggloméré

Artículo Item Article	Peso k Weight k Poids k	Uds. envase Units Pack Unités Emballage	Referencia Reference Référence	€/Envase €/Pack €/Emballage	Cod. EAN EAN Code Code EAN
897 x 444	22,938	6	75090453		8431206184539
897 x 594	30,690	6	75090603		8431206186038

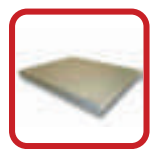
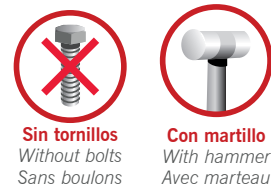
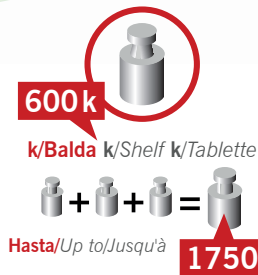

Instrucciones de montaje / Assembly instructions / Instructions de montage





1200.450.4 / 1200.600.4



1500.450.4 / 1500.600.4



1800.450.4 / 1800.600.4

1200.450.4 1200.600.4	unidades units/unités
	4 2000 mm
	8 450 / 600 mm
	8 1200 mm
	4 450 / 600 mm
	4 1194 x 444 mm 1194 x 594 mm

1500.450.4 1500.600.4	unidades units/unités
	4 2000 mm
	8 450 / 600 mm
	8 1500 mm
	4 450 / 600 mm
	8 747 x 444 mm 747 x 594 mm

1800.450.4 1800.600.4	unidades units/unités
	4 2000 mm
	8 450 / 600 mm
	8 1800 mm
	4 450 / 600 mm
	8 897 x 444 mm 897 x 594 mm

J600 4 niveles / J600 4 levels / J600 4 niveaux

Artículo Item Article	Peso k Weight k Poids k	Uds. paquete Units Package Unités Paquet	Referencia Reference Référence	€/Unidad €/Unit €/Unité	Cod. EAN EAN Code Code EAN
J600/1200.450.4	28,728	1	75031244		8431206752448
J600/1200.600.4	30,952	1	75031264		8431206752646

aglomerado / chipboard / aglomerado

Artículo Item Article	Peso k Weight k Poids k	Uds. envase Units Pack Unités Emballage	Referencia Reference Référence	€/Envase €/Pack €/Emballage	Cod. EAN EAN Code Code EAN
1194 x 444	20,360	4	75120454		8431206124542
1194 x 594	27,232	4	75120604		8431206126041



J600 4 niveles / J600 4 levels / J600 4 niveaux

Artículo Item Article	Peso k Weight k Poids k	Uds. paquete Units Package Unités Paquet	Referencia Reference Référence	€/Unidad €/Unit €/Unité	Cod. EAN EAN Code Code EAN
J600/1500.450.4	32,400	1	75031544		8431206755449
J600/1500.600.4	34,624	1	75031564		8431206755647

aglomerado / chipboard / aglomerado

Artículo Item Article	Peso k Weight k Poids k	Uds. envase Units Pack Unités Emballage	Referencia Reference Référence	€/Envase €/Pack €/Emballage	Cod. EAN EAN Code Code EAN
747 x 444	25,472	8	75075454		8431206154549
747 x 594	34,080	8	75075604		8431206156048



J600 4 niveles / J600 4 levels / J600 4 niveaux

Artículo Item Article	Peso k Weight k Poids k	Uds. paquete Units Package Unités Paquet	Referencia Reference Référence	€/Unidad €/Unit €/Unité	Cod. EAN EAN Code Code EAN
J600/1800.450.4	36,072	1	75031844		8431206758440
J600/1800.600.4	38,296	1	75031864		8431206758648

aglomerado / chipboard / aglomerado

Artículo Item Article	Peso k Weight k Poids k	Uds. envase Units Pack Unités Emballage	Referencia Reference Référence	€/Envase €/Pack €/Emballage	Cod. EAN EAN Code Code EAN
897 x 444	30,584	8	75090454		8431206184546
897 x 594	40,920	8	75090604		8431206186045

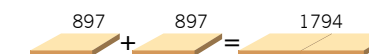

600k
k/Balda k/Shelf k/Tablette
Hasta/Up to/Jusqu'à **1750**

Sin tornillos
Without bolts
Sans boulons

Con martillo
With hammer
Avec marteau

RAL 2004 naranja
Orange

RAL 5010 Azul
Blue/Bleu

24
Unidades Palet
Units Pallet / Unités Palet

24
Unidades Aglomerado
Units Chipboard / Unités Aggloméré

Instrucciones de montaje / Assembly instructions / Instructions de montage

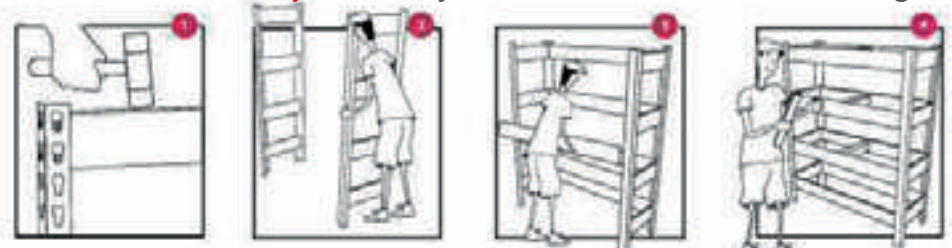

bancos de trabajo / work benches / bancs de travail

Artículo Item Article	Peso k Weight k Poids k	Uds. paquete Units Package Unités Paquet	Referencia Reference Référence	€/Unidad €/Unit €/Unité	Cod. EAN EAN Code Code EAN
BTS/900	23,870	1	75030091		8431206750093
BTS/1200	28,764	1	75030121		8431206750123
BTS/1500	35,098	1	75030151		8431206750154



RAL 5010 Azul
Blue/Bleu



RAL 2004 Naranja
Orange



BTS/900	unidades units/unités
	4 900 mm
	4 600 mm
	4 900 mm
	2 600 mm
	2 894 x 594 mm



Instrucciones de montaje
Assembly instructions
Instructions de montage

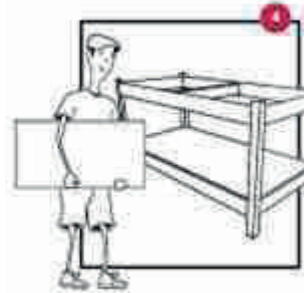
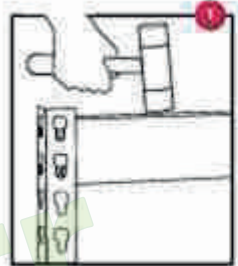

BTS/1200	unidades units/unités
	4 900 mm
	4 600 mm
	4 1200 mm
	2 600 mm
	2 1194 x 594 mm



BTS/1500	unidades units/unités
	4 900 mm
	4 600 mm
	4 1500 mm
	2 600 mm
	2 1494 x 594 mm

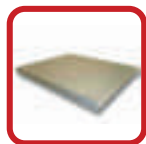
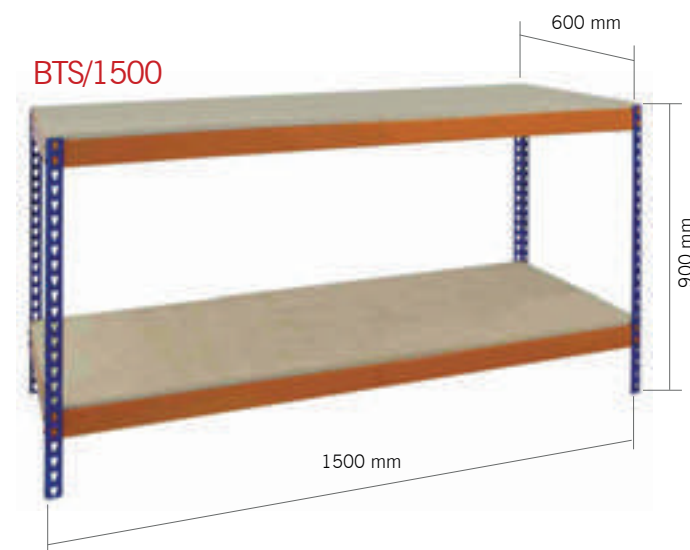

Aglomerado incluido
Chipboard included / Aggloméré inclus



Unidades Palet
Units Pallet / Unités Palet

26

Hasta/Up to/Jusqu'à



600k
k/Balda k/Shelf k/Tablette



Sin tornillos
Without bolts
Sans boulons



Con martillo
With hammer
Avec marteau



bancos de trabajo / work benches / bancs de travail

Artículo Item Article	Peso k Weight k Poids k	Uds. paquete Units Package Unités Paquet	Referencia Reference Référence	€/Unidad €/Unit €/Unité	Cod. EAN EAN Code Code EAN
BTE/900	42,018	1	75030093		8431206750291
BTE/1200	52,292	1	75030123		8431206750321
BTE/1500	62,566	1	75030153		8431206750352



BTE/900	unidades units/unités
	2 600 mm 2 900 mm 2 1500 mm
	4 300 mm 4 750 mm
	8 900 mm
	2 750 mm
	2 894 x 294 mm 2 894 x 744 mm



BTE/1200	unidades units/unités
	2 600 mm 2 900 mm 2 1500 mm
	4 300 mm 4 750 mm
	8 1200 mm
	2 750 mm
	2 1194 x 294 mm 2 1194 x 744 mm



BTE/1500	unidades units/unités
	2 600 mm 2 900 mm 2 1500 mm
	4 300 mm 4 750 mm
	8 1500 mm
	2 750 mm
	2 1494 x 294 mm 2 1494 x 744 mm

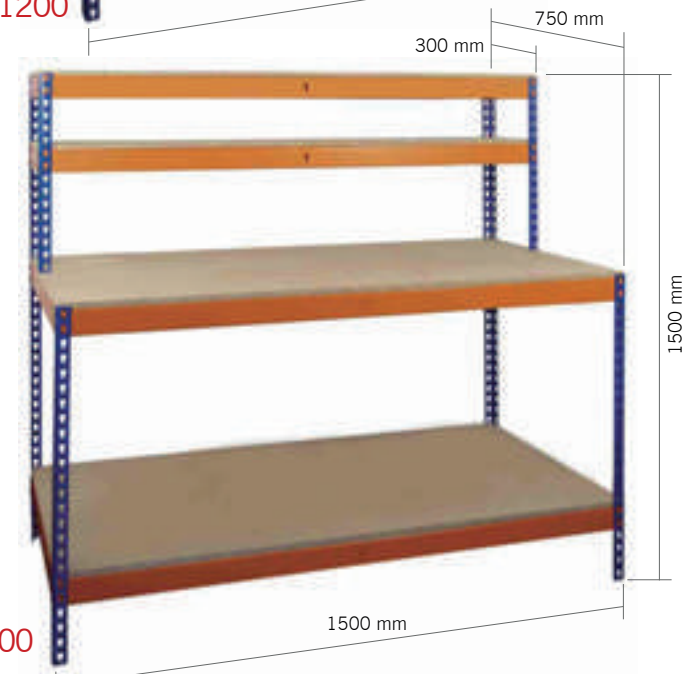

Instrucciones de montaje
Assembly instructions
Instructions de montage

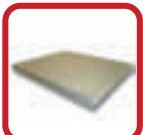
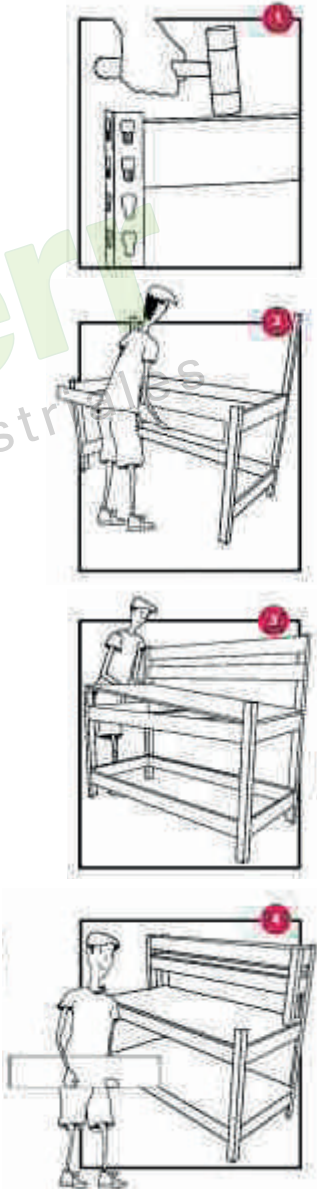

Aglomerado incluido
Chipboard included / Aggloméré inclus



Unidades Palet
Units Pallet / Unités Palet



Hasta/Up to/Jusqu'à
600k
k/Balda k/Shelf k/Tablette



Sin tornillos
Without bolts
Sans boulons



Con martillo
With hammer
Avec marteau

bancos de trabajo / work benches / bancs de travail

Artículo Item Article	Peso k Weight k Poids k	Uds. paquete Units Package Unités Paquet	Referencia Reference Référence	€/Unidad €/Unit €/Unité	Cod. EAN EAN Code Code EAN
BTP/900	30,974	1	75030092		8431206750192
BTP/1200	38,542	1	75030122		8431206750222
BTP/1500	46,112	1	75030152		8431206750253

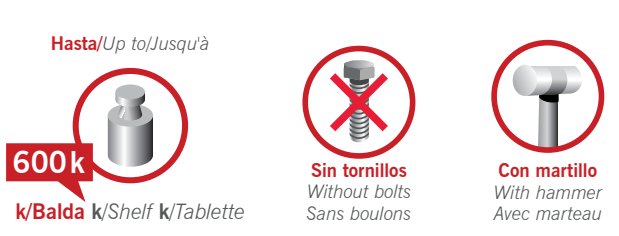

BTP/900

unidades units/unités
2 900 mm
2 1500 mm
4 600 mm
4 900 mm
2 600 mm
2 894 x 594 mm
2 900 x 300 mm
10

BTP/1200

unidades units/unités
2 900 mm
2 1500 mm
4 600 mm
4 1200 mm
2 600 mm
2 1194 x 594 mm
2 1200 x 300 mm
10

BTP/1500

unidades units/unités
2 900 mm
2 1500 mm
4 600 mm
4 1500 mm
2 600 mm
2 1494 x 594 mm
2 1500 x 300 mm
10

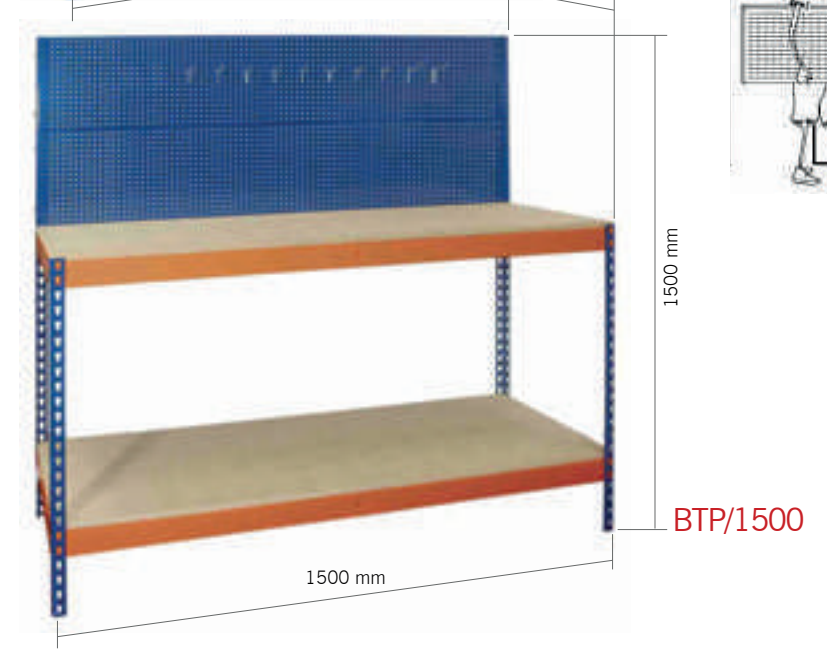

Instrucciones de montaje
Assembly instructions
Instructions de montage

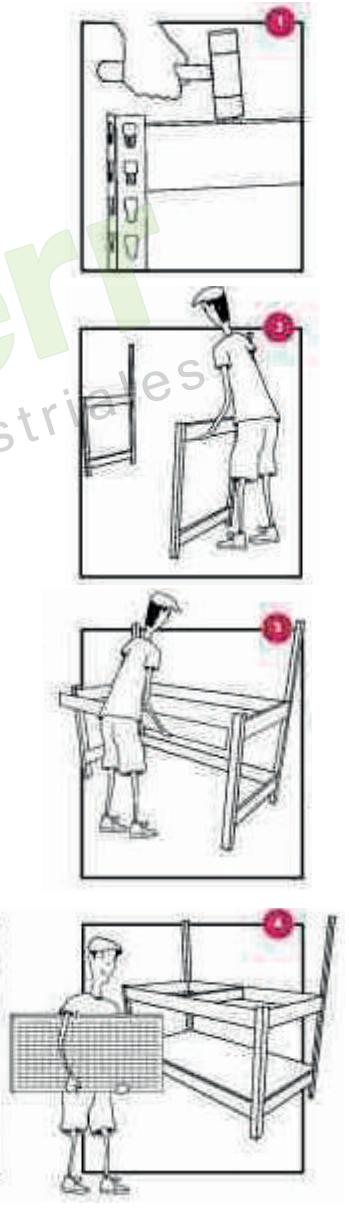

paletización convencional

conventional palletization / palettisation conventionnelle

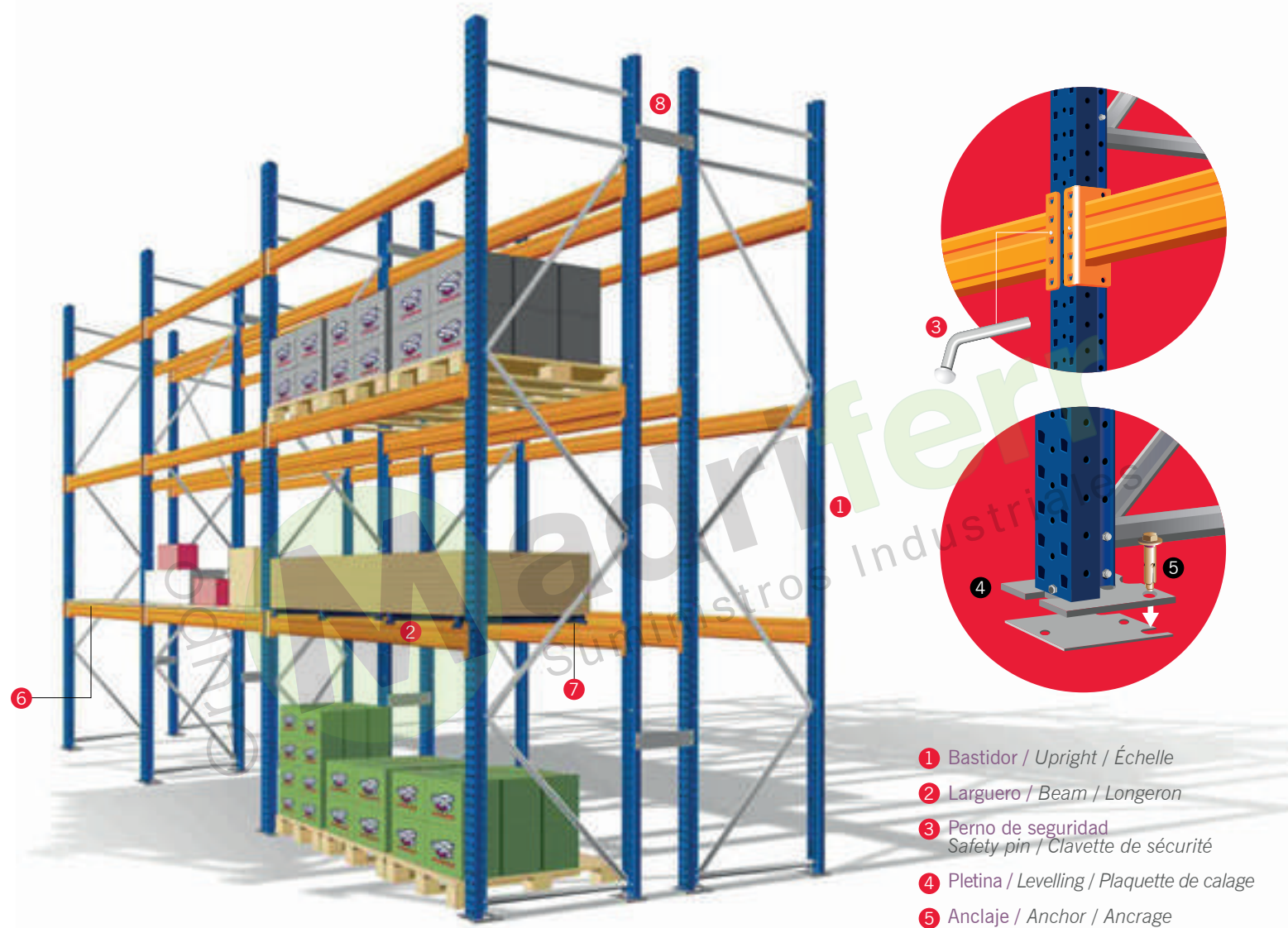

- 1 Bastidor / Upright / Échelle
- 2 Larguero / Beam / Longeron
- 3 Perno de seguridad / Safety pin / Clavette de sécurité
- 4 Pletina / Levelling / Plaquette de calage
- 5 Anclaje / Anchor / Ancrage
- 6 Travesaño exterior aglomerado / External chipboard cross member / Traverse extérieure agglomérée
- 7 Travesaño elevado / Raised cross member / Traverse élevée
- 8 Unión bifrontal / Bi-frontal attachment / Union bifrontale

Paletización convencional, la respuesta apropiada al almacenaje de productos paletizados con un gran número de referencias, permitiendo, con su configuración estructural, un acceso directo a cada paleta sin necesidad de desplazar o mover otras.

Conventional palletization, the ideal solution for storing palletized goods with a large number of references. The structural layout allows direct access to each pallet without having to move others.

La palettisation conventionnelle, la réponse adaptée au stockage de produits palettisés comprenant un grand nombre de références, permettant, grâce à sa configuration structurelle, l'accès direct à chaque palette sans avoir à en déplacer d'autres.



paletización convencional

conventional palletization / palettisation conventionnelle



RAL 2004 naranja / orange

larguero CC2 / CC2 beam / longeron CC2

Artículo L Item L/Article L	Peso k Weight k/Poids k	Referencia Reference/Référence	€/Unidad €/Unit/€/Unité
CC2 80 / 1825	9,675	77010029	
CC2 100 / 1825	10,439	77010104	
CC2 80 / 2225	11,341	77010030	
CC2 100 / 2225	12,389	77010105	
CC2 80 / 2700	13,342	77010031	
CC2 100 / 2700	14,704	77010106	
CC2 120 / 2700	15,976	77010256	
CC2 140 / 2700	17,247	77010331	
CC2 150 / 2700	17,883	77010406	
CC2 150 / 3300	21,515	77010407	

bastidor D80.20 / D80.20 upright / échelle D80.20

Artículo HxP Item HxD/Article HxP	Peso k Weight k/Poids k	Referencia Reference/Référence	€/Unidad €/Unit/€/Unité
2000 x 1050	24,540	77021121	
2500 x 1050	29,850	77021122	
3000 x 1050	35,071	77021124	
3500 x 1050	40,381	77021126	
4000 x 1050	44,552	77021127	
4500 x 1050	49,861	77021129	
5000 x 1050	55,171	77021131	
5500 x 1050	60,481	77021132	
6000 x 1050	65,702	77021134	

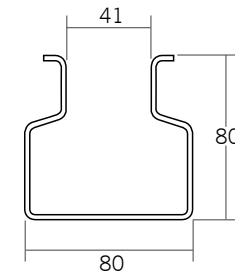

RAL 5010 azul / blue / bleu

bastidor D100.20 / D100.20 upright / échelle D100.20

Artículo HxP Item HxD/Article HxP	Peso k Weight k/Poids k	Referencia Reference/Référence	€/Unidad €/Unit/€/Unité
4000 x 1050	49,324	77021055	
4500 x 1050	55,231	77021057	
5000 x 1050	61,137	77021059	
5500 x 1050	67,043	77021060	
6000 x 1050	72,861	77021062	

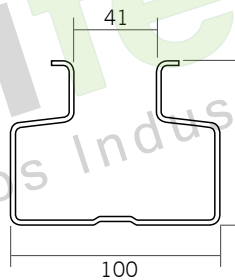

nuevo
new/nouveau

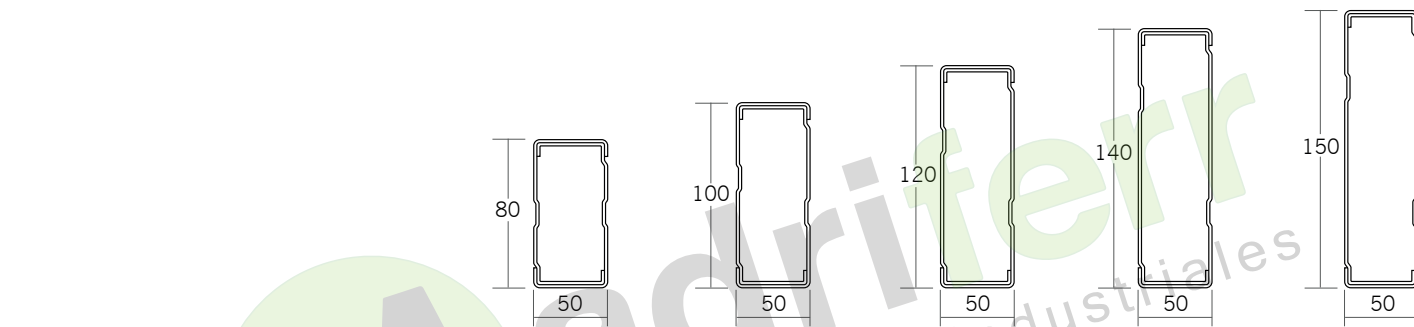

Larguero Beam Longueron	L / 950	L / 1150	L / 1350	L / 1825	L / 2225	L / 2700	L / 3300
CC2 80	4300 k	3700 k	3300 k	2600 k	2200 k	1600 k	-
CC2 100	-	-	4100 k	3200 k	2700 k	2300 k	-
CC2 120	-	-	-	-	-	2800 k	2400 k
CC2 140	-	-	-	-	-	3200 k	2700 k
CC2 150	-	-	-	-	-	3400 k	3000 k

Capacidad de carga por par de largueros
Load capacity per pair of beams / Capacité de charge par couple de longérons

Nº de paletas No. of pallets Nº de palettes	Paleta Palet / Palette (A) 800 x 1200	Paleta Palet / Palette (A) 1000 x 1200	Paleta Palet / Palette (A) 1200 x 1200
1	(L) 950	(L) 1150	(L) 1350
2	(L) 1825	(L) 2225	(L) 2700
3	(L) 2700	(L) 3300	-

(L) Longitud larguero / (L) Length of beam / (L) Longueur du longeron

Bastidores en fondo 700 y 850, consultar
Uprights with 700 and 850 depth, please consult / Echelles de fond 700 et 850, consulter

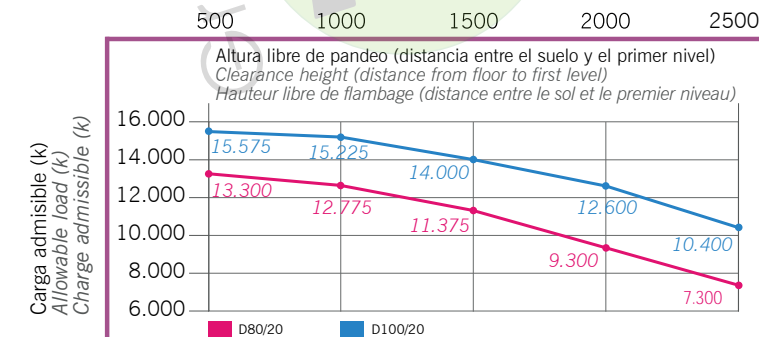

1. Tornillo M10 x 20 DIN-933.8.8 / Bolt / Boulon
2. Tornillo M10 x 60 DIN-933.8.8 / Bolt / Boulon
3. Tuerca M10 DIN-985.8 / Nut / Écrou
4. Distanciador Ø 16/13 L= 38 mm / Separator / Séparateur
5. Distanciador Ø 16/13 L= 28 mm / Separator / Séparateur
6. Tuerca M10 DIN-934.8 / Nut / Écrou
7. Pie metálico / Footplate / Pied métallique
8. Puntal de bastidor / Upright profile / Montant du échelle
9. Diagonal vertical / Vertical diagonal / Diagonale verticale
10. Diagonal horizontal / Horizontal diagonal / Diagonale horizontale

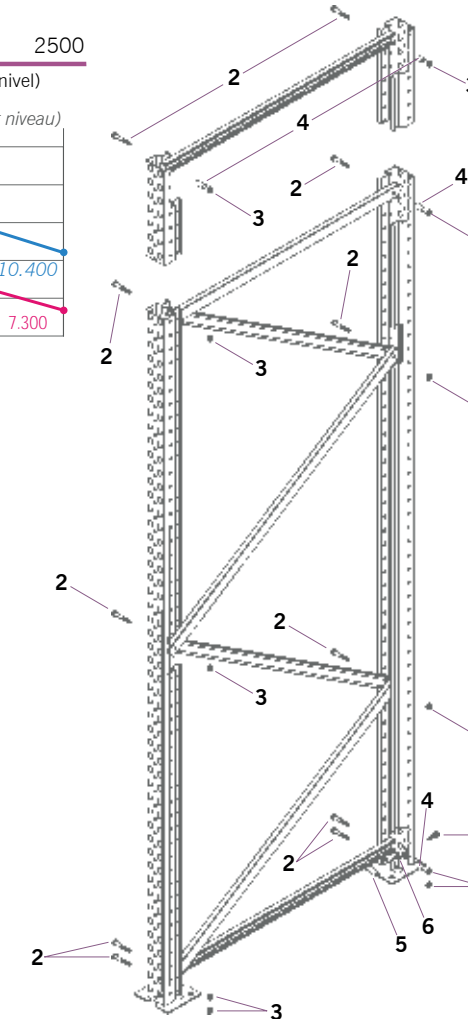
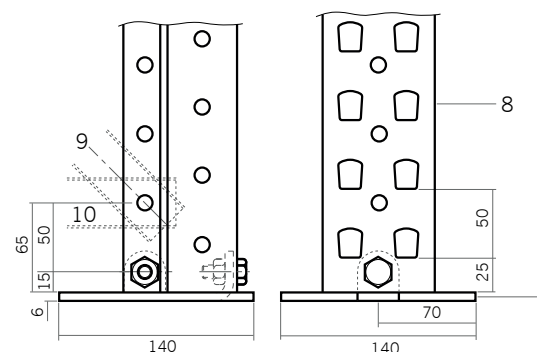

Instrucciones de montaje / assembly instructions / instructions de montage

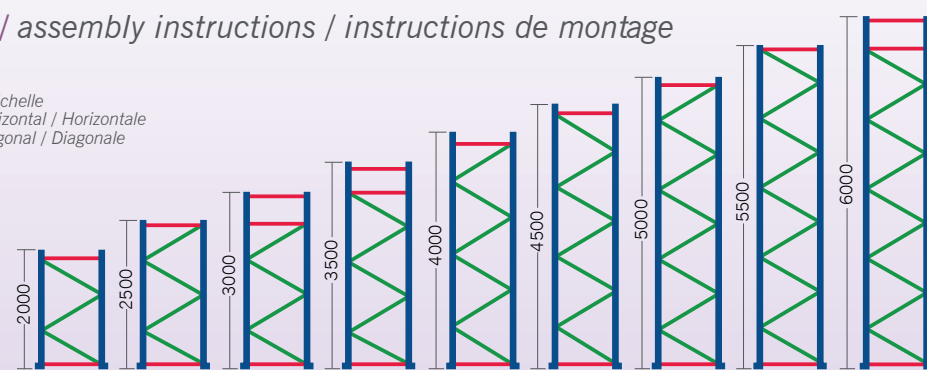

paletización convencional

conventional palletization / palettisation conventionnelle

galvanizado / galvanized / galvanisée

Artículo Item Article	Peso k Weight k Poids k	Referencia Reference Référence	€/Unidad €/Unit €/Unité
Perno de seguridad / Larguero Safety pin / Beam Clavette de sécurité / Longeron	0,011	77000001	
Pletina de nivelación 1,5 mm Levelling plate 1,5 mm Plaquette de calage 1,5 mm	0,218	77000008	
M10 x 70 anclaje / Suelo M10 x 70 Anchor / Floor Ancrage M10 x 70 / Sol	0,080	77000034	

galvanizado / galvanized / galvanisée

Artículo Item Article	Peso k Weight k Poids k	Referencia Reference Référence	€/Unidad €/Unit €/Unité
Unión a pared 100 mm Attachment to wall 100 mm Union au mur 100 mm	0,214	77000037	3,59
Unión a pared 200 mm Attachment to wall 200 mm Union au mur 200 mm	0,356	77000038	3,86
Unión a pared 300 mm Attachment to wall 300 mm Union au mur 300 mm	0,490	77000039	4,14
Unión bifrontal 300 mm Bi-frontal attachment 300 mm Union bifrontale 300 mm	0,490	77000048	4,14

Tornillería incluida / Bolts included / Boulons fournis



Unión a pared
Attachment to wall / Union au mur

Unión bifrontal
Bi-frontal attachment / Union bifrontale

Artículo Item Article	Peso k Weight k Poids k	Referencia Reference Référence	€/Unidad €/Unit €/Unité
Travesaño exterior aglomerado 1050 mm External chipboard cross member 1050 mm Traverse extérieure agglomérée 1050 mm	3,213	77000053	
Travesaño interior paleta 1050 mm Internal pallet cross member 1050 mm Traverse intérieure palette 1050 mm	4,120	77000056	

referencia / reference / référence: 77000053
galvanizado / galvanized / galvanisée



referencia / reference / référence: 77000056
RAL 5010 azul / blue / bleu

RAL 5010 azul / blue / bleu

Artículo Item Article	Peso k Weight k Poids k	Referencia Reference Référence	€/Unidad €/Unit €/Unité
Travesaño elevado 1050 mm Raised cross member 1050 mm Traverse élevée 1050 mm	4,680	77000059	



nuevo
new/nouveau

RAL 1003 amarillo / yellow / jaune

Artículo Item Article	Peso k Weight k Poids k	Referencia Reference Référence	€/Unidad €/Unit €/Unité
Protección bastidor Upright protection Protection échelle	8,385	77000030	
Protección lateral 1150 mm Side protection 1150 mm Protection latérale 1150 mm	6,178	77000032	
Protección lateral 2500 mm Side protection 2500 mm Protection latérale 2500 mm	19,478	77000033	
Anclaje M16 x 110 / Protector M16 x 110 anchor / Protector Ancrage M16 x 110 / Protecteur	0,279	77000035	



Tornillería incluida. Anclajes no incluidos / Screws included. Anchors not included / Visserie inclus. Ancrages non inclus



cantil sigma

cantil sigma / cantil sigma



(U) Unión / Bracing / Contrevents
 800-1000-1200-1400-1600-1800-2000-2200

Brazo / Arm / Bras
 500-600-700-800-1000-1200-1500-1800-2000-2200

7 Columna h/ H column / Colonne h
 2000-2400-3000-3400-4000-4400-5000-5400-6000-6400-7000-7400-8000





1 Brazo 86h
86h arm / Bras 86h

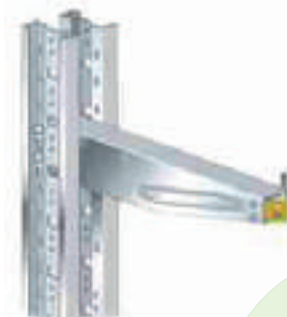

2 Brazo 180h
180h arm / Bras 180h



3 Base de columna
Column base / Base de colonne



5 Retenedor
Retainer / Reteneur

4 Protector del brazo
Arm protector / Protection du bras

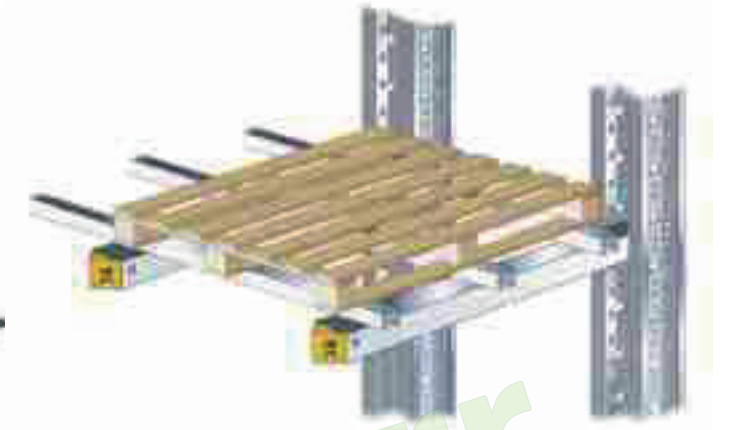
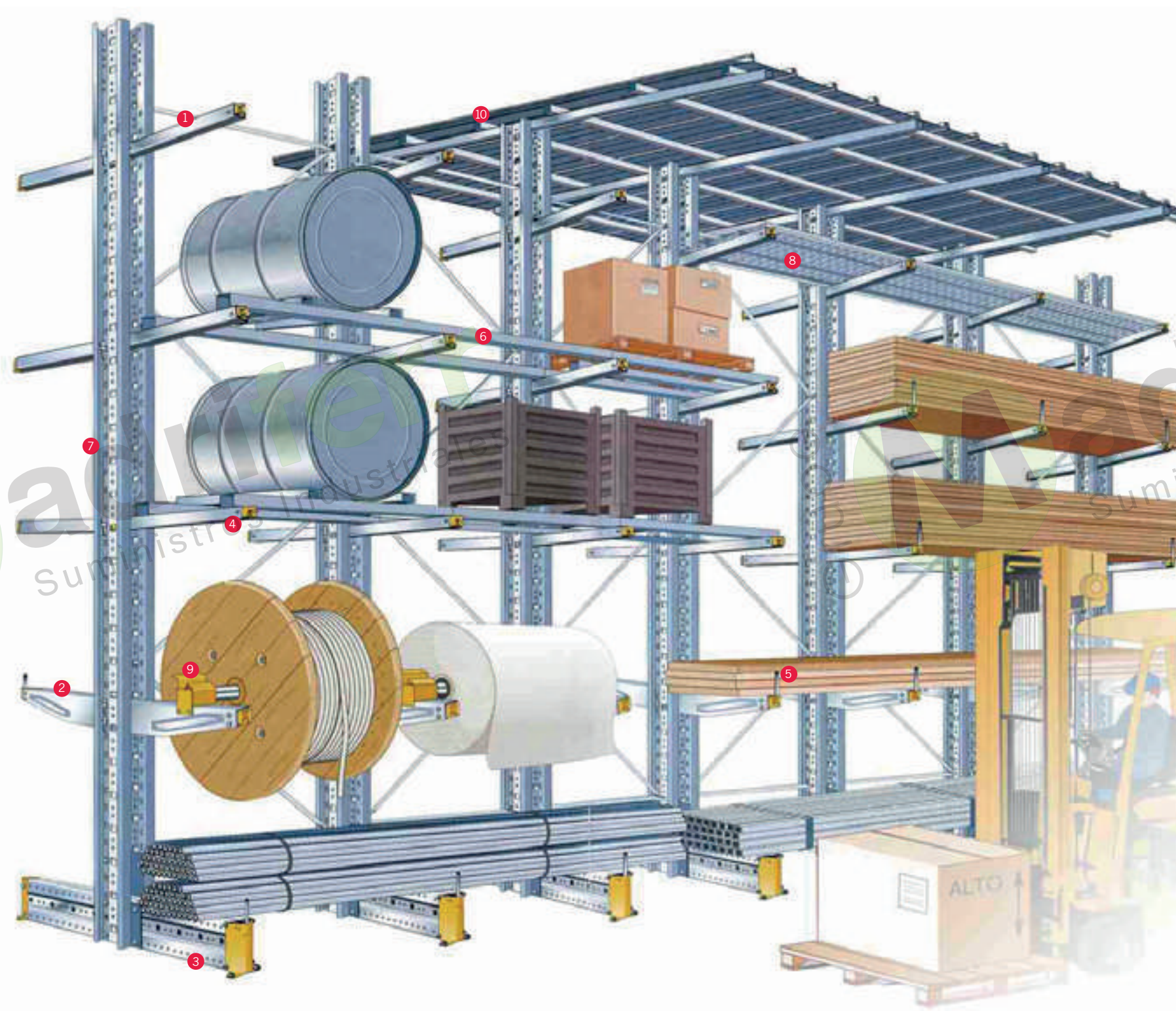

6 Travesaño / Cross member / Traverse

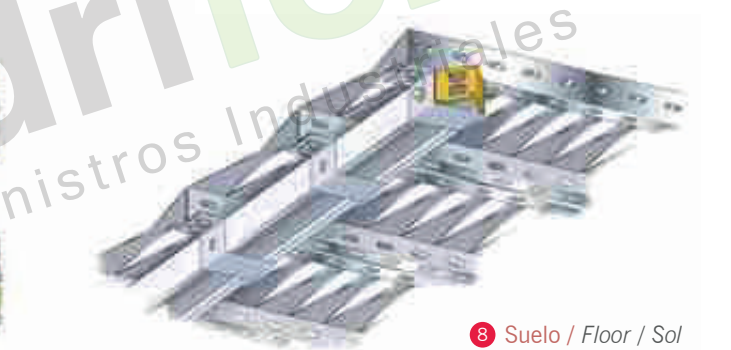

8 Suelo / Floor / Sol

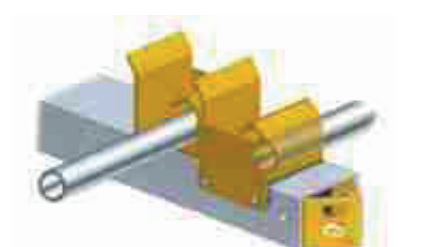

9 Portabobinas / Reel holder / Porte bobines



10 Techo / Ceiling / Plafond

Cantil Sigma, la forma más apropiada de almacenar mercancías de grandes dimensiones: perfilera, tubos, maderas o productos de medidas irregulares.

Cantil Sigma, the best way to store large goods: sections, pipes, wood or irregularly sized products.

Cantil Sigma, le meilleur moyen de stocker les marchandises de grandes dimensions: profilés, tubes, bois de construction ou autres produits aux mesures irrégulières.

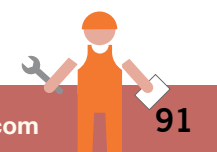

Grupo



Suministros Industriales

91 870 70 60

pedidos@madriferr.com

atencionalcliente@madriferr.com

www.madriferr.com

Punto de Venta Arganda y Oficinas Centrales
Avda. Finanzauto, 15
28500 – Arganda del Rey (Madrid)

Punto de Venta M40 – La Fortuna
C/ Elvas, 5
28917 – Leganés (Madrid)