

MICEL[®]

soluciones en herrajes





MICEL[®]

soluciones en herrajes

www.micel.es



DESCRIPCIÓN DEL PRODUCTO

	Código	8431488	Medida	Acabado					€uros
	00000	00000	mm	-	-	-	-	-	XXXX
Caja	11111	111111	mm	-	-	-	-	-	XXXX
Blister	22222	222222	mm	-	-	-	-	-	XXXX

















































































8431488 = EAN13 del producto
 Código = Código de referencia del producto

PRESENTACIÓN DEL PRODUCTO

	Productos etiquetados con código de barras individual			Unidades contenidas en envase (cantidad mínima de venta)	Embalaje
Caja	Presentación en caja de cartón			Unidades contenidas en envase (cantidad mínima de venta)	Embalaje
Rollo	Presentación en rollo			Unidades contenidas en envase (cantidad mínima de venta)	Embalaje
Blister	Presentación en blister para autoventa		Unidades incluidas en el blister	No es necesario adquirir el embalaje completo	Embalaje



NOMENCLATURA DEL PRODUCTO

Color	Abreviatura	Muestra	Color	Abreviatura	Muestra
ABEDUL	AB		MORADO	MR	
ALUMINIO	AL		NARANJA	NA	
AMARILLO	AM		NEGRO	NE	
ANTRACITA	AT		NEGRO PORO	NEP	
AZUL	AZ		NEGRO SATINADO	NN	
BEIGE	BE		NÍQUEL	NI	
BICROMATADO	BC		NÍQUEL MATE	NM	
BIORO	BI		NÍQUEL SATINADO	NS	
BLANCO	BL		NOGAL	NO	
BLANCO PORO	BP		NUEZ	UN	
BLANCO/PINTAS	BLP		OLMO CLARO	OLC	
BRONCE	BR		OLMO OSCURO	OLO	
CAOBA	CA		ORO	OR	
CENIZA	CZ		ORO MATE	OM	
CEREZO	CE		PAVONADO	PV	
CEREZO CLARO	CEC		PINO	PI	
COBREADO	CBR		PINO CLARO	PIC	
CREMA	CRM		PINTABLE	PTB	
CROMADO	CR		PINTADO	PNT	
CROMO BRILLO	CB		PLATA	PL	
CROMO MATE	CM		PLATA ENVEJECIDA	PE	
CROMO/NÍQUEL	CN		PVD	PVD	
CUERO	CU		RAL9006	RAL9006	
EFEECTO INOX	EI		ROBLE	RB	
FRESNO	FR		ROBLE BLANCO	RBB	
GALVANIZADO	GV		ROBLE CLARO	RBC	
GRIS	GR		ROBLE OSCURO	RBO	
GRIS BEIGE	GRB		ROJO	RO	
GRIS MARENGO	GRM		SAPELI	SA	
HAYA	HY		SICOROMO	SC	
HIERRO PULIDO	PU		SURTIDO	SURTIDO	
INOX	IN		TEXTIL BEIGE	TXB	
LATÓN	LT		TEXTIL CLARO	TXC	
LATÓN ENVEJECIDO	LE		TEXTIL OSCURO	TXO	
LATÓN PULIDO	LP		TRANSPARENTE	TR	
LATÓN SATINADO	LS		VERDE	VE	
LATONADO	LTD		WENGUE	WE	
MAPLE	MP		WENGUE CENIZA	WEC	
MARFIL	MF		ZAMAK NATURAL	ZKN	
MARRÓN	MA		ZINCADO	ZN	



COMPRA ONLINE

Como cliente registrado en el portal, tendrás la posibilidad de realizar compras online o un presupuesto, acceder al catálogo y precios, descargar fichas, imágenes y croquis de los productos, conocer las novedades y las ofertas, acceder y actualizar tus datos de usuario, consultar el estado de tus pedidos de compra, visualizar y descargar facturas y albaranes, y estar informado con nuestra newsletter.

MANILLAS

PÁG. 7

Manillas - Rosetas - Manillones - Placas - Bocallaves - Mulefillas - Tiradores - Pomos interior - Cremonas



ALUMINIO

PÁG. 53

Manillas - Cierres de presión - Pomos - Asas - Cierres de corredera - Bisagras - Cremonas - Pasadores - Golpetes - Bocallaves - Cerraderos - Manillones - Rodamientos - Mosquiteras



COMPLEMENTOS PUERTA

PÁG. 91

Llamadores - Pomos - Manillones - Ojo de buey - Mirillas - Clavos - Placas - Escudos - Cilindros - Cerrojos - Cuadradillos - Tornillos - Cuñas y garras - Buletes - Tapajuntas - Topes - Retenedores - Aldabas - Cierres - Pasadores - Dedales - Pasamanos - Números y letras - Puertas correderas



CABINA SANITARIA Y HERRAJE MAMPARA

PÁG. 151

Mulefillas - Pomos - Soportes - Bisagras - Patas - Pinzas - Escuadras - Tubos - Perfiles - Perchas - Tornillos - Cerraduras cristal - Perfiles mampara



PICAPORTES, PERNIOS Y BISAGRAS

PÁG. 167

Picaportes - Kit puerta corredera - Cerraduras picoloro - Cierrapuertas - Pernios - Bisagras



POMOS Y TIRADORES

PÁG. 197

Tiradores - Pomos - Asas - Tornillos tirador



GUÍAS Y SOPORTES TV

PÁG. 211

Bisagra elevable - Guías - Soportes teclado - Pasacables - Soportes TV



COMPLEMENTOS ARMARIO Y MUEBLE

PÁG. 223

Interiorismo armario - Tubo armario y accesorios - Leds - Cerraduras - Bocallaves - Puertas correderas armario - Expulsores - Golpetes - Cierres - Neodimios - Ferritas - Tapones - Lágrimas - Canto - Portaestantes - Excéntricas - Tuercas - Ensamblés - Deslizantes - Filtros - Cierres de caja - Tornillería



ÁNGULOS, PALOMILLAS Y SOPORTES

PÁG. 295

Embellecedores - Soportes - Cremalleras - Esquineros - Palomillas - Ángulos - Placas - Escuadras - Estructuras madera



COLGADORES

PÁG. 321

Colgadores - Placas - Anillas - Ganchos - Hembrillas c/tuerca - Perchas



COMPLEMENTOS COCINA

PÁG. 339

Escurreplatos - Cuberteros - Rejillas - Marcos y soportes microondas - Copetes - Zócalos - Protectores y accesorios - Rejillas ventilación - Extracción humos



PATAS, NIVELADORES Y RUEDAS

PÁG. 357

Patas - Niveladores - Conteras - Ruedas



COMPASES

PÁG. 381

Bisagra canapé - Pistones - Compases



HERRAJES DE PERSIANA

PÁG. 387

Recogedores - Tornos - Guías - Soportes - Rodamientos - Cintas - Topes - Lamas - Poleas - Seguros



FERRETERÍA

PÁG. 397

Seguridad infantil - Candados - Guardallaves - Guardaparking - Cadena decorativa - Llave contador - Tendederos - Poleas - Llaveros - Rejilla vegetal - Chinchetas - Tachuelas - Cascabeles - Papel magnético



SOLUCIONES BRIMIC

PÁG. 417

Soluciones pensadas a la medida de tu punto de venta





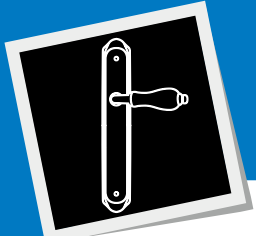

JGO MANILLA L RECTA 565



	Código	8431488	Medida	Acabado			€uros
Caja	05654	056548	225x42 mm	INOX	-	1	20
	05655	056555	225x42 mm	PVD	-	1	20
	05656	056562	225x42 mm	NE	-	1	20
	05657	056579	225x42 mm	BL	-	1	20
Blister	17252	172521	225x42 mm	INOX	1	-	8
	17253	172538	225x42 mm	PVD	1	-	8
	17254	172545	225x42 mm	NE	1	-	8
	17255	172552	225x42 mm	BL	1	-	8

Ángulo recto

Acero Inoxidable

- INOX
- PVD
- NEGRO
- BLANCO

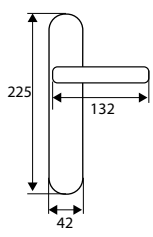

JGO ROSETA L RECTA 565



	Código	8431488	Medida	Acabado			€uros
Caja	00565	005652	132x53 mm	INOX	-	1	20
	05651	056517	132x53 mm	PVD	-	1	20
	05652	056524	132x53 mm	NE	-	1	20
	05653	056531	132x53 mm	BL	-	1	20
Blister	17002	170022	132x53 mm	INOX	1	-	8
	17256	172569	132x53 mm	PVD	1	-	8
	17257	172576	132x53 mm	NE	1	-	8
	17258	172583	132x53 mm	BL	1	-	8

Ángulo recto

Acero Inoxidable

- INOX
- PVD
- NEGRO
- BLANCO

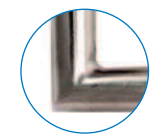
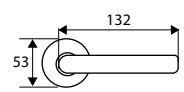

MANILLÓN ROSETA L RECTO 565



	Código	8431488	Medida	Acabado			€uros
Caja	56516	565163	200x19 mm	INOX	-	1	50

Acero Inoxidable

- INOX

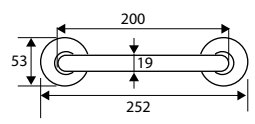

JGO MANILLA L CURVA 575

	Código	8431488	Medida	Acabado				€uros
Caja	05754	057545	225x42 mm	INOX	-	1	20	
	05755	057552	225x42 mm	PVD	-	1	20	
	05756	057569	225x42 mm	NE	-	1	20	
	05757	057576	225x42 mm	BL	-	1	20	
Blister	17237	172378	225x42 mm	INOX	1	-	8	
	17238	172385	225x42 mm	PVD	1	-	8	
	17239	172392	225x42 mm	NE	1	-	8	
	17240	172408	225x42 mm	BL	1	-	8	

Acero Inoxidable



Ángulo curvo

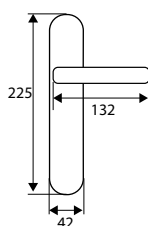

JGO ROSETA L CURVA 575

	Código	8431488	Medida	Acabado				€uros
Caja	00575	005751	132x53 mm	INOX	-	1	20	
	05751	057514	132x53 mm	PVD	-	1	20	
	05752	057521	132x53 mm	NE	-	1	20	
	05753	057538	132x53 mm	BL	-	1	20	
Blister	17003	170039	132x53 mm	INOX	1	-	8	
	17241	172415	132x53 mm	PVD	1	-	8	
	17242	172422	132x53 mm	NE	1	-	8	
	17243	172439	132x53 mm	BL	1	-	8	

Acero Inoxidable



Ángulo curvo

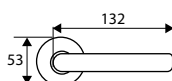

MANILLÓN ROSETA L CURVA 575

	Código	8431488	Medida A	Acabado				€uros
Caja	28150	281506	150x19 mm	INOX	-	1	50	
	28200	282008	200x19 mm	INOX	-	1	50	
	28201	282015	200x19 mm	PVD	-	2	50	
	28202	282022	200x19 mm	NE	-	2	50	
	28203	282039	200x19 mm	BL	-	2	50	
	28250	282503	250x19 mm	INOX	-	1	50	
	28300	283005	300x19 mm	INOX	-	1	50	
	28400	284002	400x19 mm	INOX	-	1	50	
	28500	285009	500x19 mm	INOX	-	1	50	

Acero Inoxidable

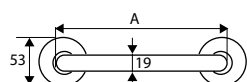

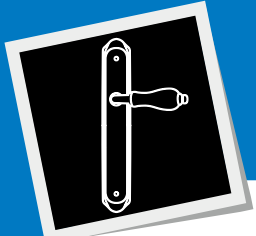

JGO MANILLA U 585



	Código	843 I 488	Medida	Acabado			€uros
Caja	05854	058542	225x42 mm	INOX	-	1	20
	05855	058559	225x42 mm	PVD	-	1	20
	05856	058566	225x42 mm	NE	-	1	20
	05857	058573	225x42 mm	BL	-	1	20
Blister	17259	172590	225x42 mm	INOX	1	-	8
	17260	172606	225x42 mm	PVD	1	-	8
	17261	172613	225x42 mm	NE	1	-	8
	17262	172620	225x42 mm	BL	1	-	8

Ángulo curvo

Acero Inoxidable

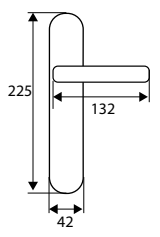

JGO ROSETA U 585



	Código	843 I 488	Medida	Acabado			€uros
Caja	00585	005850	142x53 mm	INOX	-	1	20
	05851	058511	142x53 mm	PVD	-	1	20
	05852	058528	142x53 mm	NE	-	1	20
	05853	058535	142x53 mm	BL	-	1	20
Blister	17004	170046	142x53 mm	INOX	1	-	8
	17263	172637	142x53 mm	PVD	1	-	8
	17264	172644	142x53 mm	NE	1	-	8
	17265	172651	142x53 mm	BL	1	-	8

Ángulo curvo

Acero Inoxidable

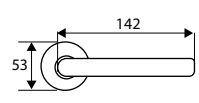

MANILLÓN PLACA 585



	Código	843 I 488	Medida	Acabado			€uros
Caja	05758	057583	225x42 mm	INOX	-	1	50
	05759	057590	225x42 mm	PVD	-	1	50
	05760	057606	225x42 mm	NE	-	1	50
	05761	057613	225x42 mm	BL	-	1	50

Acero Inoxidable

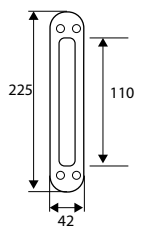

MANILLÓN ASA CORTA C/BOCALLAVE 585

	Código	8431488	Medida	Acabado				€uros
Caja	05766	057668	225x42 mm	INOX	-	1	50	
	05767	057675	225x42 mm	PVD	-	1	50	
	05768	057682	225x42 mm	NE	-	1	50	
	05769	057699	225x42 mm	BL	-	1	50	

Acero Inoxidable

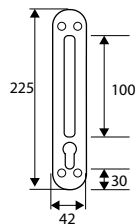

MANILLÓN POMO FIJO C/BOCALLAVE 585

	Código	8431488	Medida	Acabado				€uros
Caja	05762	057620	225x42 mm	INOX	-	1	50	
	05763	057637	225x42 mm	PVD	-	1	50	
	05764	057644	225x42 mm	NE	-	1	50	
	05765	057651	225x42 mm	BL	-	1	50	

Acero Inoxidable

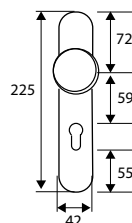

TIRADOR ARMARIO S/BOCA 575

	Código	8431488	Medida	Acabado				€uros
Caja	56510	565101	112x30 mm	INOX	-	10	200	

Acero Inoxidable

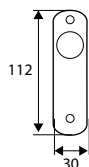

TIRADOR MALETERO 575

	Código	8431488	Medida	Acabado				€uros
Caja	56513	565132	55x30 mm	INOX	-	10	200	
Blister	91580	915807	55x30 mm	INOX	1	-	10	

Acero Inoxidable

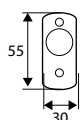

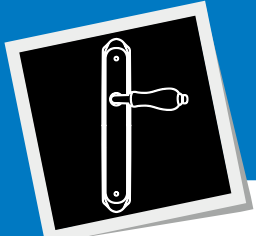

JGO MANILLA 515



	Código	8431488	Medida	Acabado				€uros
Caja	05154	051543	225x42 mm	INOX	-	1	20	
	05155	051550	225x42 mm	PVD	-	1	20	
	05156	051567	225x42 mm	NE	-	1	20	
	05157	051574	225x42 mm	BL	-	1	20	
Blister	17244	172446	225x42 mm	INOX	1	-	8	
	17245	172453	225x42 mm	PVD	1	-	8	
	17246	172460	225x42 mm	NE	1	-	8	
	17247	172477	225x42 mm	BL	1	-	8	

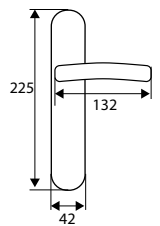

Acero Inoxidable



JGO ROSETA 515



	Código	8431488	Medida	Acabado				€uros
Caja	00515	005157	132x53 mm	INOX	-	1	20	
	05151	051512	132x53 mm	PVD	-	1	20	
	05152	051529	132x53 mm	NE	-	1	20	
	05153	051536	132x53 mm	BL	-	1	20	
Blister	17248	172484	132x53 mm	INOX	1	-	8	
	17249	172491	132x53 mm	PVD	1	-	8	
	17250	172507	132x53 mm	NE	1	-	8	
	17251	172514	132x53 mm	BL	1	-	8	

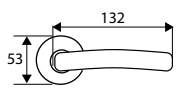

Acero Inoxidable



JGO ROSETA 545



	Código	8431488	Medida	Acabado				€uros
Caja	00545	005454	130x54 mm	INOX	-	1	20	
Blister	17154	171548	130x54 mm	INOX	1	-	8	

Escudo a rosca

Acero Inoxidable

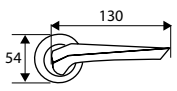

JGO ROSETA 737



	Código	8431488	Medida	Acabado				€uros
Caja	00737	007373	130x52 mm	INOX	-	1	20	
Blister	17194	171944	130x52 mm	INOX	1	-	8	

Acero Inoxidable

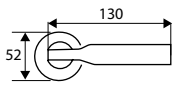

JGO ROSETA 595

	Código	8431488	Medida	Acabado				€uros
Caja	00595	005959	120x52 mm	INOX	-	1	20	
Blister	17001	170015	120x52 mm	INOX	1	-	8	

Acero Inoxidable

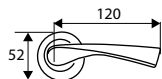

MANILLÓN ROSETA 595

	Código	8431488	Medida	Acabado				€uros
Caja	59516	595160	200 mm	INOX	-	1	50	

Acero Inoxidable

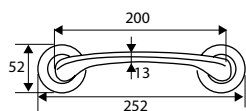

JGO ROSETA 636

	Código	8431488	Medida	Acabado				€uros
Caja	00636	006369	130x52 mm	INOX	-	1	20	
Blister	17192	171920	130x52 mm	INOX	1	-	8	

Acero Inoxidable

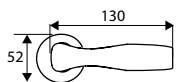

JGO ROSETA 747

	Código	8431488	Medida	Acabado				€uros
Caja	00747	007472	95x53 mm	INOX	-	1	20	
Blister	17195	171951	95x53 mm	INOX	1	-	8	

Acero Inoxidable

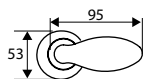

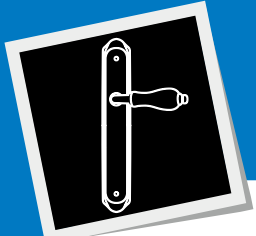

JGO ROSETA CUADRADA 191



	Código	8431488	Medida	Acabado				€uros
Caja	00191	001913	120x54 mm	INOX	-	1	20	
Blister	17189	171890	120x54 mm	INOX	1	-	8	

Acero Inoxidable

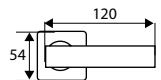

JGO ROSETA CUADRADA 131



	Código	8431488	Medida	Acabado				€uros
Caja	00131	001319	125x52 mm	INOX	-	1	20	
Blister	17187	171876	125x52 mm	INOX	1	-	8	

Acero Inoxidable

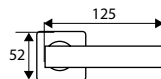

JGO ROSETA CUADRADA 161



	Código	8431488	Medida	Acabado				€uros
Caja	00161	001616	130x52 mm	INOX	-	1	20	
Blister	17188	171883	130x52 mm	INOX	1	-	8	

Acero Inoxidable

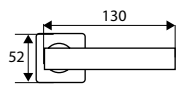

JGO ROSETA CUADRADA 676



	Código	8431488	Medida	Acabado				€uros
Caja	00676	006765	120x52 mm	INOX	-	1	20	
Blister	17191	171913	120x52 mm	INOX	1	-	8	

Acero Inoxidable

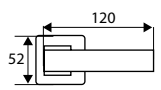

JGO ROSETA CUADRADA 656

	Código	8431488	Medida	Acabado				€uros
Caja	00656	006567	125x52 mm	INOX	-	1	20	
Blister	17190	171906	125x52 mm	INOX	1	-	8	

Acero Inoxidable

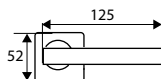

MANILLÓN ROSETA CUADRADO 656

	Código	8431488	Medida	Acabado				€uros
Caja	22301	223018	200 mm	INOX	-	1	40	

Acero Inoxidable

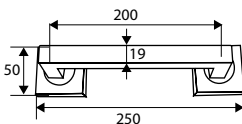

MANILLÓN CUADRADO 656

	Código	8431488	Medida A	Acabado				€uros
Caja	22150	221502	150x19 mm	INOX	-	2	40	
	22200	222004	200x19 mm	INOX	-	2	40	
	22250	222509	250x19 mm	INOX	-	2	40	
	22300	223001	300x19 mm	INOX	-	2	40	

Acero Inoxidable

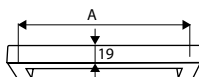

JGO ROSETA 767

	Código	8431488	Medida	Acabado				€uros
Caja	00767	007670	123x52 mm	INOX	-	1	20	
Blister	17196	171968	123x52mm	INOX	1	-	8	

Acero Inoxidable

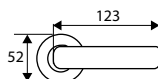

JGO ROSETA 717

	Código	8431488	Medida	Acabado				€uros
Caja	00717	007175	125x50 mm	INOX	-	1	20	
Blister	17193	171937	125x50 mm	INOX	1	-	8	

Acero Inoxidable

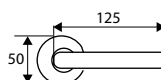

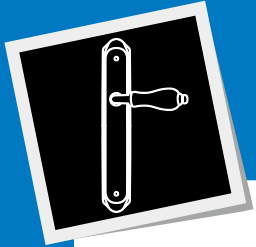

JGO MANILLA 272

	Código	8431488	Medida	Acabado				€uros
Caja	00272	002729	275x45 mm	NE	-	1	20	
Blister	17051	170510	275x45 mm	NE	1	-	8	

Placa: Acero
Maneta: Aluminio



NEGRO

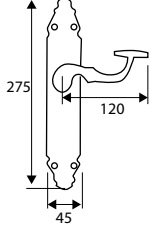

JGO MANILLA S/PLACA 272

	Código	8431488	Medida	Acabado				€uros
	02721	027210	135 mm	NE	-	1	5	

Acero



NEGRO

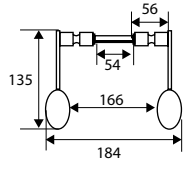

MANILLÓN PLACA 272

	Código	8431488	Medida	Acabado				€uros
Caja	27216	272160	275x45 mm	NE	-	1	50	

Placa: Acero
Asa: Aluminio



NEGRO

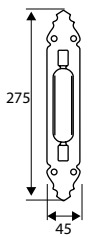

JGO MANILLA 242

	Código	8431488	Medida	Acabado				€uros
Caja	00242	002422	275x45 mm	NE	-	1	20	
Blistar	17052	170527	275x45 mm	NE	1	-	8	

Placa: Acero
Maneta: Aluminio



NEGRO

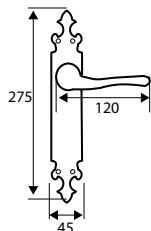

JGO MANILLA S/PLACA 242

	Código	8431488	Medida	Acabado				€uros
	02421	024219	130 mm	NE	-	1	5	

Acero



NEGRO

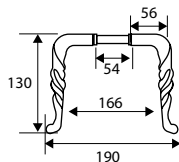

MANILLÓN PLACA 242

	Código	8431488	Medida	Acabado				€uros
Caja	24216	242163	275x45 mm	NE	-	1	50	

Placa: Acero
Asa: Aluminio



NEGRO

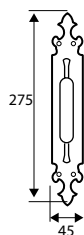

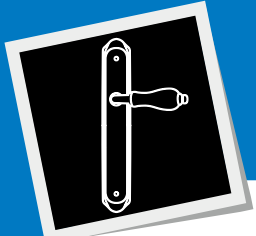

JGO MANILLA 282

	Código	8431488	Medida	Acabado				€uros
Caja	00282	002828	275x45 mm	NE	-	1	20	
Blister	17053	170534	275x45 mm	NE	1	-	8	

Placa: Acero
Maneta: Zamak

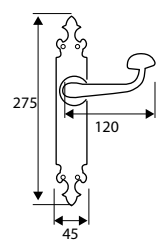

JGO MANILLA S/PLACA 282

	Código	8431488	Medida	Acabado				€uros
	02821	028217	135 mm	NE	-	1	5	

Acero

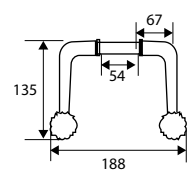

JGO MANILLA 292

	Código	8431488	Medida	Acabado				€uros
Caja	00292	002927	275x45 mm	NE	-	1	20	
Blister	17054	170541	275x45 mm	NE	1	-	8	

Placa: Acero
Maneta: Aluminio

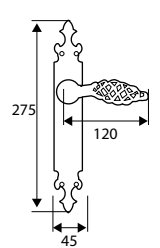

JGO MANILLA S/PLACA 292

	Código	8431488	Medida	Acabado				€uros
	02921	029214	130 mm	NE	-	1	5	

Acero

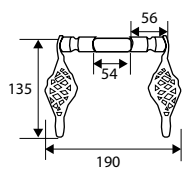

JGO MANILLA 252

	Código	8431488	Medida	Acabado				€uros
Caja	00252	002521	275x45 mm	NE	-	1	20	
Blister	17219	172194	275x45 mm	NE	1	-	8	

Placa: Acero
Maneta: Aluminio

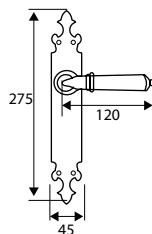

JGO ROSETA 020

	Código	8431488	Medida	Acabado				€uros
Caja	02001	020013	123x50 mm	NE	-	1	30	
Blister	17272	172729	123x50 mm	NE	1	-	8	

Zamak

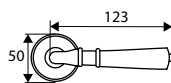

TIRADOR ARMARIO S/BOCA 242

	Código	8431488	Medida	Acabado				€uros
Caja	24210	242101	145x30 mm	NE	-	10	200	
Blister	91583	915838	145x30 mm	NE	1	-	10	

Placa: Acero
Pomo: Aluminio

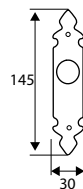

TIRADOR MALETERO 242

	Código	8431488	Medida	Acabado				€uros
Caja	24213	242132	90x30 mm	NE	-	10	200	
Blister	91582	915821	90x30 mm	NE	1	-	10	

Placa: Acero
Pomo: Aluminio

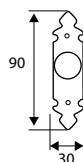

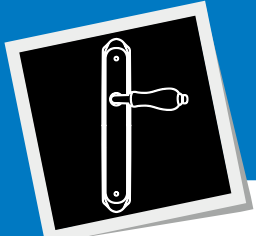

JGO MANILLA PORCELANA 686

	Código	8431488	Medida	Acabado				€uros
Caja	06866	006864	265x50 mm	LE	-	1	20	
Blister	17118	171180	265x50 mm	LE	1	-	8	

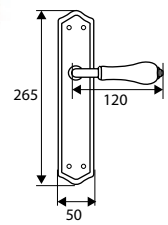

Latón



JGO ROSETA PORCELANA 686

	Código	8431488	Medida	Acabado				€uros
Caja	06861	068619	120x50 mm	LE	-	1	20	
Blister	17119	171197	120x50 mm	LE	1	-	8	

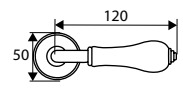

Latón



MANILLÓN ROSETA PORCELANA 686

	Código	8431488	Medida	Acabado				€uros
Caja	68616	686165	225x50 mm	LE	-	2	40	

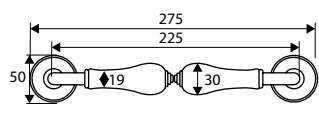

Latón



TIRADOR ARMARIO S/BOCA 686

	Código	8431488	Medida	Acabado				€uros
Caja	68610	686103	119x34 mm	LE	-	10	200	
Blister	91585	915852	119x34 mm	LE	1	-	10	

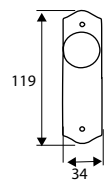

Latón



TIRADOR MALETERO 686

	Código	8431488	Medida	Acabado				€uros
Caja	68613	686134	80x34 mm	LE	-	10	200	
Blister	91584	915845	80x34 mm	LE	1	-	10	

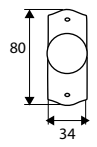

Latón



JGO MANILLA PORCELANA 787

	Código	8431488	Medida	Acabado				€uros
Caja	07872	078724	260x45 mm	CU	-	1	20	
	07871	078717	260x45 mm	LE	-	1	20	
Blister	17005	170053	260x45 mm	CU	1	-	8	
	17006	170060	260x45 mm	LE	1	-	8	

Zamak

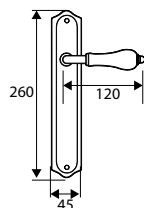

JGO ROSETA PORCELANA 787

	Código	8431488	Medida	Acabado				€uros
Caja	07874	078748	120x50 mm	CU	-	1	30	
	07873	078731	120x50 mm	LE	-	1	30	
	07876	078762	120x50 mm	PE	-	1	30	
Blister	17008	170084	120x50 mm	CU	1	-	8	
	17009	170091	120x50 mm	LE	1	-	8	
	17010	170107	120x50 mm	PE	1	-	8	

Zamak

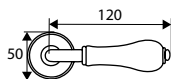

MANILLÓN ROSETA PORCELANA 787

	Código	8431488	Medida	Acabado				€uros
Caja	78746	787466	210x50 mm	CU	-	2	40	
	78736	787367	210x50 mm	LE	-	2	40	
	78796	787961	210x50 mm	PE	-	2	40	

Zamak

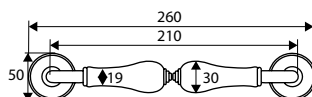

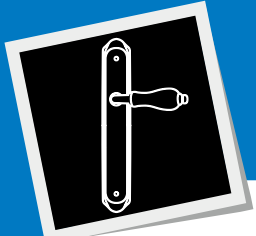

JGO MANILLA 343



	Código	8431488	Medida	Acabado				€uros
Caja	00343	003436	240x44 mm	LP	-	1	20	
	03432	034324	240x44 mm	NS	-	1	20	
Blister	17120	171203	240x44 mm	LP	1	-	8	
	17121	171210	240x44 mm	NS	1	-	8	

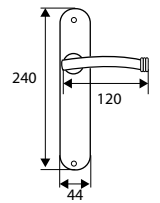

Latón

LATÓN PULIDO

NÍQUEL SATINADO

JGO MANILLA 727



	Código	8431488	Medida	Acabado				€uros
Caja	00727	007274	249x40 mm	LP	-	1	20	
	07272	072722	249x40 mm	NS	-	1	20	
Blister	17114	171142	249x40 mm	LP	1	-	8	
	17115	171159	249x40 mm	NS	1	-	8	

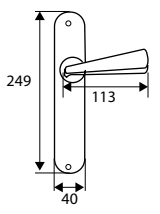

Latón

LATÓN PULIDO

NÍQUEL SATINADO

JGO ROSETA 727



	Código	8431488	Medida	Acabado				€uros
Caja	07273	072739	113x50 mm	LP	-	1	22	
	07275	072753	113x50 mm	NS	-	1	22	
Blister	17116	171166	113x50 mm	LP	1	-	8	
	17117	171173	113x50 mm	NS	1	-	8	

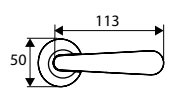

Latón

LATÓN PULIDO

NÍQUEL SATINADO

MANILLÓN PLACA 727

	Código	8431488	Medida	Acabado				€uros
Caja	72716	727165	249x40 mm	LP	-	2	40	
	72736	727363	249x40 mm	NS	-	2	40	

Latón

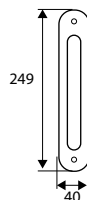

MANILLÓN ROSETA 727

	Código	8431488	Medida	Acabado				€uros
Caja	00212	002125	200 mm	LP	-	2	40	
	02122	021225	200 mm	NS	-	2	40	

Latón

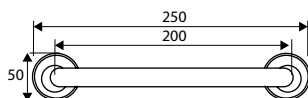

TIRADOR ARMARIO S/BOCA 727

	Código	8431488	Medida	Acabado				€uros
Caja	10023	100234	112x30 mm	LP	-	10	200	
	10033	100333	112x30 mm	NS	-	10	200	
Blister	91588	915883	112x30 mm	LP	1	-	10	
	91589	915890	112x30 mm	NS	1	-	10	

Latón

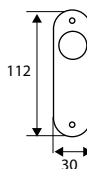

TIRADOR MALETERO 727

	Código	8431488	Medida	Acabado				€uros
Caja	10025	100258	65x30 mm	LP	-	10	200	
	10035	100357	65x30 mm	NS	-	10	200	
Blister	91586	915869	65x30 mm	LP	1	-	10	
	91587	915876	65x30 mm	NS	1	-	10	

Latón

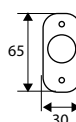

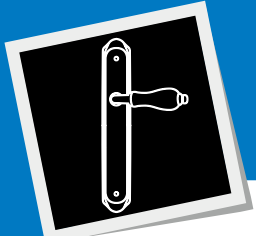

JGO MANILLA 505

	Código	8431488	Medida	Acabado				€uros
Caja	00505	005058	265x50 mm	BI	-	1	20	
	05051	050515	265x50 mm	CU	-	1	20	
Blister	17112	171128	265x50 mm	BI	1	-	8	
	17113	171135	265x50 mm	CU	1	-	8	

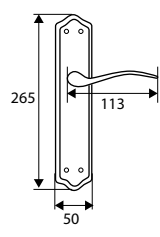

Latón
 Latón
 BIORO
 CUERO



MANILLÓN PLACA 505

	Código	8431488	Medida	Acabado				€uros
Caja	50546	505466	265x50mm	CU	-	2	40	

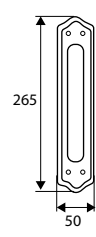

Latón
 Latón
 CUERO



TIRADOR ARMARIO S/BOCA 505

	Código	8431488	Medida	Acabado				€uros
Caja	50540	505404	119x34 mm	CU	-	10	200	
Blister	91591	915913	119x34 mm	CU	1	-	10	

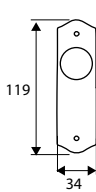

Latón
 Latón
 CUERO



TIRADOR MALETERO 505

	Código	8431488	Medida	Acabado				€uros
Caja	50543	505435	80x34 mm	CU	-	10	200	
Blister	91590	915906	80x34 mm	CU	1	-	10	

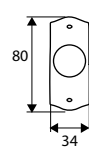

Latón
 Latón
 CUERO

MANILLÓN ASA CORTA 505

	Código	8431488	Medida	Acabado				€uros
Caja	05052	050522	265x50 mm	BI	-	2	30	
	05054	050546	265x50 mm	LP	-	2	30	
	05056	050560	265x50 mm	NS	-	2	30	

Latón

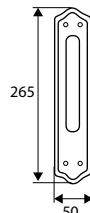

MANILLÓN POMO FIJO 505

	Código	8431488	Medida	Acabado				€uros
Caja	05053	050539	265x50 mm	BI	-	2	30	
	05055	050553	265x50 mm	LP	-	2	30	
	05057	050577	265x50 mm	NS	-	2	30	

Latón

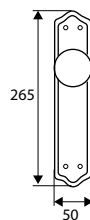

JGO MANILLA 919

	Código	8431488	Medida	Acabado				€uros
Caja	09192	091921	260x45 mm	CU	-	1	20	
	09193	091938	260x45 mm	NS	-	1	20	
Blister	17024	170244	260x45 mm	CU	1	-	8	
	17025	170251	260x45 mm	NS	1	-	8	

Zamak

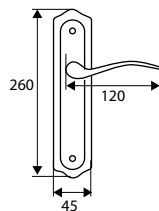

JGO ROSETA 919

	Código	8431488	Medida	Acabado				€uros
Caja	09195	091952	125x50 mm	CU	-	1	30	
	09196	091969	125x50 mm	NS	-	1	30	
Blister	17026	170268	125x50 mm	CU	1	-	8	
	17027	170275	125x50 mm	NS	1	-	8	

Zamak

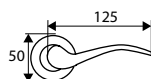

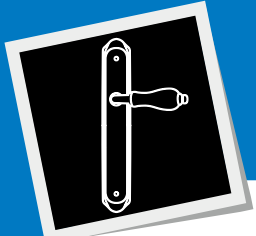

JGO MANILLA 202



	Código	8431488	Medida	Acabado				€uros
Caja	02021	020211	256x47 mm	LTD	-	1	20	
	02022	020228	256x47 mm	BI	-	1	20	
	02023	020235	256x47 mm	NS	-	1	20	
	02024	020242	256x47 mm	CU	-	1	20	
	02033	020334	256x47 mm	NE	-	1	20	
Blister	17014	170145	256x47 mm	LTD	1	-	8	
	17015	170152	256x47 mm	BI	1	-	8	
	17016	170169	256x47 mm	NS	1	-	8	
	17017	170176	256x47 mm	CU	1	-	8	
	17217	172170	256x47 mm	NE	1	-	8	

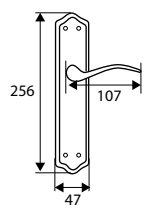

Placa: Acero
Maneta: Aluminio

LATONADO
 BIORO
 NIQUEL SATINADO
 CUERO
 NEGRO

JGO ROSETA 202



	Código	8431488	Medida	Acabado				€uros
Caja	02029	020297	105x50 mm	LTD	-	1	40	
	02030	020303	105x50 mm	BI	-	1	40	
	02031	020310	105x50 mm	NS	-	1	40	
	02032	020327	105x50 mm	CU	-	1	40	
	02034	020341	105x50 mm	NE	-	1	40	
Blister	17157	171579	105x50 mm	LTD	1	-	8	
	17158	171586	105x50 mm	BI	1	-	8	
	17159	171593	105x50 mm	NS	1	-	8	
	17160	171609	105x50 mm	CU	1	-	8	
	17218	172187	105x50 mm	NE	1	-	8	

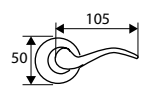

Aluminio

LATONADO
 BIORO
 NIQUEL SATINADO
 CUERO
 NEGRO

MANILLÓN PLACA 202



	Código	8431488	Medida	Acabado				€uros
Caja	02025	020259	256x47 mm	LTD	-	1	40	
	02026	020266	256x47 mm	BI	-	1	40	
	02027	020273	256x47 mm	NS	-	1	40	
	02028	020280	256x47 mm	CU	-	1	40	
	02035	020358	256x47 mm	NE	-	1	40	

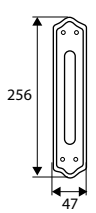

Placa: Acero
Asa: Aluminio

LATONADO
 BIORO
 NIQUEL SATINADO
 CUERO
 NEGRO

JGO MANILLA 010

	Código	8431488	Medida	Acabado				Euros
Caja	01001	010014	260x45 mm	BI	-	1	20	
	01002	010021	260x45 mm	CU	-	1	20	
	01003	010038	260x45 mm	NS	-	1	20	
Blister	17228	172286	260x45 mm	BI	1	-	8	
	17229	172293	260x45 mm	CU	1	-	8	
	17230	172309	260x45 mm	NS	1	-	8	

Placa: Acero
Maneta: Zamak

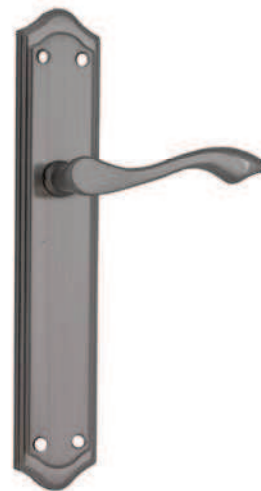
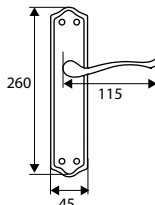

JGO MANILLA 797

	Código	8431488	Medida	Acabado				Euros
Caja	07971	079714	240x45 mm	LTD	-	1	20	
	07972	079721	240x45 mm	NS	-	1	20	
Blister	17224	172248	240x45 mm	LTD	1	-	8	
	17225	172255	240x45 mm	NS	1	-	8	

Placa: Acero
Maneta: Aluminio

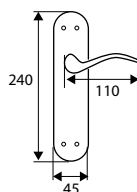

MANILLÓN PLACA 797

	Código	8431488	Medida	Acabado				Euros
Caja	07973	079738	240x45 mm	LTD	-	1	40	
	07974	079745	240x45 mm	NS	-	1	40	

Placa: Acero
Asa: Aluminio

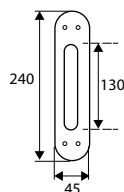
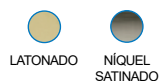

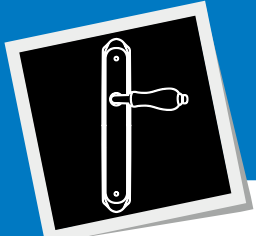

JGO MANILLA 777

	Código	8431488	Medida	Acabado				€uros
Caja	00777	007779	243x45 mm	LP	-	1	20	
Blister	17019	170190	243x45 mm	LP	1	-	8	

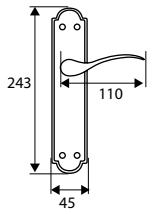

Latón

 LATÓN PULIDO



MANILLÓN PLACA 777

	Código	8431488	Medida	Acabado				€uros
Caja	77716	777160	243x45 mm	LP	-	2	40	

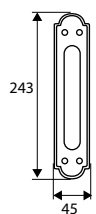

Latón

 LATÓN PULIDO



PLACA LIMPIEZA 777

	Código	8431488	Medida	Acabado				€uros
	77711	777115	243x45 mm	LP	-	1	10	

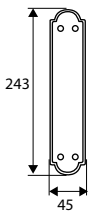

Latón

 LATÓN PULIDO

JGO MANILLA 1777

	Código	8431488	Medida	Acabado				€uros
Caja	01777	077796	240x45 mm	LTD	-	1	20	
	17771	177717	240x45 mm	CU	-	1	20	
Blister	17021	170213	240x45 mm	LTD	1	-	8	
	17183	171838	240x45 mm	CU	1	-	8	

Placa: Acero
Maneta: Aluminio

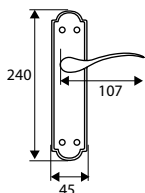

MANILLÓN PLACA 1777

	Código	8431488	Medida	Acabado				€uros
Caja	17776	177762	240x45 mm	LTD	-	1	40	

Placa: Acero
Asa: Aluminio

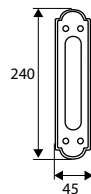

TIRADOR ARMARIO S/BOCA 777

	Código	8431488	Medida	Acabado				€uros
Caja	77710	777108	125x33 mm	LP	-	10	200	
Blister	91595	915951	125x33 mm	LP	1	-	10	

Latón

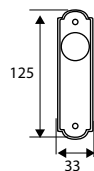

TIRADOR MALETERO 777

	Código	8431488	Medida	Acabado				€uros
Caja	77713	777139	65x33 mm	LP	-	10	200	
Blister	91594	915944	65x33 mm	LP	1	-	10	

Latón

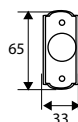

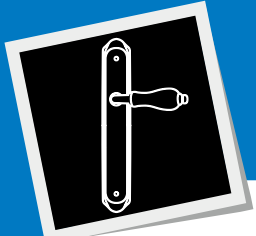

JGO MANILLA 666

	Código	8431488	Medida	Acabado				€uros
Caja	00666	006666	243x45 mm	LP	-	1	20	
Blister	17011	170114	243x45 mm	LP	1	-	8	

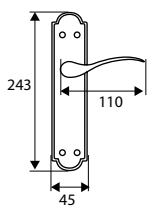

Latón

 LATÓN PULIDO

MANILLÓN PLACA 666

	Código	8431488	Medida	Acabado				€uros
Caja	66616	666167	243x45 mm	LP	-	2	40	

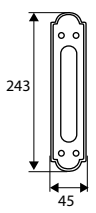

Latón

 LATÓN PULIDO

PLACA LIMPIEZA 666

	Código	8431488	Medida	Acabado				€uros
	66611	666112	243x45 mm	LP	-	1	10	

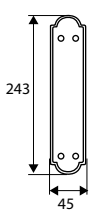

Latón

 LATÓN PULIDO

JGO MANILLA 1666

	Código	8431488	Medida	Acabado				€uros
Caja	01666	016665	250x45 mm	LTD	-	1	20	
Blister	17013	170138	250x45 mm	LTD	1	-	8	

Placa: Acero
Maneta: Aluminio

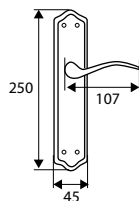

MANILLÓN PLACA 1666

	Código	8431488	Medida	Acabado				€uros
Caja	16666	166667	250x45 mm	LTD	-	1	40	

Placa: Acero
Asa: Aluminio

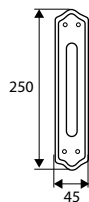

TIRADOR ARMARIO S/BOCA 666

	Código	8431488	Medida	Acabado				€uros
Caja	66610	666105	125x33 mm	LP	-	10	200	
Blister	91593	915937	125x33 mm	LP	1	-	10	

Latón

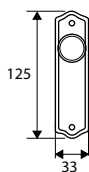

TIRADOR MALETERO 666

	Código	8431488	Medida	Acabado				€uros
Caja	66613	666136	65x33mm	LP	-	10	200	
Blister	91592	915920	65x33 mm	LP	1	-	10	

Latón

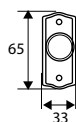

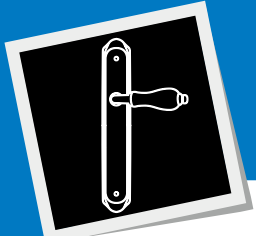

JGO MANILLA 1646

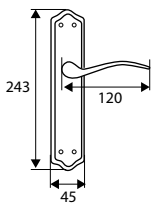

	Código	8431488	Medida	Acabado				€uros
Caja	01646	016467	243x45 mm	LTD	-	1	20	
	01647	016474	243x45 mm	CU	-	1	20	
Blister	17022	170220	243x45 mm	LTD	1	-	8	
	17023	170237	243x45 mm	CU	1	-	8	

Placa: Acero
Maneta: Aluminio

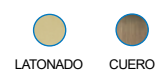

JGO MANILLA 327

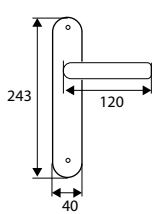

	Código	8431488	Medida	Acabado				€uros
Caja	03271	032719	243x40 mm	NS	-	1	20	
Blister	17226	172262	243x40 mm	NS	1	-	8	

Placa: Acero
Maneta: Zamak



JGO ROSETA 327

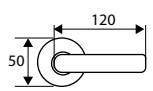

	Código	8431488	Medida	Acabado				€uros
Caja	03272	032726	120x50 mm	NS	-	1	20	
Blister	17227	172279	120x50 mm	NS	1	-	8	

Zamak



JGO MANILLA 989

	Código	8431488	Medida	Acabado				€uros
Caja	00989	009896	242x41 mm	NS	-	1	20	
Blister	17028	170282	242x41 mm	NS	1	-	8	

Placa: Acero
Maneta: Zamak

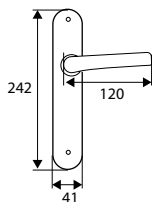

JGO MANILLA 959

	Código	8431488	Medida	Acabado				€uros
Caja	00959	009599	242x41 mm	NS	-	1	20	
Blister	17029	170299	242x41 mm	NS	1	-	8	

Placa: Acero
Maneta: Zamak

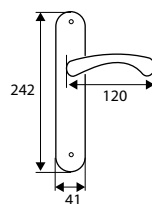

JGO ROSETA 959

	Código	8431488	Medida	Acabado				€uros
Caja	09591	095912	120x50 mm	NS	-	1	30	
Blister	17030	170305	120x50 mm	NS	1	-	8	

Zamak

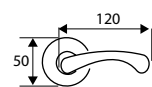

MANILLÓN ROSETA 989

	Código	8431488	Medida	Acabado				€uros
Caja	98936	989365	170 mm	NS	-	2	40	

Zamak

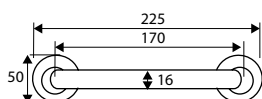

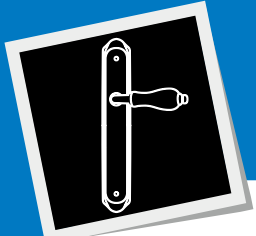

JGO ROSETA CUADRADA 090

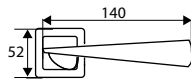

	Código	8431488	Medida	Acabado				€uros
Caja	00901	009018	140x52 mm	NM	-	1	20	
	00902	009025	140x52 mm	NN	-	1	20	
Blister	17205	172057	140x52 mm	NM	1	-	8	
	17206	172064	140x52 mm	NN	1	-	8	

Zamak



JGO ROSETA CUADRADA 848

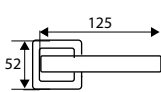
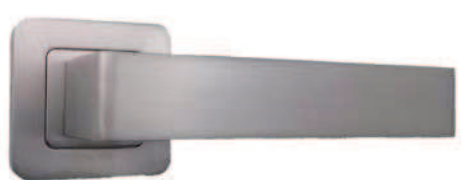

	Código	8431488	Medida	Acabado				€uros
Caja	08481	084817	125x52 mm	NM	-	1	20	
	08482	084824	125x52 mm	NN	-	1	20	
Blister	17198	171982	125x52 mm	NM	1	-	8	
	17199	171999	125x52 mm	NN	1	-	8	

Zamak

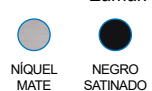

JGO ROSETA CUADRADA 969

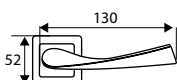

	Código	8431488	Medida	Acabado				€uros
Caja	09691	096919	130x52 mm	NM	-	1	20	
	09692	096926	130x52 mm	NN	-	1	20	
Blister	17203	172033	130x52 mm	NM	1	-	8	
	17204	172040	130x52 mm	NN	1	-	8	

Zamak

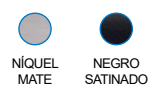

JGO ROSETA 898

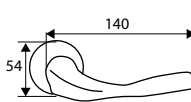

	Código	8431488	Medida	Acabado				€uros
Caja	08981	089812	140x54 mm	NM	-	1	20	
	08982	089829	140x54 mm	NN	-	1	20	
Blister	17200	172002	140x54 mm	NM	1	-	8	
	17201	172019	140x54 mm	NN	1	-	8	

Zamak



JGO ROSETA 949

	Código	8431488	Medida	Acabado				€uros
Caja	09491	094915	120X54 mm	CB	-	1	20	
Blister	17202	172026	120X54 mm	CB	1	-	8	

Zamak

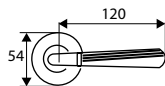

JGO ROSETA 494

	Código	8431488	Medida	Acabado				€uros
Caja	04941	049410	120x50 mm	NS	-	1	40	
	04942	049427	120x50 mm	LTD	-	1	40	
	04943	049434	120x50 mm	CU	-	1	40	
Blister	17176	171760	120x50 mm	NS	1	-	8	
	17177	171777	120x50 mm	LTD	1	-	8	
	17178	171784	120x50 mm	CU	1	-	8	

Aluminio

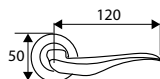

JGO ROSETA 474

	Código	8431488	Medida	Acabado				€uros
Caja	04741	047416	125x50 mm	NS	-	1	40	
Blister	17173	171739	125x50 mm	NS	1	-	8	

Aluminio

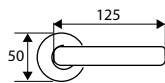

JGO ROSETA 363

	Código	8431488	Medida	Acabado				€uros
Caja	03631	036311	127x50 mm	CN	-	1	40	
Blister	17163	171630	127x50 mm	CN	1	-	8	

Aluminio

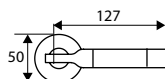

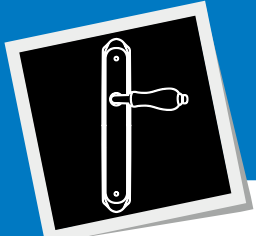

JGO MANILLA 707



	Código	8431488	Medida	Acabado				€uros
Caja	07073	070735	240x45 mm	LS	-	1	20	
	07074	070742	240x45 mm	NS	-	1	20	
Blister	17031	170312	240x45 mm	LS	1	-	8	
	17032	170329	240x45 mm	NS	1	-	8	

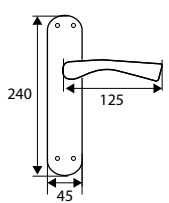

Placa: Acero
Maneta: Aluminio

LATÓN SATINADO NÍQUEL SATINADO

JGO MANILLA 707 (PLACA ANCHA)



	Código	8431488	Medida	Acabado				€uros
Caja	07078	070780	240x60 mm	LTD	-	1	20	
	07079	070797	240x60 mm	NS	-	1	20	
Blister	17290	172903	240x60 mm	LTD	1	-	8	
	17291	172910	240x60 mm	NS	1	-	8	

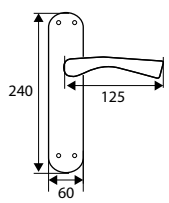

Placa: Acero
Maneta: Aluminio

LATÓNADO NÍQUEL SATINADO

JGO ROSETA 707



	Código	8431488	Medida	Acabado				€uros
Caja	07071	070711	125x50 mm	LS	-	1	40	
	07072	070728	125x50 mm	NS	-	1	40	
	07075	070759	125x50 mm	CB	-	1	40	
	07077	070773	125x50 mm	NE	-	1	40	
Blister	17033	170336	125x50 mm	LS	1	-	8	
	17034	170343	125x50 mm	NS	1	-	8	
	17184	171845	125x50 mm	CB	1	-	8	
	17274	172743	125x50 mm	NE	1	-	8	

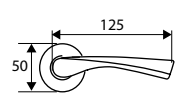

Aluminio

LATÓN SATINADO NÍQUEL SATINADO CROMO BRILLO NEGRO

MANILLÓN ROSETA 707



	Código	8431488	Medida	Acabado				€uros
Caja	70716	707167	200 mm	LS	-	1	40	
	70736	707365	200 mm	NS	-	1	40	

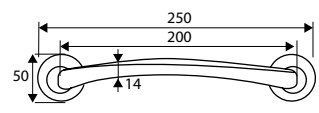

Aluminio

LATÓN SATINADO NÍQUEL SATINADO

JGO MANILLA 606

	Código	8431488	Medida	Acabado				€uros
Caja	06064	060644	240x45 mm	LS	-	1	20	
	06065	060651	240x45 mm	NS	-	1	20	
	06066	060668	240x45 mm	CU	-	1	20	
Blister	17041	170411	240x45 mm	LS	1	-	8	
	17042	170428	240x45 mm	NS	1	-	8	
	17040	170404	240x45 mm	CU	1	-	8	

Placa: Acero

Maneta: Aluminio

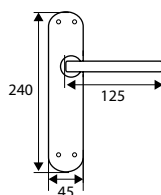

JGO ROSETA 606

	Código	8431488	Medida	Acabado				€uros
Caja	06061	060613	120x50 mm	LS	-	1	40	
	06062	060620	120x50 mm	NS	-	1	40	
	06063	060637	120x50 mm	CN	-	1	40	
	06067	060675	120x50 mm	CU	-	1	40	
	06068	060682	120x50 mm	NE	-	1	40	
Blister	17045	170459	120x50 mm	LS	1	-	8	
	17046	170466	120x50 mm	NS	1	-	8	
	17043	170435	120x50 mm	CN	1	-	8	
	17044	170442	120x50 mm	CU	1	-	8	
	17273	172736	120x50 mm	NE	1	-	8	

Aluminio

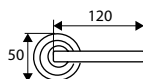

MANILLÓN ROSETA 606

	Código	8431488	Medida	Acabado				€uros
Caja	60636	606361	200 mm	NS	-	1	40	

Aluminio

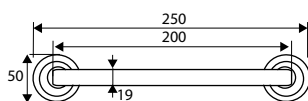

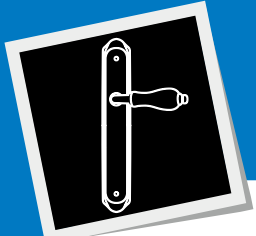

JGO ROSETA CUADRADA 616



	Código	8431488	Medida	Acabado				€uros
Caja	06161	061610	120x52 mm	LS	-	1	40	
	06162	061627	120x52 mm	NS	-	1	40	
	06163	061634	120x52 mm	CN	-	1	40	
	06164	061641	120x52 mm	CU	-	1	40	
Blister	17049	170497	120x52 mm	LS	1	-	8	
	17050	170503	120x52 mm	NS	1	-	8	
	17047	170473	120x52 mm	CN	1	-	8	
	17048	170480	120x52 mm	CU	1	-	8	

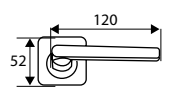

- Aluminio
- LATÓN SATINADO
 - NÍQUEL SATINADO
 - CROMO BRILLO/ NÍQUEL SATINADO
 - CUERO

JGO ROSETA CUADRADA 868

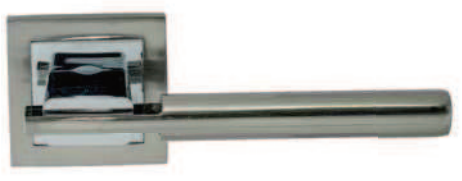

	Código	8431488	Medida	Acabado				€uros
Caja	00868	008684	140x55 mm	CN	-	1	20	
Blister	17035	170350	140x55 mm	CN	1	-	8	

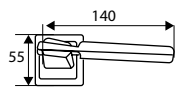

- Aluminio
- CROMO BRILLO/ NÍQUEL SATINADO



Presentación en estuche Deluxe

JGO ROSETA CUADRADA 878



	Código	8431488	Medida	Acabado				€uros
Caja	00878	008783	155x55 mm	NS	-	1	20	
Blister	17036	170367	155x55 mm	NS	1	-	8	

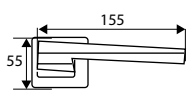

- Aluminio
- NÍQUEL SATINADO



Presentación en estuche Deluxe

JGO ROSETA CUADRADA 434

	Código	8431488	Medida	Acabado				€uros
Caja	04341	043418	120x50 mm	NS	-	1	40	
Blister	17169	171692	120x50 mm	NS	1	-	8	

Aluminio

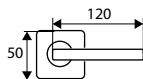

JGO ROSETA CUADRADA 464

	Código	8431488	Medida	Acabado				€uros
Caja	04641	046419	115x50 mm	NS	-	1	40	
Blister	17171	171715	115x50 mm	NS	1	-	8	

Aluminio

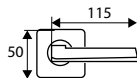

JGO ROSETA CUADRADA 424

	Código	8431488	Medida	Acabado				€uros
Caja	04241	042411	125x50 mm	NS	-	1	40	
Blister	17168	171685	125x50 mm	NS	1	-	8	

Aluminio

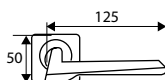

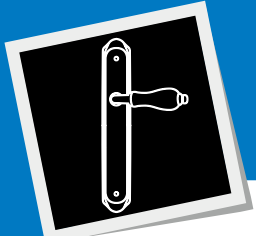

JGO ROSETA 454



	Código	8431488	Medida	Acabado				€uros
Caja	04541	045412	128x50 mm	NS	-	1	40	
Blister	17170	171708	128x50 mm	NS	1	-	8	

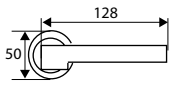

Aluminio



JGO ROSETA 393



	Código	8431488	Medida	Acabado				€uros
Caja	03931	039312	123x50 mm	NS	-	1	40	
Blister	17167	171678	123x50 mm	NS	1	-	8	

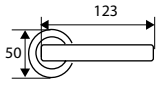

Aluminio



JGO ROSETA 101



	Código	8431488	Medida	Acabado				€uros
Caja	01011	010113	120x50 mm	NS	-	1	40	
	01012	010120	120x50 mm	LTD	-	1	40	
Blister	17181	171814	120x50 mm	NS	1	-	8	
	17182	171821	120x50 mm	LTD	1	-	8	

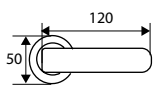

Aluminio



JGO ROSETA 464



	Código	8431488	Medida	Acabado				€uros
Caja	04642	046426	115x50 mm	NS	-	1	40	
Blister	17172	171722	115x50 mm	NS	1	-	8	

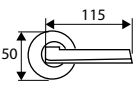

Aluminio



JGO ROSETA 383

	Código	8431488	Medida	Acabado				€uros
Caja	03831	038315	125x50 mm	NS	-	1	40	
	03832	038322	125x50 mm	LTD	-	1	40	
Blister	17165	171654	125x50 mm	NS	1	-	8	
	17166	171661	125x50 mm	LTD	1	-	8	

Zamak

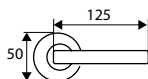

JGO ROSETA 313

	Código	8431488	Medida	Acabado				€uros
Caja	03131	031316	123x50 mm	NS	-	1	40	
Blister	17161	171616	123x50 mm	NS	1	-	8	

Aluminio

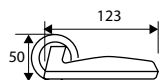

JGO ROSETA 303

	Código	8431488	Medida	Acabado				€uros
Caja	03031	030319	125x50mm	NS	-	1	40	
	03032	030326	125x50 mm	LTD	-	1	40	
Blister	17179	171791	125x50 mm	NS	1	-	8	
	17180	171807	125x50 mm	LTD	1	-	8	

Aluminio

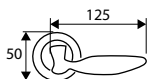

JGO ROSETA 353

	Código	8431488	Medida	Acabado				€uros
Caja	03531	035314	115x50 mm	CN	-	1	40	
Blister	17162	171623	115x50 mm	CN	1	-	8	

Aluminio

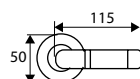

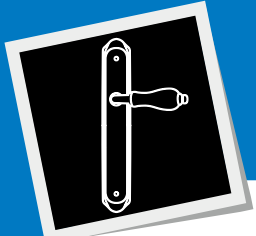

JGO ROSETA 484



	Código	8431488	Medida	Acabado				€uros
Caja	04841	048413	125x50 mm	NS	-	1	40	
	04842	048420	125x50 mm	LTD	-	1	40	
Blister	17174	171746	125x50 mm	NS	1	-	8	
	17175	171753	125x50 mm	LTD	1	-	8	

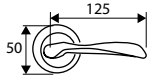

Aluminio
 NIQUEL SATINADO
 LATONADO

JGO ROSETA 909



	Código	8431488	Medida	Acabado				€uros
Caja	09091	090917	125x50 mm	LS	-	1	40	
	09092	090924	125x50 mm	NS	-	1	40	
Blister	17075	170756	125x50 mm	LS	1	-	8	
	17039	170398	125x50 mm	NS	1	-	8	

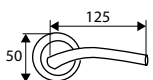

Aluminio
 LATÓN SATINADO
 NIQUEL SATINADO

JGO ROSETA 373



	Código	8431488	Medida	Acabado				€uros
Caja	03731	037318	125x50 mm	CN	-	1	40	
Blister	17164	171647	125x50 mm	CN	1	-	8	

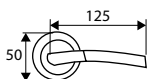

Aluminio
 CROMO BRILLO/
NIQUEL SATINADO

JGO ROSETA 404



	Código	8431488	Medida	Acabado				€uros
Caja	04041	040417	125x50 mm	LS	-	1	40	
	04042	040424	125x50 mm	NS	-	1	40	
Blister	17037	170374	125x50 mm	LS	1	-	8	
	17038	170381	125x50 mm	NS	1	-	8	

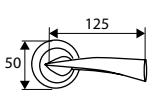

Aluminio
 LATÓN SATINADO
 NIQUEL SATINADO

JGO MANILLA S/PLACA 181

	Código	8431488	Medida	Acabado			€uros
Caja	01811	018119	110x30 mm	LTD	-	1	40
	01812	018126	110x30 mm	NS	-	1	40
	01813	018133	110x30 mm	CB	-	1	40
	01814	018140	110x30 mm	NE	-	1	40
	01815	018157	110x30 mm	BL	-	1	40
Blister	17231	172316	110x30 mm	LTD	1	-	8
	17232	172323	110x30 mm	NS	1	-	8
	17233	172330	110x30 mm	CB	1	-	8
	17234	172347	110x30 mm	NE	1	-	8
	17235	172354	110x30 mm	BL	1	-	8

Aluminio

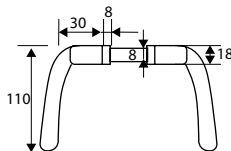

MANILLA CREMONA 414

	Código	8431488	Medida	Acabado			€uros
Caja	41401	414010	155x37 mm	LP	-	1	24
	41402	414027	155x37 mm	NS	-	1	24

Latón

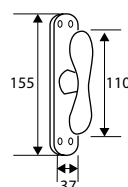

Incluye 5 pasadores

VARILLA CREMONA 1/2 CAÑA 414

	Código	8431488	Medida	Acabado			€uros
	41403	414034	1,5 mts	LP	-	2	-
	41404	414041	1,5 mts	NS	-	2	-

Latón



Macizo

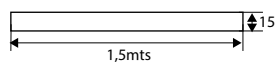

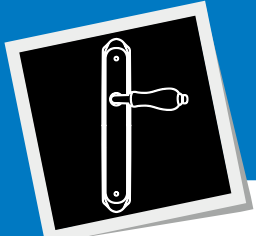

POMO PUERTA BOLA ENTRADA PP7



	Código	8431488	Picaporte	Acabado				€uros
Blister	11153	111537	60-70 mm	LP	1	-	6	
	11154	111544	60-70 mm	INOX	1	-	6	
	11161	111612	60-70 mm	BL	1	-	6	

Llave - Muletilla
Bloqueo y desbloqueo en ambos lados

LP/BL: Latón
INOX: Acero Inoxidable

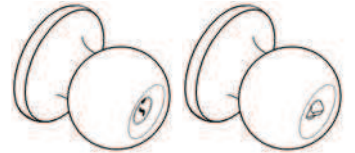
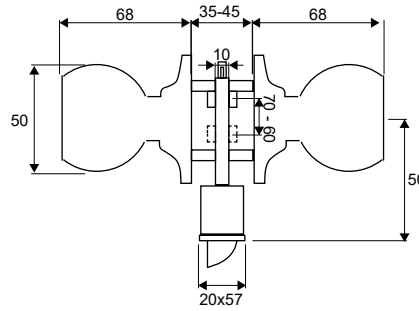

POMO PUERTA BOLA BAÑO PP7



	Código	8431488	Picaporte	Acabado				€uros
Blister	11155	111551	60-70 mm	LP	1	-	6	
	11156	111568	60-70 mm	INOX	1	-	6	
	11162	111629	60-70 mm	BL	1	-	6	

Desbloqueo - Condena
Interior con muletilla para bloqueo y exterior con desbloqueo de seguridad

LP/BL: Latón
INOX: Acero Inoxidable

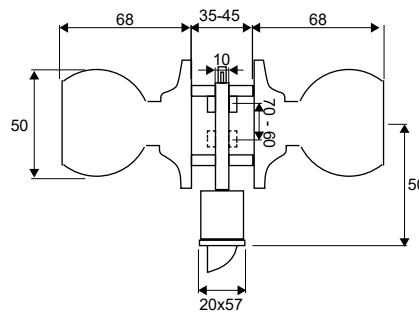

POMO PUERTA BOLA HOTEL PP7

	Código	8431488	Picaporte	Acabado				€uros
Blister	11157	111575	60-70 mm	LP	1	-	6	
	11158	111582	60-70 mm	INOX	1	-	6	
	11163	111636	60-70 mm	BL	1	-	6	

LP/BL: Latón
INOX: Acero Inoxidable

Llave - Libre

Apertura exterior con llave. Interior siempre libre

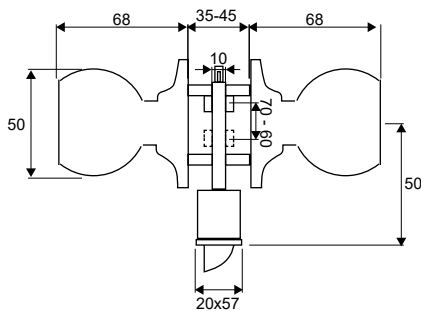
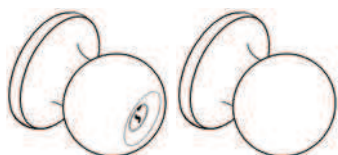

POMO PUERTA BOLA PASO PP7

	Código	8431488	Picaporte	Acabado				€uros
Blister	11159	111599	60-70 mm	LP	1	-	6	
	11160	111605	60-70 mm	INOX	1	-	6	
	11164	111643	60-70 mm	BL	1	-	6	

LP/BL: Latón
INOX: Acero Inoxidable

Libre - Libre

No se bloquea nunca

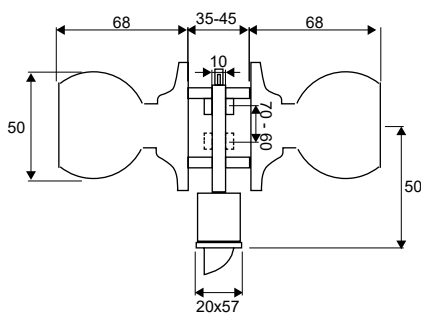

LLAVE BRUTO POMO PUERTA BOLA PP7

	Código	8431488	Medida	Acabado				€uros
Caja	11165	111650	200 mm	NI	-	50	500	

Latón



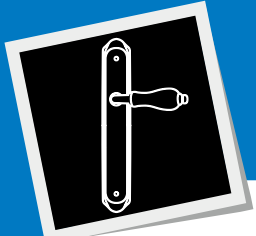

JGO MANILLA CORTAFUEGO C/BOCALLAVE 704



	Código	8431488	Medida	Acabado				€uros
Caja	00234	002347	168x44 mm	NE	-	1	20	
Blister	17139	171395	168x44 mm	NE	1	-	8	

Con bocallave de 72 mm

Acero/Nylon



NEGRO

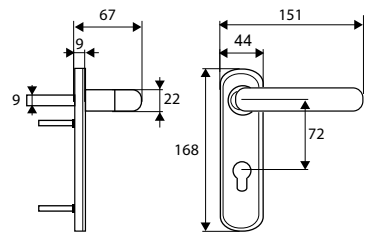

JGO MANILLA CORTAFUEGO CIEGA 704



	Código	8431488	Medida	Acabado				€uros
Caja	00235	002354	168x44 mm	NE	-	1	20	
Blister	17140	171401	168x44 mm	NE	1	-	8	

Ciega

Acero/Nylon



NEGRO

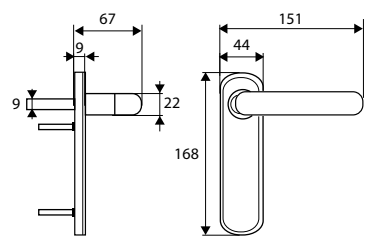

JGO MANILLA CORTAFUEGO C/POMO 704



	Código	8431488	Medida	Acabado				€uros
Caja	00236	002361	168x44 mm	NE	-	1	20	
Blister	17141	171418	168x44 mm	NE	1	-	8	

Con pomo y bocallave 72 mm

Acero/Nylon



NEGRO

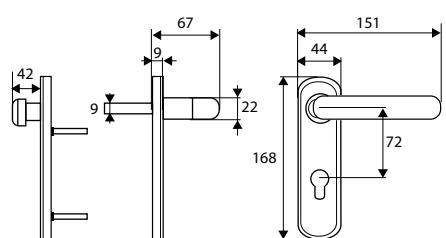

JGO MANILLA 703

	Código	8431488	Medida	Acabado				€uros
	00237	002378	130x60 mm	PL	-	1	6	
	00238	002385	130x60 mm	OR	-	1	6	
Blister	17152	171524	130x60 mm	PL	1	-	8	
	17153	171531	130x60 mm	OR	1	-	8	

Aluminio

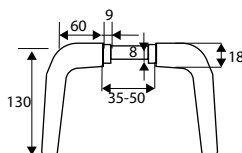

JGO MANILLA PUERTA METÁLICA 232

	Código	8431488	Medida A	Acabado				€uros
	00232	002323	25-38 mm	NE	-	1	10	
	00239	002392	35-50 mm	NE	-	1	12	
	00240	002408	45-60 mm	NE	-	1	12	
	00233	002330	25-38 mm	CB	-	1	12	
Blister	17124	171241	25-38 mm	NE	1	-	8	
	17137	171371	35-50 mm	NE	1	-	8	
	17138	171388	45-60 mm	NE	1	-	8	
	17125	171258	25-38 mm	CB	1	-	8	

Aluminio

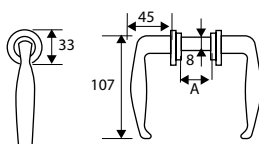

JGO MANILLA BASCULANTE 231

	Código	8431488	Medida	Acabado				€uros
	00231	002316	96x46 mm	NE	-	1	5	

Aluminio

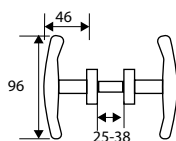

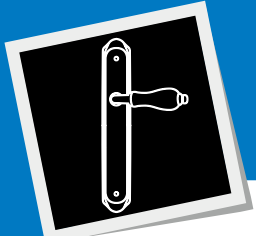

BOCALLAVE PERA 575



	Código	8431488	Medida	Acabado			€uros
Caja	09793	097930	53 mm	INOX	-	10	100
	97921	979212	53 mm	PVD	-	10	200
	97922	979229	53 mm	NE	-	10	200
	97923	979236	53 mm	BL	-	10	200
Blister	17060	170602	53 mm	INOX	1	-	10
	17266	172668	53 mm	PVD	1	-	10
	17267	172675	53 mm	NE	1	-	10
	17268	172682	53 mm	BL	1	-	10

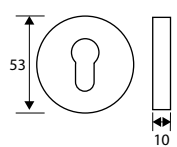

Acero Inoxidable

INOX
 PVD
 NEGRO
 BLANCO



BOCALLAVE PERA 545

	Código	8431488	Medida	Acabado			€uros
	97920	979205	54 mm	INOX	-	1	10
Blister	17156	171562	54 mm	INOX	1	-	10

Escudo a rosca

Acero Inoxidable

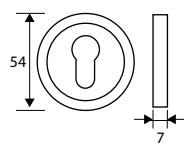

INOX



BOCALLAVE PERA 898

	Código	8431488	Medida	Acabado			€uros
	97925	979250	50 mm	NM	-	1	10
	97926	979267	50 mm	NN	-	1	10
Blister	17207	172071	50 mm	NM	1	-	10
	17208	172088	50 mm	NN	1	-	10

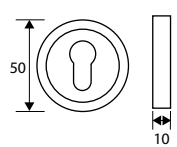

Zamak

NIQUEL MATE
 NEGRO SATINADO



BOCALLAVE PERA CUADRADO 848

	Código	8431488	Medida	Acabado			€uros
	97928	979281	50 mm	NM	-	1	10
	97929	979298	50 mm	NN	-	1	10
Blister	17210	172101	50 mm	NM	1	-	10
	17211	172118	50 mm	NN	1	-	10

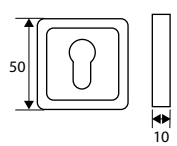

Zamak

NIQUEL MATE
 NEGRO SATINADO

BOCALLAVE PERA CUADRADO 131

	Código	8431488	Medida	Acabado				€uros
	97924	979243	53x53 mm	INOX	-	1	10	
<i>Blister</i>	17197	171975	53x53 mm	INOX	1	-	10	

Acero Inoxidable



INOX

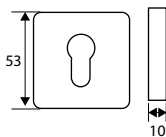

BOCALLAVE PERA 727

	Código	8431488	Medida	Acabado				€uros
	00979	009797	50 mm	LP	-	1	10	
	09792	097923	50 mm	NS	-	1	10	
	09795	097954	50 mm	CU	-	1	10	

Latón



LATÓN PULIDO



NIQUEL SATINADO



CUERO

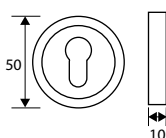

BOCALLAVE PERA 787

	Código	8431488	Medida	Acabado				€uros
	97915	979151	50 mm	CU	-	1	10	
	97917	979175	50 mm	LE	-	1	10	
	97919	979199	50 mm	PE	-	1	10	
<i>Blister</i>	17057	170572	50 mm	CU	1	-	10	
<i>Blister</i>	17058	170589	50 mm	LE	1	-	10	
<i>Blister</i>	17059	170596	50 mm	PE	1	-	10	

Zamak



CUERO



LATÓN ENVEJECIDO



PLATA ENVEJECIDA

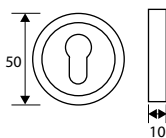

BOCALLAVE PERA 949

	Código	8431488	Medida	Acabado				€uros
	97927	979274	50 mm	CB	-	1	10	
<i>Blister</i>	17209	172095	50 mm	CB	1	-	10	

Zamak



CROMO BRILLO

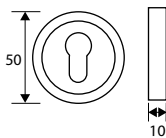

BOCALLAVE PERA 707

	Código	8431488	Medida	Acabado				€uros
<i>Caja</i>	97911	979113	50 mm	LTD	-	10	100	
	97912	979120	50 mm	LS	-	10	100	
	97916	979168	50 mm	NS	-	10	100	
<i>Blister</i>	17186	171869	50 mm	LTD	1	-	10	
	17055	170558	50 mm	LS	1	-	10	
	17056	170565	50 mm	NS	1	-	10	

Aluminio



LATONADO



LATÓN SATINADO



NIQUEL SATINADO

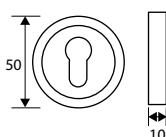

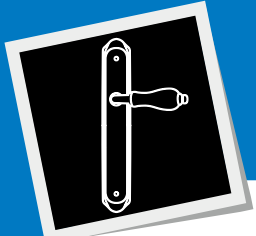

MULETILLA ROSETA 575



	Código	8431488	Medida A	Acabado				€uros
Caja	10962	109626	35 mm	INOX	-	1	10	
	10967	109671	35 mm	PVD	-	1	200	
	10968	109688	35 mm	NE	-	1	200	
	10969	109695	35 mm	BL	-	1	200	
	10953	109534	53 mm	INOX	-	1	10	
Blister	17067	170671	35 mm	INOX	1	-	10	
	17269	172699	35 mm	PVD	1	-	10	
	17270	172705	35 mm	NE	1	-	10	
	17271	172712	35 mm	BL	1	-	10	

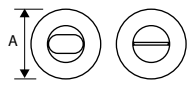

Acero Inoxidable
 INOX PVD NEGRO BLANCO

MULETILLA ROSETA 545

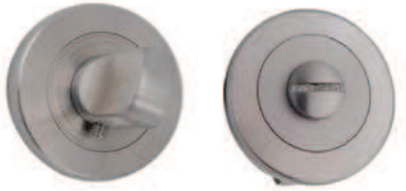

	Código	8431488	Medida	Acabado				€uros
	10966	109664	54 mm	INOX	-	1	10	
Blister	17155	171555	54 mm	INOX	1	-	10	

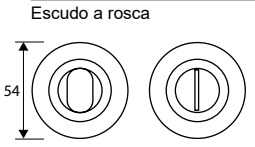

Escudo a rosca
 Acero Inoxidable
 INOX

MULETILLA ROSETA CUADRADA 131



	Código	8431488	Medida A	Acabado				€uros
	10970	109701	35 mm	INOX	-	1	10	
	10973	109732	53 mm	INOX	-	1	10	
Blister	17222	172224	35 mm	INOX	1	-	10	

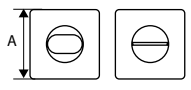

Acero Inoxidable
 INOX

MULETILLA ROSETA 727



	Código	8431488	Medida A	Acabado				€uros
	10096	100968	35 mm	LP	-	1	10	
	10961	109619	35 mm	NS	-	1	10	
	10963	109633	35 mm	CU	-	1	10	
	10952	109527	50 mm	NS	-	1	10	

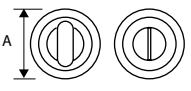

Latón
 LATÓN PULIDO NÍQUEL SATINADO CUERO

MULETILLA ROSETA 898 / 949



	Código	8431488	Medida	Acabado				€uros
	10974	109749	50 mm	NM	-	1	10	
	10975	109756	50 mm	NN	-	1	10	
	10978	109787	50 mm	CB	-	1	10	
Blister	17212	172125	50 mm	NM	1	-	10	
	17213	172132	50 mm	NN	1	-	10	
	17216	172163	50 mm	CB	1	-	10	

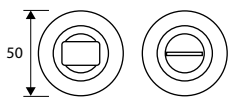

Zamak
 NÍQUEL MATE NEGRO SATINADO CROMO BRILLO

MULETILLA ROSETA CUADRADA 848

	Código	8431488	Medida	Acabado				€uros
	10976	109763	50 mm	NM	-	1	10	
	10977	109770	50 mm	NN	-	1	10	
Blister	17214	172149	50 mm	NM	1	-	10	
	17215	172156	50 mm	NN	1	-	10	

Zamak

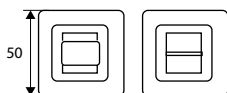

MULETILLA ROSETA 787

	Código	8431488	Medida	Acabado				€uros
	11965	119656	35 mm	CU	-	1	10	
	11967	119670	35 mm	LE	-	1	10	
	11969	119694	35 mm	PE	-	1	10	
Blister	17064	170640	35 mm	CU	1	-	10	
	17065	170657	35 mm	LE	1	-	10	
	17066	170664	35 mm	PE	1	-	10	

Zamak



MULETILLA ROSETA 707

	Código	8431488	Medida	Acabado				€uros
Caja	11961	119618	35 mm	LTD	-	10	100	
	11962	119625	35 mm	LS	-	10	100	
	11966	119663	35 mm	NS	-	10	100	
Blister	17185	171852	35 mm	LTD	1	-	10	
	17061	170619	35 mm	LS	1	-	10	
	17062	170626	35 mm	NS	1	-	10	

Aluminio

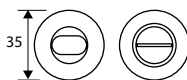

MULETILLA ROSETA 707

	Código	8431488	Medida	Acabado				€uros
Caja	11960	119601	35 mm	NS	-	10	100	

Aluminio - Interior Nylon

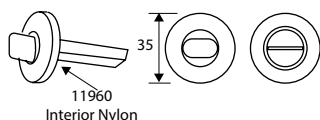

MULETILLA ROSETA CUADRADA 616

	Código	8431488	Medida	Acabado				€uros
	83839	838397	35 mm	NS	-	1	10	
Blister	17136	171364	35 mm	NS	1	-	10	

Aluminio



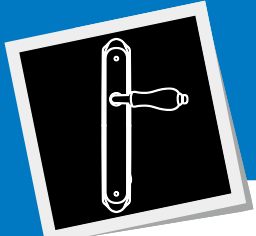

MULETILLA ROSETA C/LLAVE 1095



	Código	8431488	Medida /Canto	Acabado				€uros
Caja	10957	109572	50 mm/Redonda	NS	-	1	50	
	10959	109596	50 mm/Redonda	LTD	-	1	50	
	10958	109589	50 mm/Cuadrada	NS	-	1	50	
	10960	109602	50 mm/Cuadrada	LTD	-	1	50	

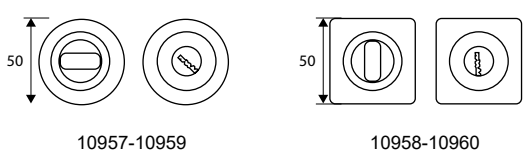

Zamak
 LATONADO
 NIQUEL SATINADO

MULETILLA MANILLA C/DESBLOQUEO 1098

	Código	8431488	Medida	Acabado				€uros
Caja	1098	100982	6 mm	LP	-	25	250	
	10982	109824	6 mm	NS	-	25	250	
	10981	109817	6 mm	CU	-	1	10	
	10987	119879	6 mm	LE	-	1	10	
	11988	119885	6 mm	NE	-	1	10	
	11987	119878	6 mm	BL	-	1	10	
	Blister	17069	170695	6 mm	LP	1	-	10
17071		170718	6 mm	NS	1	-	10	
17070		170701	6 mm	CU	1	-	10	
17072		170725	6 mm	LE	1	-	10	
17073		170732	6 mm	NE	1	-	10	
17236		172361	6 mm	BL	1	-	10	

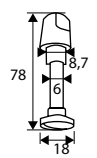

Zamak
 LATÓN PULIDO
 NIQUEL SATINADO
 CUERO
 LATÓN ENVEJECIDO
 NEGRO
 BLANCO

MULETILLA MANILLA 10014



	Código	8431488	Tipo	Acabado				€uros
Caja	10014	100142	6 mm	LP	-	25	250	
	10143	101439	6 mm	NS	-	25	250	
Blister	91818	918181	6 mm	LP	1	-	10	
	91819	918198	6 mm	NS	1	-	10	

Incluye grupilla

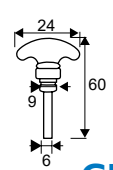

Latón
 LATÓN PULIDO
 NIQUEL SATINADO

GRUPILLA MULETILLA PRESIÓN 1014



	Código	8431488	Medida	Acabado				€uros
Caja	00001	000015	17 mm	NE	-	100	-	

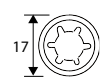

Acero
 NEGRO



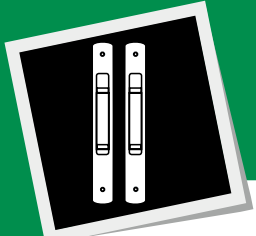

JGO MANILLA 6800

	Código	8431488	Medida	Acabado				€uros
	68000	680002	130 mm	BL	-	1	10	
	68001	680019	130 mm	NE	-	1	10	
	68002	680026	130 mm	PL	-	1	10	
<i>Blister</i>	17080	170800	130 mm	BL	1	-	8	
	17081	170817	130 mm	NE	1	-	8	
	17082	170824	130 mm	PL	1	-	8	

2 taladros

Aluminio

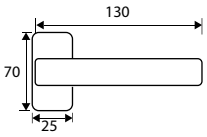

JGO MANILLA 6802

	Código	8431488	Medida	Acabado				€uros
	68009	680095	120 mm	BL	-	1	4	
	68010	680101	120 mm	NE	-	1	4	
	68011	680118	120 mm	PL	-	1	4	
<i>Blister</i>	17083	170831	120 mm	BL	1	-	8	
	17084	170848	120 mm	NE	1	-	8	
	17085	170855	120 mm	PL	1	-	8	

2 taladros

Aluminio

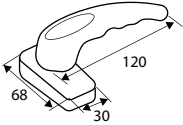

JGO MANILLA 6842

	Código	8431488	Medida	Acabado				€uros
	68270	682709	120 mm	BL	-	1	4	
	68271	682716	120 mm	NE	-	1	4	
	68272	682723	120 mm	PL	-	1	4	
<i>Blister</i>	17275	172750	120 mm	BL	1	-	8	
	17276	172767	120 mm	NE	1	-	8	
	17277	172774	120 mm	PL	1	-	8	

1 taladro

Aluminio

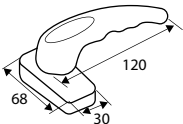

JGO MANILLA 6827

	Código	8431488	Medida	Acabado				€uros
	68138	681382	125 mm	BL	-	1	4	
	68139	681399	125 mm	NE	-	1	4	
	68140	681405	125 mm	PL	-	1	4	
Blister	17142	171425	125 mm	BL	1	-	8	
	17143	171432	125 mm	NE	1	-	8	
	17144	171449	125 mm	PL	1	-	8	

Aluminio

2 taladros

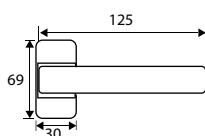

JGO MANILLA 6846

	Código	8431488	Medida	Acabado				€uros
	68189	681894	115 mm	BL	-	1	4	
	68190	681900	115 mm	NE	-	1	4	
	68191	681917	115 mm	PL	-	1	4	
Blister	17145	171456	115 mm	BL	1	-	8	
	17146	171463	115 mm	NE	1	-	8	
	17147	171470	115 mm	PL	1	-	8	

Aluminio

2 taladros

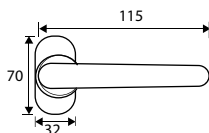

JGO MANILLA 702

	Código	8431488	Medida	Acabado				€uros
	68122	681221	120 mm	BL	-	1	5	
	68123	681238	120 mm	NE	-	1	5	
	68124	681245	120 mm	PL	-	1	5	
Blister	17098	170985	120 mm	BL	1	-	8	
	17099	170992	120 mm	NE	1	-	8	
	17100	171005	120 mm	PL	1	-	8	

Aluminio

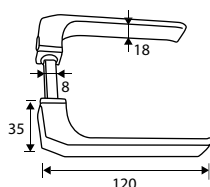

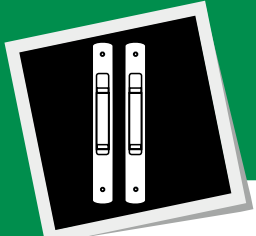

CIERRE PRESIÓN 6801



Código	8431488	Mano	Acabado				€uros
68003	680033	derecha	BL	-	1	10	
68004	680040	izquierda	BL	-	1	10	
68005	680057	derecha	NE	-	1	10	
68006	680064	izquierda	NE	-	1	10	
68007	680071	derecha	PL	-	1	10	
68008	680088	izquierda	PL	-	1	10	
<i>Blister</i>	17086	170862	derecha	BL	1	-	8
	17087	170879	izquierda	BL	1	-	8
	17088	170886	derecha	NE	1	-	8
	17089	170893	izquierda	NE	1	-	8
	17090	170909	derecha	PL	1	-	8
17091	170916	izquierda	PL	1	-	8	

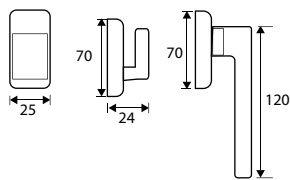

Aluminio

BLANCO NEGRO PLATA

CIERRE PRESIÓN 6858 (LLAVES IGUALES)



Código	8431488	Mano	Acabado				€uros
68312	683126	derecha	BL	-	1	4	
68313	683133	izquierda	BL	-	1	4	
68314	683140	derecha	NE	-	1	4	
68315	683157	izquierda	NE	-	1	4	
<i>Blister</i>	17284	172842	derecha	BL	1	-	8
	17285	172859	izquierda	BL	1	-	8
	17286	172866	derecha	NE	1	-	8
	17287	172873	izquierda	NE	1	-	8

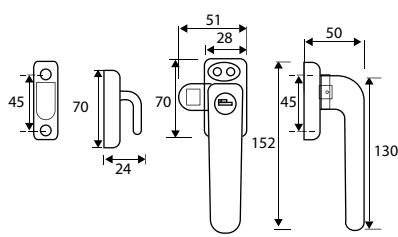

Aluminio

BLANCO NEGRO PLATA

CIERRE PRESIÓN 6864



Código	8431488	Mano	Acabado				€uros
68328	683287	derecha	PL	-	1	4	
68329	683294	izquierda	PL	-	1	4	
<i>Blister</i>	17288	172880	derecha	PL	1	-	8
	17289	172897	izquierda	PL	1	-	8

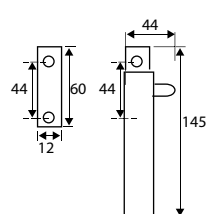

Aluminio

PLATA

ALUMINIO



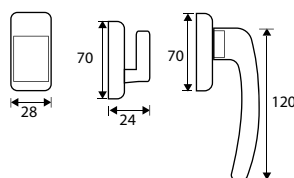

CIERRE PRESIÓN 6805

	Código	8431488	Mano	Acabado				€uros
	68045	680453	derecha	BL	-	1	4	
	68046	680460	izquierda	BL	-	1	4	
	68047	680477	derecha	NE	-	1	4	
	68048	680484	izquierda	NE	-	1	4	
	68049	680491	derecha	PL	-	1	4	
	68050	680507	izquierda	PL	-	1	4	
<i>Blister</i>	17092	170923	derecha	BL	1	-	8	
	17093	170930	izquierda	BL	1	-	8	
	17094	170947	derecha	NE	1	-	8	
	17095	170954	izquierda	NE	1	-	8	
	17096	170961	derecha	PL	1	-	8	
	17097	170978	izquierda	PL	1	-	8	

Aluminio





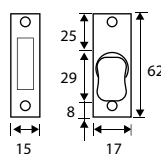

CIERRE PRESIÓN 6857

	Código	8431488	Medida	Acabado				€uros
	68304	683041	62x17 mm	BL	-	1	5	
	68305	683058	62x17 mm	NE	-	1	5	
<i>Blister</i>	92296	922966	62x17 mm	BL	1	-	10	
	92297	922973	62x17 mm	NE	1	-	10	

Aluminio



CIERRE CONTRAVENTANA 6840

	Código	8431488	Medida	Acabado				€uros
	68177	681771	84x25 mm	BL	-	1	5	
	68178	681788	84x25 mm	NE	-	1	5	
<i>Blister</i>	91932	919324	84x25 mm	BL	1	-	10	
	91933	919331	84x25 mm	NE	1	-	10	

Aluminio

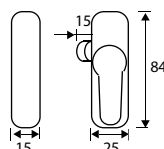

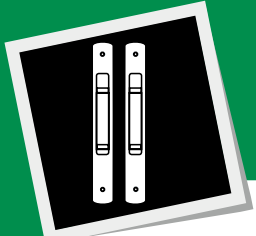

JGO MANILLA CIEGA 6824

	Código	843 I 488	Medida	Acabado				€uros
Caja	68306	683065	225x30 mm	BL	-	1	10	
	68307	683072	225x30 mm	NE	-	1	10	
Blister	17278	172781	225x30 mm	BL	1	-	8	
	17279	172798	225x30 mm	NE	1	-	8	

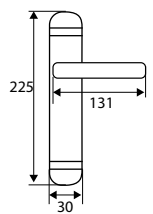

Aluminio



JGO MANILLA C/BOCALLAVE 6824

	Código	843 I 488	Medida	Acabado				€uros
Caja	68069	680699	225x30 mm	BL	-	1	10	
	68070	680705	225x30 mm	NE	-	1	10	
Blister	17101	171012	225x30 mm	BL	1	-	8	
	17102	171029	225x30 mm	NE	1	-	8	

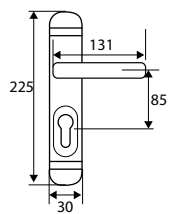

Aluminio



ASA PLACA CIEGA 6843

	Código	843 I 488	Medida	Acabado				€uros
	68308	683089	225x30 mm	BL	-	1	2	
	68309	683096	225x30 mm	NE	-	1	2	
Blister	17280	172804	225x30 mm	BL	2	-	8	
	17281	172811	225x30 mm	NE	2	-	8	

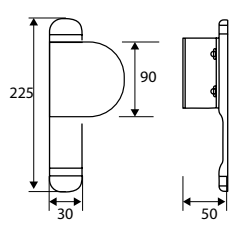

Precio unitario

Aluminio



ALUMINIO

ASA PLACA C/BOCALLAVE 6843

	Código	8431488	Medida	Acabado				€uros
	68183	681832	225x30 mm	BL	-	1	2	
	68184	681849	225x30 mm	NE	-	1	2	
Blister	17150	171500	225x30 mm	BL	2	-	8	
	17151	171517	225x30 mm	NE	2	-	8	

Aluminio

Precio unitario

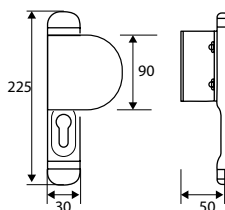

JGO POMO PLACA CIEGA 6844

	Código	8431488	Medida	Acabado				€uros
Caja	68310	683102	225x30 mm	BL	-	1	10	
	68311	683119	225x30 mm	NE	-	1	10	
Blister	17282	172828	225x30 mm	BL	1	-	8	
	17283	172835	225x30 mm	NE	1	-	8	

Aluminio

Precio juego (2 uds)

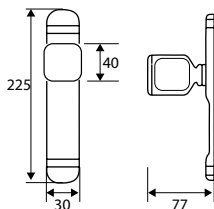

JGO POMO PLACA C/BOCALLAVE 6844

	Código	8431488	Medida	Acabado				€uros
Caja	68185	681856	225x30 mm	BL	-	1	10	
	68186	681863	225x30 mm	NE	-	1	10	
Blister	17148	171487	225x30 mm	BL	1	-	8	
	17149	171494	225x30 mm	NE	1	-	8	

Aluminio

Precio juego (2 uds)

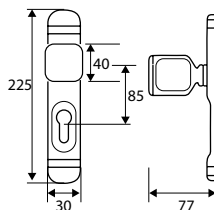

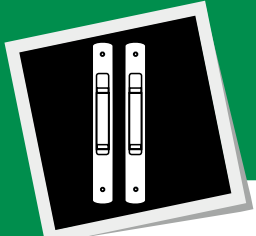

JGO POMO RECUPERABLE 6807



Código	8431488	Medida	Acabado				€uros
	68012	680125	80x39 mm	BL	-	1	10
	68013	680132	80x39 mm	NE	-	1	10
	68014	680149	80x39 mm	PL	-	1	10
Blíster	17103	171036	80x39 mm	BL	1	-	8
	17104	171043	80x39 mm	NE	1	-	8
	17105	171050	80x39 mm	PL	1	-	8

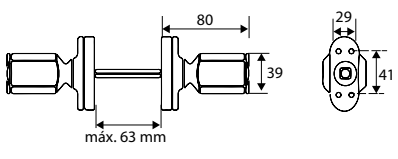

Aluminio

BLANCO
 NEGRO
 PLATA

ASA PLACA RECTA 6804



Código	8431488	Medida	Acabado				€uros
	68018	680187	200 mm	BL	-	1	5
	68019	680194	200 mm	NE	-	1	5
	68020	680200	200 mm	PL	-	1	5
Blíster	17106	171067	200 mm	BL	2	-	8
	17107	171074	200 mm	NE	2	-	8
	17108	171081	200 mm	PL	2	-	8

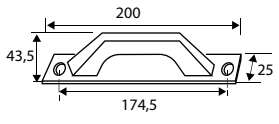

Aluminio

BLANCO
 NEGRO
 PLATA

ASA RECTA S/PLACA 6804



Código	8431488	Medida	Acabado				€uros
	68279	682792	152 mm	BL	-	1	5
	68280	682808	152 mm	NE	-	1	5
	68281	682815	152 mm	PL	-	1	5
Blíster	92281	922812	152 mm	BL	1	-	10
	92282	922829	152 mm	NE	1	-	10
	92283	922836	152 mm	PL	1	-	10

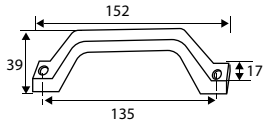

Aluminio

BLANCO
 NEGRO
 PLATA

ASA PLACA REDONDA 6803

	Código	8431488	Medida	Acabado				€uros
	68015	680156	200 mm	BL	-	1	5	
	68016	680163	200 mm	NE	-	1	5	
	68017	680170	200 mm	PL	-	1	5	
<i>Blister</i>	17109	171098	200 mm	BL	2	-	8	
	17110	171104	200 mm	NE	2	-	8	
	17111	171111	200 mm	PL	2	-	8	

Aluminio

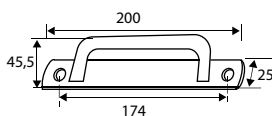

ASA CORREDERA 6809

	Código	8431488	Medida	Acabado				€uros
	68024	680248	173 mm	BL	-	1	5	
	68025	680255	173 mm	NE	-	1	5	
	68026	680262	173 mm	PL	-	1	5	
<i>Blister</i>	17292	172927	173 mm	BL	1	-	10	
	17293	172934	173 mm	NE	1	-	10	
	17294	172941	173 mm	PL	1	-	10	

Aluminio

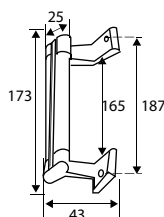

ASA CORREDERA 6862

	Código	8431488	Medida	Acabado				€uros
	68297	682976	97 mm	BL	-	1	5	
	68298	682983	97 mm	NE	-	1	5	
	68299	682990	97 mm	PL	-	1	5	

Aluminio

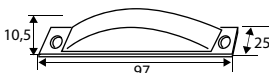

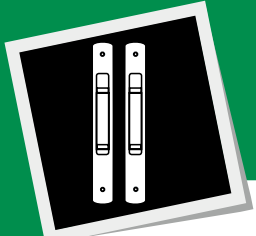

ASA CIERRE OVAL 6849

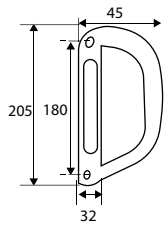

Código	8431488	Medida	Acabado				€uros
	68275	682754	205 mm	BL	-	1	5
	68276	682761	205 mm	NE	-	1	5
	68341	683416	205 mm	PL	-	1	5

Aluminio
 BLANCO
 NEGRO
 PLATA

CIERRE CORREDERA 6820

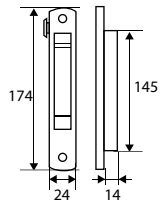

Código	8431488	Medida	Acabado				€uros
	68061	680613	174x24 mm	BL	-	2	10
	68062	680620	174x24 mm	NE	-	2	10
<i>Blister</i>	91802	918020	174x24 mm	BL	2	-	10
	91803	918037	174x24 mm	NE	2	-	10

Aluminio
 BLANCO
 NEGRO

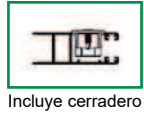

CIERRE CORREDERA 6845

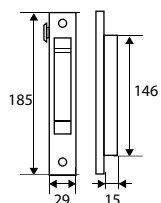

Código	8431488	Medida	Acabado				€uros
	68187	681870	185x29 mm	BL	-	2	10
	68188	681887	185x29 mm	NE	-	2	10
<i>Blister</i>	91966	919669	185x29 mm	BL	2	-	10
	91967	919676	185x29 mm	NE	2	-	10

Aluminio
 BLANCO
 NEGRO

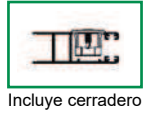

CIERRE CORREDERA 6821

	Código	8431488	Medida	Acabado				€uros
	68063	680637	174x24 mm	BL	-	2	10	
	68064	680644	174x24 mm	NE	-	2	10	
Blister	91804	918044	174x24 mm	BL	2	-	10	
	91805	918051	174x24 mm	NE	2	-	10	

Aluminio

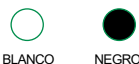

BLANCO NEGRO



Incluye cerradero

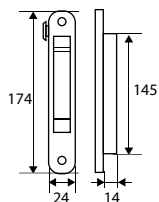

CIERRE CORREDERA 6822

	Código	8431488	Medida	Acabado				€uros
	68065	680651	174x24 mm	BL	-	2	10	
	68066	680668	174x24 mm	NE	-	2	10	
Blister	91806	918068	174x24 mm	BL	2	-	10	
	91807	918075	174x24 mm	NE	2	-	10	

Aluminio



BLANCO NEGRO

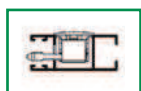

Incluye cerradero

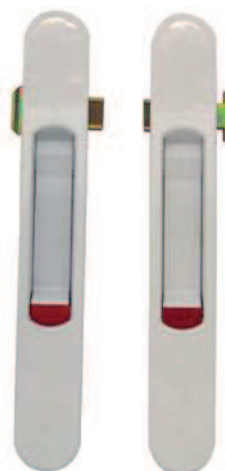
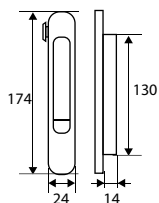

CIERRE CORREDERA 6823

	Código	8431488	Medida	Acabado				€uros
	68067	680675	167x24 mm	BL	-	2	10	
	68068	680682	167x24 mm	NE	-	2	10	
Blister	91808	918082	167x24 mm	BL	2	-	10	
	91809	918099	167x24 mm	NE	2	-	10	

Aluminio



BLANCO NEGRO



Incluye cerradero

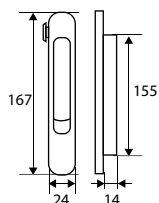

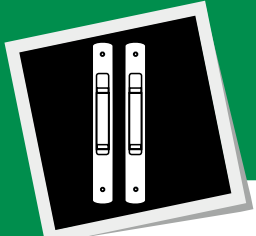

CIERRE CORREDERA PLÁSTICO 6836



	Código	8431488	Medida	Acabado				€uros
	68163	681634	165x26 mm	BL	-	2	10	
	68164	681641	165x26 mm	NE	-	2	10	
<i>Blister</i>	91958	919584	165x26 mm	BL	2	-	10	
	91959	919591	165x26 mm	NE	2	-	10	

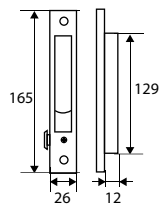

Nylon
 BLANCO
 NEGRO

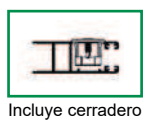

CIERRE CORREDERA 6859 (LLAVES IGUALES)



	Código	8431488	Medida	Acabado				€uros
	68316	683164	206x25 mm	BL	-	1	5	
	68317	683171	206x25 mm	NE	-	1	5	
<i>Blister</i>	92298	922980	206x25 mm	BL	2	-	10	
	92299	922997	206x25 mm	NE	2	-	10	

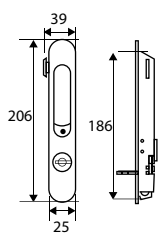

Aluminio
 BLANCO
 NEGRO

CIERRE CORREDERA 6826 (LLAVES IGUALES)



	Código	8431488	Medida	Acabado				€uros
	68135	681351	120x29 mm	BL	-	1	5	
	68136	681368	120x29 mm	NE	-	1	5	
<i>Blister</i>	92169	921693	120x29 mm	BL	1	-	10	
	92170	921709	120x29 mm	NE	1	-	10	

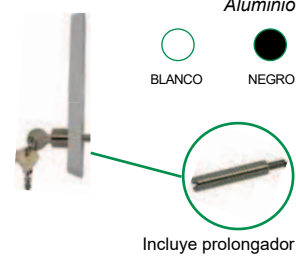
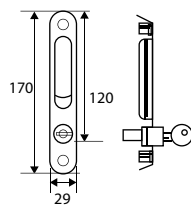

Aluminio
 BLANCO
 NEGRO

PROLONGADOR CIERRE CORREDERA 6826



	Código	8431488	Medida	Acabado				€uros
Caja	68137	681375	36 mm	NI	-	10	250	

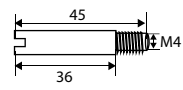

Acero
 NIQUEL

CERRADERO LENGÜETA 6818

	Código	8431488	Tipo	Acabado			€uros
Caja	68032	680323	abierto	ZN	-	25	625
	68071	680712	doble desplazamiento	ZN	-	25	625
	68059	680590	30x20 mm	ZN	-	25	625
	68060	680606	36x20 mm	ZN	-	25	625
Blister	91964	919645	abierto	ZN	2	-	10
	91965	919652	doble desplazamiento	ZN	2	-	10
	91487	914879	30x20 mm	ZN	2	-	10
	91488	914886	36x20 mm	ZN	2	-	10

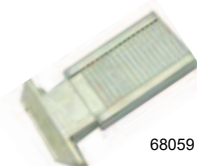

KIT CERRADERO LENGÜETA 6818

	Código	8431488	Acabado				€uros
Blister	92280	922805	ZN	4	-	10	3,9500

Zamak



Incluye:

- 1 ud - 68059 -CERRADERO LENGÜETA 6818-22 ZN
- 1 ud - 68060 -CERRADERO LENGÜETA 6818-25 ZN
- 1 ud - 68032 -CERRADERO LENGÜETA 6818-01 ZN
- 1 ud - 68071 -CERRADERO LENGÜETA 6818-02 ZN

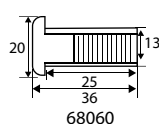
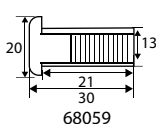
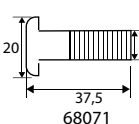
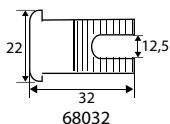

CONTRACIERRE 6819

	Código	8431488	Medida	Acabado			€uros
Caja	68128	681283	32 mm	ZN	-	25	625
	68129	681290	54 mm	ZN	-	25	250
	68130	681306	30 mm	ZN	-	25	625
	68131	681313	35 mm	BC	-	25	625
	68165	681658	38,9x11,9 mm	NE	-	25	625
	68166	681665	33x8,5 mm	ZN	-	25	625
	68167	681672	49,5x7x6 mm	ZN	-	25	625
	68168	681689	49,5x7x8 mm	ZN	-	25	625
Blister	91483	914831	32 mm	ZN	2	-	10
	91484	914848	54 mm	ZN	2	-	10
	91485	914855	30 mm	ZN	2	-	10
	91486	914862	35 mm	BC	2	-	10
	91960	919607	38,9x11,9 mm	NE	2	-	10
	91961	919614	33x8,5 mm	ZN	2	-	10
	91962	919621	49,5x7x6 mm	ZN	2	-	10
	91963	919638	49,5x7x8 mm	ZN	2	-	10



KIT CONTRACIERRE 6819

	Código	8431488	Acabado				€uros
Blister	92279	922799	BC/ZN	4	-	10	3,6500

Zamak



Incluye:

- 1 ud - 68128 -CONTRACIERRE 6819-01 ZN
- 1 ud - 68129 -CONTRACIERRE 6819-02 ZN
- 1 ud - 68130 -CONTRACIERRE 6819-05 ZN
- 1 ud - 68131 -CONTRACIERRE 6819-12 BC

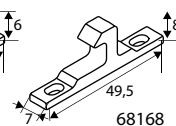
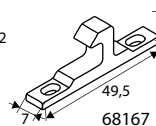
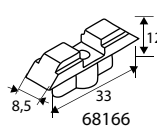
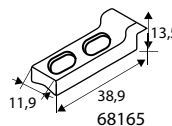
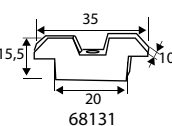
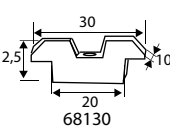
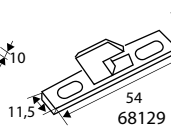
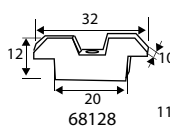

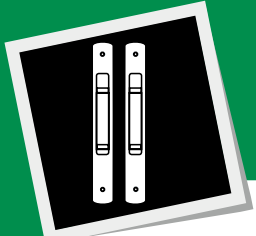

CIERRE CORREDERA PULSAR 6841



	Código	8431488	Medida	Acabado				€uros
	68179	681795	172x19 mm	BL	-	1	5	
	68180	681801	172x19 mm	NE	-	1	5	
Blister	92129	921297	172x19 mm	BL	1	-	10	
	91937	919379	172x19 mm	NE	1	-	10	

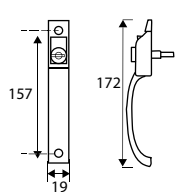

Aluminio
 BLANCO
 NEGRO

CIERRE CORREDERA 6841 (LLAVES IGUALES)



	Código	8431488	Medida	Acabado				€uros
	68181	681818	172x19 mm	BL	-	1	5	
	68182	681825	172x19 mm	NE	-	1	5	
Blister	91938	919386	172x19 mm	BL	1	-	10	
	91939	919393	172x19 mm	NE	1	-	10	

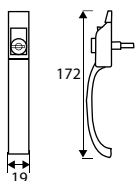

Aluminio
 BLANCO
 NEGRO

CIERRE CORREDERA 6847 (LLAVES IGUALES)



	Código	8431488	Medida	Acabado				€uros
	68192	681924	147x26 mm	BL	-	1	5	
	68193	681931	147x26 mm	NE	-	1	5	
Blister	91934	919348	147x26 mm	BL	1	-	10	
	91935	919355	147x26 mm	NE	1	-	10	

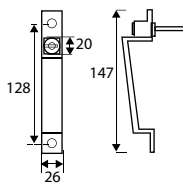

Aluminio
 BLANCO
 NEGRO

CIERRE CORREDERA PULSAR 6865



	Código	8431488	Medida	Acabado				€uros
	68330	683300	135x17 mm	BL	-	1	5	
	68331	683317	135x17 mm	NE	-	1	5	
	68332	683324	135x17 mm	PL	-	1	5	
Blister	92327	923277	135x17 mm	BL	1	-	10	
	92328	923284	135x17 mm	NE	1	-	10	
	92329	923291	135x17 mm	PL	1	-	10	

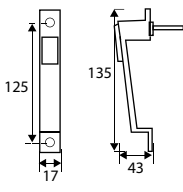

Aluminio
 BLANCO
 NEGRO
 PLATA

BISAGRA SERIE EUROPEA 6812

	Código	8431488	Mano	Acabado				€uros
	68033	680330	derecha	BL	-	2	10	
	68034	680347	izquierda	BL	-	2	10	
	68035	680354	derecha	NE	-	2	10	
	68036	680361	izquierda	NE	-	2	10	
	68037	680378	derecha	PL	-	2	10	
	68038	680385	izquierda	PL	-	2	10	
Blister	91471	914718	derecha	BL	2	-	10	
	91472	914725	izquierda	BL	2	-	10	
	91473	914732	derecha	NE	2	-	10	
	91474	914749	izquierda	NE	2	-	10	
	91475	914756	derecha	PL	2	-	10	
	91476	914763	izquierda	PL	2	-	10	

Aluminio

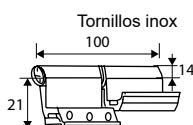

BISAGRA SERIE 40/20 6813

	Código	8431488	Mano	Acabado				€uros
	68039	680392	derecha	BL	-	2	10	
	68040	680408	izquierda	BL	-	2	10	
	68041	680415	derecha	NE	-	2	10	
	68042	680422	izquierda	NE	-	2	10	
	68043	680439	derecha	PL	-	2	10	
	68044	680446	izquierda	PL	-	2	10	
Blister	91477	914770	derecha	BL	2	-	10	
	91478	914787	izquierda	BL	2	-	10	
	91479	914794	derecha	NE	2	-	10	
	91480	914800	izquierda	NE	2	-	10	
	91481	914817	derecha	PL	2	-	10	
	91482	914824	izquierda	PL	2	-	10	

Aluminio

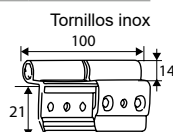

BISAGRA SERIE 40/20 6813

BISAGRA 3 NUDOS SERIE EUROPEA 6868

	Código	8431488	Medida	Acabado				€uros
	68342	683423	100x25 mm	BL	-	1	10	
	68343	683430	100x25 mm	NE	-	1	10	

Aluminio

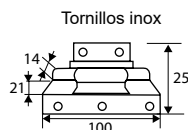

BISAGRA 3 NUDOS SERIE EUROPEA 6868

BISAGRA 3 CUERPOS SERIE 40/20 6867

	Código	8431488	Medida	Acabado				€uros
	68277	682778	150x45 mm	BL	-	1	5	
	68278	682785	150x45 mm	NE	-	1	5	

Aluminio

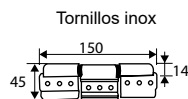

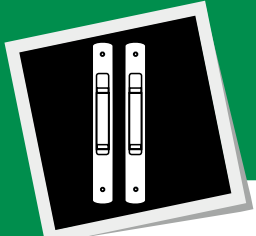

MANILLA MULTIPUNTO 6806

Código	843 I 488	Medida	Acabado				€uros
68030	680309	140x30 mm	BL	-	1	4	
68031	680316	140x30 mm	NE	-	1	4	

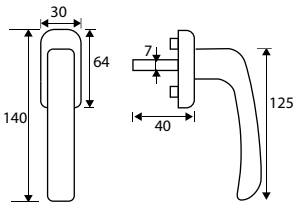

Aluminio



MANILLA MULTIPUNTO 6806 (LLAVES IGUALES)

Código	843 I 488	Medida	Acabado				€uros
68273	682730	150x30 mm	BL	-	1	4	
68274	682747	150x30 mm	NE	-	1	4	

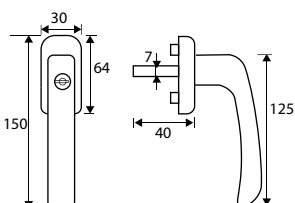

Aluminio



MANILLA MULTIPUNTO 6855

Código	843 I 488	Medida	Acabado				€uros
68300	683003	200x30 mm	BL	-	1	4	
68301	683010	200x30 mm	NE	-	1	4	

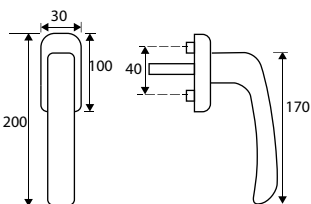

Aluminio



MANILLA FACHADA 6848

Código	843 I 488	Mano	Acabado				€uros
68194	681948	derecha	BL	-	1	4	
68195	681955	izquierda	BL	-	1	4	
68196	681962	derecha	NE	-	1	4	
68197	681979	izquierda	NE	-	1	4	
68198	681986	derecha	PL	-	1	4	
68199	681993	izquierda	PL	-	1	4	

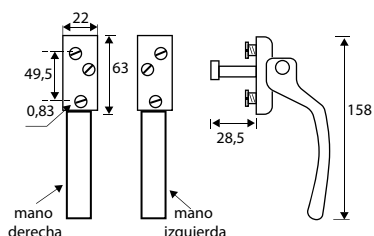

Aluminio



CREMONA 6816

	Código	8431488	Medida	Acabado				€uros
	68055	680552	170,5x25 mm	BL	-	1	5	
	68056	680569	170,5x25 mm	NE	-	1	5	
Blister	91814	918143	170,5x25 mm	BL	1	-	10	
	91815	918150	170,5x25 mm	NE	1	-	10	

Aluminio

2 patillas

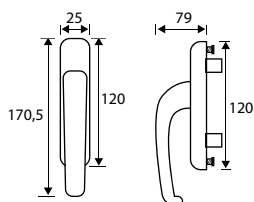

CREMONA 6817

	Código	8431488	Medida	Acabado				€uros
	68057	680576	180x34 mm	BL	-	1	5	
	68058	680583	180x34 mm	NE	-	1	5	
Blister	91816	918167	180x34 mm	BL	1	-	10	
	91817	918174	180x34 mm	NE	1	-	10	

Aluminio

2 patillas

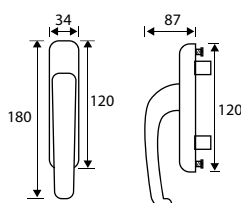

CREMONA 6814

	Código	8431488	Medida	Acabado				€uros
	68051	680514	160x29 mm	BL	-	1	5	
	68052	680521	160x29 mm	NE	-	1	5	
Blister	91810	918105	160x29 mm	BL	1	-	10	
	91811	918112	160x29 mm	NE	1	-	10	

Aluminio

2 patillas

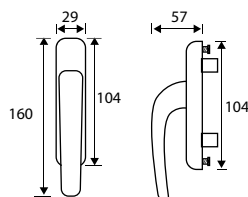

CREMONA 6815

	Código	8431488	Medida	Acabado				€uros
	68053	680538	173,5x34 mm	BL	-	1	5	
	68054	680545	173,5x34 mm	NE	-	1	5	
Blister	91812	918129	173,5x34 mm	BL	1	-	10	
	91813	918136	173,5x34 mm	NE	1	-	10	

Aluminio

2 patillas

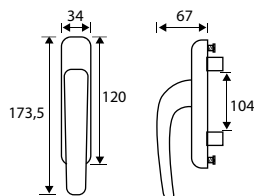

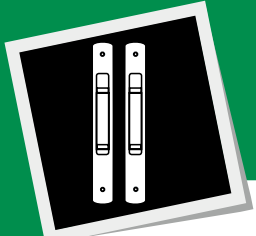

CREMONA 6828

	Código	8431488	Medida	Acabado				€uros
	68141	681412	130x35 mm	BL	-	1	5	
	68142	681429	130x35 mm	NE	-	1	5	
Blister	91940	919409	130x35 mm	BL	1	-	10	
	91941	919416	130x35 mm	NE	1	-	10	

1 Patilla

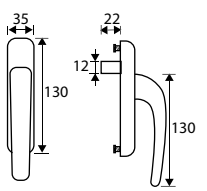

Aluminio
 BLANCO
 NEGRO

CREMONA 6829

	Código	8431488	Medida	Acabado				€uros
	68143	681436	130x35 mm	BL	-	1	5	
	68144	681443	130x35 mm	NE	-	1	5	
	68340	683409	130x35 mm	PL	-	1	5	
Blister	91942	919423	130x35 mm	BL	1	-	10	
	91943	919430	130x35 mm	NE	1	-	10	
	92380	923802	130x35 mm	PL	1	-	10	

2 Patillas

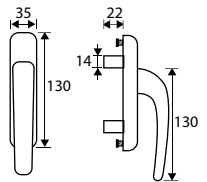

Aluminio
 BLANCO
 NEGRO
 PLATA

CREMONA 6830 (LLAVES IGUALES)

	Código	8431488	Medida	Acabado				€uros
	68145	681450	137x31 mm	BL	-	1	5	
	68146	681467	137x31 mm	NE	-	1	5	
Blister	91944	919447	137x31 mm	BL	1	-	10	
	91945	919454	137x31 mm	NE	1	-	10	

2 Patillas con llave

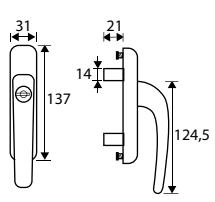

Aluminio
 BLANCO
 NEGRO

CREMONA 6831

	Código	8431488	Medida	Acabado				€uros
	68147	681474	130x35 mm	BL	-	1	5	
	68148	681481	130x35 mm	NE	-	1	5	
Blister	92130	921303	130x35 mm	BL	1	-	10	
	91947	919478	130x35 mm	NE	1	-	10	

Patilla "U"

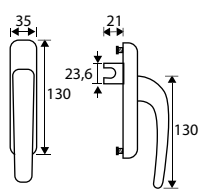

Aluminio
 BLANCO
 NEGRO

CREMONA 6832

	Código	8431488	Medida	Acabado				€uros
	68149	681498	130x35 mm	BL	-	1	5	
	68150	681504	130x35 mm	NE	-	1	5	
Blister	91952	919522	130x35 mm	BL	1	-	10	
	91953	919539	130x35 mm	NE	1	-	10	

Aluminio



Patilla con muelle

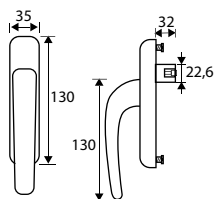

CREMONA SEGURIDAD 6833

	Código	8431488	Medida	Acabado				€uros
	68151	681511	137x32 mm	BL	-	1	5	
	68152	681528	137x32 mm	NE	-	1	5	

Aluminio



2 Patillas

No incluye maneta

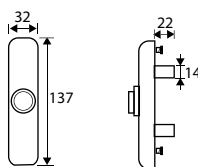

MANETA P/CREMONA 6833

	Código	8431488	Medida	Acabado				€uros
	68153	681535	123x40 mm	BL	-	1	5	
	68154	681542	123x40 mm	NE	-	1	5	

Aluminio



No incluye cremóna

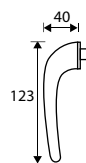

CREMONA + MANETA SEGURIDAD 6833

	Código	8431488	Medida	Acabado				€uros
Blister	91948	919485	137x32 mm	BL	1	-	10	
	91949	919492	137x32 mm	NE	1	-	10	

Aluminio

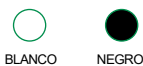

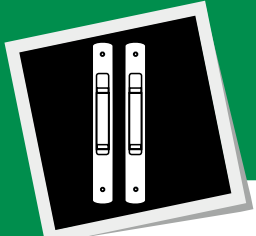

CREMONA SEGURIDAD 6834

Código	8431488	Medida	Acabado				€uros
68155	681559	130x35 mm	BL	-	1	5	
68156	681566	130x35 mm	NE	-	1	5	

2 Patillas
No incluye maneta

Aluminio

BLANCO
 NEGRO

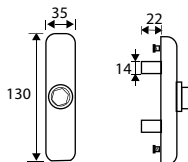

MANETA P/CREMONA 6834

Código	8431488	Medida	Acabado				€uros
68157	681573	130x39 mm	BL	-	1	5	
68158	681580	130x39 mm	NE	-	1	5	

No incluye cremona

Aluminio

BLANCO
 NEGRO

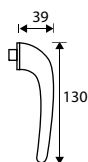

CREMONA + MANETA SEGURIDAD 6834

Código	8431488	Medida	Acabado				€uros
<i>Blister</i> 91950	919508	130x35 mm	BL	1	-	10	
91951	919515	130x35 mm	NE	1	-	10	

Aluminio

BLANCO
 NEGRO



CREMONA 6856

Código	8431488	Medida	Acabado				€uros
68302	683027	120x32 mm	BL	-	1	5	
68303	683034	120x32 mm	NE	-	1	5	

2 patillas

Aluminio

BLANCO
 NEGRO

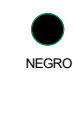
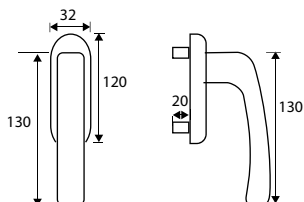

CREMONA AC-20 NEW 6835

	Código	8431488	Medida	Acabado				€uros
	68161	681610	135x30 mm	BL	-	1	5	
	68162	681627	135x30 mm	NE	-	1	5	
Blister	91956	919560	135x30 mm	BL	1	-	10	
	91957	919577	135x30 mm	NE	1	-	10	

Aluminio

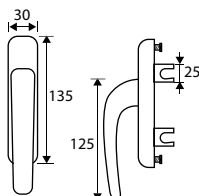

CREMONA AC-20 OLD 6835

	Código	8431488	Medida	Acabado				€uros
	68159	681597	139,5x27 mm	BL	-	1	5	
	68160	681603	139,5x27 mm	NE	-	1	5	
Blister	91954	919546	139,5x27 mm	BL	1	-	10	
	91955	919553	139,5x27 mm	NE	1	-	10	

Aluminio

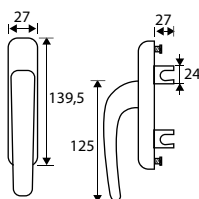

CREMONA FRONTAL 6863

	Código	8431488	Medida	Acabado				€uros
	68327	683270	180x19 mm	BL / NE	-	1	5	
	Blister	92326	923260	180x19 mm	BL / NE	1	-	10

Zamak

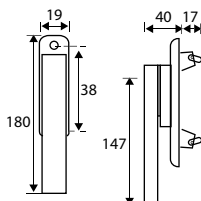

PASADOR SERIE EUROPEA 6837

	Código	8431488	Medida A X B	Acabado				€uros
	68169	681696	142x20 mm	BL	-	1	5	
	68170	681702	142x20 mm	NE	-	1	5	
	68171	681719	217x20 mm	BL	-	1	5	
	68172	681726	217x20 mm	NE	-	1	5	

Aluminio

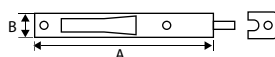

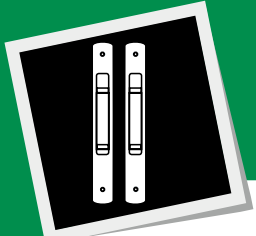

KIT ABATIBLE SERIE 40/20 6852

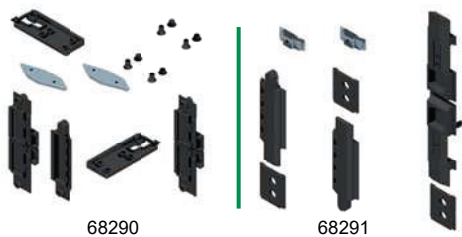

68290

68291

	Código	8431488	Tipo	Acabado				€uros
	68290	682907	1 HOJA	NE	-	1	5	
	68291	682914	2ª HOJA	NE	-	1	5	
<i>Blister</i>	92292	922928	1 HOJA	NE	1	-	10	
	92293	922935	2ª HOJA	NE	1	-	10	

Nylon



NEGRO

KIT ABATIBLE SERIE EUROPEO 6853

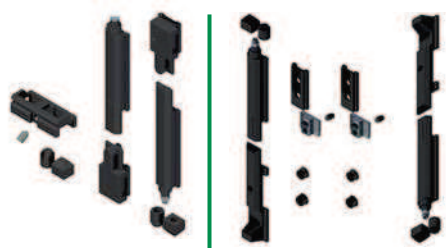

68292

68293

	Código	8431488	Tipo	Acabado				€uros
	68292	682921	1 HOJA	NE	-	1	5	
	68293	682938	2ª HOJA	NE	-	1	5	
<i>Blister</i>	92294	922942	1 HOJA	NE	1	-	10	
	92295	922959	2ª HOJA	NE	1	-	10	

Nylon



NEGRO

CERRADERO SERIE 40/20 6850



	Código	8431488	Medida	Acabado				€uros
	68282	682822	140x31,5 mm	BL	-	1	5	
	68283	682839	140x31,5 mm	NE	-	1	5	
	68284	682846	195x31,5 mm	BL	-	1	5	
	68285	682853	195x31,5 mm	NE	-	1	5	
<i>Blister</i>	92284	922843	140x31,5 mm	BL	1	-	10	
	92285	922850	140x31,5 mm	NE	1	-	10	
	92286	922867	195x31,5 mm	BL	1	-	10	
	92287	922874	195x31,5 mm	NE	1	-	10	

Aluminio



BLANCO

NEGRO

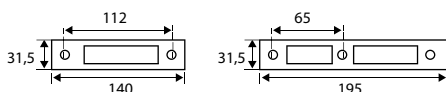

68282-68283

68284-68285

CERRADERO SERIE EUROPEO 6851



	Código	8431488	Medida	Acabado				€uros
	68286	682860	170x22 mm	BL	-	1	5	
	68287	682877	170x22 mm	NE	-	1	5	
	68288	682884	225x22 mm	BL	-	1	5	
	68289	682891	225x22 mm	NE	-	1	5	
<i>Blister</i>	92288	922881	170x22 mm	BL	1	-	10	
	92289	922898	170x22 mm	NE	1	-	10	
	92290	922904	225x22 mm	BL	1	-	10	
	92291	922911	225x22 mm	NE	1	-	10	

Aluminio



BLANCO

NEGRO

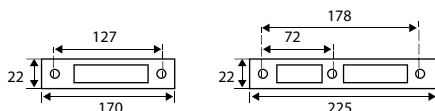

68286-68287

68288-68289

GOLPETE 6810

	Código	8431488	Medida	Acabado				€uros
	68125	681252	47x40 mm	BL	-	1	5	
	68126	681269	47x40 mm	NE	-	1	5	
	68127	681276	47x40 mm	PL	-	1	5	
<i>Blister</i>	91465	914657	47x40 mm	BL	1	-	10	
	91466	914664	47x40 mm	NE	1	-	10	
	91467	914671	47x40 mm	PL	1	-	10	

Aluminio

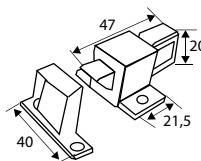

GOLPETE SERIE EUROPEA 6808

	Código	8431488	Medida	Acabado				€uros
	68027	680279	61x25x40 mm	BL	-	1	5	
	68028	680286	61x25x40 mm	NE	-	1	5	
	68029	680293	61x25x40 mm	PL	-	1	5	

Aluminio

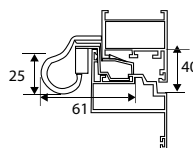

BISAGRA COMPÁS SERIE EUROPEA 6838

	Código	8431488	Medida	Acabado				€uros
	68173	681733	150 mm	BL	-	1	5	
	68174	681740	150 mm	NE	-	1	5	
<i>Blister</i>	91968	919683	150 mm	BL	1	-	10	
	91969	919690	150 mm	NE	1	-	10	

Aluminio

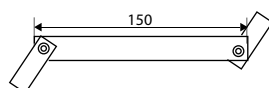

BISAGRA COMPÁS DESMONTABLE 6839

	Código	8431488	Medida	Acabado				€uros
	68175	681757	125 mm	BL	-	1	5	
	68176	681764	125 mm	NE	-	1	5	
<i>Blister</i>	91970	919706	125 mm	BL	1	-	10	
	91971	919713	125 mm	NE	1	-	10	

Aluminio

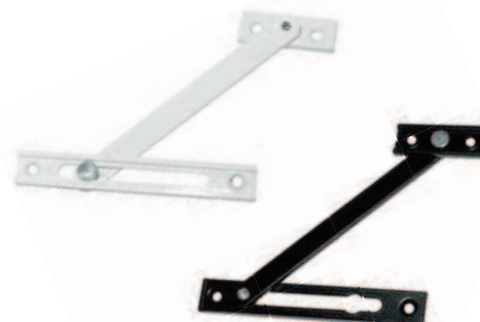
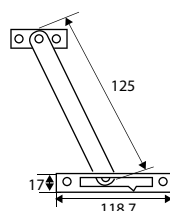
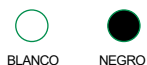

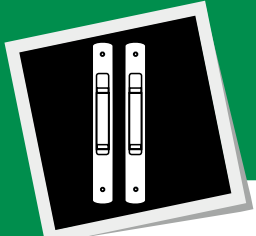

PASADOR PS5 D8

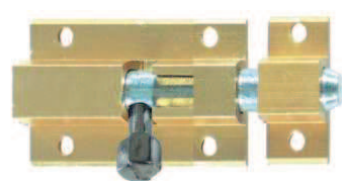
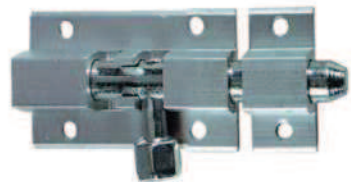
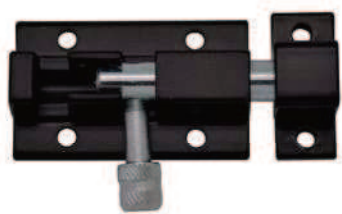

	Código	8431488	Medida A	Acabado				€uros
<i>Caja</i>	63205	632056	50 mm	BL	-	20	-	
	63207	632070	75 mm	BL	-	20	-	
	63210	632100	100 mm	BL	-	20	-	
	63215	632155	150 mm	BL	-	10	-	
	63220	632209	200 mm	BL	-	10	-	
	63225	632254	250 mm	BL	-	10	-	
	63230	632308	300 mm	BL	-	10	-	
	63240	632407	400 mm	BL	-	10	-	
	63247	632476	50 mm	NE	-	20	-	
	63248	632483	75 mm	NE	-	20	-	
	63249	632490	100 mm	NE	-	20	-	
	63250	632506	150 mm	NE	-	10	-	
	63251	632513	200 mm	NE	-	10	-	
	63252	632520	250 mm	NE	-	10	-	
	63253	632537	300 mm	NE	-	10	-	
	63254	632544	400 mm	NE	-	10	-	
	63305	633053	50 mm	PL	-	20	-	
	63307	633077	75 mm	PL	-	20	-	
	63310	633107	100 mm	PL	-	20	-	
	63315	633152	150 mm	PL	-	10	-	
63320	633206	200 mm	PL	-	10	-		
63325	633251	250 mm	PL	-	10	-		
63330	633305	300 mm	PL	-	10	-		
63340	633404	400 mm	PL	-	10	-		
63105	631059	50 mm	OR	-	20	-		
63107	631073	75 mm	OR	-	20	-		
63110	631103	100 mm	OR	-	20	-		
63115	631158	150 mm	OR	-	10	-		
63120	631202	200 mm	OR	-	10	-		
63125	631257	250 mm	OR	-	10	-		
63130	631301	300 mm	OR	-	10	-		
63140	631400	400 mm	OR	-	10	-		
<i>Blister</i>	90163	901633	50 mm	BL	1	-	10	
	91545	915456	75 mm	BL	1	-	10	
	90164	901640	100 mm	BL	1	-	10	
	91546	915463	50 mm	NE	1	-	10	
	91547	915470	75 mm	NE	1	-	10	
	91697	916972	100 mm	NE	1	-	10	
	90165	901657	50 mm	PL	1	-	10	
	91548	915487	75 mm	PL	1	-	10	
	90166	901664	100 mm	PL	1	-	10	
	90161	901619	50 mm	OR	1	-	10	
	91549	915494	75 mm	OR	1	-	10	
	90162	901626	100 mm	OR	1	-	10	

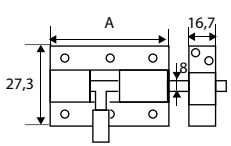

Aluminio

BLANCO
 NEGRO
 PLATA
 ORO

PASADOR PS5 D12

Código	8431488	Medida A	Acabado				€uros
63241	632414	100 mm	BL	-	1	10	
63242	632421	150 mm	BL	-	1	10	
63243	632438	200 mm	BL	-	1	5	
63244	632445	250 mm	BL	-	1	5	
63245	632452	300 mm	BL	-	1	5	
63246	632469	400 mm	BL	-	1	5	
63255	632551	100 mm	NE	-	1	10	
63256	632568	150 mm	NE	-	1	10	
63257	632575	200 mm	NE	-	1	5	
63258	632582	250 mm	NE	-	1	5	
63259	632599	300 mm	NE	-	1	5	
63260	632605	400 mm	NE	-	1	5	
63341	633411	100 mm	PL	-	1	10	
63342	633428	150 mm	PL	-	1	10	
63343	633435	200 mm	PL	-	1	5	
63344	633442	250 mm	PL	-	1	5	
63345	633459	300 mm	PL	-	1	5	
63346	633466	400 mm	PL	-	1	5	
63141	631417	100 mm	OR	-	1	10	
63142	631424	150 mm	OR	-	1	10	
63143	631431	200 mm	OR	-	1	5	
63144	631448	250 mm	OR	-	1	5	
63145	631455	300 mm	OR	-	1	5	
63146	631462	400 mm	OR	-	1	5	



Aluminio

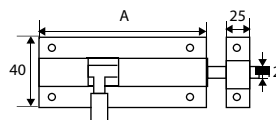

PASADOR RULETA 6825

Código	8431488	Medida	Acabado				€uros
68132	681320	48,5x32 mm	BL	-	1	10	
68133	681337	48,5x32 mm	NE	-	1	10	
68134	681344	48,5x32 mm	PL	-	1	10	
91462	914626	48,5x32 mm	BL	1	-	10	
91463	914633	48,5x32 mm	NE	1	-	10	
91464	914640	48,5x32 mm	PL	1	-	10	

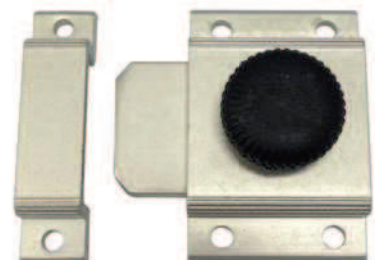

Aluminio

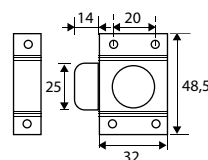

ESCUDO BOCALLAVE 6811

Código	8431488	Medida	Acabado				€uros
68021	680217	70x30 mm	BL	-	10	100	
68022	680224	70x30 mm	NE	-	10	100	
91460	914602	70x30 mm	BL	2	-	10	
91461	914619	70x30 mm	NE	2	-	10	



Nylon

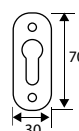

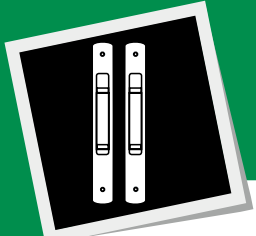

ALUMINIO

MANILLÓN 6860



	Código	8431488	Medida	Acabado				€uros
	68318	683188	350 mm	BL/NE	-	1	-	
	68319	683195	350 mm	NE	-	1	-	
	68320	683201	350 mm	PL/NE	-	1	-	

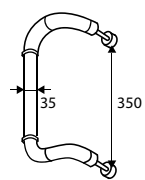

Nylon

JGO MANILLÓN 6860



	Código	8431488	Medida	Acabado				€uros
	68321	683218	350 mm	BL/NE	-	1	-	
	68322	683225	350 mm	NE	-	1	-	
	68323	683232	350 mm	PL/NE	-	1	-	

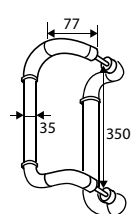

Nylon

MANILLÓN DESPLAZADO 6866



	Código	8431488	Medida	Acabado				€uros
	68333	683331	300 mm	PL	-	1	-	

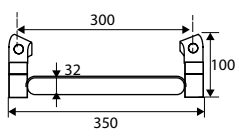

Aluminio

JGO MANILLÓN 6854

	Código	8431488	Medida /Mano	Acabado				€uros
	68294	682945	350 mm	BL	-	1	-	
	68295	682952	350 mm	NE	-	1	-	
	68296	682969	350 mm	EI	-	1	-	

Zamak



Incluye mecanismo individual

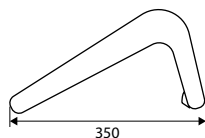

JGO MANILLÓN 6861

	Código	8431488	Medida	Acabado				€uros
	68324	683249	350 mm	BL	-	1	-	
	68325	683256	350 mm	NE	-	1	-	

Aluminio

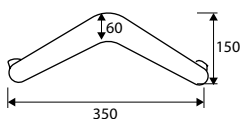

MECANISMO INDIVIDUAL MANILLÓN 6861

	Código	8431488	Medida	Acabado				€uros
	68326	683263	100x30x30 mm	ZN	-	1	6	

Acero



ESTUCHE RODAMIENTOS SURTIDOS RD41

	Código	8431488	Medida A - B	Acabado				€uros
Caja	68244	682440	310x240x50 mm	NE	-	1	-	

Contiene 24 referencias - 170 unidades

Ref.	Descripción	Uds.	Ref.	Descripción	Uds.
68227	RODAMIENTO MOSQUITERA GRANDE	12	68204	RODAMIENTO METALICO INASA 162	4
68226	RODAMIENTO MOSQUITERA PEQUEÑO	12	68202	RODAMIENTO METALICO 158	4
68211	RODAMIENTO MAMPARA 26mm	15	68201	RODAMIENTO METALICO 157	4
68210	RODAMIENTO MAMPARA 20mm	25	68200	RODAMIENTO METALICO INASA 151	6
68221	RODAMIENTO MAMPARA 16mm	25	68207	RODAMIENTO NYLON 172	4
68224	RODAMIENTO MAMPARA ART 26mm	4	68212	RODAMIENTO NYLON CO22	3
68223	RODAMIENTO MAMPARA TUBO 24mm	6	68208	RODAMIENTO NYLON ENDASA CLL	5
68222	RODAMIENTO MAMPARA TUBO 22mm	6	68233	RODAMIENTO NYLON 300 ALTA	3
68206	RODAMIENTO NYLON INASA 163	3	68234	RODAMIENTO NYLON ELITE VENTANA	4
68232	RODAMIENTO ALUMINIO CO-1B	5	68235	RODAMIENTO NYLON TRIANA	4
68209	RODAMIENTO METALICO CLL/104	5	68236	RODAMIENTO NYLON ALUPRON 21	4
68205	RODAMIENTO METALICO CLIMALIT 177	3	68225	RODAMIENTO NYLON ALUGOM 400	4



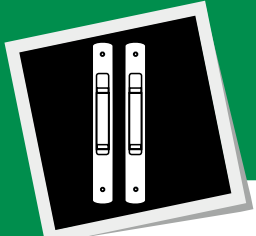

RODAMIENTO 172 RD7

	Código	8431488	Medida	Acabado				€uros
Caja	68207	682075	40x30 mm	BL	-	12	300	
Blister	91334	913346	40x30 mm	BL	2	-	10	

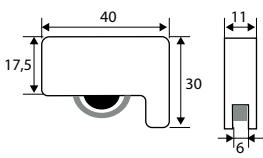

Nylon



RODAMIENTO CO-22 RD8

	Código	8431488	Medida	Acabado				€uros
Caja	68212	682129	37x39,5 mm	BL	-	12	300	
Blister	91339	913391	37x39,5 mm	BL	2	-	10	

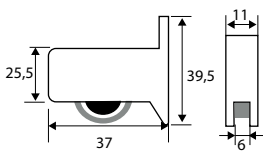

Nylon



RODAMIENTO INASA 163 RD9

	Código	8431488	Medida	Acabado				€uros
Caja	68206	682068	40x33,5 mm	BL	-	12	300	
Blister	91333	913339	40x33,5 mm	BL	2	-	10	

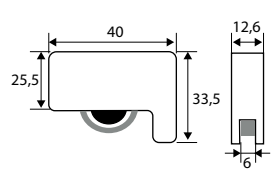

Nylon



RODAMIENTO ENDASA CLL RD10

	Código	8431488	Medida	Acabado				€uros
Caja	68208	682082	33,5x15,5 mm	BL	-	12	300	
Blister	91335	913353	33,5x15,5 mm	BL	2	-	10	

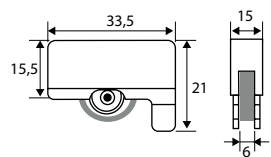

Nylon



RODAMIENTO 300 ALTA RD11

	Código	8431488	Medida	Acabado				€uros
Caja	68233	682334	40x30 mm	BL	-	10	120	
Blister	91898	918983	40x30 mm	BL	2	-	10	

Nylon



BLANCO

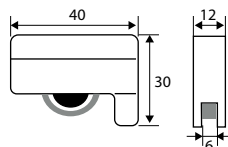

RODAMIENTO ALUGOM 400 RD20

	Código	8431488	Medida	Acabado				€uros
Caja	68225	682259	64x25 mm	NE	-	12	240	
Blister	91800	918006	64x25 mm	NE	2	-	10	

Nylon



NEGRO



Triple regulación de altura

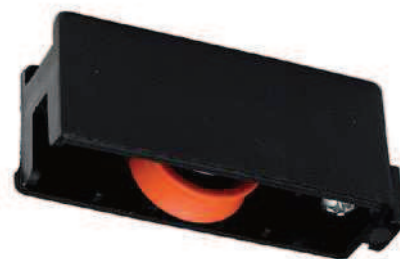
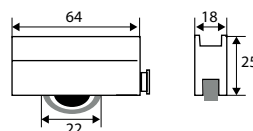

RODAMIENTO ALUPRON 21 RD21

	Código	8431488	Medida	Acabado				€uros
Caja	68236	682365	56x26 mm	NE	-	12	120	
Blister	91901	919010	56x26 mm	NE	2	-	10	

Nylon



NEGRO



Triple regulación de altura

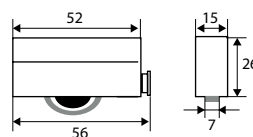

RODAMIENTO P-60 RD22

	Código	8431488	Medida	Acabado				€uros
Caja	68237	682372	57x21 mm	NE	-	12	120	
Blister	91902	919027	57x21 mm	NE	2	-	10	

Nylon



NEGRO



Triple regulación de altura

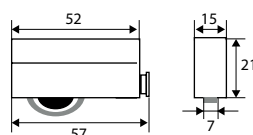

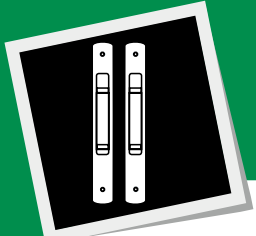

RODAMIENTO ÉLITE VENTANA RD23



	Código	843 1488	Medida	Acabado				€uros
Caja	68234	682341	52,5x24 mm	NE	-	12	120	
Blistar	91899	918990	52,5x24 mm	NE	2	-	10	

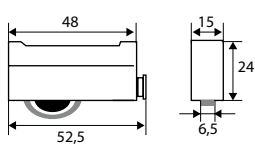

Nylon



Doble regulación de altura

RODAMIENTO TRIANA RD24



	Código	843 1488	Medida	Acabado				€uros
Caja	68235	682358	54,5x23 mm	NE	-	12	120	
Blistar	91900	919003	54,5x23 mm	NE	2	-	10	

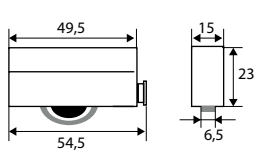

Nylon



Triple regulación de altura

RODAMIENTO INASA 151 RD12



	Código	843 1488	Medida	Acabado				€uros
Caja	68200	682006	36x12,2 mm	ZN	-	12	300	
Blistar	91327	913278	36x12,2 mm	ZN	2	-	10	

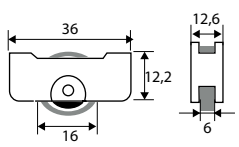

Acero



RODAMIENTO 157 RD13



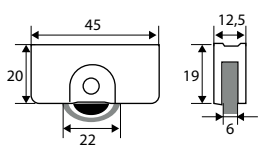

	Código	843 1488	Medida	Acabado				€uros
Caja	68201	682013	45x20 mm	BC	-	12	300	
Blistar	91328	913285	45x20 mm	BC	2	-	10	



Acero



RODAMIENTO 158 RD14

	Código	8431488	Medida	Acabado				€uros
Caja	68202	682020	45x20 mm	BC	-	12	300	
Blister	91329	913292	45x20 mm	BC	2	-	10	



Acero

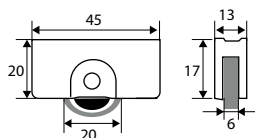

BICROMATADO



RODAMIENTO 158/S RD15

	Código	8431488	Medida	Acabado				€uros
Caja	68203	682037	45x20 mm	BC	-	12	300	
Blister	91330	913308	45x20 mm	BC	2	-	10	



Acero

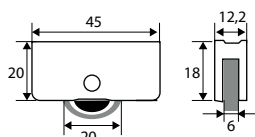

BICROMATADO



RODAMIENTO INASA 162 RD16

	Código	8431488	Medida	Acabado				€uros
Caja	68204	682044	45x25,5 mm	ZN	-	12	300	
Blister	91331	913315	45x25,5 mm	ZN	2	-	10	



Acero

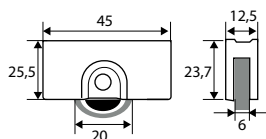

ZINCADO



RODAMIENTO CLIMALIT 177 RD17

	Código	8431488	Medida	Acabado				€uros
Caja	68205	682051	40x21 mm	ZN	-	12	300	
Blister	91332	913322	40x21 mm	ZN	2	-	10	

Acero



ZINCADO

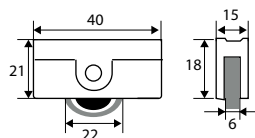

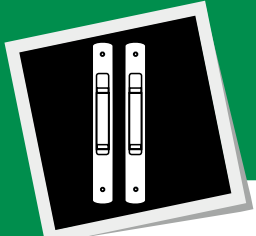

RODAMIENTO CLL/ 104 RD18



	Código	8431488	Medida	Acabado				€uros
Caja	68209	682099	45,2x15 mm	BC	-	12	300	
Blister	91336	913360	45,2x15 mm	BC	2	-	10	

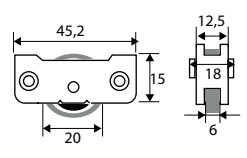

Acero

 BICROMATADO

RODAMIENTO CO-22 RD19

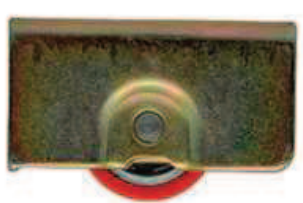

	Código	8431488	Medida	Acabado				€uros
Caja	68267	682679	40x16 mm	BC	-	12	300	
Blister	92230	922300	40x16 mm	BC	2	-	10	

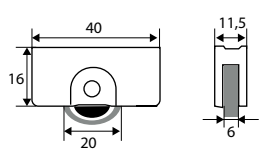

Acero

 BICROMATADO

RODAMIENTO REGULABLE INASA 2000 RD34



	Código	8431488	Medida	Acabado				€uros
Caja	68230	682303	55x20 mm	ZN	-	12	300	
Blister	91895	918952	55x20 mm	ZN	2	-	10	

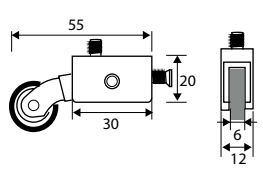

Acero

 ZINCADO

RODAMIENTO REGULABLE INASA 300 RD35



	Código	8431488	Medida	Acabado				€uros
Caja	68231	682310	57x25 mm	ZN	-	12	120	
Blister	91896	918969	57x25 mm	ZN	2	-	10	

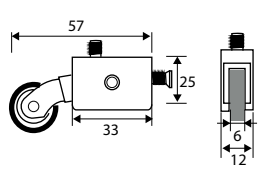

Acero

 ZINCADO

RODAMIENTO CO-1B RD31

	Código	8431488	Medida	Acabado			€uros
Caja	68232	682327	40x12 mm	AL	-	12 300	
Blister	91897	918976	40x12 mm	AL	2	- 10	

Aluminio

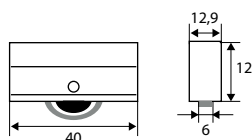

RODAMIENTO CO-36 RD32

	Código	8431488	Medida	Acabado			€uros
Caja	68265	682655	39x16 mm	ZN	-	12 300	
Blister	92228	922287	39x16 mm	ZN	2	- 10	

Zamak

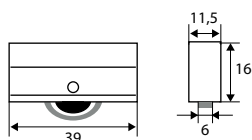

RODAMIENTO CO-22 RD33

	Código	8431488	Medida	Acabado			€uros
Caja	68266	682662	39x14 mm	AL	-	12 300	
Blister	92229	922294	39x14 mm	AL	2	- 10	

Aluminio

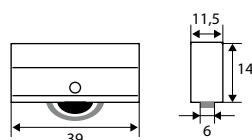

RODAMIENTO VITRINA RD29

	Código	8431488	Medida	Acabado			€uros
Caja	68228	682280	40x11 mm	ZN	-	12 300	
Blister	91893	918938	40x11 mm	ZN	2	- 10	

Acero

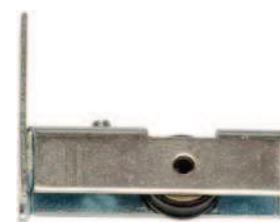
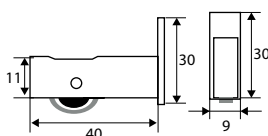

RODAMIENTO VITRINA RD30

	Código	8431488	Medida	Acabado			€uros
Caja	68229	682297	56,5x14 mm	NE	-	12 300	
Blister	91894	918945	56,5x14 mm	NE	2	- 10	

Nylon

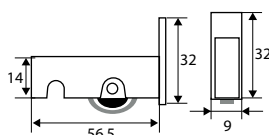

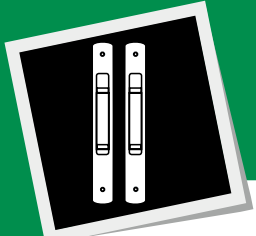

RODAMIENTO REGULABLE ALUGOM 400 RD36

	Código	8431488	Medidas	Acabado				€uros
Caja	68260	682600	75x18 mm	ZN	-	12	120	
Blister	92222	922225	75x18 mm	ZN	2	-	10	

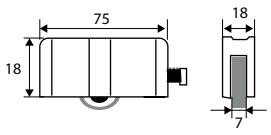

Acero

ZINCADO

RODAMIENTO REGULABLE ALUPRON 21 RD37

	Código	8431488	Medida	Acabado				€uros
Caja	68261	682617	70x16 mm	ZN	-	12	120	
Blister	92223	922232	70x16 mm	ZN	2	-	10	

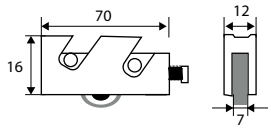

Acero

ZINCADO

RODAMIENTO REGULABLE SILVER 60 RD38

	Código	8431488	Medida	Acabado				€uros
Caja	68262	682624	79x21 mm	ZN	-	12	120	
Blister	92224	922249	79x21 mm	ZN	2	-	10	

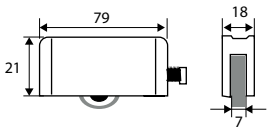

Acero

ZINCADO

RODAMIENTO REGULABLE P60/P65 RD39

	Código	8431488	Medida	Acabado				€uros
Caja	68263	682631	75x15 mm	ZN	-	12	120	
Blister	92225	922256	75x15 mm	ZN	2	-	10	

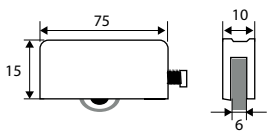

Acero

ZINCADO

RODAMIENTO REGULABLE CORTIZO 5200 RD40

	Código	8431488	Medida	Acabado				€uros
Caja	68264	682648	72x28 mm	ZN	-	12	120	
Blister	92226	922263	72x28 mm	ZN	2	-	10	

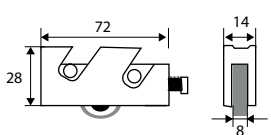

Acero

ZINCADO

RODAMIENTO MAMPARA RD1

	Código	8431488	Medida A	Acabado				€uros
Caja	68221	682211	16 mm	NE	-	25	625	
	68210	682105	20 mm	NE	-	25	625	
	68211	682112	26 mm	NE	-	25	625	
Blister	91796	917962	16 mm	NE	2	-	10	
	91337	913377	20 mm	NE	2	-	10	
	91338	913384	26 mm	NE	2	-	10	

Nylon



Incluye tornillo

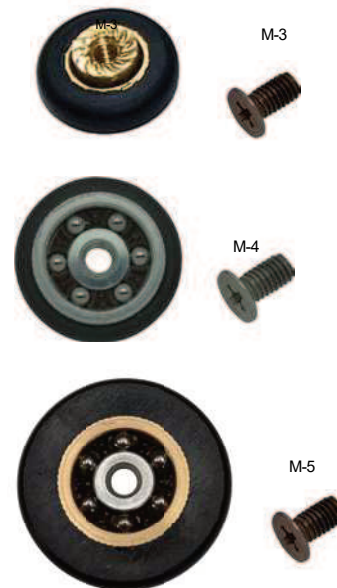
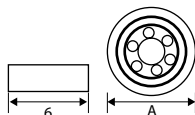

RODAMIENTO MAMPARA C/SEPARADOR RD1

	Código	8431488	Medida A - Separador B	Acabado				€uros
Caja	68251	682518	20 mm - 6 mm	NE	-	12	300	
	68252	682525	20 mm - 12 mm	NE	-	12	300	
	68253	682532	20 mm - 17 mm	NE	-	12	300	
	68254	682549	26 mm - 6 mm	NE	-	12	300	
	68255	682556	26 mm - 12 mm	NE	-	12	300	
	68256	682563	26 mm - 17 mm	NE	-	12	300	
Blister	92213	922133	20 mm - 6 mm	NE	2	-	10	
	92214	922140	20 mm - 12 mm	NE	2	-	10	
	92215	922157	20 mm - 17 mm	NE	2	-	10	
	92216	922164	26 mm - 6 mm	NE	2	-	10	
	92217	922171	26 mm - 12 mm	NE	2	-	10	
	92218	922188	26 mm - 17 mm	NE	2	-	10	

Nylon

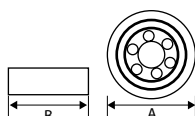

SEPARADOR P/RODAMIENTO MAMPARA RD1

	Código	8431488	Medida A	Acabado				€uros
Caja	68257	682570	6 mm	LT	-	25	625	
	68258	682587	12 mm	LT	-	25	625	
	68259	682594	17 mm	LT	-	25	625	
Blister	92219	922195	6 mm	LT	2	-	10	
	92220	922201	12 mm	LT	2	-	10	
	92221	922218	17 mm	LT	2	-	10	

Latón



TORNILLO RODAMIENTO MAMPARA RD1

	Código	8431488	Medida AxB	Acabado				€uros
Caja	68249	682495	M3x6 mm	INOX	-	25	2500	
	68213	682136	M4x8 mm	INOX	-	25	2500	
	68250	682501	M5x8 mm	INOX	-	12	2400	

Acero Inoxidable

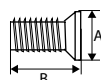

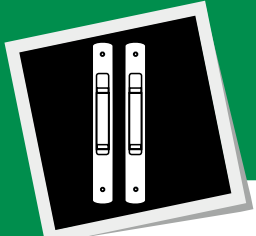

RODAMIENTO MAMPARA RD25

	Código	843 1488	Medida	Acabado				€uros
Caja	68238	682389	22x19 mm	BL	-	12	300	
Blíster	91903	919034	22x19 mm	BL	2	-	10	

Incluye tornillo M5

Nylon

BLANCO

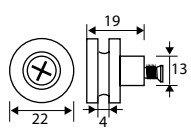

RODAMIENTO MAMPARA RD26

	Código	843 1488	Medida	Acabado				€uros
Caja	68239	682396	25x19 mm	BL	-	12	300	
Blíster	91904	919041	25x19 mm	BL	2	-	10	

Incluye tornillo M5

Nylon

BLANCO

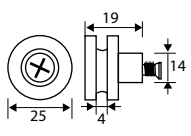

RODAMIENTO MAMPARA RD27

	Código	843 1488	Medida	Acabado				€uros
Caja	68240	682402	25x16 mm	BL	-	12	300	
Blíster	91905	919058	25x16 mm	BL	2	-	10	

Incluye tornillo M5

Nylon

BLANCO

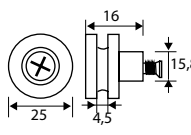

RODAMIENTO MAMPARA RD28

	Código	843 1488	Medida	Acabado				€uros
Caja	68241	682419	24x16 mm	BL	-	12	300	
Blíster	91906	919065	24x16 mm	BL	2	-	10	

Incluye tornillo M5

Nylon

BLANCO

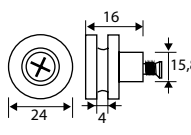

RODAMIENTO MAMPARA RD2

	Código	8431488	Medida	Acabado				€uros
Caja	68222	682228	22 mm	BL	-	12	300	
	68223	682235	24 mm	BL	-	12	300	
Blister	91797	917979	22 mm	BL	2	-	10	
	91798	917986	24 mm	BL	2	-	10	

Nylon
 BLANCO

Incluye tornillo

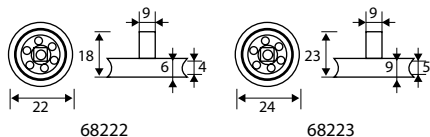

RODAMIENTO MAMPARA ARTICULADO RD3

	Código	8431488	Medida	Acabado				€uros
Caja	68224	682242	26 mm	BL	-	12	300	
Blister	91799	917993	26 mm	BL	2	-	10	

Nylon
 BLANCO

Incluye tornillo

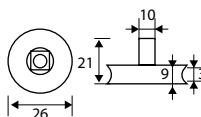

RODAMIENTO MAMPARA ARTICULADO RD6

	Código	8431488	Medida	Acabado				€uros
Caja	68269	682693	21 mm	BL	-	12	120	
Blister	92235	922355	21 mm	BL	2	-	10	

Nylon
 BLANCO

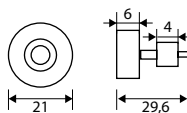

JGO RODAMIENTO MAMPARA RD4

	Código	8431488	Medidas	Acabado				€uros
Caja	68268	682686	23 mm	GR/BL	-	2	50	
Blister	92231	922317	23 mm	GR/BL	1	-	10	

Nylon
 GRIS/
BLANCO

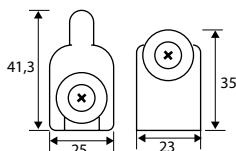

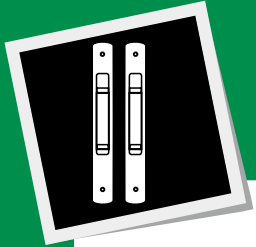

ALUMINIO

RODAMIENTO MOSQUITERA RD5



	Código	8431488	Medida A	Acabado				€uros
Caja	68226	682266	21 mm	NE	-	12	300	
	68227	682273	23 mm	NE	-	12	300	
Blister	91891	918914	21 mm	NE	2	-	10	
	91892	918921	23 mm	NE	2	-	10	

Poliamida

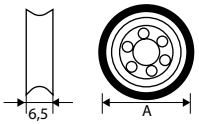

KIT MOSQUITERA CORREDERA MQ2



	Código	8431488	Medida	Acabado				€uros
	68247	682471	pequeño	BL	-	5	50	
	68248	682488	pequeño	NE	-	5	50	
	68245	682457	grande	BL	-	5	50	
	68246	682464	grande	NE	-	5	50	
Blister	92186	921860	pequeño	BL	1	-	10	
	92187	921877	pequeño	NE	1	-	10	
	92184	921846	grande	BL	1	-	10	
	92185	921853	grande	NE	1	-	10	

Poliamida

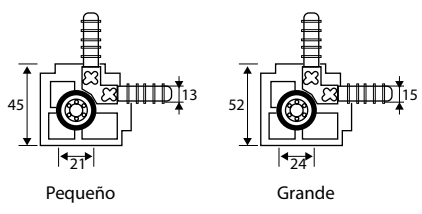

JGO ENGANCHE MOSQUITERA MQ1



	Código	8431488	Medida	Acabado				€uros
	68242	682426	52,5x30 mm	BL	-	10	100	
	68243	682433	52,5x30 mm	NE	-	10	100	
Blister	92137	921372	52,5x30 mm	BL	1	-	10	
	92138	921389	52,5x30 mm	NE	1	-	10	

Nylon

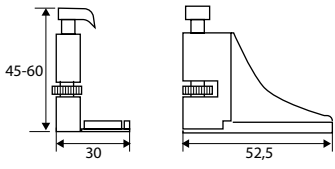





LLAMADOR INGLÉS LLM1



	Código	8431488	Medida AxB	Acabado				€uros
Caja	10018	100180	200X90 mm	LP	-	1	20	
	10182	101828	200X90 mm	NS	-	1	20	
	11181	111810	200X90 mm	NE	-	1	20	
Blister	90650	906508	200x90 mm	LP	1	-	10	
	90652	906522	200x90 mm	NS	1	-	10	
	90654	906546	200x90 mm	NE	1	-	10	

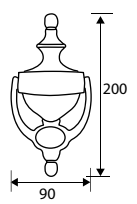

Latón

LATÓN PULIDO
 NÍQUEL SATINADO
 NEGRO

POMO PUERTA OCTOGONAL PP3



	Código	8431488	Medida	Acabado				€uros
Caja	10011	100111	65 mm	LP	-	1	48	

Separado placa y pomo

Latón - M8

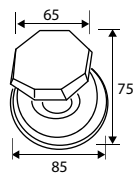

LATÓN PULIDO

POMO PUERTA AROS PP1



	Código	8431488	Medida	Acabado				€uros
Caja	10008	100081	70 mm	LP	-	1	48	
	10002	100029	70 mm	NS	-	1	48	

Placa y pomo unidos

Latón - M8

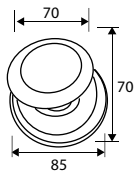

LATÓN PULIDO
 NÍQUEL SATINADO

POMO PUERTA LISO PP2

	Código	8431488	Medida	Acabado				€uros
Caja	10009	100098	70 mm	LP	-	1	48	
	10239	100920	70 mm	NS	-	1	48	
	10240	100937	70 mm	CU	-	1	48	
	11092	110929	70 mm	NE	-	1	48	
	11904	119045	70 mm	INOX	-	1	24	

10009-10239-10240-11092: Latón - M8
11904: Acero Inoxidable - M8

Placa y pomo unidos

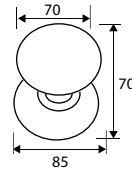

POMO PUERTA BOLA PP5

	Código	8431488	Medida	Acabado				€uros
Caja	10003	100036	60 mm	INOX	-	1	24	
	10001	100012	70 mm	INOX	-	1	24	

Acero Inoxidable - M8

Placa y pomo unidos

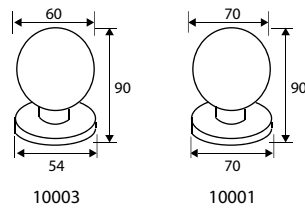

POMO PUERTA BOLA PP4



	Código	8431488	Medida	Acabado				€uros
Caja	10010	100104	75 mm	LP	-	1	24	
	10249	101057	75 mm	NS	-	1	24	

Latón - M8

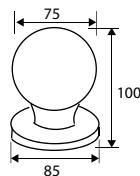
Placa y pomo unidos



POMO PUERTA MARGARITA PP6

	Código	8431488	Medida	Acabado				€uros
Caja	10200	102009	75 mm	LP	-	1	24	
	10110	101101	75 mm	CU	-	1	24	

Latón - M8

Placa y pomo unidos

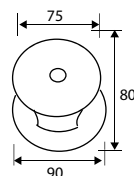



MANILLÓN TORNEADO MN4

Código	8431488	Tipo	Acabado				€uros
10006	100067	300 mm	LP	-	1	-	
10620	106205	300 mm	NS	-	1	-	
10630	106304	300 mm	NE	-	1	-	
10007	100074	400 mm	LP	-	1	-	

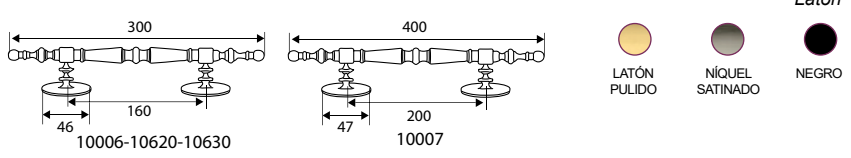

MANILLÓN TORNEADO MN7

Código	8431488	Tipo	Acabado				€uros
10169	101699	300 mm	LP	-	1	-	



MANILLÓN DESPLAZADO MN8

Código	8431488	Tipo	Acabado				€uros
10178	101781	300 mm	LP	-	1	-	



MANILLÓN TORNEADO EXTENSIBLE MN5

Código	8431488	Tipo A	Acabado				€uros
10162	101620	140 - 230 mm	LP	-	1	-	
10179	101798	230 - 300 mm	LP	-	1	-	



MANILLÓN DESPLAZADO EXTENSIBLE MN6

Código	8431488	Tipo - A	Acabado				€uros
10163	101637	140 - 230 mm	LP	-	1	-	
10180	101804	230 - 300 mm	LP	-	1	-	



JGO MANILLÓN RECTO MN3

	Código	8431488	Medida AxBxC	Acabado			€uros
Caja	42300	423005	300x450x30 mm	INOX	-	1 10	
	42350	423500	350x500x30 mm	INOX	-	1 10	
	42450	424507	450x600x30 mm	INOX	-	1 10	
	42600	426006	600x750x30 mm	INOX	-	1 10	
	42900	429007	900x1050x30 mm	INOX	-	1 10	

Acero Inoxidable

Se unen con espárrago roscado al manillón sujeto mediante un prisionero



INOX

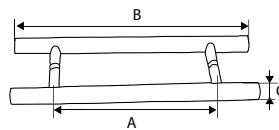

JGO MANILLÓN RECTO MN2

	Código	8431488	Medida AxBxC	Acabado			€uros
Caja	41250	412504	250x275x25 mm	INOX	-	1 -	
	41300	413006	300x325x25 mm	INOX	-	1 -	
	41425	414256	425x450x25 mm	INOX	-	1 -	

Acero Inoxidable

Se unen con espárrago roscado al manillón sujeto mediante un prisionero



INOX

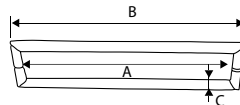

JGO MANILLÓN CURVA MN1

	Código	8431488	Medida AxBxC	Acabado			€uros
Caja	40250	402505	250x270x25 mm	INOX	-	1 10	
	40300	403007	300x325x25 mm	INOX	-	1 10	

Acero Inoxidable

Se unen con espárrago roscado al manillón sujeto mediante un prisionero



INOX

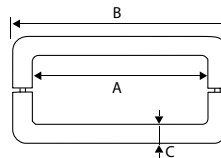

JGO MANILLÓN HUESO MN9

	Código	8431488	Medida	Acabado			€uros
Caja	02131	021317	200 mm	LTD	-	1 20	
	02132	021324	200 mm	LS	-	1 20	
	02133	021331	200 mm	NS	-	1 20	
	02134	021348	200 mm	CU	-	1 20	
	02135	021355	200 mm	CB	-	1 20	
	02136	021362	200 mm	NE	-	1 20	

Zamak

Se puede usar como juego o individual

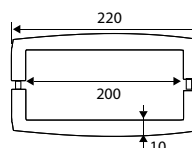



JGO OJO DE BUEY OB1

	Código	8431488	Medida	Acabado				€uros
Caja	54535	545356	380 mm	INOX	-	1	5	

Acero Inoxidable



INOX



No incluye cristal

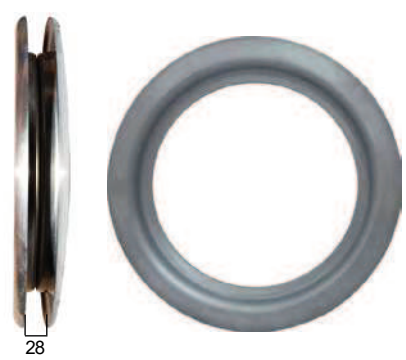

28

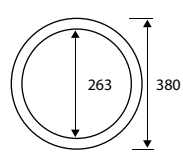

MIRILLA 180° - ø 14 MM MR1

	Código	8431488	Medida A	Acabado				€uros
	10131	101316	15/25 mm	LTD	-	12	300	
	10132	101323	25/42 mm	LTD	-	12	300	
	10013	100135	35/60 mm	LTD	-	12	300	
	10138	101385	60/100 mm	LTD	-	12	300	
	10139	101392	15/25 mm	NS	-	12	300	
	10136	101361	25/42 mm	NS	-	12	300	
	10134	101347	35/60 mm	NS	-	12	300	
	10130	101309	60/100 mm	NS	-	12	300	
	10137	101378	35/60 mm	CU	-	12	300	
<i>Blister</i>	90101	901015	25/42 mm	LTD	1	-	10	
	90103	901039	35/60 mm	LTD	1	-	10	
	90108	901084	25/42 mm	NS	1	-	10	
	90110	901107	35/60 mm	NS	1	-	10	
	90106	901060	35/60 mm	CU	1	-	10	

Presentación en caja individual

Zamak

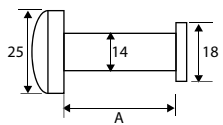

MIRILLA 180° - ø 16 MM MR2

	Código	8431488	Medida	Acabado				€uros
	10165	101651	35/60 mm	LTD	-	12	300	
	10166	101668	35/60 mm	NS	-	12	300	
<i>Blister</i>	91880	918808	35/60 mm	LTD	1	-	10	
	91881	918815	35/60 mm	NS	1	-	10	

Presentación en caja individual

Zamak

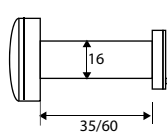

EMBELLECEDOR MIRILLA MR3

	Código	8431488	Medida	Acabado				€uros
Caja	10012	100128	45 mm	LP	-	10	250	
	10242	101224	45 mm	NS	-	10	250	
	10123	101231	45 mm	CU	-	1	10	
	10124	101248	45 mm	NE	-	1	10	

Latón

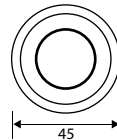

MIRILLA 180° MR1- ø 14 MM + EMBELLECEDOR MR3

	Código	8431488	Medida	Acabado				€uros
Blister	90102	901022	35/60 mm	LTD	1	-	10	
	90109	901091	35/60 mm	NS	1	-	10	

Mirilla: Zamak
Embellecedor: Latón



MIRILLA DIGITAL MD1

	Código	8431488	Medida	Acabado				€uros
Blister	10167	101675	115x62 mm	OR	1	-	32	
	10168	101682	115x62 mm	PL	1	-	32	

Acero / ABS

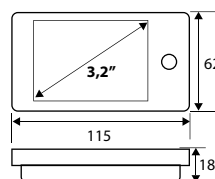

Presentación en caja con colgador

Pantalla de 3,2 pulgadas
Ángulo de visión 160°
Sensor de 1,3 Mega Píxeles
Espesor puerta 42 a 72 mm
Alimentación 3 pilas AAA (no incluidas)





CLAVO REDONDO CL1

	Código	8431488	Medida AxB	Acabado				€uros
Caja	11725	117256	25x30 mm	NE	-	25	250	
	11701	117010	30x30 mm	NE	-	25	250	
	11726	117263	35x30 mm	NE	-	25	250	
	11702	117027	40x30 mm	NE	-	25	250	

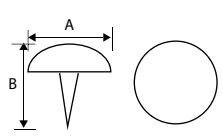

Acero
●
NEGRO



CLAVO GOLF CL2

	Código	8431488	Medida AxB	Acabado				€uros
Caja	11727	117270	25x30 mm	NE	-	25	250	
	11728	117287	30x30 mm	NE	-	25	250	
	11735	117355	35x30 mm	NE	-	25	250	
	11736	117362	40x30 mm	NE	-	25	250	

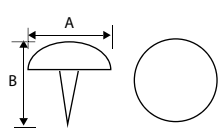

Acero
●
NEGRO



CLAVO PIRÁMIDE CL3

	Código	8431488	Medida AxB	Acabado				€uros
Caja	11729	117294	25x30 mm	NE	-	25	250	
	11703	117034	30x30 mm	NE	-	25	250	
	11730	117300	35x30 mm	NE	-	25	250	

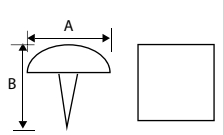

Acero
●
NEGRO



CLAVO 8 PICOS CL4

	Código	8431488	Medida AxB	Acabado				€uros
Caja	11731	117317	30x30 mm	NE	-	25	250	
	11732	117324	40x30 mm	NE	-	25	250	

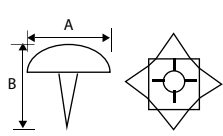

Acero
●
NEGRO



CLAVO 4 PICOS CL5

	Código	8431488	Medida AxB	Acabado				€uros
Caja	11733	117331	20x20 mm	NE	-	25	250	
	11734	117348	40x30 mm	NE	-	25	250	

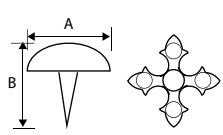

Acero
●
NEGRO

PLACA CIEGA PLP1

Código	8431488	Medida AxB	Acabado				€uros
97816	978161	60x35 mm	LP	-	2	-	
97817	978178	60x35 mm	LS	-	2	-	
97818	978185	60x35 mm	NS	-	2	-	
97819	978192	60x60 mm	LP	-	2	-	
97820	978208	60x60 mm	LS	-	2	-	
97821	978215	60x60 mm	NS	-	2	-	
97822	978222	80x60 mm	LP	-	2	-	
97823	978239	80x60 mm	LS	-	2	-	
97824	978246	80x60 mm	NS	-	2	-	
97801	978017	80x80 mm	LP	-	2	-	
97802	978024	80x80 mm	LS	-	2	-	
97803	978031	80x80 mm	NS	-	2	-	
97804	978048	100x70 mm	LP	-	2	-	
97805	978055	100x70 mm	LS	-	2	-	
97806	978062	100x70 mm	NS	-	2	-	
97807	978079	250x90 mm	LP	-	2	-	
97808	978086	250x90 mm	LS	-	2	-	
97809	978093	250x90 mm	NS	-	2	-	
91522	915227	60x35 mm	LP	1	-	10	
91523	915234	60x35 mm	LS	1	-	10	
91524	915241	60x35 mm	NS	1	-	10	
91525	915258	60x60 mm	LP	1	-	10	
91526	915265	60x60 mm	LS	1	-	10	
91527	915272	60x60 mm	NS	1	-	10	
91528	915289	80x60 mm	LP	1	-	10	
91529	915296	80x60 mm	LS	1	-	10	
91530	915302	80x60 mm	NS	1	-	10	
90479	904795	80x80 mm	LP	1	-	10	
90480	904801	80x80 mm	LS	1	-	10	
90481	904818	80x80 mm	NS	1	-	10	
90482	904825	100x70 mm	LP	1	-	10	
90483	904832	100x70 mm	LS	1	-	10	
90484	904849	100x70 mm	NS	1	-	10	



Latón



Espesor 1 mm

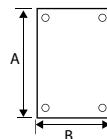

PLACA CIEGA PLP3

Código	8431488	Medida AxB	Acabado				€uros
97834	978345	600x250 mm	INOX	-	1	-	
97835	978352	700x250 mm	INOX	-	1	-	
97836	978369	800x250 mm	INOX	-	1	-	
97837	978376	900x250 mm	INOX	-	1	-	
97838	978383	1000x250 mm	INOX	-	1	-	
97839	978390	1200x250 mm	INOX	-	1	-	

Acero Inoxidable



Espesor 1 mm

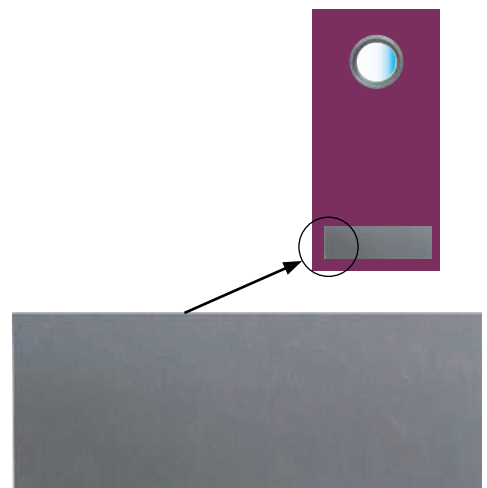
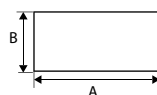



PLACA BOCALLAVE PLP2



Código	8431488	Medida AxB	Acabado				€uros
97825	978253	60x35 mm	LP	-	2	-	
97826	978260	60x35 mm	LS	-	2	-	
97827	978277	60x35 mm	NS	-	2	-	
97828	978284	60x60 mm	LP	-	2	-	
97829	978291	60x60 mm	LS	-	2	-	
97830	978307	60x60 mm	NS	-	2	-	
97831	978314	80x60 mm	LP	-	2	-	
97832	978321	80x60 mm	LS	-	2	-	
97833	978338	80x60 mm	NS	-	2	-	
97810	978109	80x80 mm	LP	-	2	-	
97811	978116	80x80 mm	LS	-	2	-	
97812	978123	80x80 mm	NS	-	2	-	
97813	978130	100x70 mm	LP	-	2	-	
97814	978147	100x70 mm	LS	-	2	-	
97815	978154	100x70 mm	NS	-	2	-	
Blister							
91531	915319	60x35 mm	LP	1	-	10	
91532	915326	60x35 mm	LS	1	-	10	
91533	915333	60x35 mm	NS	1	-	10	
91534	915340	60x60 mm	LP	1	-	10	
91535	915357	60x60 mm	LS	1	-	10	
91536	915364	60x60 mm	NS	1	-	10	
91537	915371	80x60 mm	LP	1	-	10	
91538	915388	80x60 mm	LS	1	-	10	
91539	915395	80x60 mm	NS	1	-	10	
90485	904856	80x80 mm	LP	1	-	10	
90486	904863	80x80 mm	LS	1	-	10	
90487	904870	80x80 mm	NS	1	-	10	
90488	904887	100x70 mm	LP	1	-	10	
90489	904894	100x70 mm	LS	1	-	10	
90490	904900	100x70 mm	NS	1	-	10	



Espesor 1 mm

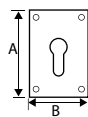

PLACA PISA PUERTA PLP4

Código	8431488	Medida	Acabado				€uros
97842	978420	147x98 mm	LS	-	1	5	

Espesor 5 mm

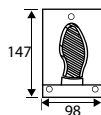

PLACA PISA PUERTA PLP5

Código	8431488	Medida	Acabado				€uros
97843	978437	147x98 mm	LS	-	1	5	
97844	978444	147x98 mm	INOX	-	1	5	
97845	978451	147x98 mm	NE	-	1	5	

Espesor 1 mm

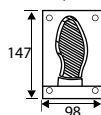

97843: Latón - 97844: Acero Inoxidable - 97845: Acero



ESCUDO SEGURIDAD ES2

	Código	8431488	Medida	Acabado				€uros
Caja	97931	979311	60 mm	LS	-	1	20	
	97932	979328	60 mm	NS	-	1	20	
Blister	91689	916897	60 mm	LS	1	-	10	
	91690	916903	60 mm	NS	1	-	10	

Zamak

Grosor 10 mm

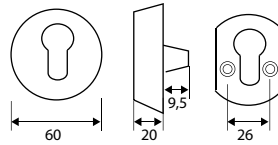

ESCUDO SEGURIDAD ES1

	Código	8431488	Medida	Acabado				€uros
Caja	97941	979410	63 mm	LS	-	1	20	
	97942	979427	63 mm	NS	-	1	20	
Blister	91691	916910	63 mm	LS	1	-	10	
	91692	916927	63 mm	NS	1	-	10	

Zamak

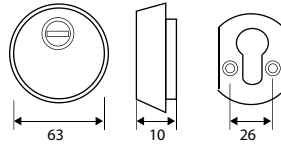

ESCUDO SEGURIDAD ES3

	Código	8431488	Medida	Acabado				€uros
Caja	97943	979434	65 mm	LS	-	1	50	
	97944	979441	65 mm	NS	-	1	50	
Blister	92323	923239	65 mm	LS	1	-	10	
	92324	923246	65 mm	NS	1	-	10	

Acero

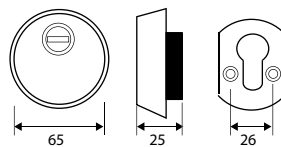

Te sugiero:

BOCALLAVES
Pág. 48-49



MULETILLAS
Pág. 50-51-52





ANTI-BUMPING
ANTI-TALADRO
ANTI-SNAP
ANTI-GANZÚA
DOBLE EMBRAGUE
6 PINES



SEGURIDAD CS1 L15

	Código	843 I 488	Medida AxB	Acabado				€uros
Caja	13174	131740	30x30 mm	LT	-	1	10	
	13175	131757	30x30 mm	NI	-	1	10	
	13176	131764	35x35 mm	LT	-	1	10	
	13177	131771	35x35 mm	NI	-	1	10	
	13178	131788	30x40 mm	LT	-	1	10	
	13179	131795	30x40 mm	NI	-	1	10	
	13180	131801	40x40 mm	LT	-	1	10	
	13181	131818	40x40 mm	NI	-	1	10	
	13182	131825	30x50 mm	LT	-	1	10	
	13183	131832	30x50 mm	NI	-	1	10	
	13184	131849	45x45 mm	LT	-	1	10	
	13185	131856	45x45 mm	NI	-	1	10	
	13186	131863	30x60 mm	LT	-	1	10	
	13187	131870	30x60 mm	NI	-	1	10	
Blister	92190	921907	30x30 mm	LT	1	-	10	
	92191	921914	30x30 mm	NI	1	-	10	
	92192	921921	35x35 mm	LT	1	-	10	
	92193	921938	35x35 mm	NI	1	-	10	
	92194	921945	30x40 mm	LT	1	-	10	
	92195	921952	30x40 mm	NI	1	-	10	

LEVA LARGA

5 Llaves con cabeza de goma

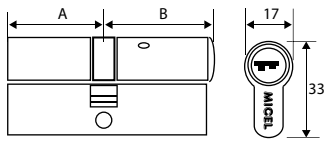

Latón
 LATÓN
 NÍQUEL

CILINDRO SEGURIDAD CS1 L13

	Código	843 I 488	Medida AxB	Acabado				€uros
Caja	13192	131924	30x30 mm	NI	-	1	10	
	13193	131931	35x35 mm	NI	-	1	10	
	13194	131948	30x40 mm	NI	-	1	10	
Blister	92196	921969	30x30 mm	NI	1	-	10	
	92197	921976	35x35 mm	NI	1	-	10	
	92198	921983	30x40 mm	NI	1	-	10	

LEVA CORTA

5 Llaves con cabeza de goma

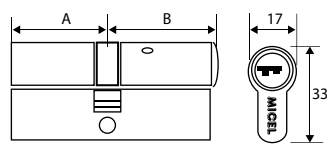

Latón
 NÍQUEL

LLAVE BRUTO CILINDRO CS1

	Código	8431488	Medida	Acabado			€uros
Caja	13195	131955	--	NI	-	10	250

Latón

Llave con cabeza de goma

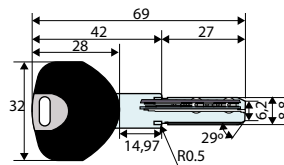

LEVA L13 P/CILINDRO CS1

	Código	8431488	Medida	Acabado			€uros
Caja	13345	133454	L13	NE	-	25	625

Acero

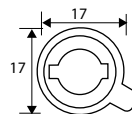

ESTUCHE AMAESTRAMIENTO CILINDRO CS1

	Código	8431488	Medida	Acabado			€uros
Caja	13343	133430	250X190 mm	NA	-	1	-

Plástico

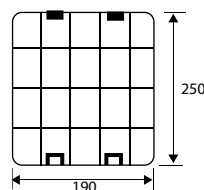

Incluye:

- 1 bolsa muelle inox
- 6 bolsas pitones
- 1 bolsa nuevos pitones
- 5 bolsas suplementos amaestramiento
- 1 bolsa contrapitones
- 1 bolsa pitón interior
- 1 bolsa nuevo contrapitón
- 1 bolsa tapones
- 1 bolsa grapas



ANTI-BUMPING
ANTI-TALADRO

Muelles de Inox
6 pitones de latón

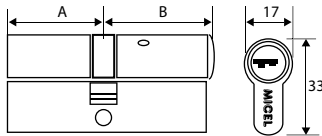

CILINDRO SEGURIDAD CS4 L15

	Código	8431488	Medida AxB	Acabado				€uros
Caja	13304	133041	30x30 mm	LT	-	1	25	
	13305	133058	30x30 mm	NI	-	1	25	
	13306	133065	35x35 mm	LT	-	1	25	
	13307	133072	35x35 mm	NI	-	1	25	
	13308	133089	30x40 mm	LT	-	1	25	
	13309	133096	30x40 mm	NI	-	1	25	
	13310	133102	40x40 mm	LT	-	1	25	
	13311	133119	40x40 mm	NI	-	1	25	
	13312	133126	30x50 mm	LT	-	1	25	
	13313	133133	30x50 mm	NI	-	1	25	
Blister	92236	922362	30x30 mm	LT	1	-	10	
	92237	922379	30x30 mm	NI	1	-	10	
	92238	922386	35x35 mm	LT	1	-	10	
	92239	922393	35x35 mm	NI	1	-	10	
	92240	922409	30x40 mm	LT	1	-	10	
	92241	922416	30x40 mm	NI	1	-	10	

CS4 L15 LLAVES IGUALES GRUPO 1

	Código	8431488	Medida AxB	Acabado				€uros
Caja	13317	133171	30x30 mm	LT	-	1	25	
	13318	133188	30x30 mm	NI	-	1	25	
	13319	133195	35x35 mm	LT	-	1	25	
	13320	133201	35x35 mm	NI	-	1	25	
	13321	133218	30x40 mm	LT	-	1	25	
	13322	133225	30x40 mm	NI	-	1	25	

CS4 L15 LLAVES IGUALES GRUPO 2

	Código	8431488	Medida AxB	Acabado				€uros
Caja	13198	131986	30x30 mm	LT	-	1	25	
	13199	131993	30x30 mm	NI	-	1	25	
	13200	132006	35x35 mm	LT	-	1	25	
	13201	132013	35x35 mm	NI	-	1	25	
	13202	132020	30x40 mm	LT	-	1	25	
	13203	132037	30x40 mm	NI	-	1	25	

CS4 L15 LLAVES IGUALES GRUPO 3

	Código	8431488	Medida AxB	Acabado				€uros
Caja	13207	132075	30x30 mm	LT	-	1	25	
	13208	132082	30x30 mm	NI	-	1	25	
	13209	132099	35x35 mm	LT	-	1	25	
	13210	132105	35x35 mm	NI	-	1	25	
	13211	132112	30x40 mm	LT	-	1	25	
	13212	132129	30x40 mm	NI	-	1	25	

LEVA LARGA

Todas las medidas de cada grupo usan la misma llave



CILINDRO SEGURIDAD CS4 L13

	Código	8431488	Medida AxB	Acabado				€uros
Caja	13314	133140	30x30 mm	NI	-	1	25	
	13315	133157	35x35 mm	NI	-	1	25	
	13316	133164	30x40 mm	NI	-	1	25	
Blister	92242	922423	30x30 mm	NI	1	-	10	
	92243	922430	35x35 mm	NI	1	-	10	
	92244	922447	30x40 mm	NI	1	-	10	

Latón

LEVA CORTA



CS4 L13 LLAVES IGUALES GRUPO 1

	Código	8431488	Medida AxB	Acabado				€uros
Caja	13323	133232	30x30 mm	NI	-	1	25	
	13324	133249	35x35 mm	NI	-	1	25	
	13325	133256	30x40 mm	NI	-	1	25	



ANTI-BUMPING
ANTI-TALADRO

Muelles de Inox
6 pitones de latón

CS4 L13 LLAVES IGUALES GRUPO 2

	Código	8431488	Medida AxB	Acabado				€uros
Caja	13204	132044	30x30 mm	NI	-	1	25	
	13205	132051	35x35 mm	NI	-	1	25	
	13206	132068	30x40 mm	NI	-	1	25	

CS4 L13 LLAVES IGUALES GRUPO 3

	Código	8431488	Medida AxB	Acabado				€uros
Caja	13213	132136	30x30 mm	NI	-	1	25	
	13214	132143	35x35 mm	NI	-	1	25	
	13215	132150	30x40 mm	NI	-	1	25	

Latón

LEVA CORTA



Todas las medidas de cada grupo usan la misma llave

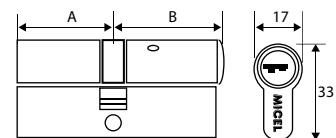



CILINDRO SEGURIDAD CS2 L15

COMPLEMENTOS PUERTA

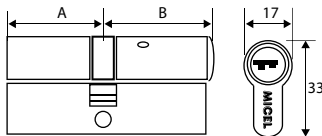

	Código	843 I488	Medida AxB	Acabado				€uros
Caja	13031	130316	30x30 mm	LT	-	1	25	
	13032	130323	30x30 mm	NI	-	1	25	
	13033	130330	35x35 mm	LT	-	1	25	
	13034	130347	35x35 mm	NI	-	1	25	
	13035	130354	30x40 mm	LT	-	1	25	
	13036	130361	30x40 mm	NI	-	1	25	
	13037	130378	40x40 mm	LT	-	1	25	
	13038	130385	40x40 mm	NI	-	1	25	
	13039	130392	30x50 mm	LT	-	1	25	
	13040	130408	30x50 mm	NI	-	1	25	
	13079	130798	45x45 mm	LT	-	1	25	
	13080	130804	45x45 mm	NI	-	1	25	
	13081	130811	30x60 mm	LT	-	1	25	
	13082	130828	30x60 mm	NI	-	1	25	
	13041	130415	40x50 mm	LT	-	1	25	
	13042	130422	40x50 mm	NI	-	1	25	
	13083	130835	50x50 mm	LT	-	1	25	
	13084	130842	50x50 mm	NI	-	1	25	
	13089	130897	40x60 mm	LT	-	1	25	
	13090	130903	40x60 mm	NI	-	1	25	
13091	130910	30x70 mm	LT	-	1	25		
13092	130927	30x70 mm	NI	-	1	25		
13093	130934	60x60 mm	LT	-	1	25		
13094	130941	60x60 mm	NI	-	1	25		
13095	130958	40x80 mm	LT	-	1	25		
13096	130965	40x80 mm	NI	-	1	25		
Blister	91253	912530	30x30 mm	LT	1	-	10	
	91254	912547	30x30 mm	NI	1	-	10	
	91255	912554	35x35 mm	LT	1	-	10	
	91256	912561	35x35 mm	NI	1	-	10	
	91257	912578	30x40 mm	LT	1	-	10	
	91258	912585	30x40 mm	NI	1	-	10	
	91259	912592	40x40 mm	LT	1	-	10	
	91260	912608	40x40 mm	NI	1	-	10	
	91261	912615	30x50 mm	LT	1	-	10	
	91262	912622	30x50 mm	NI	1	-	10	
	91263	912639	40x50 mm	LT	1	-	10	
	91264	912646	40x50 mm	NI	1	-	10	
	91602	916026	45x45 mm	LT	1	-	10	
	91603	916033	45x45 mm	NI	1	-	10	
	91693	916934	30x60 mm	LT	1	-	10	
	91694	916941	30x60 mm	NI	1	-	10	
91695	916958	50x50 mm	LT	1	-	10		
91696	916965	50x50 mm	NI	1	-	10		

LEVA LARGA

Latón



LATÓN



NIQUEL

CS2 L15 LLAVES IGUALES

	Código	8431488	Medida AxB	Acabado				€uros
Caja	13123	131238	30x30 mm	LT	-	1	25	
	13124	131245	30x30 mm	NI	-	1	25	
	13125	131252	35x35 mm	LT	-	1	25	
	13126	131269	35x35 mm	NI	-	1	25	
	13127	131276	30x40 mm	LT	-	1	25	
	13128	131283	30x40 mm	NI	-	1	25	
	13129	131290	40x40 mm	LT	-	1	25	
	13130	131306	40x40 mm	NI	-	1	25	
	13131	131313	30x50 mm	LT	-	1	25	
13132	131320	30x50 mm	NI	-	1	25		

Latón



LEVA LARGA



CILINDRO SEGURIDAD CS2 L13

	Código	8431488	Medida AxB	Acabado				€uros
Caja	13043	130439	30x10 mm	NI	-	1	25	
	13044	130446	40x10 mm	NI	-	1	25	
	13097	130972	30x30 mm	LT	-	1	25	
	13045	130453	30x30 mm	NI	-	1	25	
	13098	130989	35x35 mm	LT	-	1	25	
	13046	130460	35x35 mm	NI	-	1	25	
	13099	130996	30x40 mm	LT	-	1	25	
	13047	130477	30x40 mm	NI	-	1	25	
	13100	131009	40x40 mm	LT	-	1	25	
	13048	130484	40x40 mm	NI	-	1	25	
	13101	131016	30x50 mm	LT	-	1	25	
	13102	131023	30x50 mm	NI	-	1	25	
Blister	91265	912653	30x10 mm	NI	1	-	10	
	91266	912660	40x10 mm	NI	1	-	10	
	91836	918365	30x30 mm	LT	1	-	10	
	91267	912677	30x30 mm	NI	1	-	10	
	91837	918372	35x35 mm	LT	1	-	10	
	91268	912684	35x35 mm	NI	1	-	10	
	91838	918389	30x40 mm	LT	1	-	10	
	91269	912691	30x40 mm	NI	1	-	10	
	91839	918396	40x40 mm	LT	1	-	10	
	91270	912707	40x40 mm	NI	1	-	10	
91840	918402	30x50 mm	LT	1	-	10		
91841	918419	30x50 mm	NI	1	-	10		

Latón



LEVA CORTA

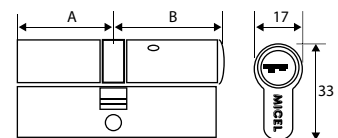

CS2 L13 LLAVES IGUALES

	Código	8431488	Medida AxB	Acabado				€uros
Caja	13133	131337	30x30 mm	NI	-	1	25	
	13134	131344	35x35 mm	NI	-	1	25	
	13135	131351	30x40 mm	NI	-	1	25	
	13136	131368	40x40 mm	NI	-	1	25	
	13137	131375	30x50 mm	NI	-	1	25	

Latón



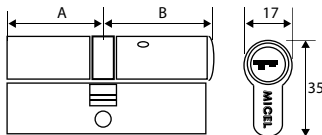

LEVA LARGA

Latón



CILINDRO SERRETA CS3 L15

Código	8431488	Medida AxB	Acabado				€uros
13087	130873	23x23 mm	LT	-	1	25	
13088	130880	23x23 mm	NI	-	1	25	
13103	131030	30x10 mm	LT	-	1	25	
13104	131047	30x10 mm	NI	-	1	25	
13105	131054	40x10 mm	LT	-	1	25	
13106	131061	40x10 mm	NI	-	1	25	
13107	131078	50x10 mm	LT	-	1	25	
13108	131085	50x10 mm	NI	-	1	25	
13109	131092	60x10 mm	LT	-	1	25	
13110	131108	60x10 mm	NI	-	1	25	
13049	130491	30x30 mm	LT	-	1	25	
13050	130507	30x30 mm	NI	-	1	25	
13051	130514	35x35 mm	LT	-	1	25	
13052	130521	35x35 mm	NI	-	1	25	
13053	130538	30x40 mm	LT	-	1	25	
13054	130545	30x40 mm	NI	-	1	25	
13055	130552	40x40 mm	LT	-	1	25	
13056	130569	40x40 mm	NI	-	1	25	
13057	130576	30x50 mm	LT	-	1	25	
13058	130583	30x50 mm	NI	-	1	25	
13085	130859	45x45 mm	LT	-	1	25	
13086	130866	45x45 mm	NI	-	1	25	
13111	131115	30x60 mm	LT	-	1	25	
13112	131122	30x60 mm	NI	-	1	25	
13059	130590	40x50 mm	LT	-	1	25	
13060	130606	40x50 mm	NI	-	1	25	
13113	131139	50x50 mm	LT	-	1	25	
13114	131146	50x50 mm	NI	-	1	25	
13115	131153	40x60 mm	LT	-	1	25	
13116	131160	40x60 mm	NI	-	1	25	
13117	131177	30x70 mm	LT	-	1	25	
13118	131184	30x70 mm	NI	-	1	25	
13119	131191	60x60 mm	LT	-	1	25	
13120	131207	60x60 mm	NI	-	1	25	
13121	131214	40x80 mm	LT	-	1	25	
13122	131221	40x80 mm	NI	-	1	25	

Caja

CS3 L15 LLAVES IGUALES

Código	8431488	Medida AxB	Acabado				€uros
13170	130702	30x10 mm	LT	-	1	25	
13171	131719	30x10 mm	NI	-	1	25	
13069	130699	30x30 mm	LT	-	1	25	
13070	130705	30x30 mm	NI	-	1	25	
13071	130712	35x35 mm	LT	-	1	25	
13072	130729	35x35 mm	NI	-	1	25	
13073	130736	30x40 mm	LT	-	1	25	
13074	130743	30x40 mm	NI	-	1	25	
13138	131382	40x40 mm	LT	-	1	25	
13139	131399	40x40 mm	NI	-	1	25	
13140	131405	30x50 mm	LT	-	1	25	
13141	131412	30x50 mm	NI	-	1	25	

Caja

CILINDRO SERRETA CS3 L15

Código	8431488	Medida AxB	Acabado				€uros
91833	918334	23x23 mm	LT	1	-	10	
91834	918341	23x23 mm	NI	1	-	10	
91842	918426	30x10 mm	LT	1	-	10	
91843	918433	30x10 mm	NI	1	-	10	
91844	918440	40x10 mm	LT	1	-	10	
91845	918457	40x10 mm	NI	1	-	10	
91271	912714	30x30 mm	LT	1	-	10	
91272	912721	30x30 mm	NI	1	-	10	
91273	912738	35x35 mm	LT	1	-	10	
91274	912745	35x35 mm	NI	1	-	10	
91275	912752	30x40 mm	LT	1	-	10	
91276	912769	30x40 mm	NI	1	-	10	
91277	912776	40x40 mm	LT	1	-	10	
91278	912783	40x40 mm	NI	1	-	10	
91279	912790	30x50 mm	LT	1	-	10	
91280	912806	30x50 mm	NI	1	-	10	
91281	912813	40x50 mm	LT	1	-	10	
91282	912820	40x50 mm	NI	1	-	10	
91604	916040	45x45 mm	LT	1	-	10	
91605	916057	45x45 mm	NI	1	-	10	

Blister

Latón



LATÓN



NIQUEL

LEVA LARGA

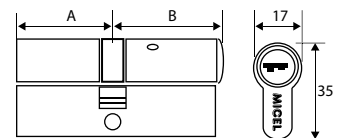

CS3 L15 LLAVES IGUALES

Código	8431488	Medida AxB	Acabado				€uros
92143	921433	30x30 mm	LT	2	-	10	
92144	921440	30x30 mm	NI	2	-	10	
92145	921457	35x35 mm	LT	2	-	10	
92146	921464	35x35 mm	NI	2	-	10	
92147	921471	30x40 mm	LT	2	-	10	
92148	921488	30x40 mm	NI	2	-	10	
92149	921495	40x40 mm	LT	2	-	10	
92150	921501	40x40 mm	NI	2	-	10	

Latón



LATÓN



NIQUEL

LEVA LARGA



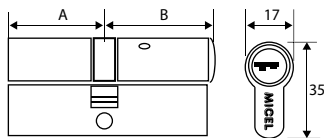

CILINDRO SERRETA CS3 L13

	Código	8431488	Medida AxB	Acabado				€uros
Caja	13061	130613	30x10 mm	NI	-	1	25	
	13062	130620	40x10 mm	NI	-	1	25	
	13144	131443	30x30 mm	LT	-	1	25	
	13063	130637	30x30 mm	NI	-	1	25	
	13145	131450	35x35 mm	LT	-	1	25	
	13064	130644	35x35 mm	NI	-	1	25	
	13146	131467	30x40 mm	LT	-	1	25	
	13065	130651	30x40 mm	NI	-	1	25	
	13147	131474	40x40 mm	LT	-	1	25	
	13066	130668	40x40 mm	NI	-	1	25	
	13148	131481	30x50 mm	LT	-	1	25	
13149	131498	30x50 mm	NI	-	1	25		
Blister	91283	912837	30x10 mm	NI	1	-	10	
	91284	912844	40x10 mm	NI	1	-	10	
	91846	918464	30x30 mm	LT	1	-	10	
	91285	912851	30x30 mm	NI	1	-	10	
	91847	918471	35x35 mm	LT	1	-	10	
	91286	912868	35x35 mm	NI	1	-	10	
	91848	918488	30x40 mm	LT	1	-	10	
	91287	912875	30x40 mm	NI	1	-	10	
	91849	918495	40x40 mm	LT	1	-	10	
	91288	912882	40x40 mm	NI	1	-	10	
	91850	918501	30x50 mm	LT	1	-	10	
91851	918518	30x50 mm	NI	1	-	10		

LEVA CORTA

Latón



CS3 L13 LLAVES IGUALES

	Código	8431488	Medida AxB	Acabado				€uros
Caja	13075	130750	30x10 mm	NI	-	1	25	
	13076	130767	30x30 mm	NI	-	1	25	
	13077	130774	35x35 mm	NI	-	1	25	
	13078	130781	30x40 mm	NI	-	1	25	
	13142	131429	40x40 mm	NI	-	1	25	
	13143	131436	30x50 mm	NI	-	1	25	

LEVA LARGA

Latón



CILINDRO SEGURIDAD POMO CS6 L15

	Código	8431488	Medida AxB	Acabado			€uros
Caja	13150	131504	30x30 mm	LT	-	1	25
	13151	131511	30x30 mm	NS	-	1	25
	13152	131528	35x35 mm	LT	-	1	25
	13153	131535	35x35 mm	NS	-	1	25
	13154	131542	30x40 mm	LT	-	1	25
	13155	131559	30x40 mm	NS	-	1	25
	13156	131566	40x40 mm	LT	-	1	25
	13157	131573	40x40 mm	NS	-	1	25
	13158	131580	30x50 mm	LT	-	1	25
	13159	131597	30x50 mm	NS	-	1	25
Blister	91852	918525	30x30 mm	LT	1	-	10
	91853	918532	30x30 mm	NS	1	-	10
	91854	918549	35x35 mm	LT	1	-	10
	91855	918556	35x35 mm	NS	1	-	10
	91856	918563	30x40 mm	LT	1	-	10
	91857	918570	30x40 mm	NS	1	-	10
	91858	918587	40x40 mm	LT	1	-	10
	91859	918594	40x40 mm	NS	1	-	10
	91860	918600	30x50 mm	LT	1	-	10
	91861	918617	30x50 mm	NS	1	-	10

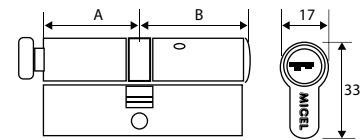

Latón



LEVA LARGA

Pomo siempre en medida A

CILINDRO SERRETA POMO CS7 L15

	Código	8431488	Medida AxB	Acabado			€uros
Caja	13160	131603	30x30 mm	LT	-	1	25
	13161	131610	30x30 mm	NS	-	1	25
	13162	131627	35x35 mm	LT	-	1	25
	13163	131634	35x35 mm	NS	-	1	25
	13164	131641	30x40 mm	LT	-	1	25
	13165	131658	30x40 mm	NS	-	1	25
	13166	131665	40x40 mm	LT	-	1	25
	13167	131672	40x40 mm	NS	-	1	25
	13168	131689	30x50 mm	LT	-	1	25
	13169	131696	30x50 mm	NS	-	1	25
Blister	91862	918624	30x30 mm	LT	1	-	10
	91863	918631	30x30 mm	NS	1	-	10
	91864	918648	35x35 mm	LT	1	-	10
	91865	918655	35x35 mm	NS	1	-	10
	91866	918662	30x40 mm	LT	1	-	10
	91867	918679	30x40 mm	NS	1	-	10
	91868	918686	40x40 mm	LT	1	-	10
	91869	918693	40x40 mm	NS	1	-	10
	91870	918709	30x50 mm	LT	1	-	10
	91871	918716	30x50 mm	NS	1	-	10

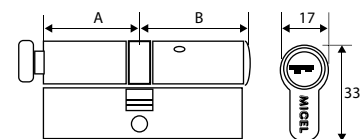

Latón



LEVA LARGA

Pomo siempre en medida A



LLAVES EN BRUTO P/CILINDRO CS2 Y CS3

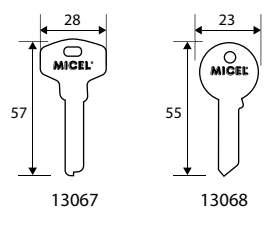

	Código	8431488	Tipo	Acabado				€uros
Caja	13067	130675	seguridad CS2	NI	-	10	250	
	13068	130682	serreta CS3	NI	-	10	250	

Latón

NIQUEL

TORNILLO P/CILINDROS TRN16

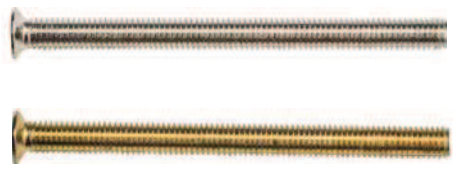

	Código	8431488	Medida A	Acabado				€uros
Caja	13172	131726	M5x65 mm	LTD	-	25	625	
	13173	131733	M5x65 mm	NI	-	25	625	
	13196	131962	M5x85 mm	LTD	-	25	625	
	13197	131979	M5x85 mm	NI	-	25	625	
Blister	92188	921884	M5x65 mm	LTD	4	-	10	
	92189	921891	M5x65 mm	NI	4	-	10	
	92209	922096	M5x85 mm	LTD	4	-	10	
	92210	922102	M5x85 mm	NI	4	-	10	

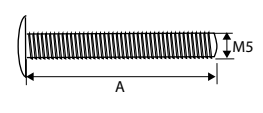

Acero
 LATONADO
 NIQUEL

LEVA L13 P/CILINDRO CS2

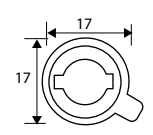

	Código	8431488	Medida	Acabado				€uros
Caja	13003	130033	L13	NE	-	25	625	

Acero
 NEGRO

ADAPTADOR UNIFICADO CERRADURA CS8

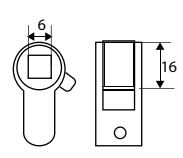
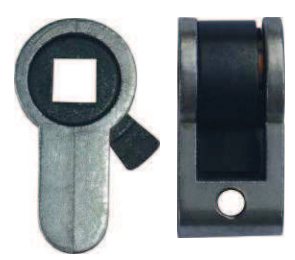

	Código	8431488	Medida	Acabado				€uros
Caja	13002	130026	6 mm	ZN	-	25	250	
Blister	90902	909028	6 mm	ZN	1	-	10	

Acero
 ZINCADO

CERROJO SEGURIDAD SOBREPONER CRR1

	Código	8431488	Medida	Acabado				€uros
Caja	13299	132990	85x74 mm	LTD	-	1	24	
	13300	130003	85x74 mm	NI	-	1	24	

Acero

5 llaves de seguridad

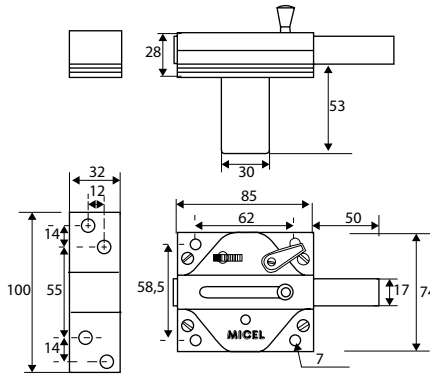
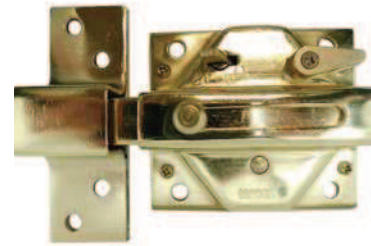

LLAVE BRUTO CERROJO CRR1

	Código	8431488	Tipo	Acabado				€uros
Caja	13365	133652	seguridad	NI	-	10	250	

Latón



CERROJO SEGURIDAD SOBREPONER CRR2

	Código	8431488	Medida	Acabado				€uros
Caja	13301	133010	106x65 mm	PINTADO	-	1	24	

Acero

5 llaves de seguridad

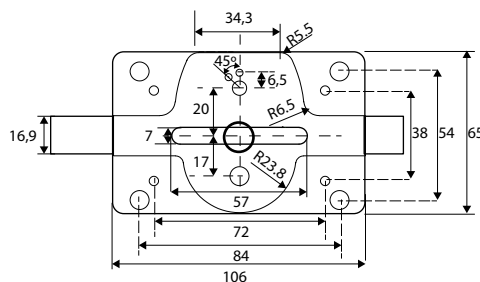

LLAVE BRUTO CERROJO CRR2

	Código	8431488	Tipo	Acabado				€uros
Caja	13366	133669	seguridad	NI	-	10	250	

Latón





VARILLA CUADRADILLO CDD4

	Código	8431488	Medida A	Acabado				€uros
Caja	00692	006925	6x1 mt	ZN	-	5	-	
	00894	008943	8x1 mt	ZN	-	5	-	

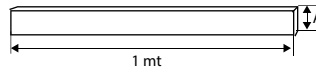

Acero



ZINCADO

CUADRADILLO CDD1

	Código	8431488	Medida Ax B	Acabado				€uros
Caja	00689	006895	6x80 mm	ZN	-	25	100	
	00690	006901	6x90 mm	ZN	-	25	100	
	00691	006918	6x100 mm	ZN	-	25	100	
	00889	008899	8x80 mm	ZN	-	25	100	
	00890	008905	8x90 mm	ZN	-	25	100	
	00891	008912	8x100 mm	ZN	-	25	100	
	00892	008929	8x120 mm	ZN	-	25	50	
	00893	008936	8x150 mm	ZN	-	25	50	
	00888	008882	9x120 mm	BC	-	25	100	
Blister	90114	901145	6x90 mm	ZN	2	-	10	
	90115	901152	8x90 mm	ZN	2	-	10	



Acero



ZINCADO BICROMATADO

CUADRADILLO RANURADO CDD2

	Código	8431488	Medida Ax B	Acabado				€uros
Caja	08103	081038	8x80 mm	ZN	-	25	100	
	08104	081045	8x90 mm	ZN	-	25	100	
	08105	081052	8x100 mm	ZN	-	25	100	
Blister	91629	916293	8x80 mm	ZN	2	-	10	
	91630	916309	8x90 mm	ZN	2	-	10	
	90113	901138	8x100 mm	ZN	2	-	10	



Acero



ZINCADO

CUADRADILLO EXPANSIÓN CDD3

	Código	8431488	Medida Ax B	Acabado				€uros
Caja	00855	008554	8x55 mm	ZN	-	25	100	
	69402	694023	8x65 mm	ZN	-	25	100	
Blister	90663	906638	8x55 mm	ZN	2	-	10	
	90112	901121	8x65 mm	ZN	2	-	10	



Acero



ZINCADO

PLACA CUADRADILLO FIJO CDD5 Y CDD6

	Código	8431488	Tipo/Medida	Acabado				€uros
Caja	69405	694054	cuadradillo/8 mm	ZN	-	25	100	
	69406	694061	espárrago/8 mm	ZN	-	25	100	

Acero

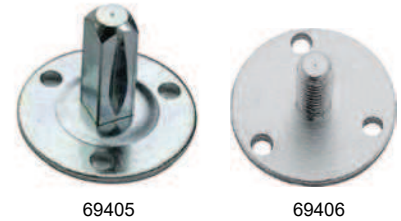
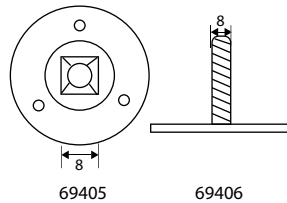

REDUCTOR CUADRADILLO CDD7

	Código	8431488	Medida A - B	Acabado				€uros
Caja	00086	000862	8 - 6 mm	ZN	-	25	100	
Blister	90116	901169	8 - 6 mm	ZN	4	-	10	

Acero

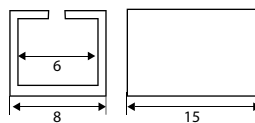

REDUCTOR CUADRADILLO CDD8

	Código	8431488	Medida A - B	Acabado				€uros
Caja	00088	000886	7 - 6 mm	NE	-	25	100	
	00087	000879	8 - 7 mm	NE	-	25	100	
	00089	000893	9 - 8 mm	NE	-	25	100	
Blister	91542	915425	7 - 6 mm	NE	4	-	10	
	91543	915432	8 - 7 mm	NE	4	-	10	
	91544	915449	9 - 8 mm	NE	4	-	10	

Nylon

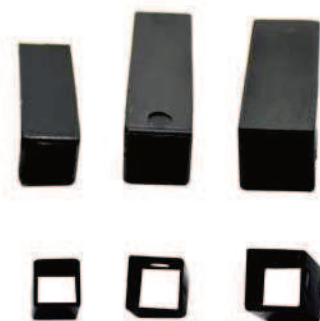
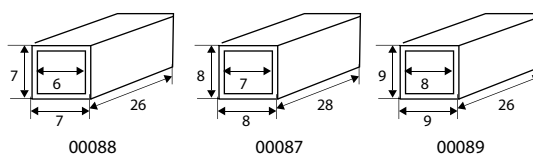



ESCUDO TAPAPOMO REDONDO ES4



	Código	8431488	Medida	Acabado				€uros
Caja	10040	100401	60 mm	LP	-	2	50	
	10241	100418	60 mm	NS	-	2	50	
Blister	90900	909004	60 mm	LP	2	-	10	
	90901	909011	60 mm	NS	2	-	10	

Válido para cubrir el hueco del pomo

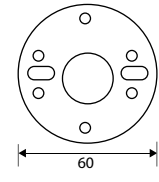

Acero
 LATÓN PULIDO
 NÍQUEL SATINADO



ESCUDO TAPAPOMO CUADRADO ES5



	Código	8431488	Tipo / Medida	Acabado				€uros
Caja	10402	104027	60x60 mm	LP	-	2	-	
	10403	104034	60x60 mm	NS	-	2	-	

Válido para cubrir el hueco del pomo

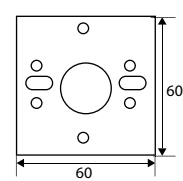

Latón
 LATÓN PULIDO
 NÍQUEL SATINADO

PUNTILLA CABEZA PERDIDA PNT1



	Código	8431488	Medida	Acabado				€uros
Caja	80029	800295	0,9x25 mm	ZN	-	1000	25000	
Blister	90592	905921	0,9x25 mm	ZN	50	-	10	

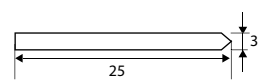

Acero
 ZINCADO

TORNILLO PASANTE TRN1

	Código	8431488	Medida	Acabado			€uros
Caja	40101	401010	M3x55	LTD	-	25	625
	40102	401027	M3x55	NS	-	25	625

Acero

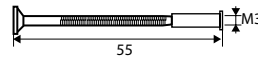

TORNILLO PASANTE MULTICORTE TRN2

	Código	8431488	Medida	Acabado			€uros
Caja	40105	401058	M4x75 mm	LTD	-	25	250
	40106	401065	M4x75 mm	NS	-	25	250
Blister	90664	906645	M4x75 mm	LTD	4	-	10
	90745	907451	M4x75 mm	NS	4	-	10

Acero



Con sistema anti-robo

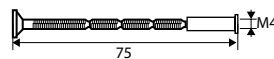

TORNILLO PASANTE TUBO TRN3

	Código	8431488	Medida AxBxC	Acabado			€uros
Caja	40108	401089	M3x60x43 mm	ZN	-	100	2500
	40109	401096	M4x75x32 mm	ZN	-	100	2500
Blister	91540	915401	M3x60x43 mm	ZN	4	-	10
	91541	915418	M4x75x32 mm	ZN	4	-	10

Acero

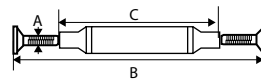

TORNILLO PRISIONERO MANILLA TRN4

	Código	8431488	Medida	Acabado			€uros
Caja	10238	102382	M5x6 mm	INOX	-	25	625
	10255	102559	M6x6 mm	INOX	-	25	625
Blister	92272	922720	M5x6 mm	INOX	10	-	10
	92413	924137	M6x6mm	INOX	10	-	10

Acero Inoxidable

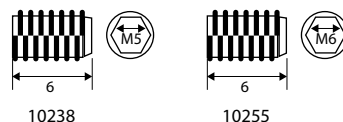



CUÑA DE MADERA PRC4

	Código	8431488	Medida AxBxC	Acabado				€uros
Caja	43575	435756	75x35x10 mm	PINO	-	100	1000	
	43576	435763	250x40x30 mm	PINO	-	100	-	
Blister	90197	901978	75x35x10 mm	PINO	2	-	10	

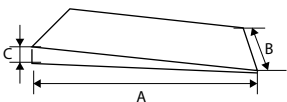
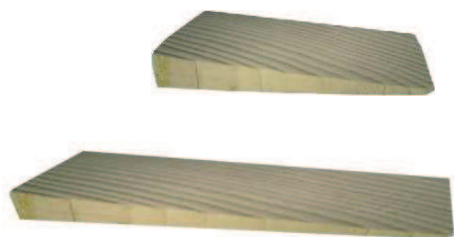

Madera



PINO

ANCLAJE PRECERCO "V" PRC1

	Código	8431488	Medida	Acabado				€uros
Caja	43001	430010	30x30 mm	NE	-	1000	-	

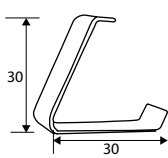

Acero



NEGRO

GARRA PRECERCO PRC2

	Código	8431488	Medida	Acabado				€uros
Caja	43002	430027	140x20 mm	ZN	-	500	-	

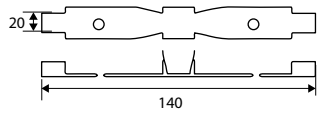

Acero



ZINCADO

GARRA PRECERCO PRC3

	Código	8431488	Medida	Acabado				€uros
Caja	43003	430034	85x17,5 mm	ZN	-	1000	-	
Blister	91159	911595	85x17,5 mm	ZN	10	-	10	

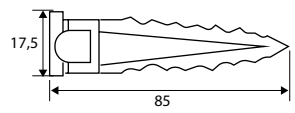

Acero



ZINCADO

BURLETE ADHESIVO PVC BLT1

	Código	8431488	Medida A	Acabado				€uros
Blister	97134	971346	935 mm	BL	1	-	10	
	97136	971360	935 mm	RB	1	-	10	
	97137	971377	935 mm	SAPELI	1	-	10	
	97138	971384	1000 mm	TR	1	-	10	

PVC



Fleco de pelo

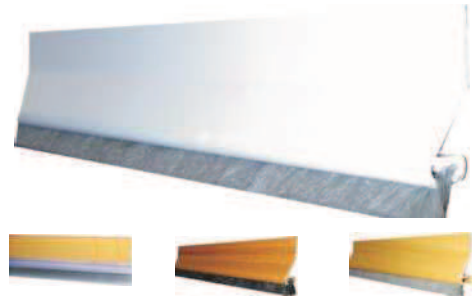
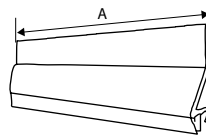

BURLETE ADHESIVO FLECO BLT4

	Código	8431488	Medida	Acabado				€uros
Blister	97121	971216	920 mm	PL	1	-	10	
	97122	971223	920 mm	BL	1	-	10	
	97123	971230	920 mm	SAPELI	1	-	10	
	97124	971247	920 mm	RB	1	-	10	
	97125	971254	920 mm	NE	1	-	10	

Aluminio



Fleco de pelo

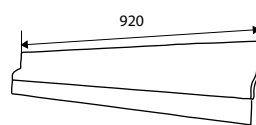

BURLETE ADHESIVO LABIO BLT5

	Código	8431488	Medida	Acabado				€uros
Blister	97126	971261	1050 mm	PL	1	-	10	
	97127	971278	1050 mm	RB	1	-	10	
	97128	971285	1050 mm	SAPELI	1	-	10	
	97129	971292	1050 mm	BL	1	-	10	

Aluminio



Fleco de Goma

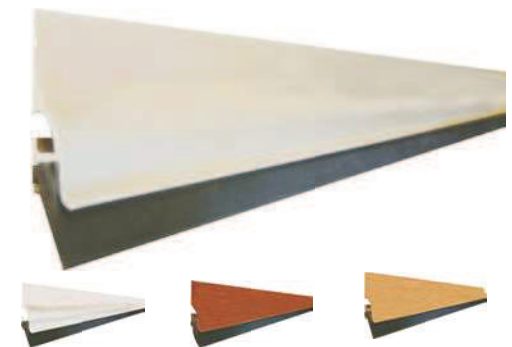
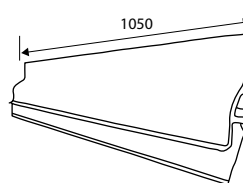

BURLETE ADHESIVO MADERA BLT3

	Código	8431488	Medida	Acabado				€uros
Blister	97147	971476	915 mm	BL	1	-	10	
	97148	971483	915 mm	PINO	1	-	10	
	97149	971490	915 mm	RB	1	-	10	
	97150	971506	915 mm	SAPELI	1	-	10	

Madera



Fleco de fieltro

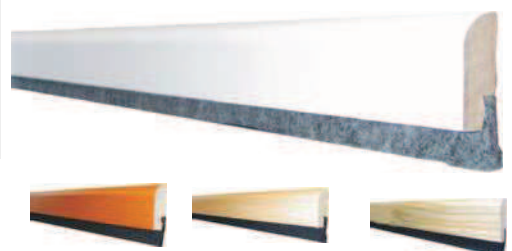
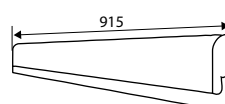



BURLETE BASCULANTE ALUMINIO BLT6

	Código	8431488	Medida	Acabado				€uros
Blister	97130	971308	930 mm	BL	1	-	6	
	97132	971322	930 mm	MA	1	-	6	



Fleco de goma

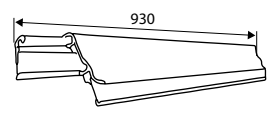

Aluminio



BURLETE AUTOMÁTIC BLT11

	Código	8431488	Medida A	Acabado				€uros
Blister	97186	971865	820 mm	BL	1	-	1	
	97187	971872	920 mm	BL	1	-	1	
	97188	971889	1020 mm	BL	1	-	1	
	97189	971896	820 mm	PL	1	-	1	
	97190	971902	920 mm	PL	1	-	1	
	97191	971919	1020 mm	PL	1	-	1	

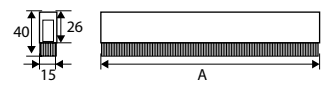

Aluminio



BURLETE BASCULANTE BLT10

	Código	8431488	Medida	Acabado				€uros
	97074	970745	625-825 mm	PL	-	1	-	
	97075	970752	625-825 mm	BL	-	1	-	
	97077	970776	625-825 mm	BR	-	1	-	



Fleco de goma

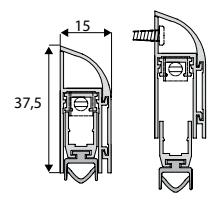

Aluminio



BURLETE EMBUTIR AUTOMÁTICO BLT9

	Código	8431488	Medida A	Acabado				€uros
	97073	970738	625-725 mm	PL	-	1	-	
	97083	970837	725-825 mm	PL	-	1	-	
	97093	970936	825-925 mm	PL	-	1	-	
	97103	971032	925-1025 mm	PL	-	1	-	
	97120	971209	1025-1125 mm	PL	-	1	-	

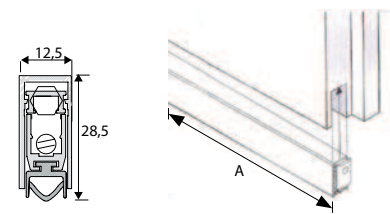

Aluminio



Goma ignífuga

BURLETE BASCULANTE MADERA BLT2

	Código	8431488	Medida A	Acabado				€uros
Blister	97139	971391	815 mm	BL	1	-	10	
	97143	971438	815 mm	RB	1	-	10	
	97145	971452	815 mm	SAPELI	1	-	10	
	97140	971407	915 mm	BL	1	-	10	
	97142	971421	915 mm	PINO	1	-	10	
	97144	971445	915 mm	RB	1	-	10	
	97146	971469	915 mm	SAPELI	1	-	10	

Madera



Fleco de fieltro

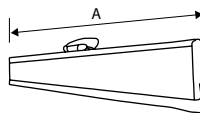

BURLETE GARAJE LABIO BLT7

	Código	8431488	Medida A	Acabado				€uros
Blister	97151	971513	2500 mm	BL	-	6	-	
	97152	971520	2500 mm	PL	-	6	-	
	97153	971537	2500 mm	NE	-	6	-	
	97192	971926	3050 mm	BL	-	6	-	
	97193	971933	3050 mm	PL	-	6	-	
	97194	971940	3050 mm	NE	-	6	-	

Aluminio



Labio de caucho

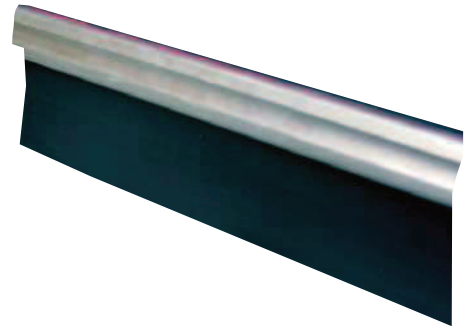
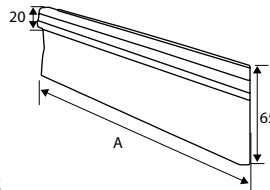

BURLETE GARAJE FLECOS BLT8

	Código	8431488	Medida	Acabado				€uros
Blister	97078	970783	2500 mm	BL	-	6	-	
	97079	970790	2500 mm	PL	-	6	-	
	97080	970806	2500 mm	NE	-	6	-	
	97081	970813	3050 mm	BL	-	6	-	
	97082	970820	3050 mm	PL	-	6	-	
	97084	970844	3050 mm	NE	-	6	-	

Aluminio



Flecos

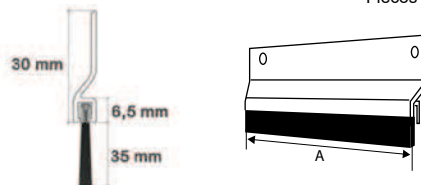

PERFIL PELDAÑO ESCALERA ADHESIVO TJ9

	Código	8431488	Medida A	Acabado				€uros
Blister	97197	971971	2000 mm	OR	-	10	-	
	97198	971988	2000 mm	PL	-	10	-	

Aluminio

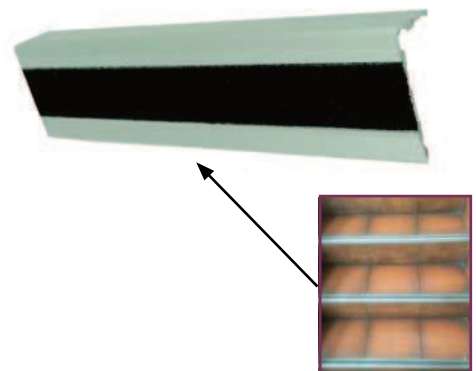



TAPAJUNTAS PLANO ADHESIVO TJ1

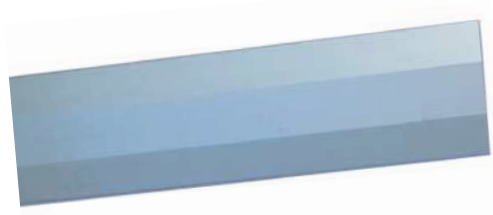

	Código	8431488	Medida A	Acabado				€uros
Blister	97154	971544	830 mm	OR	1	-	40	
	97155	971551	830 mm	PL	1	-	40	
	97158	971582	1000 mm	OR	1	-	40	
	97159	971599	1000 mm	PL	1	-	40	
	97195	971957	2500 mm	OR	-	10	-	
	97196	971964	2500 mm	PL	-	10	-	

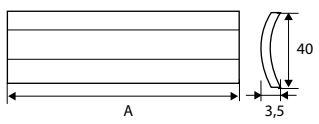

Aluminio
 ORO PLATA

TAPAJUNTAS PLANO TORNILLO TJ2



	Código	8431488	Medida A	Acabado				€uros
Blister	97162	971629	830 mm	OR	1	-	40	
	97163	971636	830 mm	PL	1	-	40	
	97166	971667	1000 mm	OR	1	-	40	
	97167	971674	1000 mm	PL	1	-	40	

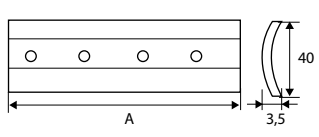

Aluminio
 ORO PLATA

TAPAJUNTAS ESCALÓN ADHESIVO TJ3



	Código	8431488	Medida A	Acabado				€uros
Blister	97170	971704	830 mm	OR	1	-	40	
	97171	971711	830 mm	PL	1	-	40	
	97174	971742	1000 mm	OR	1	-	40	
	97175	971759	1000 mm	PL	1	-	40	

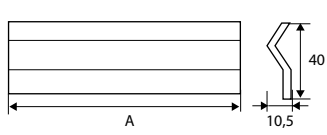

Aluminio
 ORO PLATA

TAPAJUNTAS ESCALÓN TORNILLO TJ4

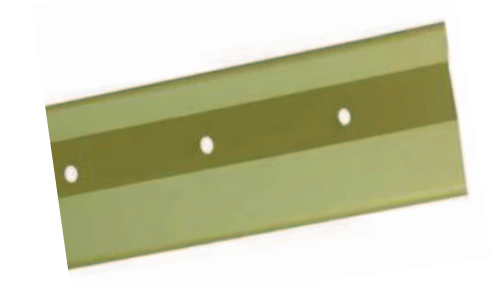

	Código	8431488	Medida A	Acabado				€uros
Blister	97178	971780	830 mm	OR	1	-	40	
	97179	971797	830 mm	PL	1	-	40	
	97182	971827	1000 mm	OR	1	-	40	
	97183	971834	1000 mm	PL	1	-	40	

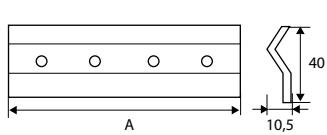

Aluminio
 ORO PLATA

TAPAJUNTAS PLANO ADHESIVO TJ5

	Código	8431488	Medida A	Acabado				€uros
Blister	97156	971568	830 mm	LTD	1	-	40	
	97157	971575	830 mm	INOX	1	-	40	
	97160	971605	1000 mm	LTD	1	-	40	
	97161	971612	1000 mm	INOX	1	-	40	

Acero Inoxidable

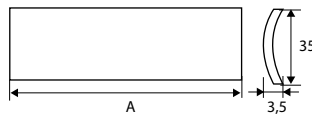

TAPAJUNTAS PLANO TORNILLO TJ6

	Código	8431488	Medida A	Acabado				€uros
Blister	97164	971643	830 mm	LTD	1	-	40	
	97165	971650	830 mm	INOX	1	-	40	
	97168	971681	1000 mm	LTD	1	-	40	
	97169	971698	1000 mm	INOX	1	-	40	

Acero Inoxidable

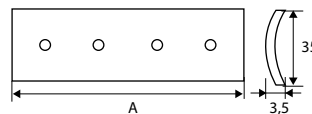

TAPAJUNTAS ESCALÓN ADHESIVO TJ7

	Código	8431488	Medida A	Acabado				€uros
Blister	97172	971728	830 mm	LTD	1	-	40	
	97173	971735	830 mm	INOX	1	-	40	
	97176	971766	1000 mm	LTD	1	-	40	
	97177	971773	1000 mm	INOX	1	-	40	

Acero Inoxidable

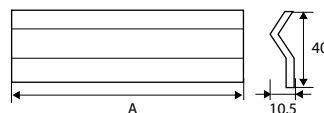

TAPAJUNTAS ESCALÓN TORNILLO TJ8

	Código	8431488	Medida A	Acabado				€uros
Blister	97180	971803	830 mm	LTD	1	-	40	
	97181	971810	830 mm	INOX	1	-	40	
	97184	971841	1000 mm	LTD	1	-	40	
	97185	971858	1000 mm	INOX	1	-	40	

Acero Inoxidable

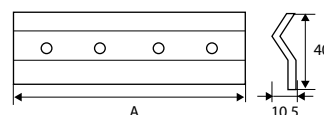



TOPE PUERTA RETENEDOR TP8



	Código	8431488	Medida	Acabado				€uros
Caja	10196	090023	90 mm	INOX	-	1	10	

Acero Inoxidable

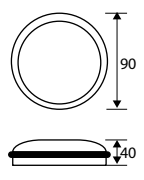

No es necesario atornillar al suelo
Apto para todos los pavimentos
Evita los golpes al abrir y cerrar puertas
Base antideslizante

INOX

TOPE PUERTA CLÁSICO TP9



	Código	8431488	Medida AxBxC	Acabado				€uros
Caja	10229	102290	45x45x20 mm	BL	-	25	125	
	10230	102306	45x45x20 mm	MA	-	25	125	
Blister	91492	914923	45x45x20 mm	BL	2	-	10	
	91493	914930	45x45x20 mm	MA	2	-	10	

Adhesivo

Goma
 BLANCO
 MARRÓN

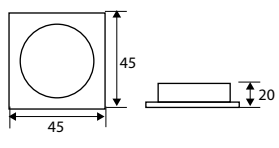

TOPE PUERTA RETENEDOR TP10

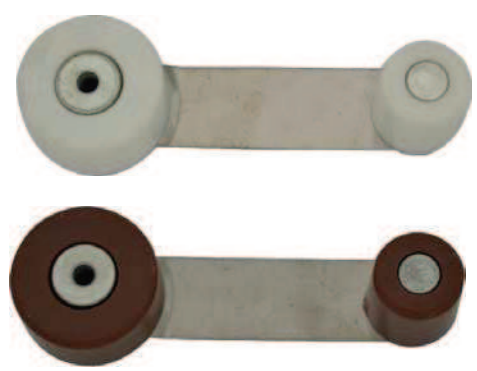

	Código	8431488	Medida	Acabado				€uros
Caja	10227	102276	100x25 mm	BL	-	25	125	
	10228	102283	100x25 mm	MA	-	25	125	
Blister	91494	914947	100x25 mm	BL	1	-	10	
	91495	914954	100x25 mm	MA	1	-	10	

Adhesivo

Goma
 BLANCO
 MARRÓN

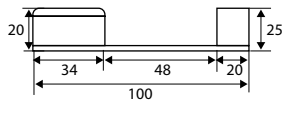

TOPE PUERTA RETENEDOR TP12



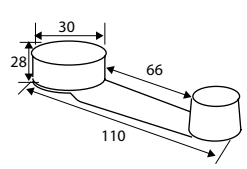

	Código	8431488	Medida	Acabado				€uros
Caja	10237	102375	110x28 mm	INOX	-	10	100	

Acero Inoxidable



INOX

TOPE PUERTA LUX TP1

	Código	843 I 488	Medida	Acabado				€uros
Caja	10020	100203	45 mm	OR	-	25	250	
	10201	102016	45 mm	OM	-	25	250	
	10202	102023	45 mm	CB	-	25	250	
	10203	102030	45 mm	NS	-	25	250	
	10204	102047	45 mm	BL	-	25	250	
	10206	102061	45 mm	CU	-	25	250	
Blister	90125	901251	45 mm	OR	1	-	10	
	90126	901268	45 mm	OM	1	-	10	
	90127	901275	45 mm	CB	1	-	10	
	90128	901282	45 mm	NS	1	-	10	
	90129	901299	45 mm	BL	1	-	10	

Zamak



Taladro

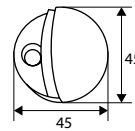

TOPE PUERTA LUX TP2

	Código	843 I 488	Medida	Acabado				€uros
Caja	10210	102108	45 mm	OR	-	25	250	
	10211	102115	45 mm	OM	-	25	250	
	10213	102139	45 mm	NS	-	25	250	
	10231	102313	45 mm	SAPELI	-	25	250	
Blister	90151	901510	45 mm	NS	1	-	10	



Zamak

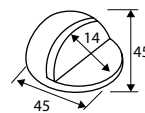

Adhesivo



TOPE PUERTA LUX TP7

	Código	843 I 488	Medida	Acabado				€uros
Caja	10223	102238	47 mm	HAYA	-	25	500	
	10224	102245	47 mm	BL	-	25	500	
	10225	102252	47 mm	SAPELI	-	25	500	
	10226	102269	47 mm	RB	-	25	500	
	10236	102368	47 mm	GR	-	25	500	
Blister	90880	908809	47 mm	HAYA	2	-	10	
	90878	908786	47 mm	BL	2	-	10	
	90879	908793	47 mm	SAPELI	2	-	10	
	90877	908779	47 mm	RB	2	-	10	
	92212	922126	47 mm	GR	2	-	10	

Madera



Adhesivo

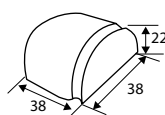



TOPE PUERTA SETA TP6



	Código	8431488	Medida	Acabado				€uros
Caja	10219	102191	32 mm	HAYA	-	25	500	
	10220	102207	32 mm	BL	-	25	500	
	10221	102214	32 mm	SAPELI	-	25	500	
	10222	102221	32 mm	RB	-	25	500	
	10235	102351	32 mm	GR	-	25	500	

Adhesivo

Madera

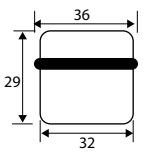

- HAYA
- BLANCO
- SAPELI
- ROBLE
- GRIS

TOPE PUERTA SETA TP3



M4



	Código	8431488	Medida	Acabado				€uros
Caja	10019	100197	20 mm	LP	-	25	125	
	10192	101927	20 mm	CB	-	25	125	
	10193	101934	20 mm	NS	-	25	125	
	10198	101989	20 mm	INOX	-	25	125	
Blister	90133	901336	20 mm	LP	1	-	10	
	90135	901350	20 mm	NS	1	-	10	
	90140	901404	20 mm	INOX	1	-	10	

10019-10192-10193: Latón
10198: Acero Inoxidable
M4

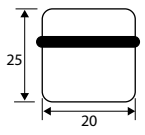

- LATÓN PULIDO
- CROMO BRILLO
- NÍQUEL SATINADO
- INOX

TOPE PUERTA SETA TP4



M4



	Código	8431488	Medida	Acabado				€uros
Caja	10016	100166	20 mm	LTD	-	25	125	
	10017	100173	20 mm	NS	-	25	125	
Blister	91699	916996	20 mm	NS	1	-	10	

Zamak
M4

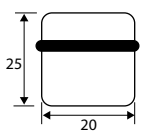

- LATONADO
- NÍQUEL SATINADO

TOPE PUERTA SETA PARQUET TP5



	Código	8431488	Medida	Acabado				€uros
Caja	10199	101996	20 mm	INOX	-	25	125	
Blister	90138	901381	20 mm	INOX	1	-	10	

Acero Inoxidable

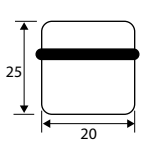

- INOX

TOPE PUERTA STOP TP11

	Código	8431488	Medida	Acabado				€uros
Caja	10232	102320	55 mm	INOX	-	10	50	
Blister	91882	918822	55 mm	INOX	1	-	10	

Acero Inoxidable

Adhesivo

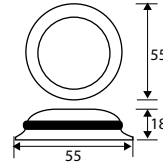

RETENEDOR PUERTA SUELO RT4

	Código	8431488	Medida	Acabado				€uros
Caja	18011	180113	60x30 mm	LTD	-	10	100	
	18012	180120	60x30 mm	CB	-	10	100	
Blister	90144	901442	60x30 mm	LTD	1	-	10	
	90145	901459	60x30 mm	CB	1	-	10	

Zamak

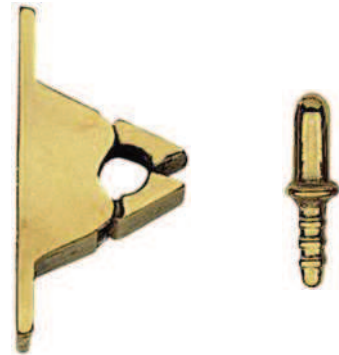
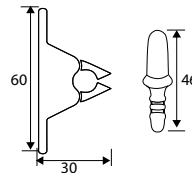

RETENEDOR PUERTA PARED RT5

	Código	8431488	Medida	Acabado				€uros
Caja	18001	180014	60x30 mm	LTD	-	10	100	
	18002	180021	60x30 mm	CB	-	10	100	
Blister	90146	901466	60x30 mm	LTD	1	-	10	
	90147	901473	60x30 mm	CB	1	-	10	

Zamak

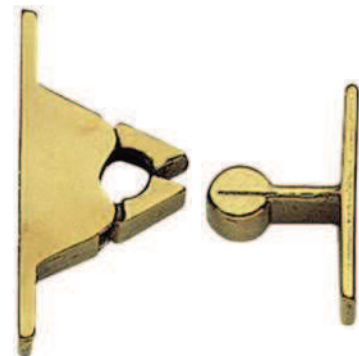
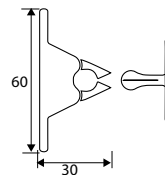

RETENEDOR PUERTA CLIP3

	Código	8431488	Medida	Acabado				€uros
Caja	30520	305202	40x33x36 mm	NE	-	10	50	

Nylon

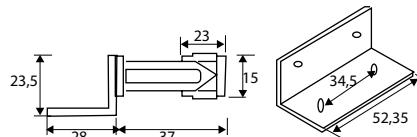



RETENEDOR PIE RT3

	Código	8431488	Medida AxB	Acabado				€uros
Caja	57301	573014	130x25 mm	BL	-	6	30	
	57302	573021	130x25 mm	NE	-	6	30	
	57303	573038	130x25 mm	OR	-	6	30	
	57304	573045	130x25 mm	PL	-	6	30	
	57311	573113	180x30 mm	BL	-	6	30	
	57312	573120	180x30 mm	NE	-	6	30	
	57313	573137	180x30 mm	OR	-	6	30	
	57314	573144	180x30 mm	PL	-	6	30	
Blister	90157	901572	130x25 mm	BL	1	-	10	
	90158	901589	130x25 mm	NE	1	-	10	
	90159	901596	130x25 mm	OR	1	-	10	
	90160	901602	130x25 mm	PL	1	-	10	

130x25 mm = Puertas ligeras (máximo 25 kgs)
 180x30 mm = Puertas de entrada (máximo 40 kgs)

Aluminio

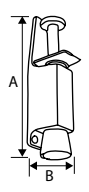

RETENEDOR PUERTA RT1

	Código	8431488	Medida	Acabado				€uros
Blister	30523	305233	108x63 mm	LTD	1	-	10	
	30524	305240	108x63 mm	NS	1	-	10	

Acero

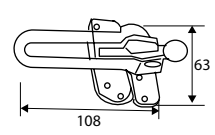

RETENEDOR CADENILLA RT2

	Código	8431488	Medida A	Acabado				€uros
Blister	30503	305035	85x38 mm	LTD	1	-	25	
	30504	305042	85x38 mm	NI	1	-	25	

Acero

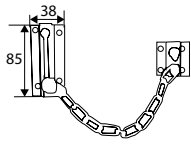

RETENEDOR FORMA "S"

	Código	8431488	Medida	Acabado			€uros
Caja	36025	360256	130x100 mm	NE	-	10	50
Blister	92427	924274	130x100 mm	NE	1	-	10

Acero

Espesor 4 mm



NEGRO

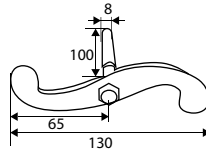

RETENEDOR VENTANA CLIP1

	Código	8431488	Medida	Acabado			€uros
	30518	305189	101 mm	NE	-	4	80
Blister	92232	922324	101 mm	NE	1	-	10

Nylon



NEGRO

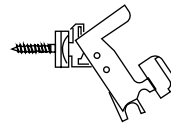
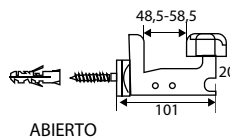
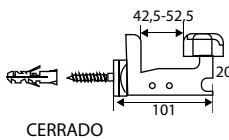

RETENEDOR VENTANA CLIP2

	Código	8431488	Medida	Acabado			€uros
Caja	30519	305196	42x15 mm	NE	-	10	240

Nylon



NEGRO

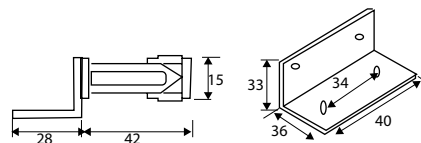

CIERRE VENTANA P/BAJO CV1

	Código	8431488	Medida	Acabado			€uros
Caja	69401	694016	62x44 mm	LT	-	25	125
Blister	90304	903040	62x44 mm	LT	1	-	10

Latón



LATÓN

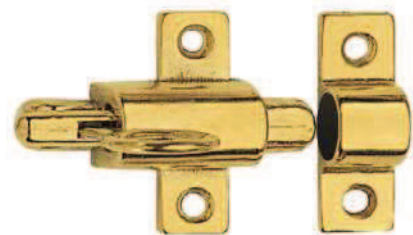
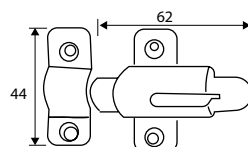



CIERRE PRESIÓN CP1

	Código	8431488	Medida	Acabado				€uros
Caja	51819	518190	PEQUEÑO	INOX	-	4	40	
	51820	518206	GRANDE	INOX	-	4	40	
Blister	92262	922621	PEQUEÑO	INOX	1	-	10	
	92263	922638	GRANDE	INOX	1	-	10	

Reversible

Acero Inoxidable

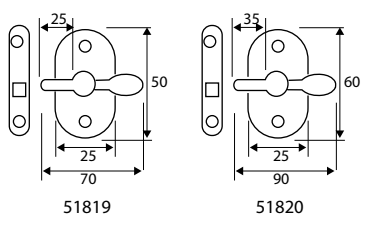

CIERRE PRESIÓN CP2

	Código	8431488	Medida	Acabado				€uros
Caja	51821	518213	105x20 mm	INOX	-	4	40	
Blister	92264	922645	105x20 mm	INOX	1	-	10	

Reversible

Acero Inoxidable

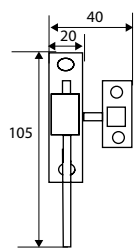

CIERRE PRESIÓN CUCHARA CP3

	Código	8431488	Medida	Acabado				€uros
Caja	51822	518220	60x15 mm	LP	-	1	5	
	51823	518237	60x15 mm	NS	-	1	5	

Reversible

Latón

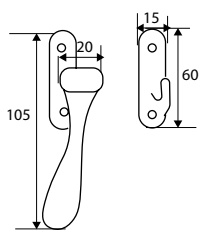

ALDABA REVERSIBLE ADB6

	Código	8431488	Medida	Acabado				€uros
Caja	51817	518176	PEQUEÑA	INOX	-	5	50	
	51818	518183	GRANDE	INOX	-	5	50	
Blister	92260	922607	PEQUEÑA	INOX	1	-	10	
	92261	922614	GRANDE	INOX	1	-	10	

Reversible

Acero Inoxidable

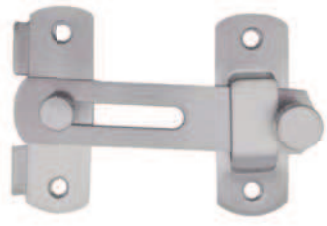
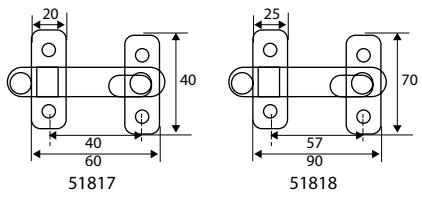

ALDABA CLÁSICA ADB1

	Código	8431488	Medida AxB/Mano	Acabado				€uros
Caja	52401	524016	40x28,5 mm/dcha	LTD	-	12	300	
	52402	524023	40x28,5 mm/izda	LTD	-	12	300	
	52601	526010	60x35 mm/dcha	LTD	-	12	300	
	52602	526027	60x35 mm/izda	LTD	-	12	300	
	52801	528014	80x45 mm/dcha	LTD	-	12	120	
	52802	528021	80x45 mm/izda	LTD	-	12	120	
	51401	514017	40x28,5 mm/dcha	NI	-	12	300	
	51402	514024	40x28,5 mm/izda	NI	-	12	300	
	51601	516011	60x35 mm/dcha	NI	-	12	300	
	51602	516028	60x35 mm/izda	NI	-	12	300	
	51801	518015	80x45 mm/dcha	NI	-	12	120	
	51802	518022	80x45 mm/izda	NI	-	12	120	
Blister	90292	902920	40x28,5 mm/dcha	LTD	1	-	10	
	90293	902937	40x28,5 mm/izda	LTD	1	-	10	
	90294	902944	60x35 mm/dcha	LTD	1	-	10	
	90295	902951	60x35 mm/izda	LTD	1	-	10	
	90296	902968	80x45 mm/dcha	LTD	1	-	10	
	90297	902975	80x45 mm/izda	LTD	1	-	10	
	90298	902982	40x28,5 mm/dcha	NI	1	-	10	
	90299	902999	40x28,5 mm/izda	NI	1	-	10	
	90300	903002	60x35 mm/dcha	NI	1	-	10	
	90301	903019	60x35 mm/izda	NI	1	-	10	
	90302	903026	80x45 mm/dcha	NI	1	-	10	
	90303	903033	80x45 mm/izda	NI	1	-	10	

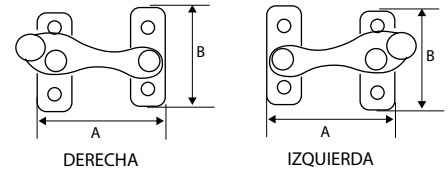

Acero

Incluye tornillos en el blister



ALDABA FORJA ADB4

	Código	8431488	Medida/Mano	Acabado				€uros
Caja	36021	360218	90x80 mm/dcha	NE	-	5	50	
	36022	360225	90x80 mm/izda	NE	-	5	50	
Blister	91518	915180	90x80 mm/dcha	NE	1	-	10	
	91519	915197	90x80 mm/izda	NE	1	-	10	

Acero

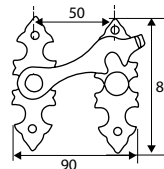

ALDABA FORJA ADB5

	Código	8431488	Medida/Mano	Acabado				€uros
Caja	36023	360232	90x65 mm	NE	-	5	50	
	36024	360249	90x65 mm	NE	-	5	50	
Blister	91520	915203	90x65 mm	NE	1	-	10	
	91521	915210	90x65 mm	NE	1	-	10	

Acero



Reversible

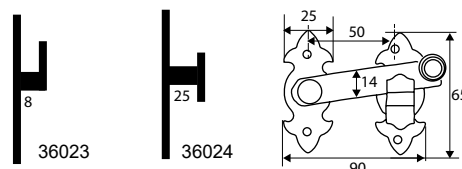



ALDABA CUÑA ADB7



	Código	8431488	Medida AxB	Acabado				€uros
Caja	51824	518244	60 mm	LS	-	4	40	
	51825	518251	60 mm	NS	-	4	40	
	51826	518268	60 mm	NE	-	4	40	
Blister	92371	923710	60 mm	LS	1	-	10	
	92372	923727	60 mm	NS	1	-	10	
	92373	923734	60 mm	NE	1	-	10	

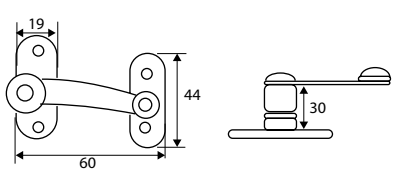

Latón

LATÓN SATINADO
 NÍQUEL SATINADO
 NEGRO

ALDABA BARCO ADB2



	Código	8431488	Medida AxByCxzD	Acabado				€uros
Caja	51808	518084	75x20x28x5,5 mm	LP	-	12	120	
	51809	518091	100x21x27x5,7 mm	LP	-	12	120	
	51810	518107	125x24x32x5,7 mm	LP	-	12	120	
	51811	518114	75x20x28x5,5 mm	NS	-	12	120	
	51812	518121	100x21x27x5,7 mm	NS	-	12	120	
	51813	518138	125x24x32x5,7 mm	NS	-	12	120	
	51814	518145	100x21x27x5,7 mm	NE	-	10	100	
	51815	518152	150x32x45x8 mm	NE	-	6	60	
Blister	91289	912899	75x20x28x5,5 mm	LP	1	-	10	
	91290	912905	100x21x27x5,7 mm	LP	1	-	10	
	91291	912912	125x24x32x5,7 mm	LP	1	-	10	
	91292	912929	75x20x28x5,5 mm	NS	1	-	10	
	91293	912936	100x21x27x5,7 mm	NS	1	-	10	
	91294	912943	125x24x32x5,7 mm	NS	1	-	10	
	91295	912950	100x21x27x5,7 mm	NE	1	-	10	

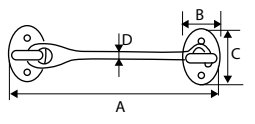

Latón

LATÓN PULIDO
 NÍQUEL SATINADO
 NEGRO

ALDABILLA RETENIDA ADB3



	Código	8431488	Medida AxB	Acabado				€uros
Caja	51803	518039	3x40 mm	ZN	-	50	250	
	51804	518046	3,5x60 mm	ZN	-	50	500	
	51805	518053	4x80 mm	ZN	-	50	500	
	51806	518060	4x100 mm	ZN	-	50	500	
	51807	518077	4,5x120 mm	ZN	-	50	250	
Blister	91191	911915	3x40 mm	ZN	1	-	10	
	91192	911922	3,5x60 mm	ZN	1	-	10	
	91193	911939	4x80 mm	ZN	1	-	10	
	91194	911946	4x100 mm	ZN	1	-	10	

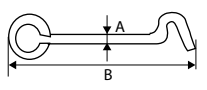

Acero

ZINCADO

PASADOR FORJA PS11

	Código	8431488	Medida AxB	Acabado				€uros
Caja	44146	441467	40x65 mm	NE	-	10	50	
	44147	441474	50x80 mm	NE	-	10	50	
Blister	91516	915166	40x65 mm	NE	1	-	10	
	91517	915173	50x80 mm	NE	1	-	10	

Acero



NEGRO

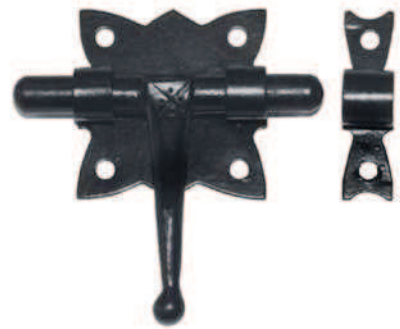
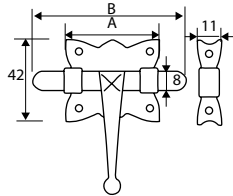

PASADOR PS2

	Código	8431488	Medida A	Acabado				€uros
Blister	44135	441351	35 mm	LTD	1	-	10	
	44235	442358	35 mm	NI	1	-	10	
	44136	441368	35 mm	NS	1	-	10	
	44137	441375	35 mm	CU	1	-	10	
	44138	441382	35 mm	LE	1	-	10	
	44139	441399	35 mm	NE	1	-	10	
	44145	441450	45 mm	LTD	1	-	10	
	44245	442457	45 mm	NI	1	-	10	
	44246	442464	45 mm	NS	1	-	10	

Zamak



Incluye tornillos en el blister

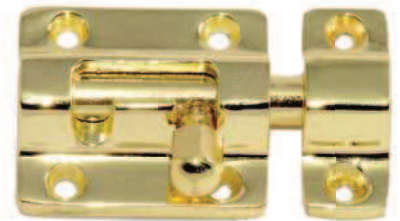
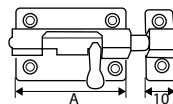

PASADOR ZAMAK PS3

	Código	8431488	Medida	Acabado				€uros
Caja	44635	446356	35 mm	LTD	-	25	250	
	44650	446509	50 mm	LTD	-	25	125	
	44735	447353	35 mm	CB	-	25	250	
	44750	447506	50 mm	CB	-	25	125	
	44633	446332	35 mm	BL	-	25	250	
	44634	446349	50 mm	BL	-	25	125	
Blister	91182	911823	35 mm	LTD	1	-	10	
	91183	911830	50 mm	LTD	1	-	10	
	91184	911847	35 mm	CB	1	-	10	
	91185	911854	50 mm	CB	1	-	10	
	91189	911892	35 mm	BL	1	-	10	
	91190	911908	50 mm	BL	1	-	10	

Zamak



Incluye tornillos en el blister

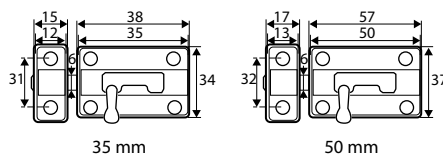



PASADOR HIERRO PS1

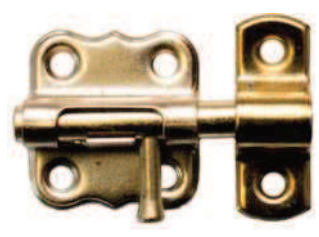

	Código	8431488	Medida AxBxC	Acabado				€uros
Caja	44330	443300	30x13x30 mm	LTD	-	25	250	
	44335	443355	35x13x35 mm	LTD	-	25	250	
	44340	443409	40x20x40 mm	LTD	-	25	250	
	44350	443508	50x25x50 mm	LTD	-	25	250	
	44360	443607	60x30x50 mm	LTD	-	25	250	
	44530	445304	30x13x30 mm	NI	-	25	250	
	44535	445359	35x13x35 mm	NI	-	25	250	
	44540	445403	40x20x40 mm	NI	-	25	250	
	44550	445502	50x25x50 mm	NI	-	25	250	
	44560	445601	60x30x50 mm	NI	-	25	250	
	44570	445700	70x35x55 mm	NI	-	10	120	
	44585	445854	85x42x58 mm	NI	-	10	60	
44510	445106	100x50x58 mm	NI	-	10	60		
Blister	90176	901763	30x13x30 mm	LTD	1	-	10	
	90177	901770	35x13x35 mm	LTD	1	-	10	
	90178	901787	40x20x40 mm	LTD	1	-	10	
	90179	901794	50x25x50 mm	LTD	1	-	10	
	90180	901800	60x30x50 mm	LTD	1	-	10	
	90171	901718	30x13x30 mm	NI	1	-	10	
	90172	901725	35x13x35 mm	NI	1	-	10	
	90173	901732	40x20x40 mm	NI	1	-	10	
	90174	901749	50x25x50 mm	NI	1	-	10	
	90175	901756	60x30x50 mm	NI	1	-	10	
	91188	911885	70x35x55 mm	NI	1	-	10	

Incluye tornillos en el blister

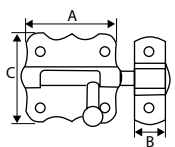

Acero
 LATONADO
 NIQUEL

PASADOR RULETA PS4



	Código	8431488	Medida	Acabado				€uros
Caja	44133	441337	40x56 mm	LTD	-	25	250	
	44134	441344	40x56 mm	CB	-	25	250	
Blister	91600	916002	40x56 mm	LTD	1	-	10	
	91601	916019	40x56 mm	CB	1	-	10	

Incluye tornillos en el blister

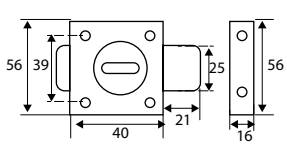

Zamak
 LATONADO
 CROMO BRILLO

PASADOR COLA MILANO PS13

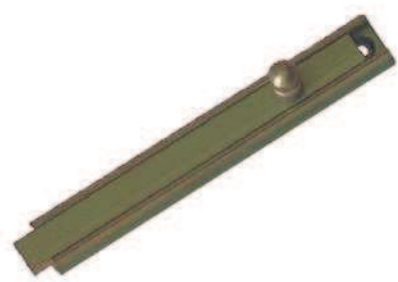

	Código	8431488	Medida AxB	Acabado				€uros
Caja	30150	301501	50x14 mm	LP	-	1	50	
	30160	301600	60x14 mm	LP	-	1	50	

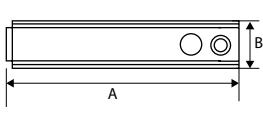

Latón
 LATÓN PULIDO

PORTACANDADO CC10

	Código	8431488	Medida A	Acabado			€uros
Caja	44986	449869	75x40 mm	ZN	-	10	100
	44987	449876	100x40 mm	ZN	-	10	100
	44988	449883	120x40 mm	ZN	-	10	50
	44989	449890	150x40 mm	ZN	-	10	30
	44990	449906	75x40 mm	NE	-	10	100
	44991	449913	100x40 mm	NE	-	10	100
	44992	449920	120x40 mm	NE	-	10	50
	44993	449937	150x40 mm	NE	-	10	30
Blister	91296	912967	75x40 mm	ZN	1	-	10
	91297	912974	100x40 mm	ZN	1	-	10
	91298	912981	120x40 mm	ZN	1	-	10
	91299	912998	75x40 mm	NE	1	-	10
	91300	913001	100x40 mm	NE	1	-	10
	91301	913018	120x40 mm	NE	1	-	10



Acero

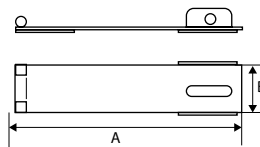

CIERRE ARCÓN CC8

	Código	8431488	Medida AxB	Acabado			€uros
Caja	36018	360188	75x85 mm	NE	-	5	50
	36019	360195	95x110 mm	NE	-	5	50
Blister	91513	915135	75x85 mm	NE	1	-	10
	91514	915142	95x110 mm	NE	1	-	10



Acero

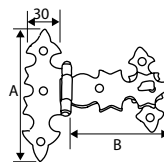

CIERRE ARCÓN CC9

	Código	8431488	Medida	Acabado			€uros
Caja	36020	360201	36x105 mm	NE	-	5	50
Blister	91515	915159	36x105 mm	NE	1	-	10



Acero

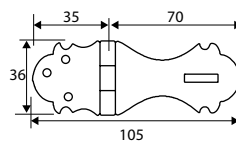

Te sugiero:

PASADORES ALUMINIO - Pág. 76-77



PASADOR PORTACANDADO PS12

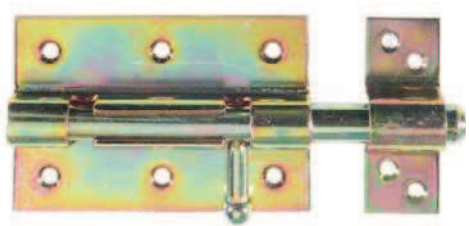

	Código	8431488	Medida AxB	Acabado				€uros
Caja	44970	449708	70x65 mm	BC	-	10	100	
	44985	449852	85x65 mm	BC	-	10	100	
	44910	449104	100x65 mm	BC	-	10	100	
	44912	449128	120x70 mm	BC	-	10	50	
Blister	90181	901817	70x65 mm	BC	1	-	10	
	90182	901824	85x65 mm	BC	1	-	10	

Incluye tornillos en el blister

Acero

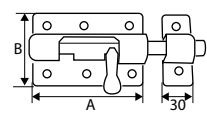

PASADOR SEGURIDAD PS6

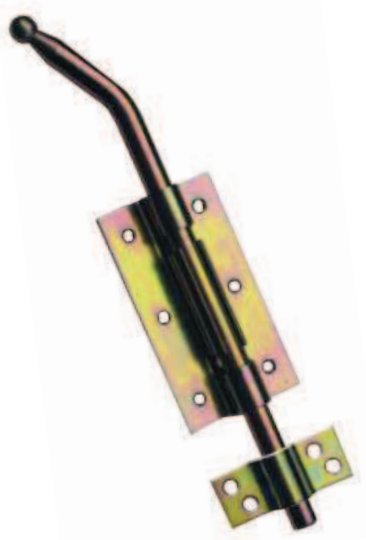

	Código	8431488	Medida AxB	Acabado				€uros
Caja	44020	440200	200x70 mm	BC	-	5	25	
	44025	440255	250x70 mm	BC	-	5	25	
	44030	440309	300x70 mm	BC	-	5	25	
	44040	440408	400x70 mm	BC	-	5	25	
	44050	440507	500x70 mm	BC	-	5	25	
	44060	440606	600x70 mm	BC	-	5	25	

Acero

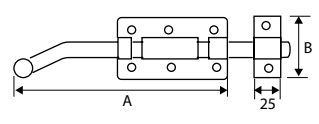

PASADOR LATÓN PS7



	Código	8431488	Medida A	Acabado				€uros
	62120	621203	200 mm	LS	-	1	-	
	62125	621258	250 mm	LS	-	1	-	
	62130	621302	300 mm	LS	-	1	-	
	62140	621401	400 mm	LS	-	1	-	
	62220	622200	200 mm	NS	-	1	-	
	62225	622255	250 mm	NS	-	1	-	
	62230	622309	300 mm	NS	-	1	-	
	62240	622408	400 mm	NS	-	1	-	
	62320	623207	200 mm	CU	-	1	-	
	62325	623252	250 mm	CU	-	1	-	
	62330	623306	300 mm	CU	-	1	-	
	62340	623405	400 mm	CU	-	1	-	

Latón

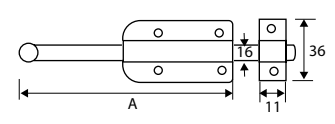

PASADOR EMBUTIR PS8

	Código	8431488	Medida A	Acabado				€uros
Caja	30015	300153	160 mm	LTD	-	24	240	
	30151	301518	160 mm	NS	-	24	240	
	30020	300207	200 mm	LTD	-	24	240	
	30201	302010	200 mm	NS	-	24	240	

Acero
 LATONADO
 NIQUEL SATINADO

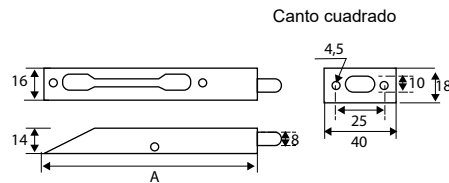

PASADOR EMBUTIR PS9

	Código	8431488	Medida A	Acabado				€uros
Caja	30155	301556	160 mm	LTD	-	24	240	
	30156	301563	160 mm	NS	-	24	240	

Acero
 LATONADO
 NIQUEL SATINADO

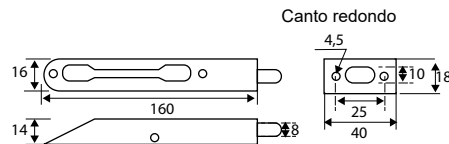

PASADOR EMBUTIR PS10

	Código	8431488	Medida AxB	Acabado				€uros
	30101	301013	152x20 mm	LP	-	1	6	
	30102	301020	200x20 mm	LP	-	1	6	
	30103	301037	305x20 mm	LP	-	1	5	
	30104	301044	152x20 mm	NS	-	1	6	
	30105	301051	200x20 mm	NS	-	1	6	
	30106	301068	305x20 mm	NS	-	1	5	

Latón
 LATÓN PULIDO
 NIQUEL SATINADO

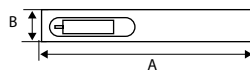

PASADOR 700

	Código	8431488	Medida AxB	Acabado				€uros
Caja	68105	681054	160x25 mm	NI	-	10	50	
	68106	681061	160x25 mm	NI	-	10	50	
	68107	681078	195x25 mm	NI	-	10	50	

Acero
 NIQUEL

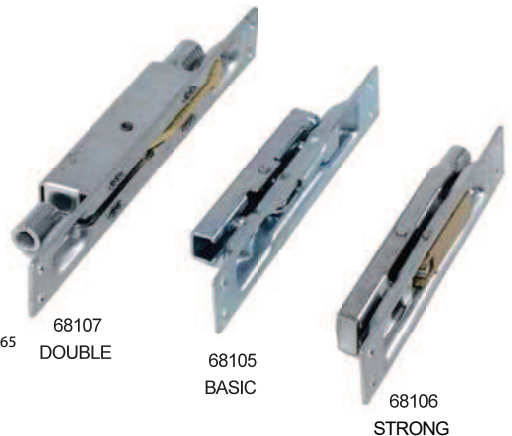
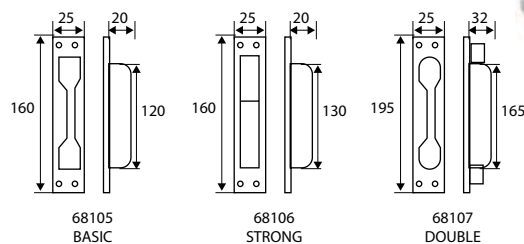

REMATE PASADOR 700

	Código	8431488	Medida	Acabado				€uros
Caja	68108	681085	M8	NI	-	10	250	

Acero
 NIQUEL

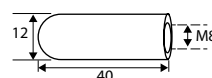



DEDAL EMBUTIR REDONDO DDL1



	Código	8431488	Medida AxB	Acabado				€uros
Caja	64008	640082	8x11,5 mm	LT	-	25	250	
	64010	640105	10x14 mm	LT	-	25	250	
	64012	640129	12x15,5 mm	LT	-	25	250	
	64014	640143	14x17,5 mm	LT	-	25	250	
	64020	640204	20x24 mm	LT	-	25	125	
	64022	640228	22x25,5 mm	LT	-	25	125	
	64108	641089	8x11,5 mm	NI	-	25	250	
	64110	641102	10x14 mm	NI	-	25	250	
	64112	641126	12x15,5 mm	NI	-	25	250	
	64114	641140	14x17,5 mm	NI	-	25	250	
	64120	641201	20x24 mm	NI	-	25	125	
	64122	641225	22x25,5 mm	NI	-	25	125	
Blister	91170	911700	8x11,5 mm	LT	1	-	10	
	91171	911717	10x14 mm	LT	1	-	10	
	91172	911724	12x15,5 mm	LT	1	-	10	
	91173	911731	14x17,5 mm	LT	1	-	10	
	91174	911748	20x24 mm	LT	1	-	10	
	91175	911755	22x25,5 mm	LT	1	-	10	
	91176	911762	8x11,5 mm	NI	1	-	10	
	91177	911779	10x14 mm	NI	1	-	10	
	91178	911786	12x15,5 mm	NI	1	-	10	
	91179	911793	14x17,5 mm	NI	1	-	10	
	91180	911809	20x24 mm	NI	1	-	10	
91181	911816	22x25,5 mm	NI	1	-	10		

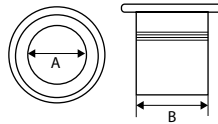

Latón
 LATÓN
 NÍQUEL

DEDAL EMBUTIR CUADRADO DDL2

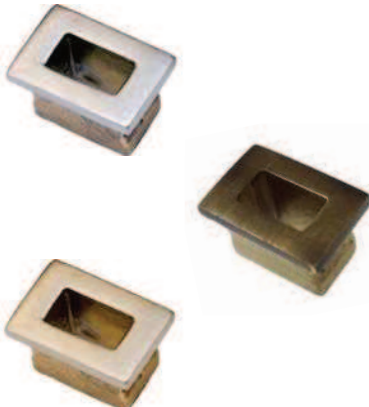

	Código	8431488	Medida	Acabado				€uros
Caja	64006	640068	34x23 mm	LP	-	5	125	
	64007	640075	34x23 mm	NS	-	5	125	
	64005	640051	34x23 mm	CU	-	5	125	
	64004	640044	34x23 mm	NE	-	5	125	

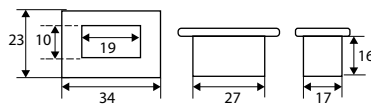

Latón
 LATÓN PULIDO
 NÍQUEL SATINADO
 CUERO
 NEGRO

SOPORTE PASAMANOS 3 TORNILLOS PMN1

	Código	8431488	Medida	Acabado				€uros
Caja	10067	100678	75x52 mm	LP	-	10	100	
	10251	106731	75x52 mm	NS	-	10	100	
	10252	106755	75x52 mm	NE	-	10	100	
Blister	90643	906430	75x52 mm	LP	1	-	10	
	90645	906454	75x52 mm	NS	1	-	10	
	90644	906447	75x52 mm	NE	1	-	10	

Latón

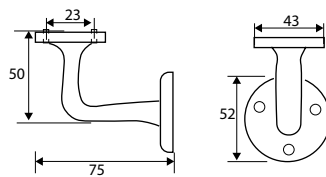

SOPORTE PASAMANOS DOWELL PMN2

	Código	8431488	Medida	Acabado				€uros
Caja	10671	106717	75x52 mm	LP	-	10	100	
	10253	106748	75x52 mm	NS	-	10	100	
	10254	106762	75x52 mm	NE	-	10	100	
Blister	90646	906461	75x52 mm	LP	1	-	10	
	90649	906492	75x52 mm	NS	1	-	10	
	90648	906485	75x52 mm	NE	1	-	10	

Latón



Incluye tornillo Dowel

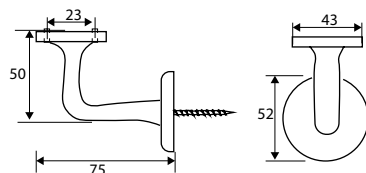

SOPORTE PASAMANOS DOWELL PMN3

	Código	8431488	Medida	Acabado				€uros
	10661	106618	70x70 mm	LTD	-	15	150	
	10663	106632	70x70 mm	NS	-	15	150	
	10662	106625	70x70 mm	NE	-	15	150	
	10664	106649	70x70 mm	CU	-	15	150	

Zamak



Incluye tornillo Dowel
Código de barras individual

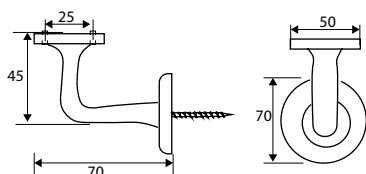



SOPORTE PASAMANOS DOWEL PMN4



	Código	8431488	Medida	Acabado				€uros
Caja	10665	106656	100x50 mm	BC	-	20	-	

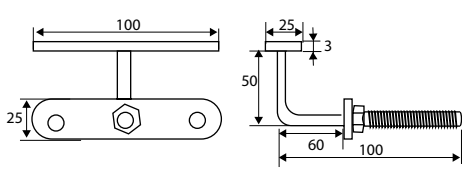

Acero

 BICROMATADO

REMATE BOLA PMN5



	Código	8431488	Medida AxBxC	Acabado				€uros
	10064	100647	43x65x31 mm	LP	-	1	4	
	10065	100654	58x100x35 mm	LP	-	1	4	
	10066	100661	70x120x40 mm	LP	-	1	4	

10064 - M8
 10065 - M10
 10066 - M10

Latón

 LATÓN PULIDO

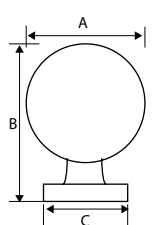

REMATE BELLOTA PMN6



	Código	8431488	Medida AxBxC	Acabado				€uros
	10069	100692	60x110x35 mm	LP	-	1	4	

M10

Latón

 LATÓN PULIDO

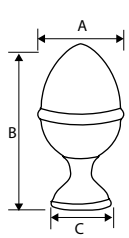

PLACA IDENTIFICATIVA "HOMBRE" PLP6

Código	8431488	Medida	Acabado				€uros
10803	108032	75 mm	INOX	-	1	-	

Acero Inoxidable

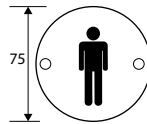

PLACA IDENTIFICATIVA "MUJER" PLP7

Código	8431488	Medida	Acabado				€uros
10804	108049	75 mm	INOX	-	1	-	

Acero Inoxidable

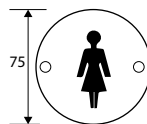

PLACA IDENTIFICATIVA "MINUSVÁLIDO" PLP9

Código	8431488	Medida	Acabado				€uros
10807	108070	75 mm	INOX	-	1	-	

Acero Inoxidable

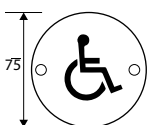

PLACA IDENTIFICATIVA "TOILETTE" PLP8

Código	8431488	Medida	Acabado				€uros
10805	108056	75 mm	INOX	-	1	-	

Acero Inoxidable





Incluye tornillos
Espesor 6 mm

Latón

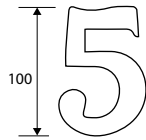

Incluye tornillos
Espesor 6 mm

Latón

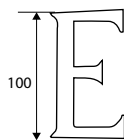



NÚMEROS NM1

	Código	8431488	Medida	Acabado	Modelo				€uros
<i>Blister</i>	10260	102603	100 mm	LP	0	1	-	5	
	10261	102610	100 mm	LP	1	1	-	5	
	10262	102627	100 mm	LP	2	1	-	5	
	10263	102634	100 mm	LP	3	1	-	5	
	10264	102641	100 mm	LP	4	1	-	5	
	10265	102658	100 mm	LP	5	1	-	5	
	10266	102665	100 mm	LP	6-9	1	-	5	
	10267	102672	100 mm	LP	7	1	-	5	
	10268	102689	100 mm	LP	8	1	-	5	
	10300	103006	100 mm	NS	0	1	-	5	
	10301	103013	100 mm	NS	1	1	-	5	
	10302	103020	100 mm	NS	2	1	-	5	
	10303	103037	100 mm	NS	3	1	-	5	
	10304	103044	100 mm	NS	4	1	-	5	
	10305	103051	100 mm	NS	5	1	-	5	
	10306	103068	100 mm	NS	6-9	1	-	5	
	10307	103075	100 mm	NS	7	1	-	5	
	10308	103082	100 mm	NS	8	1	-	5	
	10280	102801	100 mm	NE	0	1	-	5	
	10281	102818	100 mm	NE	1	1	-	5	
	10282	102825	100 mm	NE	2	1	-	5	
	10283	102832	100 mm	NE	3	1	-	5	
	10284	102849	100 mm	NE	4	1	-	5	
	10285	102856	100 mm	NE	5	1	-	5	
	10286	102863	100 mm	NE	6-9	1	-	5	
	10287	102870	100 mm	NE	7	1	-	5	
	10288	102887	100 mm	NE	8	1	-	5	

LETRAS LTR1

	Código	8431488	Medida	Acabado	Modelo				€uros
<i>Blister</i>	10271	102719	100 mm	LP	A	1	-	5	
	10272	102726	100 mm	LP	B	1	-	5	
	10273	102733	100 mm	LP	C	1	-	5	
	10274	102740	100 mm	LP	D	1	-	5	
	10275	102757	100 mm	LP	E	1	-	5	
	10276	102764	100 mm	LP	F	1	-	5	
	10277	102771	100 mm	LP	G	1	-	5	
	10278	102788	100 mm	LP	H	1	-	5	
	10330	103303	100 mm	LP	I	1	-	5	
	10331	103310	100 mm	LP	J	1	-	5	
	10332	103327	100 mm	LP	K	1	-	5	
	10333	103334	100 mm	LP	L	1	-	5	
	10334	103341	100 mm	LP	M	1	-	5	
	10335	103358	100 mm	LP	N	1	-	5	
	10336	103365	100 mm	LP	O	1	-	5	
	10337	103372	100 mm	LP	P	1	-	5	
	10338	103389	100 mm	LP	Q	1	-	5	
	10339	103396	100 mm	LP	R	1	-	5	
	10340	103402	100 mm	LP	S	1	-	5	
	10341	103419	100 mm	LP	T	1	-	5	
	10342	103426	100 mm	LP	U	1	-	5	
	10343	103433	100 mm	LP	V	1	-	5	
	10344	103440	100 mm	LP	W	1	-	5	
	10345	103457	100 mm	LP	X	1	-	5	
	10346	103464	100 mm	LP	Y	1	-	5	
	10347	103471	100 mm	LP	Z	1	-	5	

LETRAS LTR1

Código	8431488	Medida	Acabado	Modelo				€uros
10311	103112	100 mm	NS	A	1	-	5	
10312	103129	100 mm	NS	B	1	-	5	
10313	103136	100 mm	NS	C	1	-	5	
10314	103143	100 mm	NS	D	1	-	5	
10315	103150	100 mm	NS	E	1	-	5	
10316	103167	100 mm	NS	F	1	-	5	
10317	103174	100 mm	NS	G	1	-	5	
10318	103181	100 mm	NS	H	1	-	5	
10366	103662	100 mm	NS	I	1	-	5	
10367	103679	100 mm	NS	J	1	-	5	
10368	103686	100 mm	NS	K	1	-	5	
10369	103693	100 mm	NS	L	1	-	5	
10370	103709	100 mm	NS	M	1	-	5	
10371	103716	100 mm	NS	N	1	-	5	
10372	103723	100 mm	NS	O	1	-	5	
10373	103730	100 mm	NS	P	1	-	5	
10374	103747	100 mm	NS	Q	1	-	5	
10375	103754	100 mm	NS	R	1	-	5	
10376	103761	100 mm	NS	S	1	-	5	
10377	103778	100 mm	NS	T	1	-	5	
10378	103785	100 mm	NS	U	1	-	5	
10379	103792	100 mm	NS	V	1	-	5	
10380	103808	100 mm	NS	W	1	-	5	
10381	103815	100 mm	NS	X	1	-	5	
10382	103822	100 mm	NS	Y	1	-	5	
10383	103839	100 mm	NS	Z	1	-	5	
Bliester								
10291	102917	100 mm	NE	A	1	-	5	
10292	102924	100 mm	NE	B	1	-	5	
10293	102931	100 mm	NE	C	1	-	5	
10294	102948	100 mm	NE	D	1	-	5	
10295	102955	100 mm	NE	E	1	-	5	
10296	102962	100 mm	NE	F	1	-	5	
10297	102979	100 mm	NE	G	1	-	5	
10298	102986	100 mm	NE	H	1	-	5	
10348	103488	100 mm	NE	I	1	-	5	
10349	103495	100 mm	NE	J	1	-	5	
10350	103501	100 mm	NE	K	1	-	5	
10351	103518	100 mm	NE	L	1	-	5	
10352	103525	100 mm	NE	M	1	-	5	
10353	103532	100 mm	NE	N	1	-	5	
10354	103549	100 mm	NE	O	1	-	5	
10355	103556	100 mm	NE	P	1	-	5	
10356	103563	100 mm	NE	Q	1	-	5	
10357	103570	100 mm	NE	R	1	-	5	
10358	103587	100 mm	NE	S	1	-	5	
10359	103594	100 mm	NE	T	1	-	5	
10360	103600	100 mm	NE	U	1	-	5	
10361	103617	100 mm	NE	V	1	-	5	
10362	103624	100 mm	NE	W	1	-	5	
10363	103631	100 mm	NE	X	1	-	5	
10364	103648	100 mm	NE	Y	1	-	5	
10365	103655	100 mm	NE	Z	1	-	5	



A B C D E
 F G H I J K
 L M N O P
 Q R S T U
 V W X Y Z

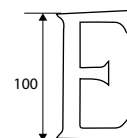

Latón



Incluye tornillos
 Espesor 6 mm



PORTAETIQUETAS PTQ3



	Código	8431488	Medida AxBxCxD	Acabado				€uros
Caja	98510	985107	64x34x45x21 mm	LP	-	10	100	
	98511	985114	85x44x57x27 mm	LP	-	10	100	
	98512	985121	64x34x45x21 mm	NI	-	10	100	
	98513	985138	85x44x57x27 mm	NI	-	10	100	

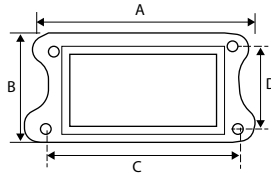

Latón
 LATÓN PULIDO
 NIQUEL

PORTAETIQUETAS PTQ4



	Código	8431488	Medida AxBxCxD	Acabado				€uros
Caja	98514	985145	55x28x41x17 mm	LP	-	10	100	
	98515	985152	77x31x59x18 mm	LP	-	10	100	
	98516	985169	102x58x80x40 mm	LP	-	10	100	
	98517	985176	55x28x41x17 mm	NI	-	10	100	
	98518	985183	77x31x59x18 mm	NI	-	10	100	
	98519	985190	102x58x80x40 mm	NI	-	10	100	

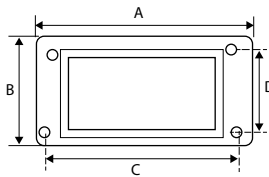

Latón
 LATÓN PULIDO
 NIQUEL

Puertas correderas





KIT PUERTA CORREDERA RÚSTICO PCR1



	Código	8431488	Medida	Acabado				€uros
Caja	55067	550671	2 mts	NE	-	1	-	
	55073	550732	2 mts	BL	-	1	-	
	55071	550718	2 mts	NS	-	1	-	
	55068	550688	2,5 mts	NE	-	1	-	
	55074	550749	2,5 mts	BL	-	1	-	
	55072	550725	2,5 mts	NS	-	1	-	

Carga máxima 80 Kg

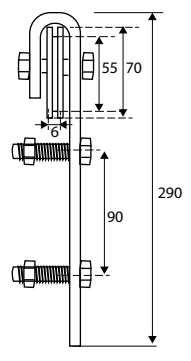

Acero



- Contenido del Kit**
- 1 Pletina (2 o 2,5 mts)
 - 2 Poleas deslizantes
 - 5 Soportes de pared
 - 2 Topes de puerta
 - 2 Tapones antidescarrilamiento
 - 1 Guía inferior
 - 1 Enganche prolongador
 - Tornillería



KIT PUERTA CORREDERA RÚSTICO PCR2

	Código	8431488	Medida	Acabado				€uros
Caja	55069	550695	2 mts	NE	-	1	-	
	55070	550701	2,5 mts	NE	-	1	-	

Carga máxima 80 Kg

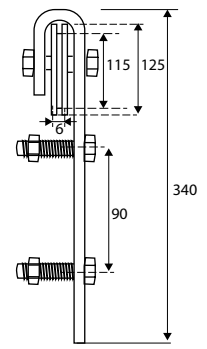

Acero



- Contenido del Kit**
- 1 Pletina (2 o 2,5 mts)
 - 2 Poleas deslizantes
 - 5 Soportes de pared
 - 2 Topes de puerta
 - 2 Enganches Soft-Closing
 - 1 Guía inferior
 - 1 Enganche prolongador
 - Tornillería



Incluye sistema soft-close

JGO TIRADOR REDONDO PCR1

	Código	8431488	Medida	Acabado				€uros
Caja	22122	221229	50 mm	NE	-	1	50	

Acero

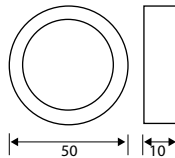

JGO MANILLÓN RECTO PCR1

	Código	8431488	Medida	Acabado				€uros
Caja	22123	221236	180 mm	NE	-	1	20	

Acero

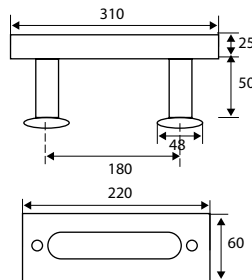

TIRADOR EMBUTIR RECTANGULAR PCR1

	Código	8431488	Medida	Acabado				€uros
Caja	22121	221212	165x54 mm	NE	-	1	50	

Acero

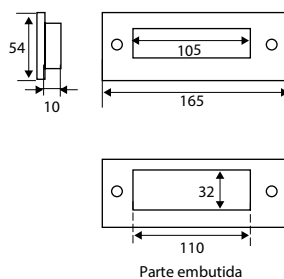



KIT PUERTA CORREDERA PCR6

	Código	8431488	Tipo	Acabado				€uros
Caja	55050	550503	p/cristal	INOX	-	1	5	
	55051	550510	p/madera	INOX	-	1	10	

Capacidad de carga de cristal: 150 kgs
No incluye el tubo

Acero Inoxidable



Contenido kit puerta de madera

1 Jgo. sujeción y rodamiento puerta 3 Soportes Tubo pared

1 Jgo. tope puerta 2 Tapones final de tubo 1 Guia carril inferior

Contenido kit puerta de cristal

1 Jgo. sujeción y rodamiento puerta 3 Soportes Tubo pared 1 Jgo. Tirador de embutir

1 Jgo. tope puerta 2 Tapones final de tubo 1 Guia carril inferior



Presentación embalaje deluxe



SOPORTE TUBO PARED LATERAL PCR6

	Código	8431488	Medida	Acabado				€uros
Caja	55052	550527	ø 25 mm	INOX	-	1	25	

Incluye tornillo, taco metálico y llave allen

Acero Inoxidable

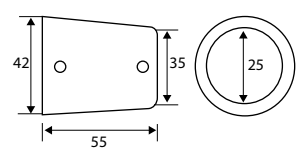

SOPORTE TUBO PARED FRONTAL PCR6

	Código	8431488	Medida	Acabado				€uros
	55066	550664	ø 25 mm	INOX	-	1	10	

Incluye tornillo y taco metálico

Acero Inoxidable

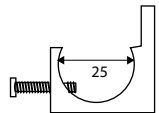

TUBO CORREDERA ø25 PCR6

	Código	8431488	Medida A	Acabado				€uros
	55060	550602	2 mts	INOX	-	1	-	
	55053	550534	3 mts	INOX	-	1	-	
	55061	550619	4 mts	INOX	-	1	-	

Espesor 2,5 mm

Acero Inoxidable

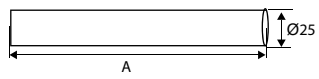

PERFIL GUÍA PCR7

	Código	8431488	Medida A	Acabado				€uros
	55056	550565	1,5 mts	AL	-	1	5	
	55057	550572	2 mts	AL	-	1	5	
	55058	550589	3 mts	AL	-	1	5	
	55059	550596	4 mts	AL	-	1	5	

Aluminio

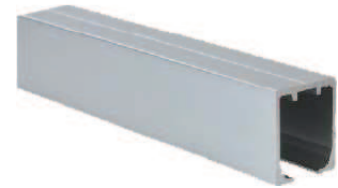
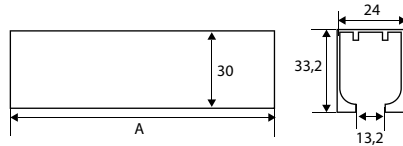

JGO ACCESORIOS P/MADERA PCR8

	Código	8431488	Peso	Acabado				€uros
Caja	55055	550558	80 KGS	RO/GR	-	1	10	

ABS



Válido para el perfil guía aluminio y premarcos
Tornillo M8
Incluye tornillos de fijación

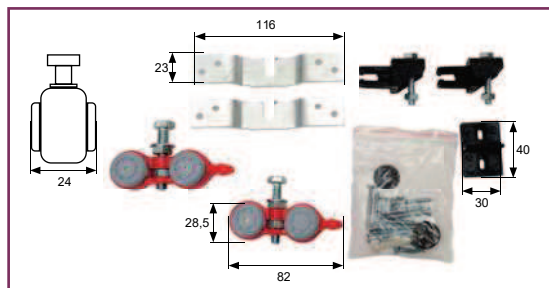

POLEA GUÍA 698

	Código	8431488	Medida AxBxC	Acabado				€uros
	68100	681009	30x30x70 mm	BL	-	1	12	
	68101	681016	35x35x110 mm	BL	-	1	6	
	68102	681023	40x40x80 mm	BL	-	1	6	

Nylon

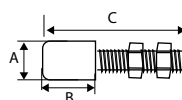



POLIPELO PCR9



Código	8431488	Medida	Acabado				€uros
	55103	551036	12x2150 mm	BL	-	1	10
	55104	551043	12x2150 mm	NE	-	1	10
	55105	551050	12x2150 mm	RB	-	1	10

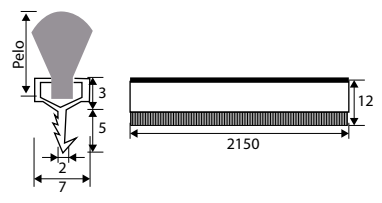

Sintético

BLANCO
 NEGRO
 ROBLE

JUNTA MARCO PCR10

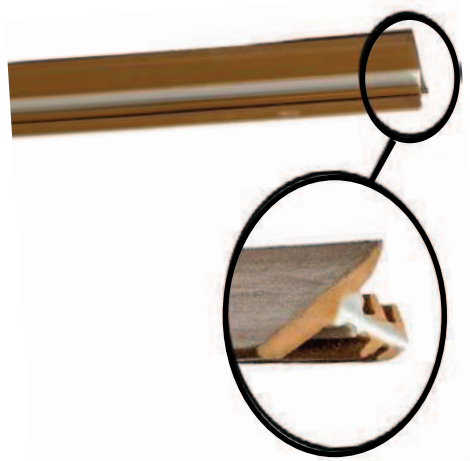

Código	8431488	Medida	Acabado				€uros
	55107	551074	2150 mm	BL	-	1	10
	55108	551081	2150 mm	NE	-	1	10
	55109	551098	2150 mm	RB	-	1	10

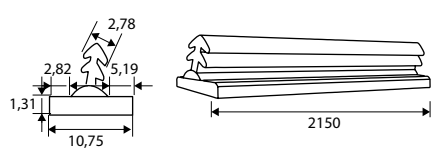

Goma

BLANCO
 NEGRO
 ROBLE



Te sugiero:



KIT PUERTA CORREDERA
Pág. 170 - 171



TIRADORES
Pág. 209



CERRADURA PICOLORO
Pág. 172



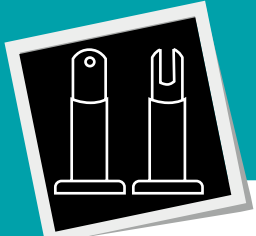

MULETILLA CORREDERA CB21

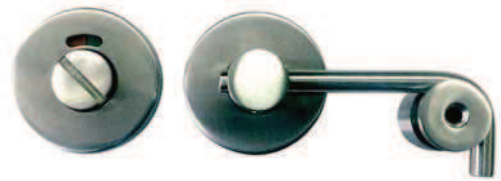

Código	8431488	Medida	Acabado				€uros
54522	545226	118x50 mm	INOX	-	1	50	

Incluye tornillos
Cuadradillo 6 mm

Acero Inoxidable

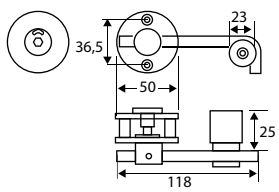

MULETILLA MINUSVÁLIDO CB11



Código	8431488	Medida	Acabado				€uros
10097	100975	50 mm	INOX	-	1	5	

Incluye tornillos
Cuadradillo 6 mm

Acero Inoxidable



MULETILLA ROSETA C/INDICADOR CB1



Código	8431488	Medida	Acabado				€uros
54501	545011	63 mm	INOX	-	1	5	

AISI 316							
Código	8431488	Medida	Acabado				€uros
54568	545684	63 mm	INOX	-	1	5	

Incluye tornillos
Cuadradillo 6 mm

54501: Acero Inoxidable
54568: Acero inoxidable AISI 316

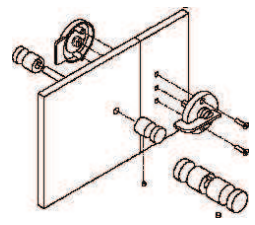
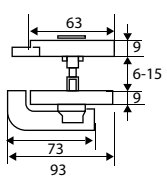

JGO POMOS CB4



Código	8431488	Medida	Acabado				€uros
54504	545042	25 mm	INOX	-	1	10	

M10
Incluye llave allen

Acero Inoxidable

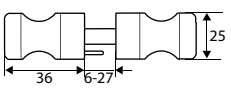

Válido para tablero fenólico de 13 mm

BISAGRA PLANA S/MUELLE CB2

Código	8431488	Medida	Acabado				€uros
54502	545028	90x52 mm	INOX	-	1	10	

Acero Inoxidable



Espesor 2 mm

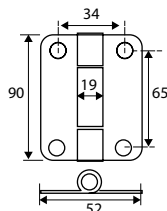

BISAGRA PLANA C/MUELLE CB3

Código	8431488	Medida	Acabado				€uros
54503	545035	90x52 mm	INOX	-	1	10	

Acero Inoxidable



Incluye llave allen
Espesor 2 mm

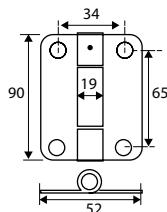

BISAGRA PLANA C/MUELLE CB26

Código	8431488	Medida	Acabado				€uros
54526	545264	77x76 mm	INOX	-	1	6	

Acero Inoxidable



Incluye tapas embelleecedoras, llave allen y tornillos
Espesor 2 mm

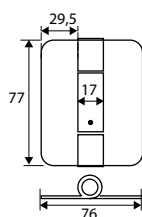

BISAGRA TAQUILLA CB28

Código	8431488	Medida	Acabado				€uros
54570	545707	77x67 mm	INOX	-	1	20	

Acero Inoxidable



Espesor 2 mm

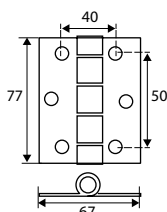

Válido para tablero fenólico de 13 mm



Te sugiero:

CERRADURA C/COMBINACIÓN
Pág. 245



CERRADURA TAQUILLA
Pág. 241



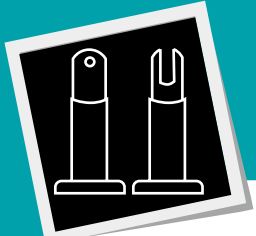

PATA REGULABLE CB10



Código	8431488	Medida	Acabado				€uros
54510	545103	110/180 mm	INOX	-	1	5	
54566	545660	210/370 mm	INOX	-	1	5	

AISI 316							
Código	8431488	Medida	Acabado				€uros
54567	545677	110/180 mm	INOX	-	1	5	

54510-54566: Acero Inoxidable
54567: Acero inoxidable AISI 316

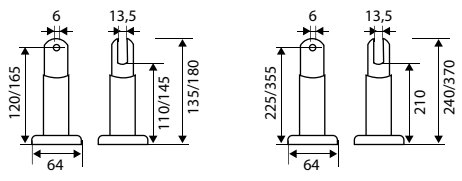

54567-54510 54566

INOX

PERCHA TOPE GOMA PER18



Código	8431488	Medida	Acabado				€uros
54513	545134	50x70 mm	INOX	-	1	10	

Incluye tornillos Acero Inoxidable

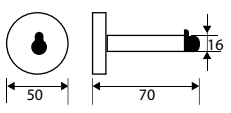

INOX

PINZA UNIÓN TUBO PANEL CB7



Código	8431488	Medida	Acabado				€uros
54507	545073	32,5x110 mm	INOX	-	1	10	

Incluye tornillos
Espesor 3 mm Acero Inoxidable

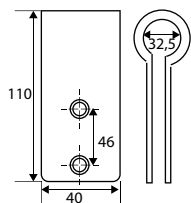

INOX

Válido para tablero fenólico de 13 mm

Te sugiero:

PERCHAS

Pág. 336-337-338

SOPORTE TUBO PARED CB5

Código	8431488	Medida	Acabado				€uros
54505	545059	65 mm	INOX	-	1	10	

Acero Inoxidable

Incluye tornillos

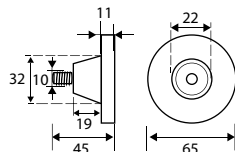

NUDO CONECTOR TUBO CB6

Código	8431488	Tipo - Medida	Acabado				€uros
54506	545066	2 agujeros (90°) - 44 mm	INOX	-	1	10	
54511	545110	3 agujeros (180°) - 44 mm	INOX	-	1	10	

Acero Inoxidable

Incluye llave allen

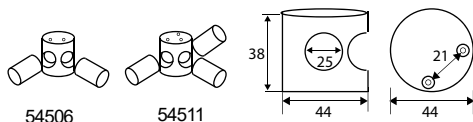

ÁNGULO CONECTOR TUBO CB27

Código	8431488	Medida	Acabado				€uros
54569	545691	25 mm	INOX	-	1	10	

Acero Inoxidable

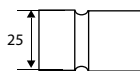

EMPALME UNIÓN TUBO CB20

Código	8431488	Medida	Acabado				€uros
54520	545202	25 mm	INOX	-	1	10	

Acero Inoxidable

Incluye llave allen

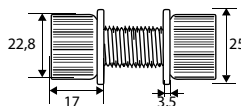

TUBO CABINA CB9

Código	8431488	Medida A	Acabado				€uros
54509	545097	Ø25x2 mts	INOX	-	1	-	
54519	545196	Ø25x3 mts	INOX	-	1	-	

Acero Inoxidable

Espesor 1,5 mm

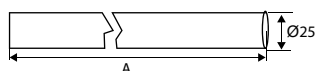

Válido para tablero fenólico de 13 mm

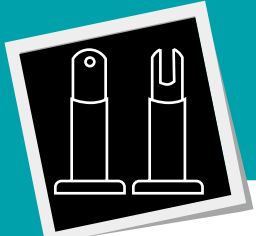

ESCUADRA 90° UNIÓN PANEL CB8



Código	8431488	Medida	Acabado				€uros
54508	545080	43,5x40 mm	INOX	-	1	20	

Incluye tornillos
Espesor 3 mm

Acero Inoxidable

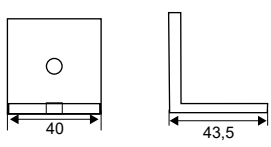

PINZA UNIÓN LATERAL CB12



Código	8431488	Medidas	Acabado				€uros
54512	545127	50x50 mm	INOX	-	1	10	

Incluye tornillos
Espesor 2 mm

Acero Inoxidable

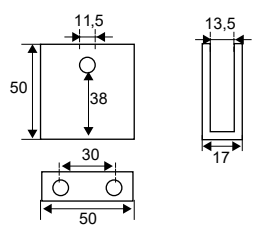

PINZA ESCUADRA UNIÓN "TU" CB17



Código	8431488	Medidas	Acabado				€uros
54517	545172	50x50 mm	INOX	-	1	10	

Incluye tornillos
Espesor 2 mm

Acero Inoxidable

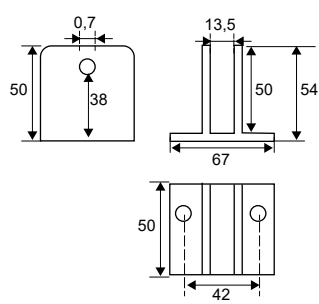

PINZA ESCUADRA UNIÓN "LU" CB18



Código	8431488	Medida	Acabado				€uros
54518	545189	50x50 mm	INOX	-	1	10	

Incluye tornillos
Espesor 2 mm

Acero Inoxidable

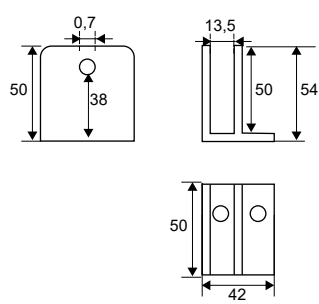

Válido para tablero fenólico de 13 mm

PERFILES CABINA INOX CB13/ CB14/ CB15

Código	8431488	Tipo - Medida	Acabado				€uros
54514	545141	"L" interior - 1800 mm	INOX	-	1	-	
54515	545158	"L" exterior - 1800 mm	INOX	-	1	-	
54516	545165	"U" arranque - 1800 mm	INOX	-	1	-	

Acero Inoxidable

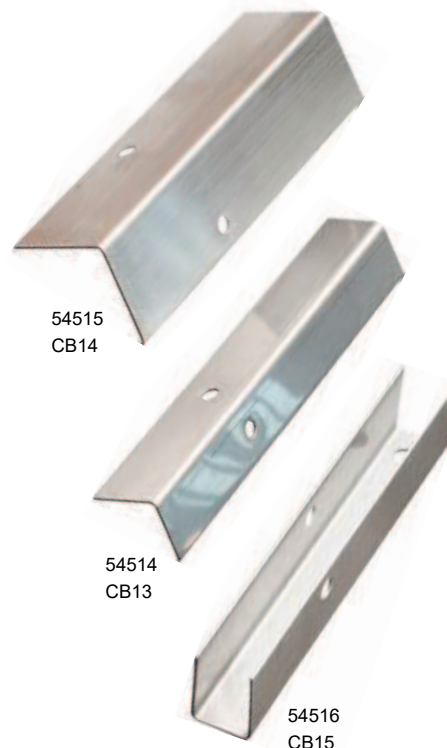
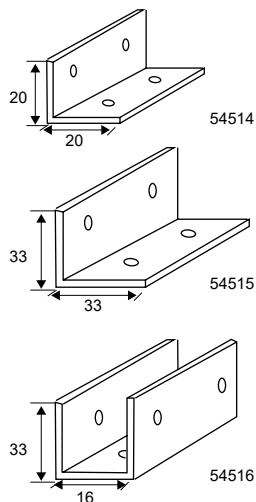
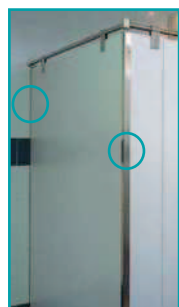

PERFILES CABINA ALUMINIO CB19/CB15/CB16

Código	8431488	Tipo - Medida	Acabado				€uros
54524	545240	Superior - 3950 mm	AL	-	1	10	
54525	545257	"U" arranque - 1800 mm	AL	-	1	20	
54565	545653	Esquinero - 1800 mm	AL	-	1	10	

Aluminio

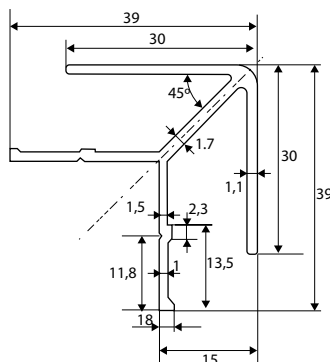
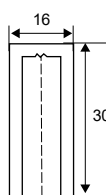
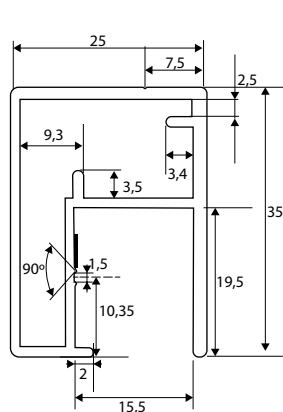

54524



54525

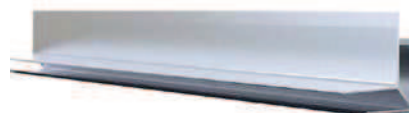

54565

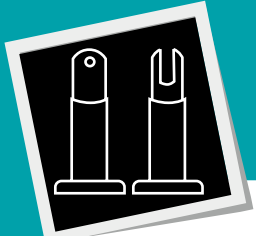

KIT CABINA SANITARIA CORREDERA CB21



	Código	8431488	Medida	Acabado				€uros
Caja	54521	545219	-	INOX	-	1	10	

Acero Inoxidable

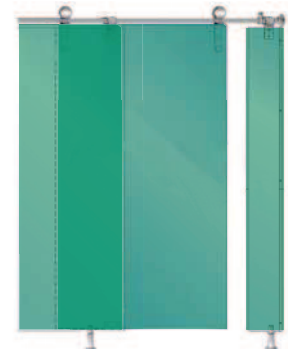
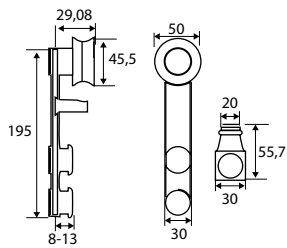

GUÍA INFERIOR CORREDERA CB21



	Código	8431488	Medida	Acabado				€uros
	54523	545233	50x37 mm	INOX	-	1	5	

Incluye tornillos

Acero Inoxidable

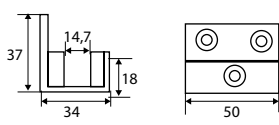

TORNILLO PERFILES Y BISAGRAS CABINA CB25



	Código	8431488	Medidas A	Acabado				€uros
Caja	40111	401119	3,5x12,5 mm	INOX	-	100	2.500	
	40107	401072	3,5x14 mm	INOX	-	100	2.500	

Acero Inoxidable

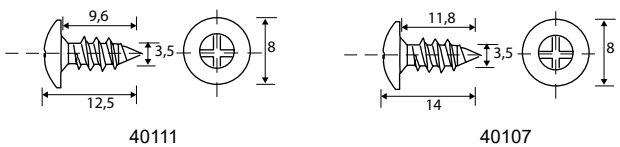

TORNILLO PASANTE CABINA CB22/CB23/CB24



	Código	8431488	Medida A	Acabado				€uros
Caja	40103	401034	12,5 - 18 mm	INOX	-	100	2.500	
	40104	401041	12 - 16 mm	INOX	-	100	2.500	
	40110	401102	18 - 21 mm	INOX	-	100	2.500	

Acero Inoxidable

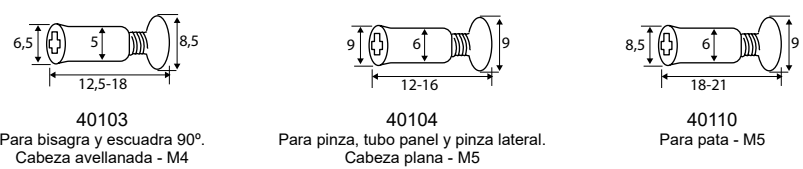

40103
Para bisagra y escuadra 90°. Cabeza avellanada - M4

40104
Para pinza, tubo panel y pinza lateral. Cabeza plana - M5

40110
Para pata - M5

Válido para tablero fenólico de 13 mm

CERRADURA CRISTAL "U" CCR1 S/CILINDRO

	Código	8431488	Medida	Acabado			€uros
Caja	54529	545295	160x65,5 mm	INOX	-	1 10	
	54530	545301	160x65,5 mm	NE	-	1 10	

INOX: Acero Inoxidable
NE: Aluminio

No incluye cilindro

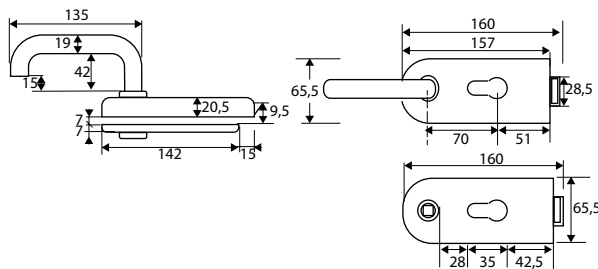

PICAPORTE CRISTAL "U" CCR3

	Código	8431488	Medida	Acabado			€uros
Caja	54533	545332	160x65,5 mm	INOX	-	1 10	
	54534	545349	160x65,5 mm	NE	-	1 10	

INOX: Acero Inoxidable
NE: Aluminio

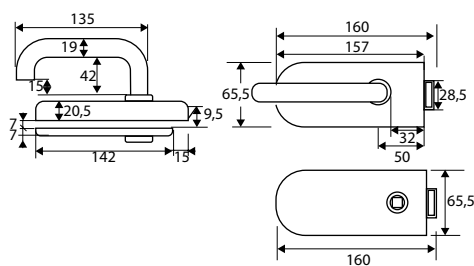

CERRADERO CRISTAL CCR2

	Código	8431488	Medida	Acabado			€uros
Caja	54531	545318	74x65,5 mm	INOX	-	1 50	
	54532	545325	74x65,5 mm	NE	-	1 50	

INOX: Acero Inoxidable
NE: Aluminio

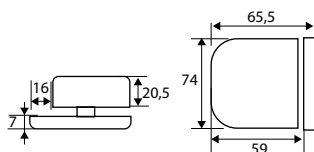

BISAGRA PARED-CRISTAL 180° BSC1

	Código	8431488	Medida	Acabado			€uros
Caja	54527	545271	102x50 mm	EI	-	1 24	
	54528	545288	102x50 mm	NE	-	1 24	

Aluminio

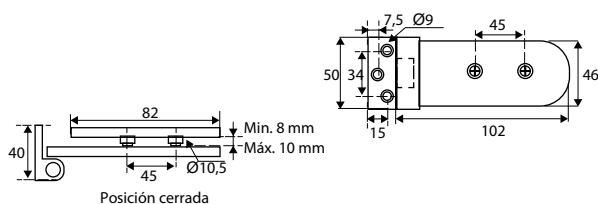

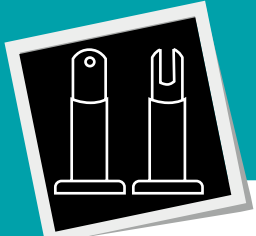

BISAGRA MAMPARA FIJA BSC2



	Código	843 I 488	Medida	Acabado				€uros
Caja	54536	545363	90x55 mm	INOX	-	1	30	
	54547	545479	90x55 mm	CB	-	1	20	

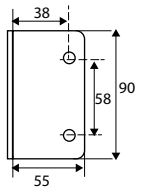

INOX: Acero Inoxidable
CB: Zamak



BISAGRA MAMPARA 90° S/ACCIÓN BSC3



	Código	843 I 488	Medida	Acabado				€uros
Caja	54537	545370	90x55 mm	INOX	-	1	30	
	54548	545486	90x55 mm	CB	-	1	30	

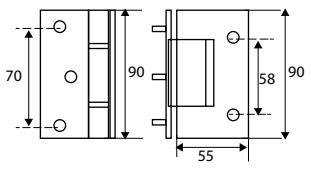

INOX: Acero Inoxidable
CB: Zamak



BISAGRA MAMPARA 90° D/ACCIÓN BSC4



	Código	843 I 488	Medida	Acabado				€uros
Caja	54538	545387	90x55 mm	INOX	-	1	30	
	54549	545493	90x55 mm	CB	-	1	30	

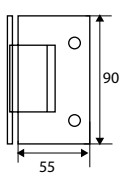

INOX: Acero Inoxidable
CB: Zamak



BISAGRA MAMPARA 90° D/ACCIÓN BSC5



	Código	843 I 488	Medida	Acabado				€uros
Caja	54539	545394	90x55 mm	INOX	-	1	30	
	54550	545509	90x55 mm	CB	-	1	30	

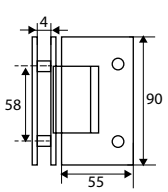

INOX: Acero Inoxidable
CB: Zamak



BISAGRA MAMPARA 135° D/ACCIÓN BSC6

	Código	8431488	Medida	Acabado				€uros
Caja	54540	545400	90x55 mm	INOX	-	1	30	
	54551	545516	90x55 mm	CB	-	1	30	

INOX: Acero Inoxidable
CB: Zamak

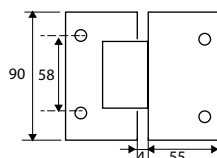

BISAGRA MAMPARA 180° D/ACCIÓN BSC7

	Código	8431488	Medida	Acabado				€uros
Caja	54541	545417	90x55 mm	INOX	-	1	30	
	54552	545523	90x55 mm	CB	-	1	20	

INOX: Acero Inoxidable
CB: Zamak

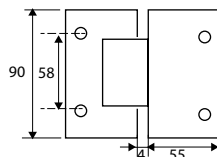

PINZA MAMPARA PARED-CRISTAL BSC15

	Código	8431488	Medida	Acabado				€uros
Caja	54556	545561	44 mm	INOX	-	10	100	
	54560	545608	44 mm	CB	-	10	100	

INOX: Acero Inoxidable
CB: Zamak

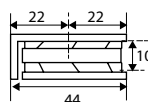

ÁNGULO MAMPARA 90° PARED-CRISTAL BSC16

	Código	8431488	Medida	Acabado				€uros
Caja	54557	545578	44x44 mm	INOX	-	10	100	
	54561	545615	44x44 mm	CB	-	10	100	

INOX: Acero Inoxidable
CB: Zamak

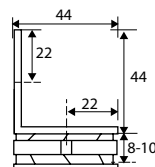

ÁNGULO MAMPARA 90° CRISTAL-CRISTAL BSC17

	Código	8431488	Medida	Acabado				€uros
Caja	54558	545585	44x44 mm	INOX	-	10	100	
	54562	545622	44x44 mm	CB	-	10	100	

INOX: Acero Inoxidable
CB: Zamak

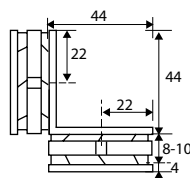

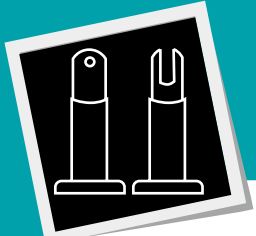

ÁNGULO MAMPARA 135° CRISTAL-CRISTAL BSC19

	Código	8431488	Medida	Acabado				€uros
Caja	54559	545592	44x44 mm	INOX	-	10	100	
	54564	545646	44x44 mm	CB	-	10	100	

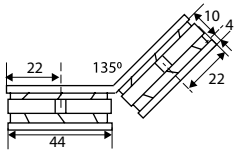

INOX: Acero Inoxidable
CB: Zamak

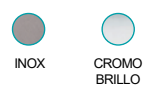

ÁNGULO MAMPARA 180° CRISTAL-CRISTAL BSC18

	Código	8431488	Medida	Acabado				€uros
Caja	54571	545714	90 mm	INOX	-	10	100	
	54563	545639	90 mm	CB	-	10	100	

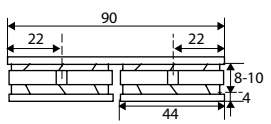

INOX: Acero Inoxidable
CB: Zamak



TUBO MAMPARA EXTENSIBLE BSC10

	Código	8431488	Medida A	Acabado				€uros
Caja	54544	545448	600-800 mm	INOX	-	1	25	
	54545	545455	800-1000 mm	INOX	-	1	25	

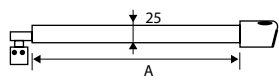

Acero Inoxidable



ÁNGULO CONECTOR TUBO MAMPARA BSC20

	Código	8431488	Medida	Acabado				€uros
Caja	54543	545431	25 mm	INOX	-	1	50	

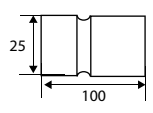

Acero Inoxidable



SOPORTE TUBO MAMPARA BSC11

	Código	8431488	Medida	Acabado				€uros
Caja	54546	545462	25 mm	INOX	-	1	100	

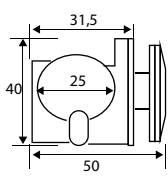

Acero Inoxidable



JGO POMO MAMPARA BSC12

	Código	8431488	Medida	Acabado				€uros
Caja	54553	545530	37x20 mm	CB	-	1	100	
Blister	92276	922768	37x20 mm	CB	1	-	10	

Zamak



CROMO BRILLO

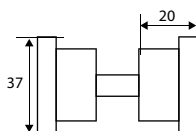

JGO POMO MAMPARA BSC13

	Código	8431488	Medida	Acabado				€uros
Caja	54554	545547	30x28 mm	CB	-	1	50	
Blister	92277	922775	30x28 mm	CB	1	-	10	

Zamak



CROMO BRILLO

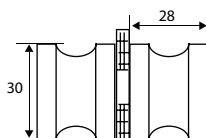

JGO POMO MAMPARA BSC14

	Código	8431488	Medida	Acabado				€uros
Caja	54555	545554	30x30 mm	CB	-	1	50	
Blister	92278	922782	30x30 mm	CB	1	-	10	

Zamak



CROMO BRILLO

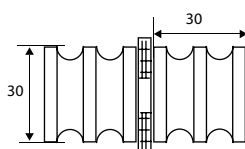

JGO TIRADOR EMBUTIR MAMPARA BSC8

	Código	8431488	Medida	Acabado				€uros
Caja	54542	545424	50 mm	INOX	-	1	100	
Blister	92275	922751	50 mm	INOX	1	-	10	

Acero Inoxidable



INOX

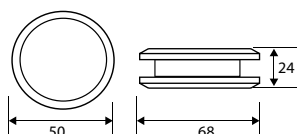

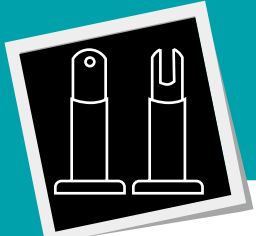

PERFIL MAMPARA BURBUJA PF3



Código	8431488	Cristal	Acabado				€uros
18525	185255	6/8 mm	TR	-	8	-	
18526	185262	8/10 mm	TR	-	8	-	

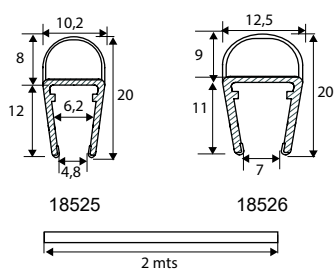

PVC



PERFIL MAMPARA BAÑERA PF4

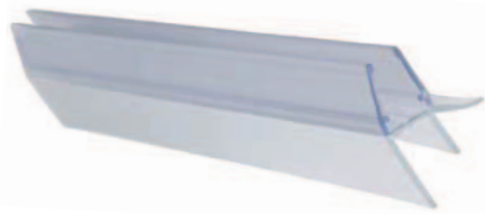

Código	8431488	Cristal	Acabado				€uros
18527	185279	6/8 mm	TR	-	8	-	

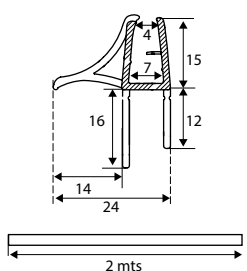

PVC



PERFIL MAMPARA VIERTEAGUA PF6

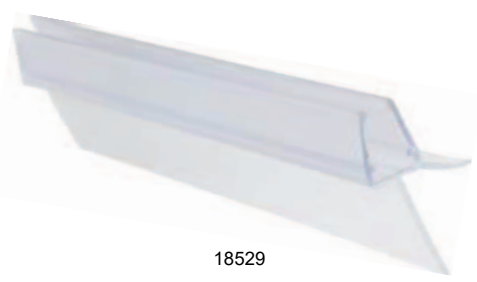

18529

Código	8431488	Cristal - Medida	Acabado				€uros
18529	185293	6/8 mm - 19,5 mm	TR	-	8	-	
18530	185309	6/8 mm - 11,5 mm	TR	-	8	-	
18534	185347	8/10 mm - 11,5 mm	TR	-	8	-	

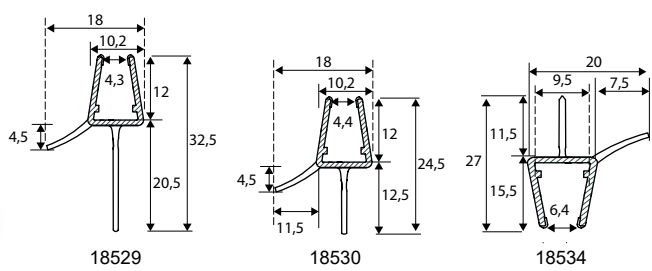





PVC



18530-18534



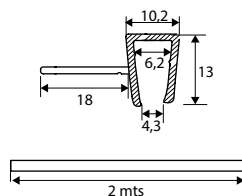

PERFIL MAMPARA JUNTA CRUCE PF5

Código	8431488	Cristal	Acabado				€uros
 18528	185286	6/8 mm	TR	-	8	-	

PVC





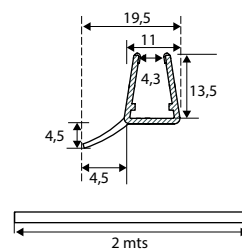

PERFIL MAMPARA VIERTEGUA CENTRAL PF7

Código	8431488	Cristal	Acabado				€uros
 18531	185316	6/8 mm	TR	-	8	-	

PVC



PERFIL MAMPARA JUNTA PF8

Código	8431488	Cristal - Medida	Acabado				€uros
 18532	185323	6/8 mm - 23 mm	TR	-	8	-	
18533	185330	6/8 mm - 13 mm	TR	-	8	-	
18535	185354	8/10 mm - 23 mm	TR	-	8	-	

PVC

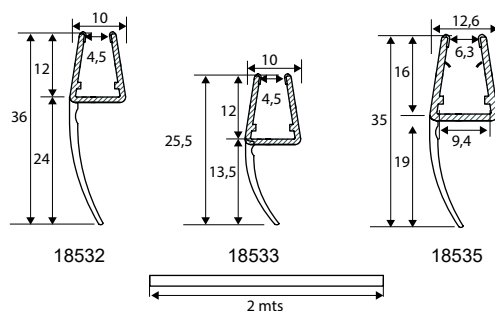

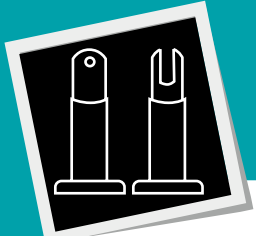

PERFIL MAMPARA MAGNÉTICO 45° N-S PF2

Código	8431488	Cristal	Acabado				€uros
18523	185231	6/8 mm	TR	-	8	-	
18536	185361	8/10 mm	TR	-	8	-	

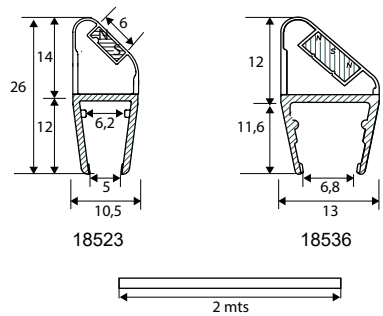
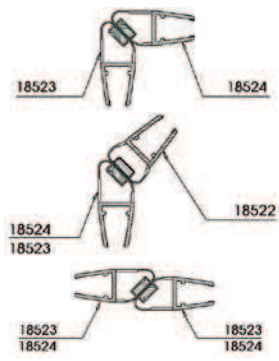

PVC



PERFIL MAMPARA MAGNÉTICO 45° S-N PF2

Código	8431488	Cristal	Acabado				€uros
18524	185248	6/8 mm	TR	-	8	-	
18537	185378	8/10 mm	TR	-	8	-	

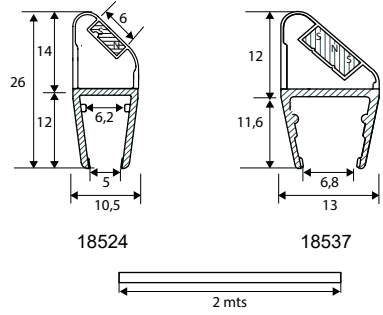
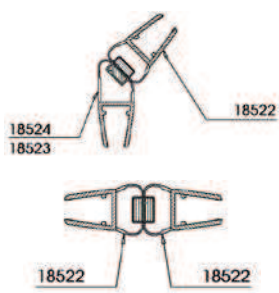

PVC



PERFIL MAMPARA MAGNÉTICO 180° PF1

Código	8431488	Cristal	Acabado				€uros
18522	185224	6/8 mm	TR	-	8	-	

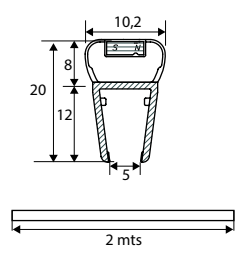

PVC



Te sugiero:

RODAMIENTOS MAMPARA
Pág. 87-88-89





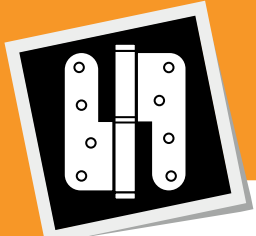

PICAPORTE CONDENA PCT1

	Código	8431488	Medida	Acabado			€uros
Caja	10100	101002	47 mm	LTD	-	10	100
	10101	101019	47 mm	NS	-	10	100
	10102	101026	47 mm	NE	-	10	100
	10103	101033	47 mm	CU	-	10	100
Blister	90842	908427	47 mm	LTD	1	-	10
	90843	908434	47 mm	NS	1	-	10
	91564	915647	47 mm	NE	1	-	10
	91565	915654	47 mm	CU	1	-	10

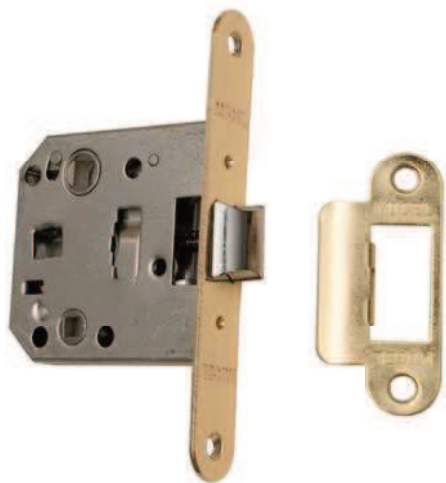

Canto redondo

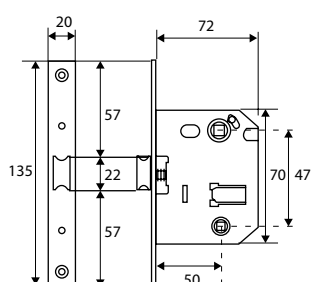

Acero

- LATONADO
- NIQUEL SATINADO
- NEGRO
- CUERO

PICAPORTE CONDENA PCT2

	Código	8431488	Medida	Acabado			€uros
Caja	10170	101705	70 mm	LTD	-	10	100
	10171	101712	70 mm	NS	-	10	100
	10172	101729	70 mm	NE	-	10	100
Blister	91186	911861	70 mm	LTD	1	-	10
	91187	911878	70 mm	NS	1	-	10
	91566	915661	70 mm	NE	1	-	10

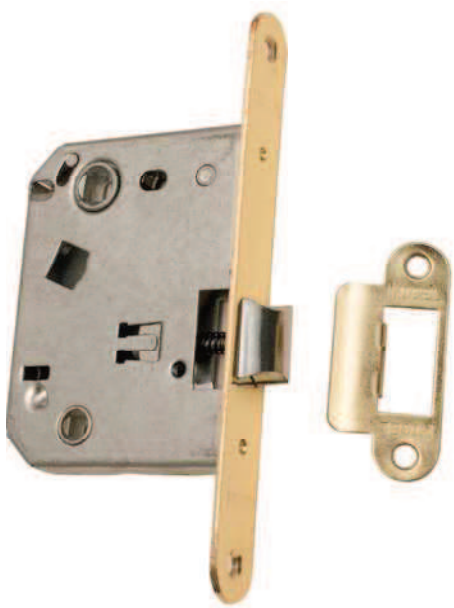

Canto redondo

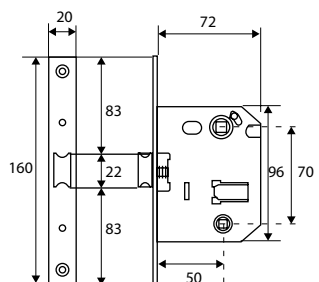

Acero

- LATONADO
- NIQUEL SATINADO
- NEGRO

PICAPORTE TUBULAR PCT3

	Código	8431488	Canto/Medida A	Acabado				€uros
Caja	10111	101118	cuadrado/35 mm	LTD	-	20	200	
	10112	101125	cuadrado/35 mm	NS	-	20	200	
	10114	101149	redondo/45 mm	LTD	-	20	200	
	10115	101156	redondo/45 mm	NS	-	20	200	
	10116	101163	cuadrado/45 mm	LTD	-	20	200	
	10117	101170	cuadrado/45 mm	NS	-	20	200	
	10119	101194	cuadrado/60 mm	LTD	-	20	200	
	10120	101200	cuadrado/60 mm	NS	-	20	200	
	10121	111216	cuadrado/70 mm	LTD	-	20	200	
	10122	111223	cuadrado/70 mm	NS	-	20	200	
Blister	90119	901190	cuadrado/35 mm	LTD	1	-	10	
	90120	901206	cuadrado/35 mm	NS	1	-	10	
	90123	901237	redondo/45 mm	LTD	1	-	10	
	90124	901244	redondo/45 mm	NS	1	-	10	
	90121	901213	cuadrado/45 mm	LTD	1	-	10	
	90122	901220	cuadrado/45 mm	NS	1	-	10	
	91578	915784	cuadrado/60 mm	LTD	1	-	10	
	91579	915791	cuadrado/60 mm	NS	1	-	10	
	91668	916682	cuadrado/70 mm	LTD	1	-	10	
91669	916699	cuadrado/70 mm	NS	1	-	10		



Acero
 LATONADO
 NÍQUEL SATINADO

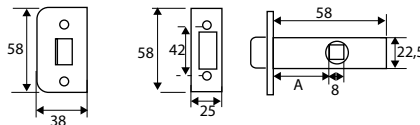

CONDENA PICAPORTE TUBULAR PCT4

	Código	8431488	Medida	Acabado				€uros
Caja	10145	101453	45 mm	LTD	-	20	200	
	10146	101460	45 mm	NS	-	20	200	
Blister	91670	916705	45 mm	LTD	1	-	10	
	91671	916712	45 mm	NS	1	-	10	

Acero
 LATONADO
 NÍQUEL SATINADO

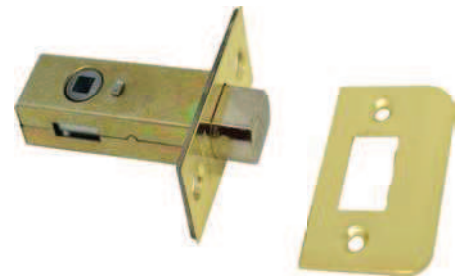
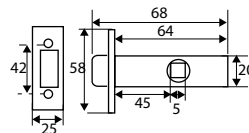

CERRADERO PICAPORTE PCT1/PCT3

	Código	8431488	Modelo	Acabado				€uros
Caja	10106	101064	condena PCT1	LTD	-	50	500	
	10107	101071	condena PCT1	NS	-	50	500	
	10108	101088	tubular PCT3	LTD	-	50	500	
	10109	101095	tubular PCT3	NS	-	50	500	
Blister	91672	916729	condena PCT1	LTD	1	-	10	
	91673	916736	condena PCT1	NS	1	-	10	
	91674	916743	tubular PCT3	LTD	1	-	10	
	91675	916750	tubular PCT3	NS	1	-	10	

Acero
 LATONADO
 NÍQUEL SATINADO

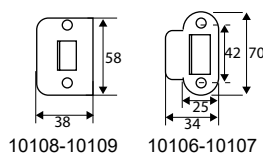

10108



10107

10108-10109 10106-10107

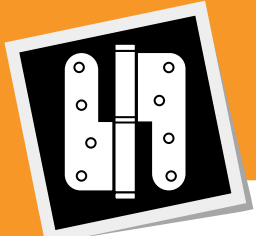

PICAPORTE RODILLO PCT5



	Código	8431488	Medida AxB	Acabado				€uros
Caja	10125	101255	80x18 mm	BC	-	12	60	
	10126	101262	100x21 mm	BC	-	12	60	
	10127	101279	120x23 mm	BC	-	12	60	
Blister	91676	916767	80x18 mm	BC	1	-	10	
	91677	916774	100x21 mm	BC	1	-	10	
	91678	916781	120x23 mm	BC	1	-	10	

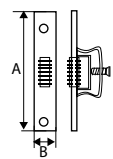

Acero



PICAPORTE VAIVÉN PCT6



	Código	8431488	Medida AxB	Acabado				€uros
Caja	10128	101286	60x15 mm	BC	-	12	120	
	10129	101293	80x18 mm	BC	-	12	120	
	10142	101422	100x21 mm	BC	-	12	120	
Blister	91679	916798	60x15 mm	BC	1	-	10	
	91680	916804	80x18 mm	BC	1	-	10	
	91681	916811	100x21 mm	BC	1	-	10	

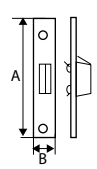

Acero



KIT PUERTA CORREDERA PCR3

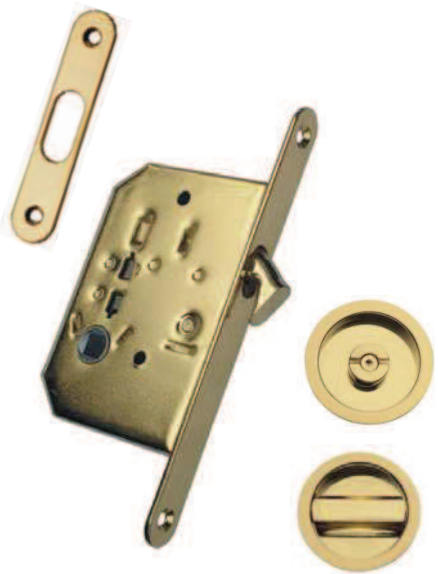

	Código	8431488	Puerta	Acabado				€uros
Caja	48001	480015	35 mm	LTD	-	1	20	
	48002	480022	35 mm	NS	-	1	20	
	48003	480039	35 mm	CU	-	1	20	
	48008	480084	35 mm	NE	-	1	20	

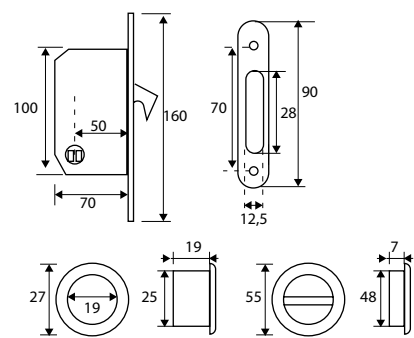

Acero



KIT PUERTA CORREDERA CUADRADO PCR4

	Código	8431488	Puerta	Acabado				€uros
Caja	48501	485010	35 mm	LTD	-	1	20	
	48502	485027	35 mm	NS	-	1	20	

Acero

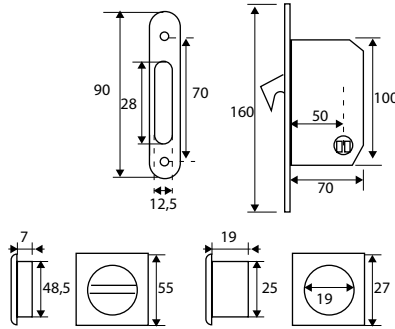

KIT PUERTA CORREDERA BOCALLAVE PCR5

	Código	8431488	Puerta	Acabado				€uros
Caja	48401	484013	35 mm	LTD	-	1	20	
	48402	484020	35 mm	NS	-	1	20	
	48403	484037	35 mm	CU	-	1	20	

Acero

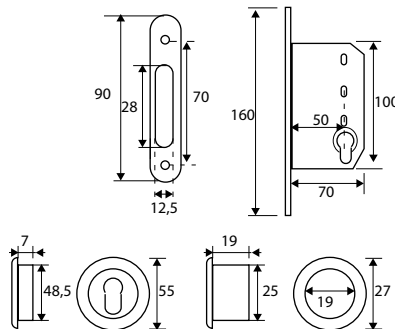

Te sugiero:



TIRADORES - Pág. 208-209

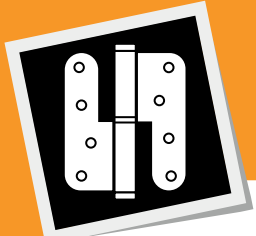

CERRADURA PICOLORO CRR3



Incluye cilindro

	Código	8431488	Medida A	Acabado				€uros
Caja	68120	681207	30 mm	ZN	-	1	10	
	68119	681191	40 mm	ZN	-	1	10	
	68118	681184	60 mm	ZN	-	1	10	

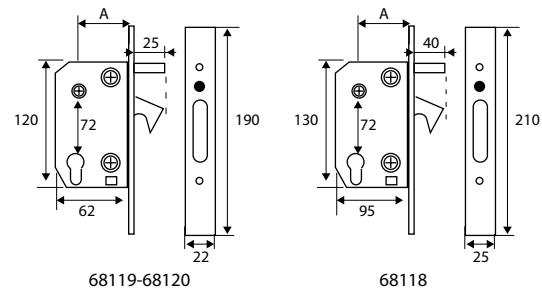

Acero

ZINCADO

CERRADERO P/CERRADURA PICOLORO CRR3

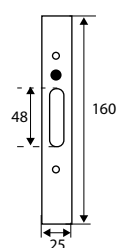

	Código	8431488	Medida	Acabado				€uros
	68121	681214	160x25 mm	ZN	-	1	5	

Acero

ZINCADO

CAJA CERRADURA PICOLORO CRR3

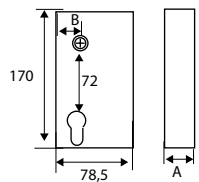

	Código	8431488	Medida A - B	Acabado				€uros
Caja	68103	681030	40 - 20	ZN	-	1	10	
	68104	681047	50 - 10	ZN	-	1	10	

Acero

ZINCADO

CIERRAPUERTAS S/RETENEDOR MC1-S

	Código	8431488	Fuerza	Acabado				€uros
Caja	57208	572086	2-3	PL	-	1	10	
	57209	572093	2-3	BL	-	1	10	
	57210	572109	2-3	NE	-	1	10	
	57211	572116	2-3	OR	-	1	10	
Blister	57216	572161	2-3	PL	1	-	10	
	57217	572178	2-3	BL	1	-	8	
	57218	572185	2-3	NE	1	-	8	

Aluminio



Máximo peso de la puerta 70 kgs
Para puerta de 700-900 mm
Vale para puerta doble y sencilla

Fuerza 2: 40 kgs
Fuerza 3: 70 kgs

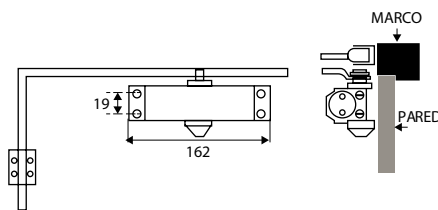

CIERRAPUERTAS C/RETENEDOR MC1-C

	Código	8431488	Fuerza	Acabado				€uros
Caja	57212	572123	2-3	PL	-	1	10	
	57213	572130	2-3	BL	-	1	10	
	57214	572147	2-3	NE	-	1	10	
	57215	572154	2-3	OR	-	1	10	
Blister	57219	572192	2-3	PL	1	-	8	

Aluminio



Máximo peso de la puerta 70 kgs
Para puerta de 700-900 mm
Vale para puerta doble y sencilla

Fuerza 2: 40 kgs
Fuerza 3: 70 kgs

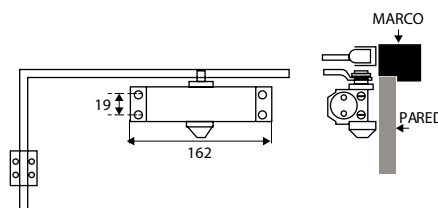

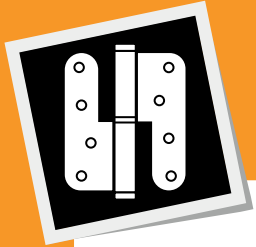

MUELLE CIERRAPUERTAS BRAZO MC2

	Código	8431488	Medida AxB	Acabado				€uros
Blister	57201	572017	200x30 mm	BL	1	-	10	
	57202	572024	200x30 mm	NE	1	-	10	
	57203	572031	200x30 mm	OR	1	-	10	
	57204	572048	200x30 mm	PL	1	-	10	

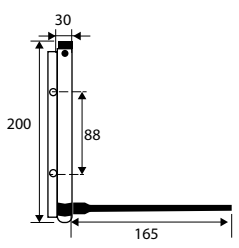

Aluminio

BLANCO
 NEGRO
 ORO
 PLATA

MUELLE CIERRAPUERTAS MC3

	Código	8431488	Medida AxB	Acabado				€uros
Caja	57205	572055	Nº1: 95x240 mm	ZN	-	4	20	
	57206	572062	Nº2: 120x240 mm	ZN	-	4	20	

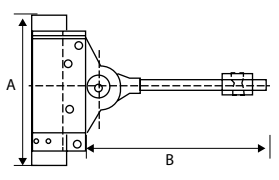
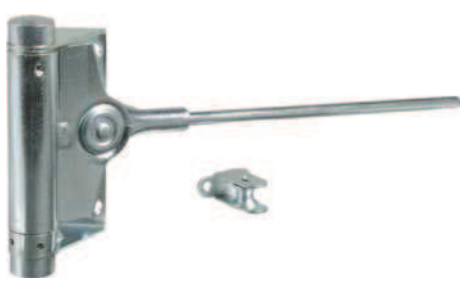

Acero

ZINCADO

CAPACIDAD DE CARGA
 57205.....Máx.. 25 Kilos
 57206.....Máx.. 40 Kilos

MUELLE CIERRAPUERTAS ESPIRAL MC4

	Código	8431488	Medida	Acabado				€uros
Caja	57207	572079	200 mm	NI	-	5	25	

Puerta máximo 40 kgs

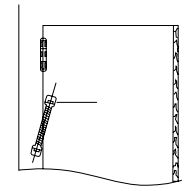
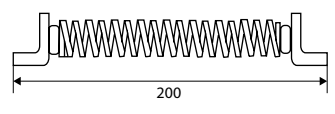

Acero

NIQUEL

BISAGRA DOBLE ACCIÓN BS10

	Código	8431488	Medida AxBxC	Acabado				€uros
Blister	57001	570013	180x133x4 mm	BL	1	-	10	
	57002	570020	180x133x4 mm	NE	1	-	10	
	57003	570037	180x133x4 mm	OR	1	-	10	
	57004	570044	180x133x4 mm	PL	1	-	10	
	57005	570051	180x133x4 mm	BR	1	-	10	

Aluminio

C= espesor



Peso de 2 bisagras hasta 50 kilos
Peso de 3 bisagras hasta 95 kilos

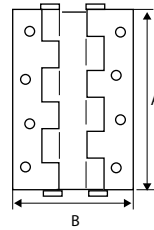

BISAGRA DOBLE ACCIÓN BS12

	Código	8431488	Medida AxB	Acabado				€uros
Caja	57006	570068	75x29 mm	LTD	-	2	20	
	57007	570075	100x30 mm	LTD	-	2	10	
	57008	570082	125x33 mm	LTD	-	2	10	

Acero



57006..... 15 Kgs - para puerta de 600 mm (ancho 18-25 mm)
57007..... 22 Kgs - para puerta de 700 mm (ancho 25-30 mm)
57008..... 27 Kgs - para puerta de 700 mm (ancho 30-35 mm)

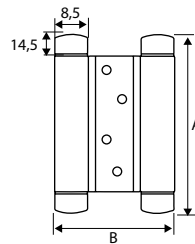

BISAGRA SIMPLE ACCIÓN BS11

	Código	8431488	Medida AxBxC	Acabado				€uros
Blister	57101	571010	180x133x4 mm	BL	1	-	10	
	57102	571027	180x133x4 mm	NE	1	-	10	
	57103	571034	180x133x4 mm	OR	1	-	10	
	57104	571041	180x133x4 mm	PL	1	-	10	

Aluminio

C= espesor



Peso de 2 bisagras hasta 50 kilos
Peso de 3 bisagras hasta 95 kilos

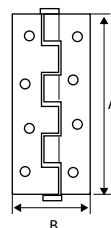

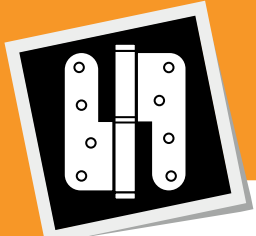

BISAGRA SEGURIDAD C/REMATE BS15

Código	8431488	Canto	Acabado				€uros
58180	581804	redondo	LTD	-	1	20	
59180	591803	cuadrado	LTD	-	1	20	
58184	581842	redondo	NS	-	1	20	
59184	591841	cuadrado	NS	-	1	20	
58181	581811	redondo	CU	-	1	20	
59181	591810	cuadrado	CU	-	1	20	
58183	581835	redondo	NE	-	1	20	
59183	591834	cuadrado	NE	-	1	20	
58185	581859	redondo	PE	-	1	20	
59185	591858	cuadrado	PE	-	1	20	

Espesor 3 mm

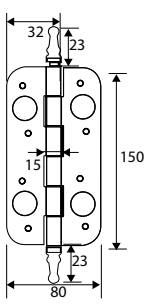

Acero

- LATONADO
- NIQUEL SATINADO
- CUERO
- NEGRO
- PLATA ENVEJECIDA

BISAGRA SEGURIDAD S/REMATE BS16

Código	8431488	Canto	Acabado				€uros
58187	581873	redondo	NS	-	1	20	
59187	591872	cuadrado	NS	-	1	20	
58186	581866	redondo	INOX	-	1	20	
59186	591865	cuadrado	INOX	-	1	20	

Espesor 3 mm

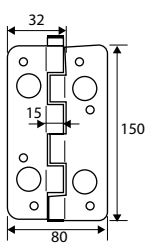

NS: Acero
INOX: Acero Inoxidable

- NIQUEL SATINADO
- INOX



BISAGRA BS18 (PALA JUNTO NUDO)

Código	8431488	Medida AxB	Canto/Mano				€uros
11020	110202	90x65 mm	CR/dcha	-	10	100	
11021	110219	90x65 mm	CR/izda	-	10	100	
11022	110226	90x65 mm	CC/dcha	-	10	100	
11023	110233	90x65 mm	CC/izda	-	10	100	

Espesor 2,5 mm

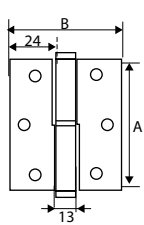

Acero Inoxidable

- INOX

CR: redondo
CC: cuadrado

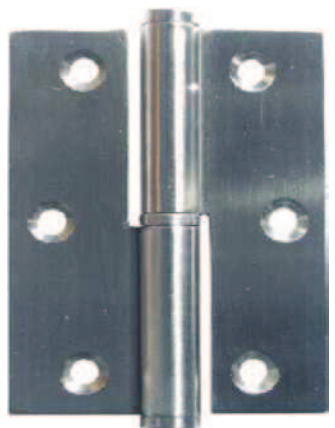

BISAGRA BS17 (PALA SEPARADA NUDO)

	Código	8431488	Medida AxBxC	Canto/Mano			€uros
Caja	11024	110240	90x65x2,5 mm	CR/dcha	-	10	100
	11025	110257	90x65x2,5 mm	CR/izda	-	10	100
	11028	110288	100x86x3 mm	CR/dcha	-	2	60
	11029	110295	100x86x3 mm	CR/izda	-	2	60
	11030	110301	100x86x3 mm	CC/dcha	-	2	50
	11031	110318	100x86x3 mm	CC/izda	-	2	50

Acero Inoxidable



INOX

CR: redondo
CC: cuadrado

C: Espesor

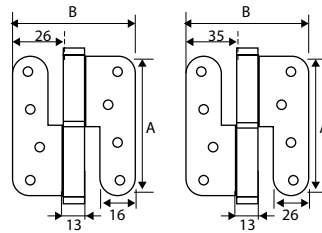

11024-11025

11028-11029
11030-11031



PERNIO S/REMATE PN7

	Código	8431488	Medida/Mano	Acabado			€uros
Caja	20703	207032	80x50 mm/dcha	INOX	-	20	240
	20704	207049	80x50 mm/izda	INOX	-	20	240
	20701	207018	100x58 mm/dcha	INOX	-	20	240
	20702	207025	100x58 mm/izda	INOX	-	20	240
Blister	92207	922072	80x50 mm/dcha	INOX	2	-	10
	92208	922089	80x50 mm/izda	INOX	2	-	10
	90948	909486	100x58 mm/dcha	INOX	2	-	10
	90949	909493	100x58 mm/izda	INOX	2	-	10

Acero Inoxidable



INOX

Incluye tornillos en el blister

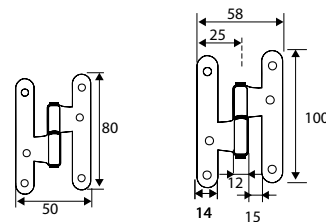

20703-20704

20701-20702

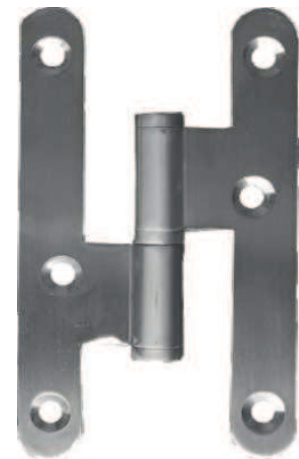

PERNIO S/REMATE PN9

	Código	8431488	Medida/Mano	Acabado			€uros
Caja	11015	110158	95x54 mm/dcha	LTD	-	20	240
	11016	110165	95x54 mm/izda	LTD	-	20	240
	11017	110172	95x54 mm/dcha	NS	-	20	240
	11018	110189	95x54 mm/izda	NS	-	20	240
Blister	92199	921990	95x54 mm/dcha	LTD	2	-	10
	92200	922003	95x54 mm/izda	LTD	2	-	10
	92201	922010	95x54 mm/dcha	NS	2	-	10
	92202	922027	95x54 mm/izda	NS	2	-	10

Acero



LATONADO

NIQUEL SATINADO

Incluye tornillos en el blister

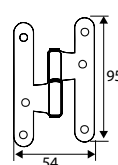

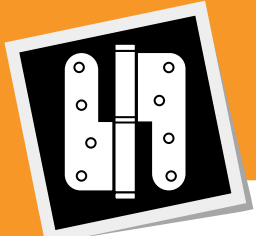

PERNIO C/REMATE PN3

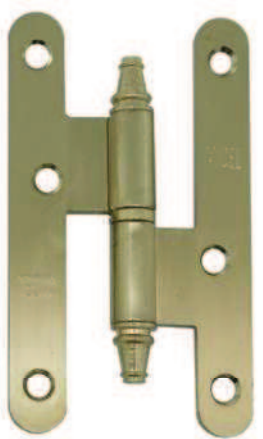

	Código	843 I 488	Medida/Mano	Acabado				€uros
Caja	11040	110400	100x58 mm/dcha	LS	-	20	240	
	11041	110417	100x58 mm/izda	LS	-	20	240	
	11060	110608	100x58 mm/dcha	CU	-	20	240	
	11061	110615	100x58 mm/izda	CU	-	20	240	
	11070	110707	100x58 mm/dcha	NE	-	20	240	
	11071	110714	100x58 mm/izda	NE	-	20	240	
Blister	90924	909240	100x58 mm/dcha	LS	2	-	10	
	90925	909257	100x58 mm/izda	LS	2	-	10	
	90928	909288	100x58 mm/dcha	CU	2	-	10	
	90929	909295	100x58 mm/izda	CU	2	-	10	
	90930	909301	100x58 mm/dcha	NE	2	-	10	
	90931	909318	100x58 mm/izda	NE	2	-	10	

Incluye tornillos en el blister

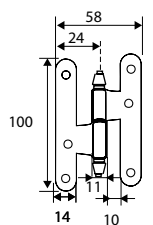

Acero

LATÓN SATINADO CROMO NEGRO

PERNIO S/REMATE PN4

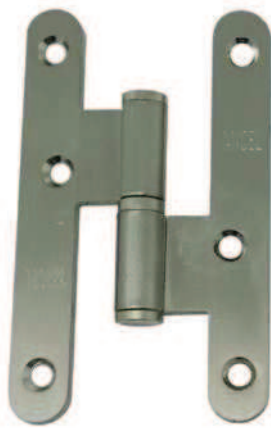

	Código	843 I 488	Medida/Mano	Acabado				€uros
Caja	11080	110806	100x58 mm/dcha	LS	-	20	240	
	11081	110813	100x58 mm/izda	LS	-	20	240	
	11090	110905	100x58 mm/dcha	NS	-	20	240	
	11091	110912	100x58 mm/izda	NS	-	20	240	
Blister	90932	909325	100x58 mm/dcha	LS	2	-	10	
	90933	909332	100x58 mm/izda	LS	2	-	10	
	90934	909349	100x58 mm/dcha	NS	2	-	10	
	90935	909356	100x58 mm/izda	NS	2	-	10	

Incluye tornillos en el blister

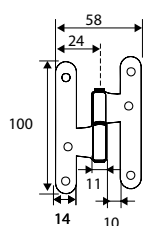

Acero

LATÓN SATINADO NIQUEL SATINADO

PERNIO S/REMATE PN6

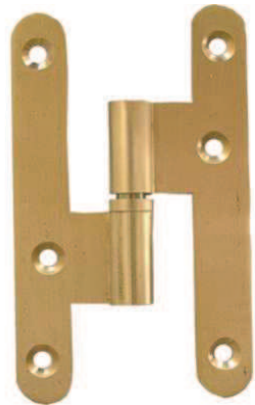

	Código	843 I 488	Medida/Mano	Acabado				€uros
Caja	85010	850108	100x57 mm/dcha	LTD	-	20	240	
	85011	850115	100x57 mm/izda	LTD	-	20	240	

Aluminio

LATONADO

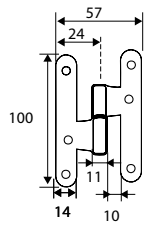

OVALILLO PERNIO OV1

	Código	8431488	Medida	Acabado				€uros
Caja	11012	110127	7x10,5x3 mm	LTD	-	100	2.500	
	11013	110134	7x10,5x3 mm	NE	-	100	2.500	
	11014	110141	7x10,5x3 mm	INOX	-	100	2.500	
Blister	90721	907215	7x10,5x3 mm	LTD	10	-	10	
	90722	907222	7x10,5x3 mm	NE	10	-	10	
	91885	918853	7x10,5x3 mm	INOX	10	-	10	

LTD: Acero; NE: Nylon; INOX: Acero Inoxidable

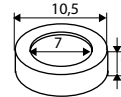

OVALILLO LATÓN OV2

	Código	8431488	Medida A-B-C	Acabado				€uros
Caja	68110	681108	10x7x1,5 mm	LT	-	50	1.250	
	68334	683348	10x7x2 mm	LT	-	50	1.250	
	68111	681115	12x8x1,5 mm	LT	-	50	1.250	
	68335	683355	12x8x2 mm	LT	-	50	1.250	
	68112	681122	14x9x2 mm	LT	-	50	1.250	
	68336	683362	14x9x3 mm	LT	-	50	1.250	
	68113	681139	16x11x2 mm	LT	-	50	1.250	
	68337	683379	16x11x3 mm	LT	-	50	1.250	
	68114	681146	18x11x2 mm	LT	-	50	1.250	
	68338	683386	18x11x3 mm	LT	-	50	1.250	
	68115	681153	20x12x2 mm	LT	-	50	1.250	
	68339	683393	20x12x3 mm	LT	-	50	1.250	
	68116	681160	22x14x2,5 mm	LT	-	50	1.250	
68117	681177	25x15x2,5 mm	LT	-	50	1.250		
Blister	91654	916545	10x7x1,5 mm	LT	6	-	10	
	92315	923154	10x7x2 mm	LT	6	-	10	
	91655	916552	12x8x1,5 mm	LT	6	-	10	
	92316	923161	12x8x2 mm	LT	6	-	10	
	91656	916569	14x9x2 mm	LT	6	-	10	
	92317	923178	14x9x3 mm	LT	6	-	10	
	91657	916576	16x11x2 mm	LT	6	-	10	
	92318	923185	16x11x3 mm	LT	6	-	10	
	91658	916583	18x11x2 mm	LT	6	-	10	
	92319	923192	18x11x3 mm	LT	6	-	10	
	91659	916590	20x12x2 mm	LT	4	-	10	
	92320	923208	20x12x3 mm	LT	4	-	10	
	91660	916606	22x14x2,5 mm	LT	4	-	10	
91661	916613	25x15x2,5 mm	LT	4	-	10		

Latón

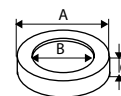

OVALILLO LATÓN SURTIDO OV2

	Código	8431488	Medida	Acabado				€uros
Blister	92321	923215	SURTIDO	LT	8	-	10	4,7500

Latón



Incluye:
 2 uds - 68110 (10x7x1,5 mm)
 2 uds - 68111 (12x8x1,5 mm)
 2 uds - 68112 (14x9x2 mm)
 2 uds - 68113 (16x11x2 mm)



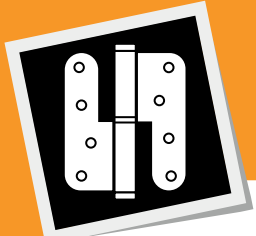

PERNIO TORNEADO 692

	Código	843 I488	Medida AxB	Acabado				€uros
Caja	68078	680781	10x58 mm	PU	-	60	-	
	68079	680798	12x70 mm	PU	-	45	-	
	68080	680804	14x80 mm	PU	-	28	-	
	68081	680811	16x100 mm	PU	-	35	-	
	68082	680828	20x120 mm	PU	-	20	-	
Blister	91302	913025	10x58 mm	PU	3	-	10	
	91303	913032	12x70 mm	PU	3	-	10	
	91304	913049	14x80 mm	PU	2	-	10	
	91305	913056	16x100 mm	PU	2	-	10	

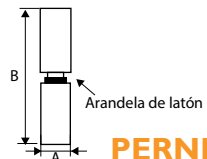

Acero

 HIERRO PULIDO

PERNIO TORNEADO 693

	Código	843 I488	Medida AxB	Acabado				€uros
Caja	68083	680835	10x60 mm	INOX	-	20	-	
	68084	680842	12x70 mm	INOX	-	20	-	
	68085	680859	14x80 mm	INOX	-	14	-	
	68086	680866	16x100 mm	INOX	-	15	-	

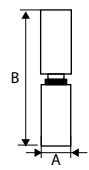

Acero Inoxidable

 INOX

PERNIO RODAMIENTO AXIAL 694

	Código	843 I488	Medida AxB	Acabado				€uros
Caja	68087	680873	16x100 mm	PU	-	35	-	
	68088	680880	20x120 mm	PU	-	20	-	
	68089	680897	22x120 mm	PU	-	16	-	
Blister	91310	913100	16x100 mm	PU	2	-	10	

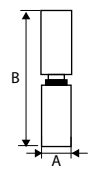

Acero

 HIERRO PULIDO

PERNIO PERFIL GOTA 695

	Código	843 I488	Medida AxB	Acabado				€uros
Caja	68090	680903	10x60 mm	PU	-	60	-	
	68091	680910	14x80 mm	PU	-	28	-	
	68092	680927	16x100 mm	PU	-	35	-	
	68093	680934	16x120 mm	PU	-	30	-	
Blister	91311	913117	10x60 mm	PU	3	-	10	
	91312	913124	14x80 mm	PU	2	-	10	
	91313	913131	16x100 mm	PU	2	-	10	

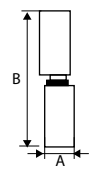

Acero

 HIERRO PULIDO

PERNIO PALA 696

	Código	8431488	Medida AxBxCxD	Acabado				€uros
Caja	68094	680941	10x60x2x17 mm	PU	-	40	-	
	68095	680958	14x80x3x29 mm	PU	-	20	-	
	68096	680965	16x100x3x30 mm	PU	-	24	-	
	68097	680972	18x110x4x30 mm	PU	-	16	-	
Blister	91314	913148	10x60x2x17 mm	PU	3	-	10	
	91315	913155	14x80x3x29 mm	PU	3	-	10	
	91316	913162	16x100x3x30 mm	PU	3	-	10	

Acero



HIERRO
PULIDO

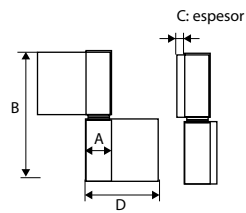

PERNIO PALA LARGA 699

	Código	8431488	Medida AxBxCxD	Acabado				€uros
Caja	68072	680729	14x80x3x38 mm	PU	-	20	-	
	68074	680743	16x100x3x39 mm	PU	-	20	-	
Blister	91317	913179	14x80x3x38 mm	PU	3	-	10	
	91318	913186	16x100x3x39 mm	PU	3	-	10	

Acero



HIERRO
PULIDO

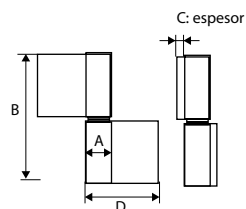

BISAGRA LIBRO 697

	Código	8431488	Medida AxBxCxD	Acabado				€uros
Caja	68098	680989	80x50x3x18,5 mm	PU	-	20	-	
	68099	680996	100x64x4x19 mm	PU	-	12	-	
	68075	680750	150x60x4x18 mm	PU	-	10	-	

Acero



HIERRO
PULIDO

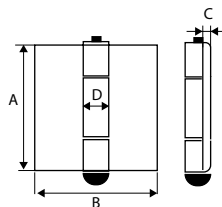

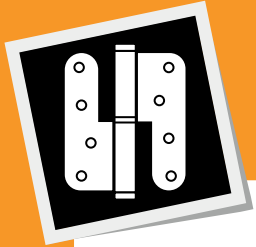

JGO BISAGRA PIVOTANTE BS9

	Código	8431488	Canto	Acabado				€uros
Caja	65003	650036	redondo	INOX	-	1	20	
	65004	650043	cuadrado	INOX	-	1	20	

Peso máximo 100 Kgs

Acero Inoxidable

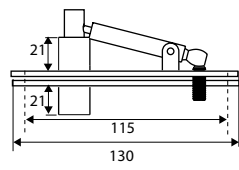
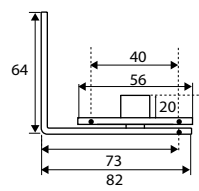

JGO BISAGRA PIVOTANTE BS13

	Código	8431488	Medida	Acabado				€uros
Caja	65001	650012	80x10 mm	LTD	-	24	120	

Acero

1 juego contiene:
4 machos y 4 hembras

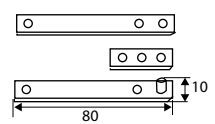

JGO BISAGRA PIVOTANTE BS14

	Código	8431488	Medida	Acabado				€uros
Caja	65002	650029	60x10 mm	LTD	-	24	120	

Acero

1 juego contiene:
2 machos izquierda, 2 machos derecha,
2 hembras izquierda y 2 hembras derecha

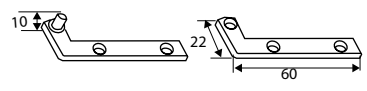

BISAGRA OCULTA BS3

	Código	8431488	Medida	Acabado				€uros
Caja	67353	673530	89x25 mm	INOX	-	20	60	

Acero Inoxidable

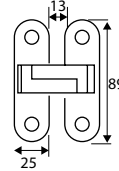

BISAGRA OCULTA BS4

	Código	8431488	Medida Ax B	Acabado				€uros
Caja	67354	673547	60x12,7 mm	INOX	-	2	50	
	67355	673554	70x15,8 mm	INOX	-	2	50	
	67356	673561	95x19,5 mm	INOX	-	2	20	

Acero Inoxidable

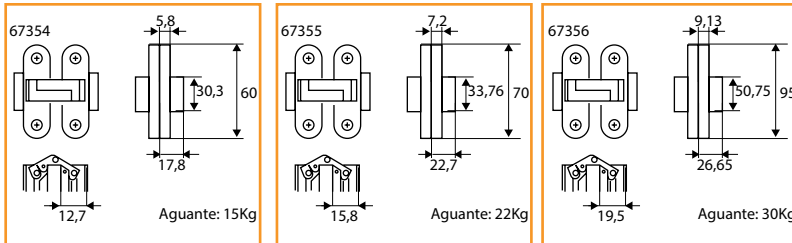

BISAGRA OCULTA BS2

	Código	8431488	Medida Ax B	Acabado				€uros
Caja	67350	673509	65x13 mm	LTD	-	20	200	
	67351	673516	65x13 mm	NI	-	20	200	
	67352	673523	65x13 mm	BR	-	20	200	
Blister	91682	916828	65x13 mm	LTD	2	-	10	
	91683	916835	65x13 mm	NI	2	-	10	
	91684	916842	65x13 mm	BR	2	-	10	

Acero

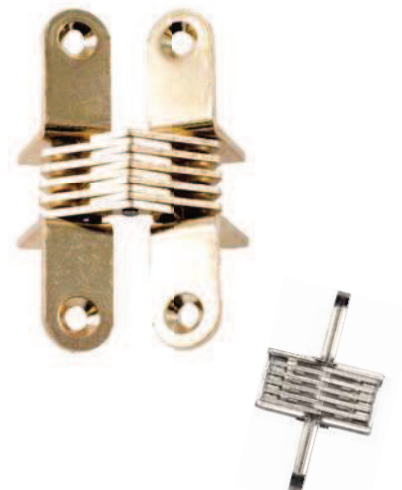
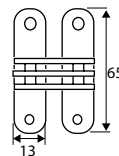

BISAGRA OCULTA BS1

	Código	8431488	Medida Ax B	Acabado				€uros
Caja	65010	650104	10x22 mm	LS	-	10	250	
	65012	650128	12x28 mm	LS	-	10	250	
	65014	650142	14x31 mm	LS	-	10	250	
Blister	91368	913681	10x22 mm	LS	2	-	10	
	91369	913698	12x28 mm	LS	2	-	10	
	91370	913704	14x31 mm	LS	2	-	10	

Latón



65010- C:11
65012- C:14
65014- C:15,5

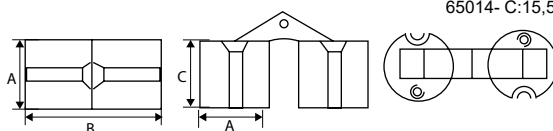

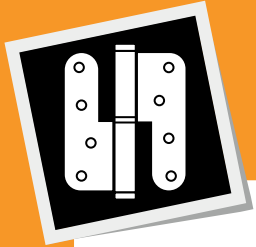

BISAGRA MUEBLE BS5

	Código	8431488	Medida	Acabado				€uros
Caja	67358	673585	26 mm	NI	-	2	50	

Regulación en profundidad 0-2 mm. Ajuste lateral 0 -1 mm
Ajustes vertical 0+2 mm puerta abierta y 2 mm puerta cerrada

Zamak

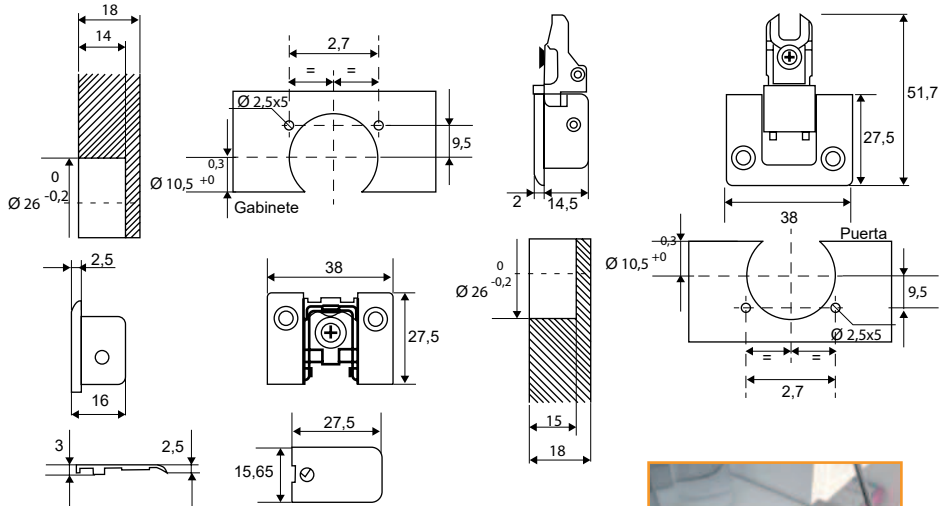

NIQUEL

SUPLEMENTO BISAGRA BS5

	Código	8431488	Medida	Acabado				€uros
Caja	67359	673592	2 mm	NI	-	1	10	
	67360	673608	4 mm	NI	-	1	10	

Zamak

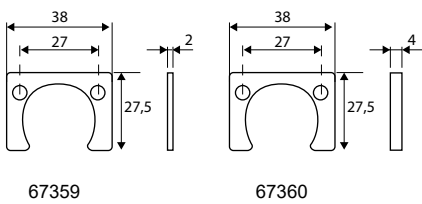

NIQUEL

BISAGRA MOSTRADOR BS19

	Código	8431488	Medida	Acabado				€uros
Caja	67334	673349	80x32x1,5 mm	LTD	-	24	600	
	67335	673356	80x32x1,5 mm	ZN	-	24	600	
Blister	91366	913667	80x32x1,5 mm	LTD	2	-	10	
	91367	913674	80x32x1,5 mm	ZN	2	-	10	

Incluye tornillos en el blister

Acero

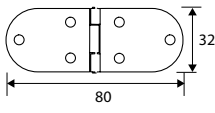

LATONADO ZINCADO

JGO BISAGRA CRISTAL BSC21

	Código	8431488	Medida	Acabado				€uros
Caja	32506	325064	40x18 mm	LTD	-	5	125	
	32507	325071	40x18 mm	CB	-	5	125	
	32508	325088	40x18 mm	NE	-	5	125	
	32509	325095	40x18 mm	NS	-	5	125	
Blister	92266	922669	40x18 mm	LTD	1	-	10	
	92267	922676	40x18 mm	CB	1	-	10	
	92268	922683	40x18 mm	NE	1	-	10	
	92269	922690	40x18 mm	NS	1	-	10	

Zamak

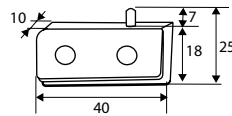
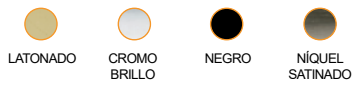

JGO BISAGRA CRISTAL BSC22

	Código	8431488	Medida	Acabado				€uros
	32510	325101	83x30 mm	NI	-	1	5	
Blister	92300	923000	83x30 mm	NI	1	-	10	

Zamak

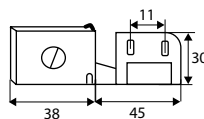

JGO BISAGRA CRISTAL BSC23

	Código	8431488	Medida	Acabado				€uros
	32520	325200	50x25 mm	CB	-	10	50	
Blister	92325	923253	50x25 mm	CB	1	-	10	

Zamak



Código de barras individual

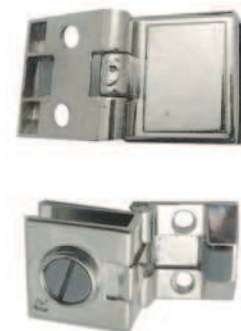
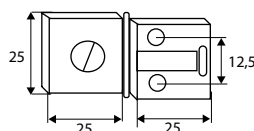

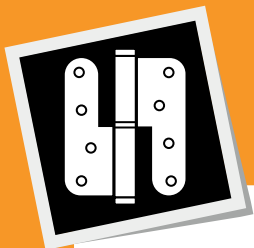

BISAGRA 5005 BS27

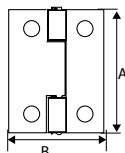
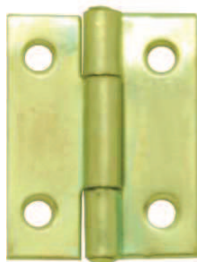
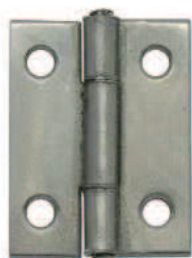

	Código	8431488	Medida AxB	Acabado				€uros
Caja	67252	672526	3/4" 19x15 mm	PU	-	24	600	
	67253	672533	1" 25x20 mm	PU	-	24	600	
	67254	672540	1"1/4 31x22 mm	PU	-	24	600	
	67255	672557	1"1/2 37x26 mm	PU	-	24	600	
	67256	672564	1"3/4 43x28 mm	PU	-	24	600	
	67257	672571	2" 50x30 mm	PU	-	24	600	
	67258	672588	2"1/4 56x31 mm	PU	-	24	600	
	67259	672595	2"1/2 63x32 mm	PU	-	24	600	
	67260	672601	2"3/4 69x36 mm	PU	-	24	240	
	67261	672618	3" 75x42 mm	PU	-	24	240	
	67262	672625	3"1/2 87x49 mm	PU	-	24	240	
	67263	672632	4" 100x53 mm	PU	-	24	120	
	67264	672649	3/4" 19x15 mm	ZN	-	24	600	
	67265	672656	1" 25x20 mm	ZN	-	24	600	
	67266	672663	1"1/4 31x22 mm	ZN	-	24	600	
	67267	672670	1"1/2 37x26 mm	ZN	-	24	600	
	67268	672687	1"3/4 43x28 mm	ZN	-	24	600	
	67269	672694	2" 50x30 mm	ZN	-	24	600	
	67270	672700	2"1/4 56x31 mm	ZN	-	24	600	
	67271	672717	2"1/2 63x32 mm	ZN	-	24	600	
	67272	672724	2"3/4 69x36 mm	ZN	-	24	240	
	67273	672731	3" 75x42 mm	ZN	-	24	240	
	67274	672748	3"1/2 87x49 mm	ZN	-	24	240	
	67275	672755	4" 100x53 mm	ZN	-	24	120	
	67336	673363	3/4" 19x15 mm	LTD	-	24	600	
	67337	673370	1" 25x20 mm	LTD	-	24	600	
	67338	673387	1"1/4 31x22 mm	LTD	-	24	600	
	67339	673394	1"1/2 37x26 mm	LTD	-	24	600	
	67340	673400	1"3/4 43x28 mm	LTD	-	24	600	
	67341	673417	2" 50x30 mm	LTD	-	24	600	
	67342	673424	2"1/4 56x31 mm	LTD	-	24	600	
	67343	673431	2"1/2 63x32 mm	LTD	-	24	600	
	67344	673448	2"3/4 69x36 mm	LTD	-	24	240	
	67345	673455	3" 75x42 mm	LTD	-	24	240	
	67346	673462	3"1/2 87x49 mm	LTD	-	24	240	
	67347	673479	4" 100x53 mm	LTD	-	24	120	
	Blister	91340	913407	1" 25x20 mm	ZN	4	-	10
91341		913414	1"1/2 37x26 mm	ZN	4	-	10	
91342		913421	2" 50x30 mm	ZN	2	-	10	
91343		913438	2"1/2 63x32 mm	ZN	2	-	10	
91344		913445	3" 75x42 mm	ZN	2	-	10	
91381		913810	1" 25x20 mm	LTD	4	-	10	
91382		913827	1"1/2 37x26 mm	LTD	4	-	10	
91383		913834	2" 50x30 mm	LTD	2	-	10	
91384		913841	2"1/2 63x32 mm	LTD	2	-	10	
91385		913858	3" 75x42 mm	LTD	2	-	10	

Incluye tornillos en el blister

Acero



HIERRO
PULIDO



ZINCADO



LATONADO

BISAGRA RAMAL BS28

	Código	8431488	Medida AxB	Acabado			€uros
Caja	67276	672762	2" 22x50 mm	PU	-	24	600
	67277	672779	2"1/2 22x63 mm	PU	-	24	600
	67278	672786	3" 25x75 mm	PU	-	24	600
	67279	672793	4" 25x100 mm	PU	-	24	600
	67280	672809	5" 27x125 mm	PU	-	24	240
	67281	672816	6" 27x150 mm	PU	-	24	240
	67282	672823	2" 22x50 mm	ZN	-	24	600
	67283	672830	2"1/2 22x63 mm	ZN	-	24	600
	67284	672847	3" 25x75 mm	ZN	-	24	600
	67285	672854	4" 25x100 mm	ZN	-	24	600
	67286	672861	5" 27x125 mm	ZN	-	24	240
	67287	672878	6" 27x150 mm	ZN	-	24	240
Blister	91345	913452	2" 22x50 mm	ZN	4	-	10
	91346	913469	2"1/2 22x63 mm	ZN	2	-	10
	91347	913476	3" 25x75 mm	ZN	2	-	10
	91348	913483	4" 25x100 mm	ZN	2	-	10

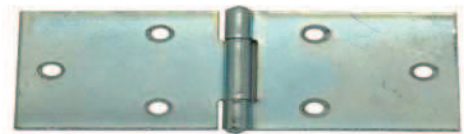
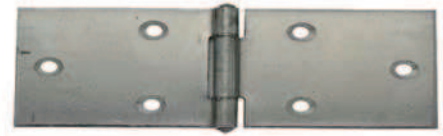

Acero



Incluye tornillos en el blister

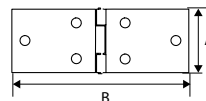

BISAGRA 814 BS29

	Código	8431488	Medida AxB	Acabado			€uros	
Caja	67288	672885	3/4" 22x64 mm	PU	-	24	600	
	67289	672892	1" 25x76 mm	PU	-	24	600	
	67290	672908	1"1/4 31x84 mm	PU	-	24	600	
	67291	672915	1"1/2 37x90 mm	PU	-	24	240	
	67292	672922	1"3/4 43x102 mm	PU	-	24	240	
	67293	672939	2" 50x112 mm	PU	-	24	240	
	67294	672946	2"1/4 56x130 mm	PU	-	12	120	
	67295	672953	2"1/2 63x150 mm	PU	-	12	60	
	67296	672960	3" 75x175 mm	PU	-	12	60	
	67297	672977	3/4" 22x64 mm	ZN	-	24	600	
	67298	672984	1" 25x76 mm	ZN	-	24	600	
	67299	672991	1"1/4 31x84 mm	ZN	-	24	600	
	67300	673004	1"1/2 37x90 mm	ZN	-	24	240	
	67301	673011	1"3/4 43x102 mm	ZN	-	24	240	
	67302	673028	2" 50x112 mm	ZN	-	24	240	
	67303	673035	2"1/4 56x130 mm	ZN	-	12	120	
	67304	673042	2"1/2 63x150 mm	ZN	-	12	60	
	67305	673059	3" 75x175 mm	ZN	-	12	60	
	Blister	91349	913490	3/4" 22x64 mm	ZN	4	-	10
		91350	913506	1" 25x76 mm	ZN	4	-	10
91351		913513	1"1/4 31x84 mm	ZN	2	-	10	
91352		913520	1"1/2 37x90 mm	ZN	2	-	10	
91353		913537	1"3/4 43x102 mm	ZN	2	-	10	

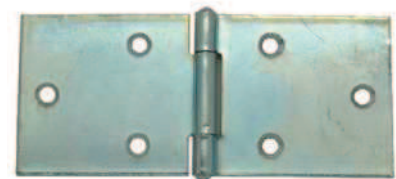

Acero



Incluye tornillos en el blister

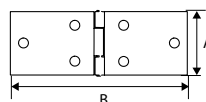

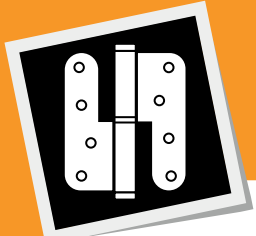

BISAGRA 816 BS30

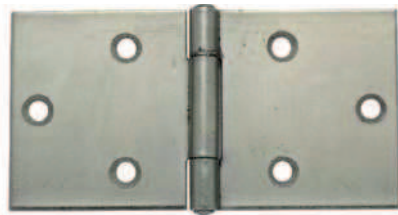

	Código	843 I 488	Medida AxB	Acabado				€uros
Caja	67306	673066	1" 22x50 mm	PU	-	24	600	
	67307	673073	1"1/4 31x57 mm	PU	-	24	600	
	67308	673080	1"1/2 37x70 mm	PU	-	24	240	
	67309	673097	1"3/4 43x78 mm	PU	-	24	240	
	67310	673103	2" 50x95 mm	PU	-	24	240	
	67311	673110	2"1/4 56x103 mm	PU	-	12	120	
	67312	673127	2"1/2 63x120 mm	PU	-	12	120	
	67313	673134	1" 22x50 mm	ZN	-	24	600	
	67314	673141	1"1/4 31x57 mm	ZN	-	24	600	
	67315	673158	1"1/2 37x70 mm	ZN	-	24	240	
	67316	673165	1"3/4 43x78 mm	ZN	-	24	240	
	67317	673172	2" 50x95 mm	ZN	-	24	240	
Blister	91354	913544	1" 22x50 mm	ZN	4	-	10	
	91355	913551	1"1/4 31x57 mm	ZN	2	-	10	
	91356	913568	1"1/2 37x70 mm	ZN	2	-	10	
	91357	913575	1"3/4 43x78 mm	ZN	2	-	10	
	91358	913582	2" 50x95 mm	ZN	2	-	10	
	91359	913599	2"1/4 56x103 mm	ZN	2	-	10	

Incluye tornillos en el blister

Acero

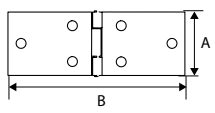

BISAGRA 840 BS31

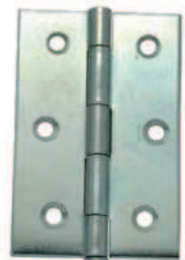

	Código	843 I 488	Medida AxB	Acabado				€uros
Caja	67320	673202	3" 75x49 mm	PU	-	24	240	
	67321	673219	3"1/2 87x55 mm	PU	-	24	120	
	67322	673226	4" 100x70 mm	PU	-	24	120	
	67323	673233	4"1/2 112x75 mm	PU	-	12	60	
	67324	673240	5" 125x85 mm	PU	-	12	60	
	67325	673257	3" 75x49 mm	ZN	-	24	240	
	67326	673264	3"1/2 87x55 mm	ZN	-	24	120	
	67327	673271	4" 100x70 mm	ZN	-	24	120	
	67328	673288	4"1/2 112x75 mm	ZN	-	12	60	
	67329	673295	5" 125x85 mm	ZN	-	12	60	
Blister	91360	913605	3" 75x49 mm	ZN	2	-	10	
	91361	913612	3"1/2 87x55 mm	ZN	2	-	10	
	91362	913629	4" 100x70 mm	ZN	2	-	10	

Incluye tornillos en el blister

Acero

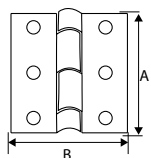

BISAGRA ESTUCHE BS22

	Código	8431488	Medida AxB	Acabado				€uros
Caja	30615	306155	13x15 mm	LP	-	200	5000	
	30620	306209	13x20 mm	LP	-	200	5000	
	30625	306254	13x25 mm	LP	-	200	5000	
Blister	90305	903057	13x15 mm	LP	6	-	10	
	90306	903064	13x20 mm	LP	6	-	10	
	90307	903071	13x25 mm	LP	4	-	10	

Acero

Incluye puntas en el blister

LATÓN PULIDO

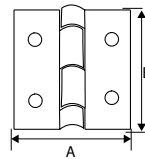
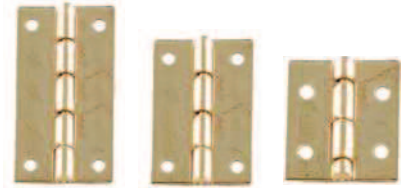

CIERRE ESTUCHE CC11

	Código	8431488	Medida	Acabado				€uros
Caja	30725	307251	25 mm	LP	-	50	1250	
Blister	90308	903088	25 mm	LP	2	-	10	

Acero

Incluye puntas en el blister

LATÓN PULIDO

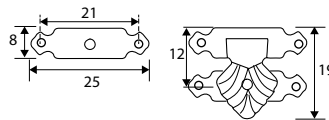

BISAGRA BS22 + CIERRE ESTUCHE CC11

	Código	8431488	Medida	Acabado				€uros
Blister	90309	903095	13x15 + 25 mm	LP	3 + 1	-	10	
	90310	903101	13x20 + 25 mm	LP	3 + 1	-	10	
	90311	903118	13x25 + 25 mm	LP	3 + 1	-	10	

Acero

Incluye puntas en el blister

LATÓN PULIDO

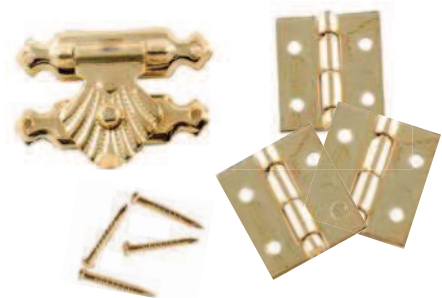

PUNTAS DE LATÓN PNT2

	Código	8431488	Medida AxB	Acabado				€uros
Caja	80026	800264	1,2x11 mm	LT	-	1000	-	
	80027	800271	1,5x13 mm	LT	-	1000	-	
	80028	800288	1,5x18 mm	LT	-	1000	-	
Blister	90312	903125	1,2x11 mm	LT	50	-	10	
	90313	903132	1,5x13 mm	LT	40	-	10	
	90314	903149	1,5x18 mm	LT	20	-	10	

Latón

LATÓN

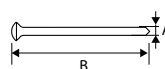

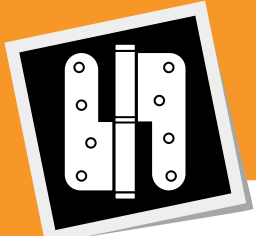

BISAGRA PIANO BS21 (TIRA)

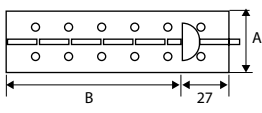

Código	8431488	Medida AxB	Acabado				€uros
33201	332017	32x480 mm	LTD	1	-	10	
33202	332024	32x720 mm	LTD	1	-	10	
33203	332031	32x960 mm	LTD	1	-	10	
33204	332048	32x480 mm	NI	1	-	10	
33205	332055	32x720 mm	NI	1	-	10	
33206	332062	32x960 mm	NI	1	-	10	

Incluye agujero colgador

Acero



BISAGRA PIANO BS32 (ROLLO)

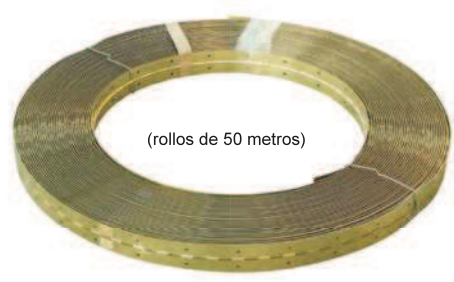

(rollos de 50 metros)

Código	8431488	Medida A	Acabado				€uros
33207	332079	20 mm	LTD	-	1	7	
33250	332505	32 mm	LTD	-	1	6	
34050	340500	40 mm	LTD	-	1	5	
33208	332086	20 mm	NI	-	1	7	
33251	332512	32 mm	NI	-	1	6	
34051	340517	40 mm	NI	-	1	5	
33252	332529	32 mm	INOX	-	1	6	
34052	340524	40 mm	INOX	-	1	5	

LTD-NI: Acero
INOX: Acero Inoxidable

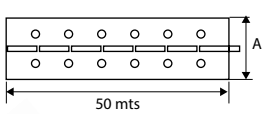
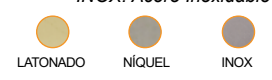

BISAGRA FORMA "T" BS23



código	A	B	C	D
19310/19410	109	75	38	11,5
19313/19413	138	88	38	11,5
19315/19415	155	88	38	11,5
19317/19417	188	88	38	11,5
19320/19420	207	111	45	12,5
19325/19425	262	111	45	12,5
19330/19430	312	111	45	12,5

Código	8431488	Medida	Acabado				€uros
19310	193106	100 mm	ZN	-	10	100	
19313	193137	130 mm	ZN	-	10	100	
19315	193151	150 mm	ZN	-	10	50	
19317	193175	175 mm	ZN	-	10	50	
19320	193205	200 mm	ZN	-	10	50	
19325	193250	250 mm	ZN	-	10	50	
19330	193304	300 mm	ZN	-	10	50	
19410	194103	100 mm	NE	-	10	100	
19413	194134	130 mm	NE	-	10	100	
19415	194158	150 mm	NE	-	10	50	
19417	194172	175 mm	NE	-	10	50	
19420	194202	200 mm	NE	-	10	50	
19425	194257	250 mm	NE	-	10	50	
19430	194301	300 mm	NE	-	10	50	
92418	924182	100 mm	ZN	1	-	10	
92419	924199	130 mm	ZN	1	-	10	
92420	924205	150 mm	ZN	1	-	10	
92421	924212	175 mm	ZN	1	-	10	
92422	924229	100 mm	NE	1	-	10	
92423	924236	130 mm	NE	1	-	10	
92424	924243	150 mm	NE	1	-	10	
92425	924250	175 mm	NE	1	-	10	

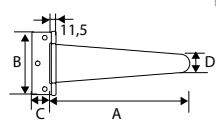

BISAGRA FORMA "T" BS8

	Código	8431488	Medida AxBxCxD	Acabado				€uros
Caja	36016	360164	75x75x25x20 mm	NE	-	10	100	
	36017	360171	100x95x28x25 mm	NE	-	10	100	
Blister	91511	915111	75x75x25x20 mm	NE	2	-	10	
	91512	915128	100x95x28x25 mm	NE	2	-	10	

Acero



NEGRO

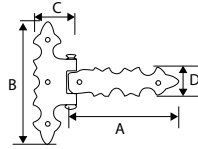

BISAGRA ALAS BS6

	Código	8431488	Medida	Acabado				€uros
Caja	36013	360133	80x65 mm	NE	-	10	100	
Blister	91508	915081	80x65 mm	NE	2	-	10	

Acero



NEGRO

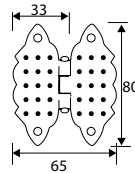

BISAGRA ALAS BS7

	Código	8431488	Medida AxBxC	Acabado				€uros
Caja	36014	360140	75x45x25 mm	NE	-	10	100	
	36015	360157	95x60x30 mm	NE	-	10	100	
Blister	91509	915098	75x45x25 mm	NE	2	-	10	
	91510	915104	95x60x30 mm	NE	2	-	10	

Acero



NEGRO

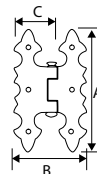

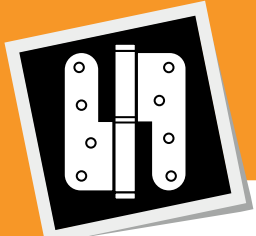

BISAGRA SOLAPADA C/REMATE BS24



	Código	843 1488	Medida A	Acabado				€uros
Caja	36007	360072	40 mm	LTD	-	25	250	
	36008	360089	40 mm	CB	-	25	250	
	36009	360096	40 mm	LE	-	25	250	
	36010	360102	53 mm	LTD	-	25	250	
	36011	360119	53 mm	CB	-	25	250	
	36012	360126	53 mm	LE	-	25	250	
Blister	90936	909363	40 mm	LTD	2	-	10	
	90937	909370	40 mm	CB	2	-	10	
	90938	909387	40 mm	LE	2	-	10	
	90939	909394	53 mm	LTD	2	-	10	
	90940	909400	53 mm	CB	2	-	10	
	90941	909417	53 mm	LE	2	-	10	

Incluye tornillos en el blister

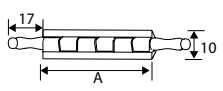

Zamak

LATONADO
 CROMO BRILLO
 LATÓN ENVEJECIDO

BISAGRA SOLAPADA S/REMATE BS25



	Código	843 1488	Medida A	Acabado				€uros
Caja	36001	360010	40 mm	LTD	-	25	625	
	36002	360027	40 mm	CB	-	25	625	
	36003	360034	40 mm	LE	-	25	625	
	36004	360041	53 mm	LTD	-	25	625	
	36005	360058	53 mm	CB	-	25	625	
	36006	360065	53 mm	LE	-	25	625	
Blister	90942	909424	40 mm	LTD	2	-	10	
	90943	909431	40 mm	CB	2	-	10	
	90944	909448	40 mm	LE	2	-	10	
	90945	909455	53 mm	LTD	2	-	10	
	90946	909462	53 mm	CB	2	-	10	
	90947	909479	53 mm	LE	2	-	10	

Incluye tornillos en el blister

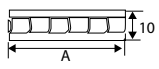

Zamak

LATONADO
 CROMO BRILLO
 LATÓN ENVEJECIDO

BISAGRA BIOMBO BS20

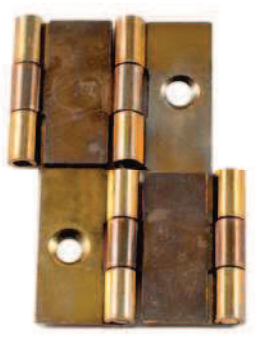

	Código	843 1488	Medida AxBxC	Acabado				€uros
Caja	67330	673301	50x20x0,9 mm	LTD	-	24	600	
	67331	673318	60x25x1,2 mm	LTD	-	24	240	
	67332	673325	60x30x1,5 mm	LTD	-	24	240	
Blister	91363	913636	50x20x0,9 mm	LTD	2	-	10	
	91364	913643	60x25x1,2 mm	LTD	2	-	10	
	91365	913650	60x30x1,5 mm	LTD	2	-	10	

Incluye tornillos en el blister

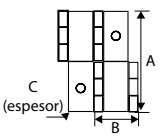

Acero

LATONADO

BISAGRA CAZOLETA 26 MM BC1

	Código	8431488	Tipo	Acabado				€uros
Caja	19221	192215	recta	ZN	-	24	240	
	19222	192222	acodada	ZN	-	24	240	
	19223	192239	superacodada	ZN	-	24	240	
Blister	90491	904917	recta	ZN	2	-	10	
	90492	904924	acodada	ZN	2	-	10	
	90493	904931	superacodada	ZN	2	-	10	

Acero



ZINCADO



Presentación en bolsa de 2 unidades

Incluye tornillos en el blister
 Incluye base



BISAGRA CAZOLETA 35MM BC2

	Código	8431488	Tipo	Acabado				€uros
Caja	19201	192017	recta	ZN	-	24	240	
	19202	192024	acodada	ZN	-	24	240	
	19203	192031	superacodada	ZN	-	24	240	
Blister	90494	904948	recta	ZN	2	-	10	
	90495	904955	acodada	ZN	2	-	10	
	90496	904962	superacodada	ZN	2	-	10	

Acero



ZINCADO



Presentación en bolsa de 2 unidades

Incluye tornillos en el blister
 Incluye base



BISAGRA CAZOLETA CLIP 35 MM BC3

	Código	8431488	Tipo	Acabado				€uros
Caja	19211	192116	recta	ZN	-	24	192	
	19212	192123	acodada	ZN	-	24	192	
	19213	192130	superacodada	ZN	-	24	192	
Blister	90497	904979	recta	ZN	2	-	10	
	90498	904986	acodada	ZN	2	-	10	
	90499	904993	superacodada	ZN	2	-	10	

Acero



ZINCADO



Presentación en bolsa de 2 unidades

Incluye tornillos en el blister
 Incluye base



BISAGRA CAZOLETA CLIP C/TETÓN 35 MM BC4

	Código	8431488	Tipo	Acabado				€uros
Caja	19214	192147	recta	ZN	-	24	240	
	19215	192154	acodada	ZN	-	24	240	
	19216	192161	superacodada	ZN	-	24	240	

Acero



ZINCADO



Presentación en bolsa de 2 unidades

Incluye base
Tetón cazoleta D10 mm x L10,5 mm
Tetón base D5 mm x L5 mm



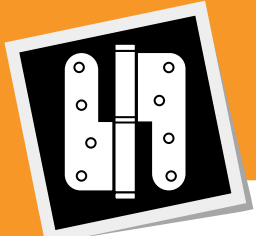

BISAGRA CAZOLETA C/PISTÓN 35 MM BC5



	Código	843 I 488	Tipo	Acabado				€uros
Caja	19241	192413	recta	ZN	-	24	96	
	19242	192420	acodado	ZN	-	24	96	
	19243	192437	superacodada	ZN	-	24	96	
Blister	90501	905013	recta	ZN	2	-	10	
	90502	905020	acodado	ZN	2	-	10	
	90503	905037	superacodada	ZN	2	-	10	

Incluye tornillos en el blister
 Incluye base - Base triple regulación
 Incluye tapa embellecedora

Acero

 ZINCADO



Presentación en bolsa de 2 unidades



BISAGRA CAZOLETA C/PISTÓN Y TETÓN 35 MM BC6

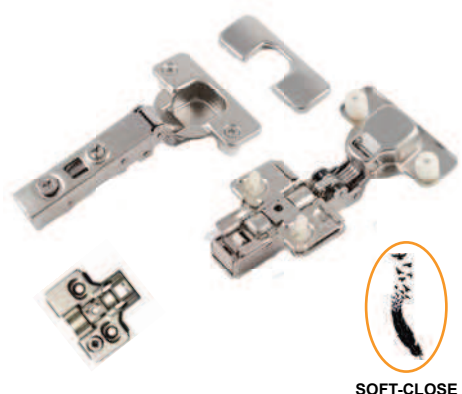

	Código	843 I 488	Tipo	Acabado				€uros
Caja	19217	192178	recta	ZN	-	24	240	
	19218	192185	acodada	ZN	-	24	240	
	19219	192192	superacodada	ZN	-	24	240	

Incluye base - Base triple regulación
 Incluye tapa embellecedora
 Tetón cazoleta D10 mm x L10,5 mm
 Tetón base D5 mm x L5 mm

Acero

 ZINCADO



Presentación en bolsa de 2 unidades



BISAGRA CAZOLETA PUSH 35 MM BC11

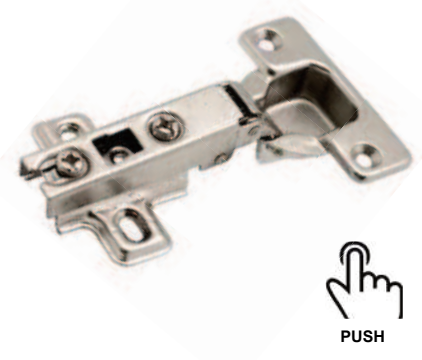

	Código	843 I 488	Tipo	Acabado				€uros
Caja	19234	192345	recta	ZN	-	24	240	
	19235	192352	acodada	ZN	-	24	240	
	19236	192369	superacodada	ZN	-	24	240	

Incluye base
 Sistema de apertura de expulsión, es necesario montar con un toca-toca o expulsor para mantener la puerta cerrada

Acero

 ZINCADO



Presentación en bolsa de 2 unidades



BISAGRA CAZOLETA CLIP 165° 35 MM BC7



	Código	843 I 488	Tipo	Acabado				€uros
Caja	19224	192246	recta	ZN	-	12	96	
	19229	192291	acodada	ZN	-	12	96	
	19230	192307	superacodada	ZN	-	12	96	

Incluye base

Acero

 ZINCADO



Presentación en bolsa de 1 unidad



BISAGRA CAZOLETA 30° BC8

	Código	8431488	Medida	Acabado				€uros
Caja	19225	192253	35 mm	ZN	-	24	192	
Blister	91686	916866	35 mm	ZN	2	-	10	

Acero



ZINCADO



Presentación en bolsa de 2 unidades



Incluye tornillos en el blister
Incluye base



BISAGRA CAZOLETA 45° BC9

	Código	8431488	Medida	Acabado				€uros
Caja	19226	192260	35 mm	ZN	-	24	240	
Blister	91687	916873	35 mm	ZN	2	-	10	

Acero



ZINCADO



Presentación en bolsa de 2 unidades



Incluye tornillos en el blister
Incluye base



BISAGRA CAZOLETA 90° RINCONERA BC12

	Código	8431488	Medida	Acabado				€uros
Caja	19237	192376	35 mm	ZN	-	24	192	
Blister	91872	918723	35 mm	ZN	2	-	10	

Acero



ZINCADO



Presentación en bolsa de 2 unidades



Incluye tornillos en el blister
Incluye base

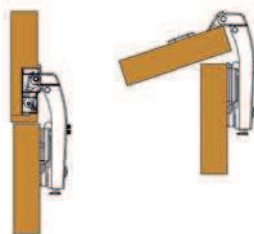

BISAGRA CAZOLETA 90° RINCONERA C/PISTÓN BC13

	Código	8431488	Medida	Acabado				€uros
Caja	19238	192383	35 mm	ZN	-	24	96	
Blister	92183	921839	35 mm	ZN	2	-	10	

Acero



ZINCADO



Presentación en bolsa de 2 unidades



Incluye tornillos en el blister
Incluye base - Base triple regulación



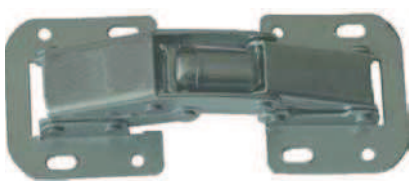
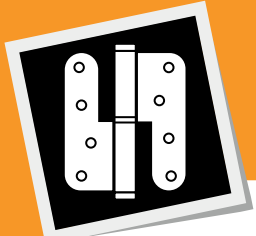

BISAGRA CAZOLETA SOBREPONER BC10

	Código	8431488	Tipo	Acabado				€uros
Caja	10092	109213	104x44 mm	ZN	-	25	250	
Blister	90504	905044	104x44 mm	ZN	2	-	10	

Incluye tornillos en el blister

Acero

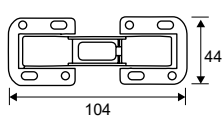

BASE AVIÓN CLIPTRIPLE REGULACIÓN BC5

	Código	8431488	Tipo	Acabado				€uros
Caja	19228	192284	53x46 mm	ZN	-	50	500	

Acero

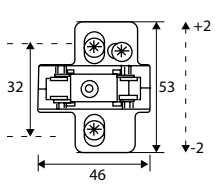

TAPA EMBELLECEDOR BC5

	Código	8431488	Tipo	Acabado				€uros
Caja	19227	192277	63x22 mm	ZN	-	100	1000	

Acero

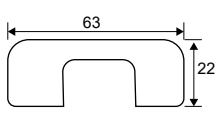

TORNILLO BISAGRA TRN5

	Código	8431488	Medida	Acabado				€uros
Caja	43516	435169	3,5x16 mm	NI	-	1000	10000	
	44016	440163	4,0x16 mm	NI	-	1000	10000	
Blister	90209	902098	3,5x16 mm	NI	20	-	10	
	90210	902104	4,0x16 mm	NI	20	-	10	

Acero

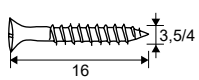

Te sugiero:

TORNILLO Q EURO
Pág. 277

TAPÓN BISAGRA
Pág. 262





TIRADOR TRM1

	Código	8431488	Medida	Acabado				€uros
Caja	22032	220321	128 mm	NS	-	10	50	

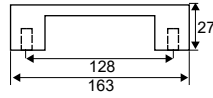

Zamak



TIRADOR TRM2

	Código	8431488	Medida	Acabado				€uros
Caja	22014	220147	160 mm	CM	-	10	60	

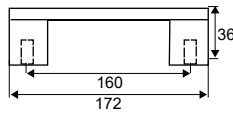

Aluminio



TIRADOR TRM4

	Código	8431488	Medida	Acabado				€uros
Caja	22042	220420	160 mm	CB	-	10	50	
	22043	220437	160 mm	CM	-	10	50	
	22044	220444	160 mm	NS	-	10	50	

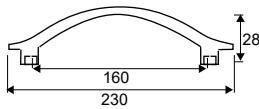

Zamak



TIRADOR TRM5

	Código	8431488	Medida	Acabado				€uros
Caja	22021	220215	128 mm	CB	-	10	100	
	22022	220222	128 mm	CM	-	10	100	
	22023	220239	128 mm	NS	-	10	100	

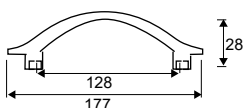

Zamak



TIRADOR TRM6

	Código	8431488	Medida A/B	Acabado				€uros
Caja	26032	260327	32/52 mm	CM	-	10	100	
	26064	260648	64/84 mm	CM	-	10	100	
	26128	261287	128/148 mm	CM	-	10	50	
	26160	261607	160/180 mm	CM	-	10	60	

Aluminio

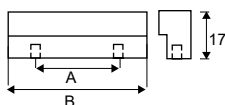

TIRADOR CARRUSEL TRM7

	Código	8431488	Medida A/B	Acabado				€uros
Caja	22006	220062	64/74 mm	INOX	-	10	100	
	22007	220079	96/106 mm	INOX	-	10	100	
	22008	220086	128/138 mm	INOX	-	10	100	

Acero Inoxidable

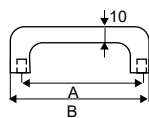

TIRADOR ARCO TRM8

	Código	8431488	Medida	Acabado				€uros
Caja	22001	220017	128/146 mm	INOX	-	10	100	

Acero Inoxidable

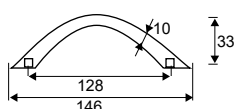

TIRADOR VARILLA TRM9

	Código	8431488	Medida A/B	Acabado				€uros
Caja	24096	240961	96 mm/160 mm	INOX	-	10	100	
	24128	241289	128 mm/188 mm	INOX	-	10	100	
	24160	241609	160 mm/220 mm	INOX	-	10	50	
	24192	241920	192 mm/252 mm	INOX	-	10	50	
	24256	242569	256 mm/336 mm	INOX	-	10	50	
	24320	243207	320 mm/400 mm	INOX	-	10	50	
	24384	243849	384 mm/464 mm	INOX	-	10	-	
	24448	244488	448 mm/528 mm	INOX	-	10	-	
	24512	245126	512 mm/592 mm	INOX	-	10	-	

Acero Inoxidable

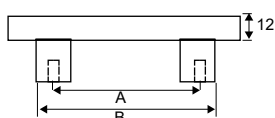



TIRADOR TRM20

	Código	8431488	Medida	Acabado				€uros
Caja	22060	220604	128 mm	INOX	-	10	60	

Acero Inoxidable

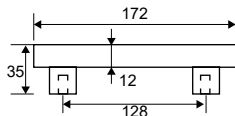

TIRADOR TRM17

	Código	8431488	Medida A/B	Acabado				€uros
Caja	22049	220499	128/140 mm	INOX	-	10	60	
	22050	220505	192/204 mm	INOX	-	10	60	
	22051	220512	256/268 mm	INOX	-	10	60	
	22052	220529	320/332 mm	INOX	-	10	60	

Acero Inoxidable

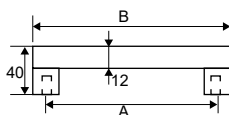

TIRADOR TRM18

	Código	8431488	Medida A/B	Acabado				€uros
Caja	22053	220536	160/172 mm	INOX	-	10	60	
	22054	220543	192/204 mm	INOX	-	10	60	
	22055	220550	256/268 mm	INOX	-	10	60	
	22056	220567	320/332 mm	INOX	-	10	60	

Acero Inoxidable

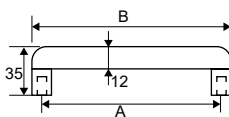

TIRADOR TRM19

	Código	8431488	Medida A/B	Acabado				€uros
Caja	22057	220574	160/172 mm	INOX	-	10	60	
	22058	220581	192/204 mm	INOX	-	10	60	
	22059	220598	256/268 mm	INOX	-	10	60	

Acero Inoxidable

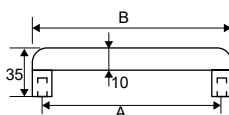

TIRADOR TRM16

	Código	8431488	Medida	Acabado				€uros
Caja	22048	220482	192 mm	INOX	-	10	60	

Acero Inoxidable

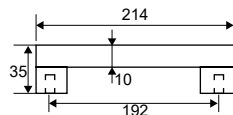

POMO ARMARIO CILÍNDRICO PA15

	Código	8431488	Medida	Acabado				€uros
Caja	21285	212852	20 mm	INOX	-	10	250	
	21286	212869	25 mm	INOX	-	10	250	

Acero Inoxidable

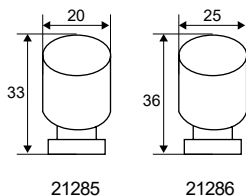

POMO ARMARIO CÓNICO PA7

	Código	8431488	Medida	Acabado				€uros
Caja	21277	212777	12 mm	INOX	-	10	250	
	21278	212784	20 mm	INOX	-	10	250	

Acero Inoxidable

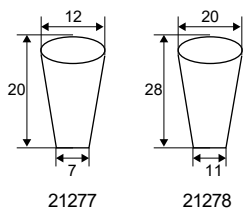

POMO ARMARIO PLANO PA8

	Código	8431488	Medida	Acabado				€uros
Caja	21282	212821	20 mm	INOX	-	10	250	
	21279	212791	30 mm	INOX	-	10	100	

Acero Inoxidable

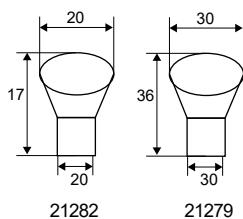



POMO ARMARIO MUESCA PA6

	Código	8431488	Medida	Acabado				€uros
Caja	21273	212739	15 mm	INOX	-	10	250	
	21274	212746	20 mm	INOX	-	10	100	
	21275	212753	25 mm	INOX	-	10	100	

Acero Inoxidable

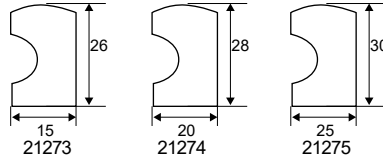

INOX

POMO ARMARIO MUESCA PA12

	Código	8431488	Medida	Acabado				€uros
Caja	20028	200286	20 mm	NS	-	10	100	

Aluminio

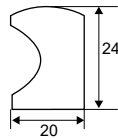

NIQUEL SATINADO

POMO ARMARIO CUADRADO PA4

	Código	8431488	Medida	Acabado				€uros
Caja	81834	818344	16 mm	NS	-	10	250	

Latón

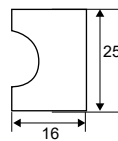

NIQUEL SATINADO

POMO ARMARIO CUADRADO PA14

	Código	8431488	Medida	Acabado				€uros
Caja	21283	212838	20 mm	INOX	-	10	250	
	21284	212845	25 mm	INOX	-	10	250	

Acero Inoxidable

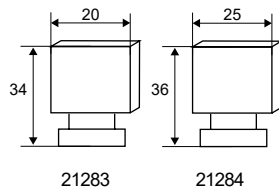

INOX

POMO ARMARIO BOLA PA9

	Código	8431488	Medida	Acabado				€uros
Caja	21270	212708	20 mm	INOX	-	10	250	
	21271	212715	25 mm	INOX	-	10	100	

Acero Inoxidable



INOX

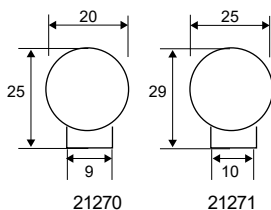

POMO ARMARIO BOLA PA1

	Código	8431488	Medida	Acabado				€uros
Caja	20020	200200	20 mm	LP	-	10	250	
	20202	202020	20 mm	NS	-	10	250	
	20025	200255	25 mm	LP	-	10	100	
	20252	202525	25 mm	NS	-	10	100	
	20253	202532	25 mm	CU	-	10	100	
	20030	200309	30 mm	LP	-	10	100	
	20302	203027	30 mm	NS	-	10	100	

Latón



LATÓN PULIDO



NIQUEL SATINADO



CUERO

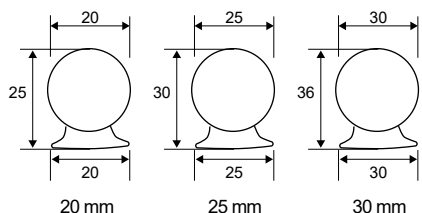

POMO ARMARIO BOLA PA11

	Código	8431488	Medida	Acabado				€uros
Caja	20029	200293	20 mm	LTD	-	10	500	
	20031	200316	20 mm	NS	-	10	500	
	20032	200323	25 mm	LTD	-	10	500	
	20033	200330	25 mm	NS	-	10	500	

Aluminio



LATONADO



NIQUEL SATINADO

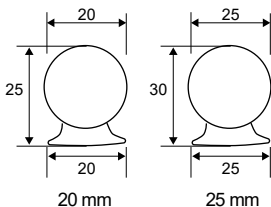

POMO ARMARIO BOLA PA10

	Código	8431488	Medida	Acabado				€uros
Caja	20027	200279	28 mm	NS	-	10	100	

Aluminio



NIQUEL SATINADO

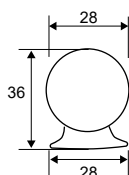



POMO ARMARIO PLANO PA5

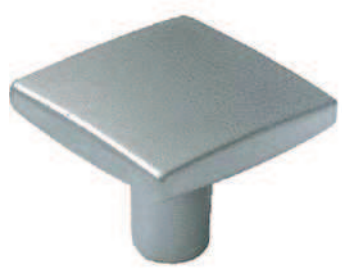

	Código	8431488	Medida	Acabado				€uros
Caja	21280	212807	31 mm	CM	-	10	100	
	21281	212814	31 mm	NS	-	10	100	

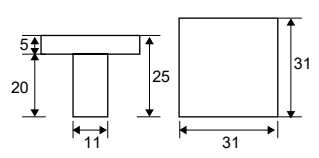

Zamak
 CROMO MATE
 NÍQUEL SATINADO

POMO ARMARIO MARGARITA PA13



	Código	8431488	Medida A	Acabado				€uros
Caja	20034	200347	14 mm	LT	-	10	250	
	20035	200354	16 mm	LT	-	10	250	
	20036	200361	18 mm	LT	-	10	250	
	20037	200378	20 mm	LT	-	10	250	

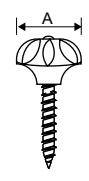

Latón
 LATÓN

ASA COMODILLA TRM10



	Código	8431488	Medida	Acabado				€uros
Caja	27361	273617	36x36 mm	OR	-	10	100	

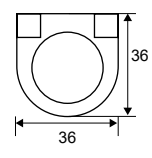

Zamak
 ORO

ASA COMODILLA TRM11



	Código	8431488	Medida	Acabado				€uros
Caja	27801	278018	80x36 mm	OR	-	10	100	
	27802	278025	80x36 mm	CM	-	10	100	
	27803	278032	80x36 mm	CU	-	10	100	

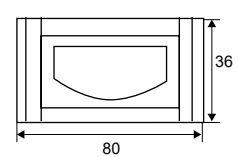

Zamak
 ORO
 CROMO MATE
 CUERO

ASA ABATIBLE LISA TRM12

	Código	8431488	Medida AxB	Acabado				€uros
Caja	10041	104102	100x27 mm	ZN	-	20	200	
	10042	100425	125x27 mm	ZN	-	20	200	
	10043	100432	100x27 mm	BC	-	20	200	
	10044	100449	125x27 mm	BC	-	20	200	
	10038	100388	100x27 mm	NE	-	20	200	
	10039	100395	125x27 mm	NE	-	20	200	
Blister	90512	905129	100x27 mm	ZN	1	-	10	
	90513	905136	125x27 mm	ZN	1	-	10	
	90514	905143	100x27 mm	BC	1	-	10	
	90515	905150	125x27 mm	BC	1	-	10	
	90510	905105	100x27 mm	NE	1	-	10	
	90511	905112	125x27 mm	NE	1	-	10	

Acero

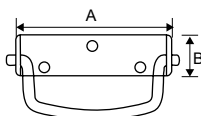

ASA ABATIBLE REFORZADA TRM13

	Código	8431488	Medida	Acabado				€uros
Caja	10047	100470	110 mm	ZN	-	12	60	

Acero

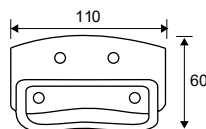

TIRADOR CAJA TRM15

	Código	8431488	Medida AxBxC	Acabado				€uros
Caja	27366	273662	80x66x18,5 mm	NI	-	10	100	
	27367	273679	100x83x21,5 mm	NI	-	10	100	
	27368	273686	120x99x24,5 mm	NI	-	10	100	
	27369	273693	140x121x28,5 mm	NI	-	10	50	
	27370	273709	160x140x29,5 mm	NI	-	10	50	

Acero

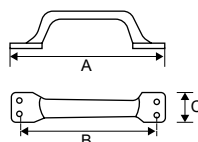

TIRADOR HIERRO TRM14

	Código	8431488	Medida A	Acabado				€uros
Caja	27364	273648	145 mm	ZN	-	10	100	
	27365	273655	170 mm	ZN	-	10	50	

Acero

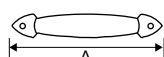



TIRADOR EMBUTIR CUADRADO C/MUELLE TE9



	Código	8431488	Medida	Acabado				€uros
Caja	22069	220697	80x80 mm	INOX	-	10	100	

Acero Inoxidable

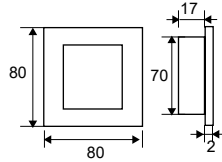

TIRADOR EMBUTIR RECTANGULAR C/MUELLE TE10

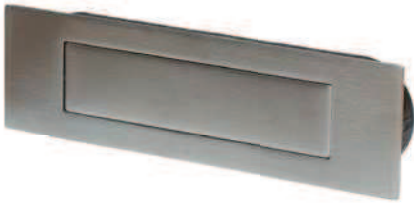

	Código	8431488	Medida	Acabado				€uros
Caja	22070	220703	155x45 mm	INOX	-	10	100	

Acero Inoxidable

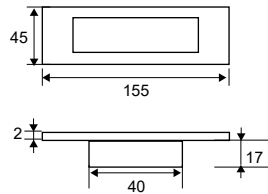

TIRADOR EMBUTIR OVAL C/MUELLE TE11



	Código	8431488	Medida	Acabado				€uros
Caja	22071	220710	155x45 mm	INOX	-	10	100	

Acero Inoxidable

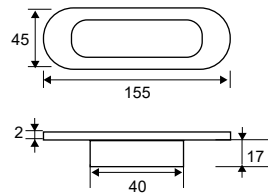

TIRADOR EMBUTIR REDONDO TE5



	Código	8431488	Medida	Acabado				€uros
	22065	220659	65 mm	INOX	-	10	100	

Acero Inoxidable

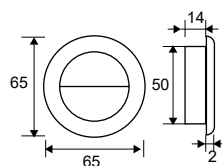

TIRADOR EMBUTIR MEDIA LUNA TE13

	Código	8431488	Medida AxBxC	Acabado			€uros
Caja	22072	220727	40x40x32 mm	INOX	-	10	100
	22073	220734	50x50x42 mm	INOX	-	10	100

Acero Inoxidable

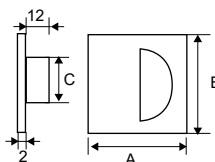

TIRADOR EMBUTIR CUADRADO TE7

	Código	8431488	Medida	Acabado			€uros
	22067	220673	50x50 mm	INOX	-	10	100
	22068	220680	70x70 mm	INOX	-	10	100

Acero Inoxidable



Parte de embutir circular

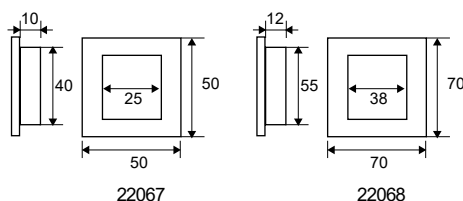

TIRADOR EMBUTIR RECTANGULAR TE8

	Código	8431488	Medida	Acabado			€uros
	22066	220666	150x50 mm	INOX	-	10	100

Acero Inoxidable



Parte de embutir cuadrada

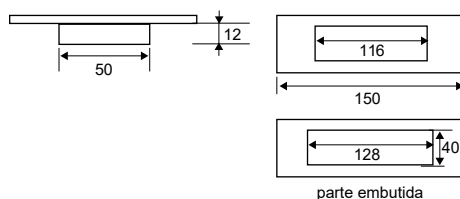

TIRADOR EMBUTIR OVAL TE6

	Código	8431488	Medida	Acabado			€uros
	22120	221205	120x40 mm	INOX	-	10	100

Acero Inoxidable

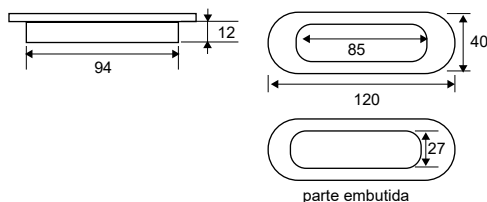



TIRADOR EMBUTIR UÑERO CUADRADO TE4



Código	8431488	Medida	Acabado				€uros
48701	487014	19 mm	LP	-	1	10	
48702	487021	19 mm	NS	-	1	10	

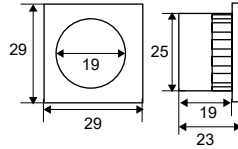

Latón



TIRADOR EMBUTIR UÑERO TE2



Código	8431488	Medida	Acabado				€uros
48201	482019	19 mm	LP	-	1	10	
48202	482026	19 mm	NS	-	1	10	
48203	482033	19 mm	CU	-	1	10	
48208	482088	19 mm	NE	-	1	10	

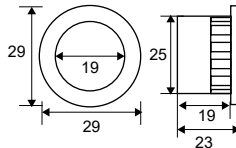

Latón



TIRADOR EMBUTIR CUADRADO TE3



Código	8431488	Medida	Acabado				€uros
48601	486017	45 mm	LP	-	1	10	
48602	486024	45 mm	NS	-	1	10	

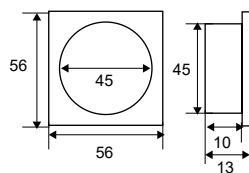

Latón



TIRADOR EMBUTIR TE1

Código	8431488	Medida	Acabado				€uros
48101	481012	45 mm	LP	-	1	10	
48102	481029	45 mm	NS	-	1	10	
48103	481036	45 mm	CU	-	1	10	
48108	481081	45 mm	NE	-	1	10	

Latón

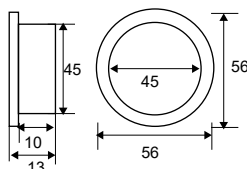
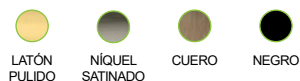

TIRADOR EMBUTIR OVAL TE12

Código	8431488	Medida	Acabado				€uros
<i>Caja</i> 69421	694214	152x38 mm	LP	-	10	50	
69424	694245	152x38 mm	NS	-	10	50	

Latón

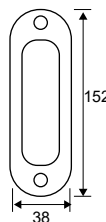
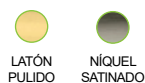

Te sugiero:

JGO TIRADOR REDONDO
PCR1 - Pág. 147



JGO TIRADOR RECTO
PCR1 - Pág. 147



TIRADOR EMBUTIR
PCR1 - Pág. 147



KIT PUERTA CORREDERA
PCR3 - Pág. 170



KIT PUERTA CORREDERA
CUADRADO PCR4 - Pág. 171



KIT PUERTA CORREDERA
BOCALLAVE PCR5 - Pág. 171



TORNILLO MULTICORTE TRN7



	Código	8431488	Medida	Acabado				€uros
Caja	30445	304458	M4x45 mm	BC	-	100	1000	
	30446	304465	M4x45 mm	ZN	-	100	1000	
Blister	90204	902043	M4x45 mm	BC	12	-	10	
	90642	906423	M4x45 mm	ZN	12	-	10	

7 Cortes

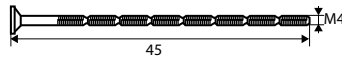

Acero



TORNILLO TIRADOR TRN8



	Código	8431488	Medida M4xB	Acabado				€uros
Caja	30480	304809	M4x8 mm	ZN	-	1000	18000	
	30410	304106	M4x10 mm	ZN	-	1000	12000	
	30414	304144	M4x14 mm	ZN	-	1000	12000	
	30420	304205	M4x20 mm	ZN	-	1000	8000	
	30422	304229	M4x22 mm	ZN	-	1000	8000	
	30425	304250	M4x25 mm	ZN	-	1000	8000	
	30428	304281	M4x28 mm	ZN	-	1000	8000	
	30430	304304	M4x30 mm	ZN	-	1000	6000	
	30435	304359	M4x35 mm	ZN	-	1000	6000	
Blister	90665	906652	M4x8 mm	ZN	20	-	10	
	90744	907444	M4x10 mm	ZN	20	-	10	
	90666	906669	M4x14 mm	ZN	20	-	10	
	90667	906676	M4x20 mm	ZN	20	-	10	
	90668	906683	M4x22 mm	ZN	16	-	10	
	90669	906690	M4x25 mm	ZN	16	-	10	
	90670	906706	M4x28 mm	ZN	16	-	10	
	90671	906713	M4x30 mm	ZN	16	-	10	
	90673	906737	M4x35 mm	ZN	12	-	10	
90674	906744	M4x40 mm	ZN	12	-	10		

Acero

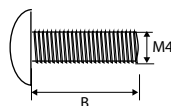



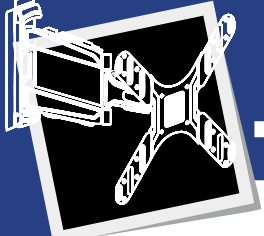

JGO BISAGRA ELEVABLE P/MESAS CENTRO BS26

Código	8431488	Medida	Acabado				€uros
	95038	950389	380x40x22 mm	NE	-	1	15
	95039	950396	380x40x22 mm	GR	-	1	15
	95040	950402	410x40x22 mm	NE	-	1	15

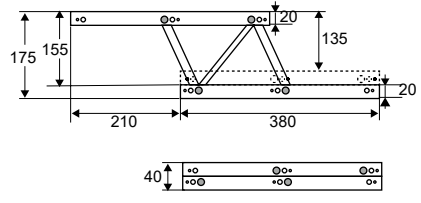
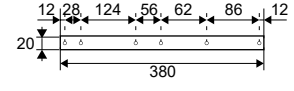
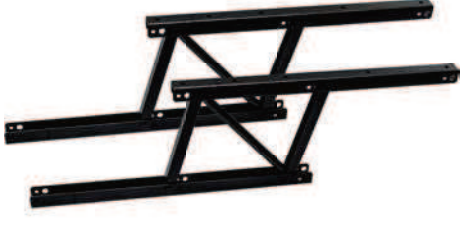

95038 - 95039

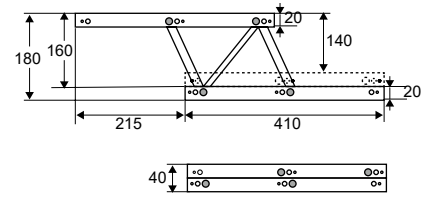
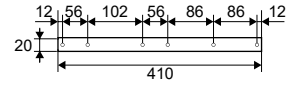

95040

Acero



JGO GUÍA CAJÓN GC12

Código	8431488	Medida A	Acabado				€uros
Caja	75000	750002	250 mm	MA	-	40	-
	75001	750019	330 mm	MA	-	40	-

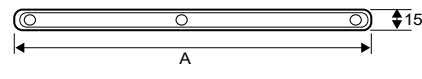

Poliestireno



SISTEMA AMORTIGUADOR GUÍA GC15

Código	8431488	Medida	Acabado				€uros
Caja	10919	109190	224 mm	GR	-	10	100

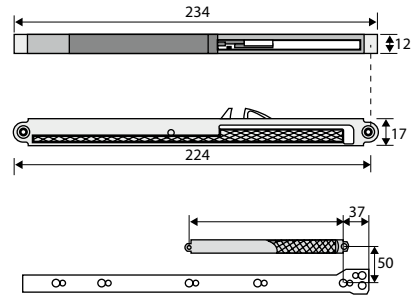

ABS

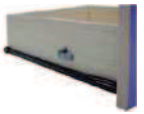

Freno cierre amortiguado. Deslizamiento suave y silencioso. Reversible, no guarda mano. Sirve para cualquier tipo de guía, puertas correderas de armario, etc. Capacidad de carga 25 kgs. Testado en 40.000 cierres.

JGO GUÍA CAJÓN GC1

Código	8431488	Medida A	Acabado				€uros
75025	750255	250 mm	BL	-	20	-	
75030	750309	300 mm	BL	-	20	-	
75035	750354	350 mm	BL	-	20	-	
75040	750408	400 mm	BL	-	20	-	
75045	750453	450 mm	BL	-	20	-	
75050	750507	500 mm	BL	-	20	-	
75055	750552	550 mm	BL	-	20	-	
75060	750606	600 mm	BL	-	20	-	
75080	750804	800 mm	BL	-	1	20	
76025	760254	250 mm	MA	-	20	-	
76030	760308	300 mm	MA	-	20	-	
76035	760353	350 mm	MA	-	20	-	
76040	760407	400 mm	MA	-	20	-	
76045	760452	450 mm	MA	-	20	-	
76050	760506	500 mm	MA	-	20	-	
76055	760551	550 mm	MA	-	20	-	
76060	760605	600 mm	MA	-	20	-	
76080	760803	800 mm	MA	-	1	20	
75002	750026	250 mm	AL	-	20	-	
75003	750033	300 mm	AL	-	20	-	
75004	750040	350 mm	AL	-	20	-	
75005	750057	400 mm	AL	-	20	-	
75006	750064	450 mm	AL	-	20	-	
75007	750071	500 mm	AL	-	20	-	
75008	750088	550 mm	AL	-	20	-	
75009	750095	600 mm	AL	-	20	-	



Acero

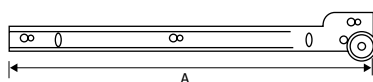

ENGANCHE FRONTAL REG P/CAJÓN METÁLICO ENG1

Código	8431488	Medida	Acabado				€uros
Caja	75010	750101	74x14 mm	NI	-	12	120

Zamak

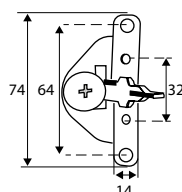
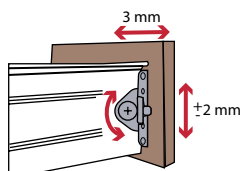

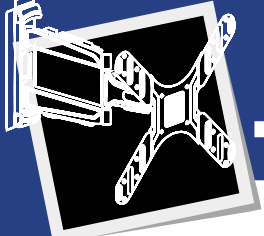

JGO MICROGUÍA 17 MM GC2



	Código	8431488	Medida	Acabado				€uros
Caja	77182	771823	17x182 mm	ZN	-	25	-	
	77214	772141	17x214 mm	ZN	-	25	-	
	77246	772462	17x246 mm	ZN	-	25	-	
	77278	772783	17x278 mm	ZN	-	25	-	
	77310	773100	17x310 mm	ZN	-	25	-	
	77342	773421	17x342 mm	ZN	-	25	-	
	77374	773742	17x374 mm	ZN	-	25	-	
	77406	774060	17x406 mm	ZN	-	25	-	
	77438	774381	17x438 mm	ZN	-	25	-	
	77470	774701	17x470 mm	ZN	-	25	-	
77502	775029	17x502 mm	ZN	-	25	-		



Carga máxima por juego 8 Kgs

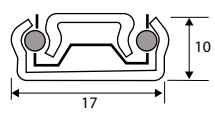

Acero



ZINCADO

JGO MICROGUÍA 27 MM GC3



	Código	8431488	Medida	Acabado				€uros
Caja	79182	791821	27x182 mm	ZN	-	25	-	
	79214	792149	27x214 mm	ZN	-	25	-	
	79246	792460	27x246 mm	ZN	-	25	-	
	79278	792781	27x278 mm	ZN	-	25	-	
	79310	793108	27x310 mm	ZN	-	25	-	
	79342	793429	27x342 mm	ZN	-	25	-	
	79374	793740	27x374 mm	ZN	-	25	-	
	79406	794068	27x406 mm	ZN	-	25	-	
	79438	794389	27x438 mm	ZN	-	25	-	
	79470	794709	27x470 mm	ZN	-	25	-	
79502	795027	27x502 mm	ZN	-	25	-		

Carga máxima por juego 15 Kgs

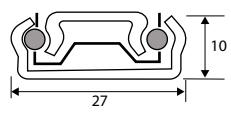

Acero



ZINCADO



Te sugiero:

TORNILLO EURO

Pág. 277



30834

TORNILLO MICROGUÍA

Pág. 210



30410

30480

JGO GUÍA CAJÓN TELESCÓPICA 36 MM GC4

Código	843 1488	Medida	Acabado				€uros
73030	730301	36x300 mm	ZN	-	1	15	
73035	730356	36x350 mm	ZN	-	1	15	
73040	730400	36x400 mm	ZN	-	1	15	
73045	730455	36x450 mm	ZN	-	1	15	
73050	730509	36x500 mm	ZN	-	1	15	

Acero



ZINCADO

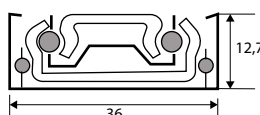

Gatillo de desmontaje



Montaje del cajón mediante tornillos.

Carga máxima por juego 35 Kgs.

Sistema de freno mediante amortiguador especial de goma.

Extracción total.

Dispone de gatillo lateral para desmontaje.

Incluye código de barras individual.

JGO GUÍA CAJÓN TELESCÓPICA 45 MM GC5

Código	843 1488	Medida	Acabado				€uros
78025	780252	45x250 mm	ZN	-	1	15	
78030	780306	45x300 mm	ZN	-	1	15	
78035	780351	45x350 mm	ZN	-	1	15	
78040	780405	45x400 mm	ZN	-	1	15	
78045	780450	45x450 mm	ZN	-	1	15	
78050	780504	45x500 mm	ZN	-	1	15	
78055	780559	45x550 mm	ZN	-	1	15	
78060	780603	45x600 mm	ZN	-	1	15	
78070	780702	45x700 mm	ZN	-	1	15	
78080	780801	45x800 mm	ZN	-	1	15	
78090	780900	45x900 mm	ZN	-	1	15	
78100	781006	45x1000 mm	ZN	-	1	15	

Acero



ZINCADO

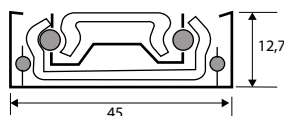

Gatillo de desmontaje

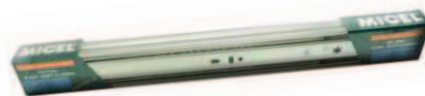

Montaje del cajón mediante tornillos. Carga máxima por juego 45 Kgs.

Para las guías de más de 600 mm de longitud las cargas se reducen un 20% sobre la carga máxima indicada.

Sistema de freno mediante amortiguador especial de goma.

Extracción total.

Dispone de gatillo lateral para desmontaje.

Incluye código de barras individual.

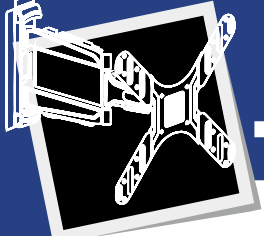

JGO GUÍA TELESCÓPICA SOFT 45 MM GC7

Código	8431488	Medida	Acabado				€uros
72999	729992	45x300 mm	ZN	-	1	15	
73000	730004	45x350 mm	ZN	-	1	15	
73001	730011	45x400 mm	ZN	-	1	15	
73002	730028	45x450 mm	ZN	-	1	15	
73003	730035	45x500 mm	ZN	-	1	15	
73004	730042	45x550 mm	ZN	-	1	15	
73013	730134	45x600 mm	ZN	-	1	15	

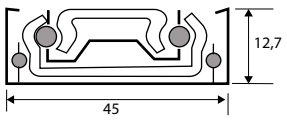
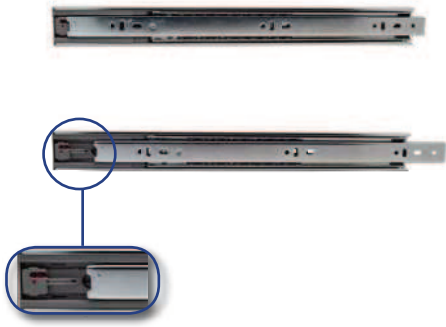

Sistema soft-close

Acero
ZINCADO



Gatillo de desmontaje

Carga máxima por juego 45 Kgs.
Sistema de amortiguación silencioso y suave.
Extracción total.
Dispone de gatillo lateral para desmontaje.
Incluye código de barras individual.



JGO GUÍA TELESCÓPICA PUSH 45 MM GC8

Código	8431488	Medida	Acabado				€uros
73012	730127	45x300 mm	ZN	-	1	15	
73005	730059	45x350 mm	ZN	-	1	15	
73006	730066	45x400 mm	ZN	-	1	15	
73007	730073	45x450 mm	ZN	-	1	15	
73008	730080	45x500 mm	ZN	-	1	15	
73009	730097	45x550 mm	ZN	-	1	15	

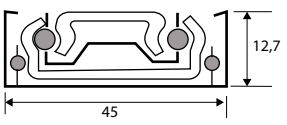
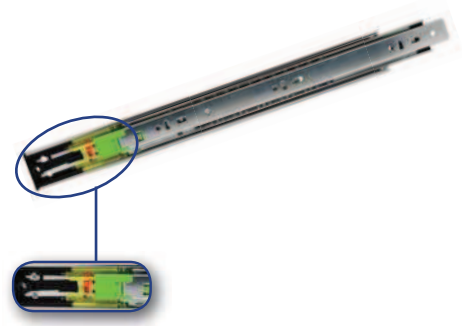

Sistema push-open

Acero
ZINCADO



Gatillo de desmontaje

Carga máxima por juego 45 Kgs.
Sistema de apertura de expulsión (no hace falta tiradores).
Extracción total.
Dispone de gatillo lateral para desmontaje.
Incluye código de barras individual.

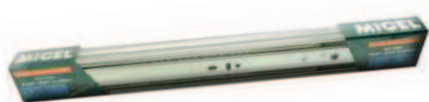

JGO GUÍA TELESCÓPICA 45 MM SOFT-PUSH GC11

Código	8431488	Medida	Acabado				€uros
73028	730288	45x300 mm	ZN	-	1	15	
73029	730295	45x350 mm	ZN	-	1	15	
73023	730233	45x400 mm	ZN	-	1	15	
73024	730240	45x450 mm	ZN	-	1	15	
73025	730257	45x500 mm	ZN	-	1	15	
73026	730264	45x550 mm	ZN	-	1	15	
73027	730271	45x600 mm	ZN	-	1	15	

Acero



ZINCADO

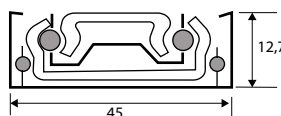

Todo en 1:

✓ **Amortiguación Soft-Close:**

de cierre suave y silencioso.

✓ **Sistema Push-Open**

para apertura sin tirador mediante una sencilla pulsación desde el frontal



Gatillo de desmontaje

Carga máxima por juego 45 Kgs.
 Sistema de apertura de expulsión (no hace falta tiradores).
 Sistema de amortiguación silencioso y suave.
 Dispone de gatillo lateral para desmontaje.
 Montaje en cajón mediante tornillo.
 Extracción total.
 Incluye código de barras individual.



JGO GUÍA CAJÓN TELESCÓPICA 53 MM GC6

Código	8431488	Medida	Acabado				€uros
78130	781303	53x300 mm	ZN	-	1	5	
78140	781402	53x400 mm	ZN	-	1	5	
78150	781501	53x500 mm	ZN	-	1	5	
78160	781600	53x600 mm	ZN	-	1	5	
78170	781709	53x700 mm	ZN	-	1	5	
78180	781808	53x800 mm	ZN	-	1	5	
78190	781907	53x900 mm	ZN	-	1	5	
78110	781105	53x1050 mm	ZN	-	1	5	

Acero



ZINCADO

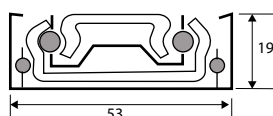

Gatillo de desmontaje

Posibilidad de montaje lateral o en plano.
 Capacidad máxima de carga 100 kgs, excepto cuando se monta plana que son 35 kgs.
 Extracción total.
 Dispone de gatillo lateral para desmontaje.

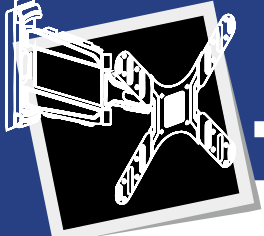

JGO GUÍA CAJÓN CUADRO SOFT GC9

	Código	8431488	Extracción	Medida	Acabado				€uros
Caja	70530	705309	parcial	300 mm	ZN	-	1	10	
	70535	705354	parcial	350 mm	ZN	-	1	10	
	70540	705408	parcial	400 mm	ZN	-	1	10	
	70545	705453	parcial	450 mm	ZN	-	1	10	
	70550	705507	parcial	500 mm	ZN	-	1	10	
	70630	706306	total	300 mm	ZN	-	1	10	
	70635	706351	total	350 mm	ZN	-	1	10	
	70640	706405	total	400 mm	ZN	-	1	10	
	70645	706450	total	450 mm	ZN	-	1	10	
	70650	706504	total	500 mm	ZN	-	1	10	



Guía invisible con óptima estabilidad.
Carga máxima por juego 30 Kgs.
Movimiento silencioso y suave.
Salida paralela del cajón.
Regulación vertical del cajón + 3 mm.
Fijación del cajón sin tornillos.

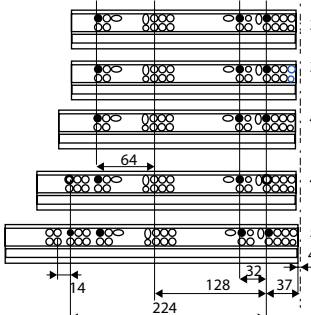

Sistema soft-close

Acero

ZINCADO

JGO GUÍA CAJÓN CUADRO PUSH GC10

	Código	8431488	Extracción	Medida	Acabado				€uros
Caja	70735	707358	parcial	350 mm	ZN	-	1	10	
	70740	707402	parcial	400 mm	ZN	-	1	10	
	70745	707457	parcial	450 mm	ZN	-	1	10	
	70750	707501	parcial	500 mm	ZN	-	1	10	
	70830	708300	total	300 mm	ZN	-	1	10	
	70835	708355	total	350 mm	ZN	-	1	10	
	70840	708409	total	400 mm	ZN	-	1	10	
	70845	708454	total	450 mm	ZN	-	1	10	
	70850	708508	total	500 mm	ZN	-	1	10	



Mecanismo de expulsión

Guía invisible con óptima estabilidad.
Carga máxima por juego 30 Kgs.
Sistema apertura de expulsión, no hace falta tirador.
Salida paralela del cajón.
Regulación vertical del cajón + 3 mm.
Fijación del cajón sin tornillos.

Sistema push-open

Acero

ZINCADO

CAJÓN LATERAL SOFT 80 MM GC13

	Código	8431488	Medida	Acabado				€uros
Caja	70500	705002	80x270 mm	GR	-	1	6	
	70501	705019	80x300 mm	GR	-	1	6	
	70502	705026	80x350 mm	GR	-	1	6	
	70503	705033	80x400 mm	GR	-	1	6	
	70504	705040	80x450 mm	GR	-	1	6	
	70505	705057	80x500 mm	GR	-	1	6	



Carga máxima por juego 25 Kgs.
Sistema de amortiguación silencioso y suave.
Presentación en caja individual.

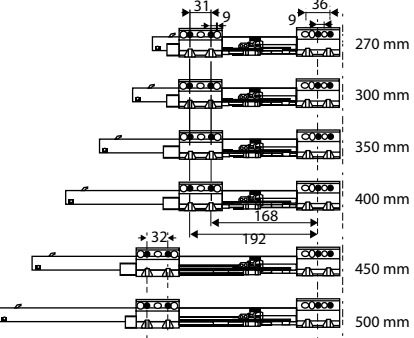

Sistema soft-close

Acero

GRIS

JGO GUÍA PORTATECLADO GC14

Código	8431488	Medida	Acabado				€uros
	95003	950037	350 mm	ZN	-	1	10

Acero



ZINCADO

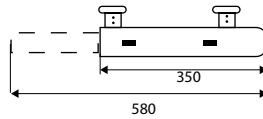

SOPORTE TECLADO STO1

Código	8431488	Tipo	Acabado				€uros
Caja	95001	950013	sin bandeja	BL	-	1	10
	95002	950020	con bandeja	BL	-	1	10

PVC



BLANCO

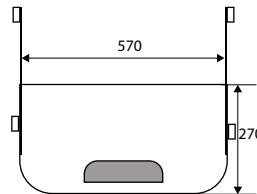

TAPÓN PASACABLESTPC1

Código	8431488	Medida AxB	Acabado				€uros
Caja	95004	950044	60x22 mm	GR	-	20	500
	95005	950051	60x22 mm	NE	-	20	500
	95008	950082	60x22 mm	BE	-	20	500
	95009	950099	60x22 mm	MA	-	20	500
	95010	950105	60x22 mm	PL	-	20	500
	95011	950112	60x22 mm	BL	-	20	500
	95014	950143	80x22 mm	GR	-	20	100
	95015	950150	80x22 mm	NE	-	20	100
	95018	950181	80x22 mm	BL	-	20	100
Blister	90232	902326	60x22 mm	GR	1	-	10
	90234	902340	60x22 mm	NE	1	-	10
	90618	906188	60x22 mm	BE	1	-	10
	90619	906195	60x22 mm	MA	1	-	10
	90620	906201	60x22 mm	PL	1	-	10
	90621	906218	60x22 mm	BL	1	-	10
	90233	902333	80x22 mm	GR	1	-	10
	90235	902357	80x22 mm	NE	1	-	10
	92322	923222	80x22 mm	BL	1	-	10

ABS



GRIS NEGRO BEIGE MARRÓN PLATA BLANCO

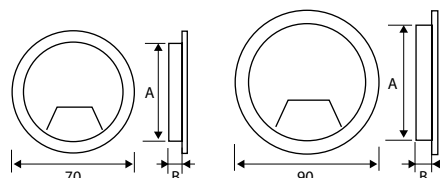

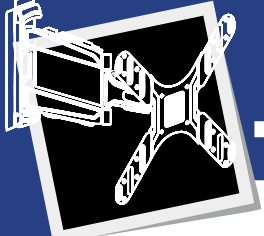

SOPORTE TV LCD 17"- 37" STV1

	Código	8431488	Medida	Acabado				€uros
Caja	31277	312774	17"- 37"	NE	-	1	10	



Acero
●
NEGRO

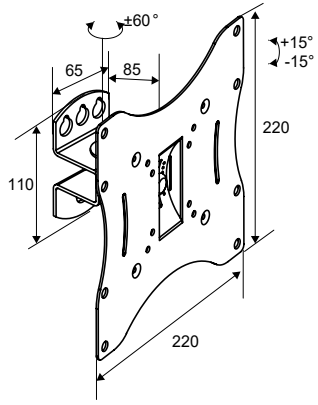

SOPORTE TV LCD 17"- 37" STV2

	Código	8431488	Medida	Acabado				€uros
Caja	31278	312781	17"- 37"	NE	-	1	10	



Acero
●
NEGRO

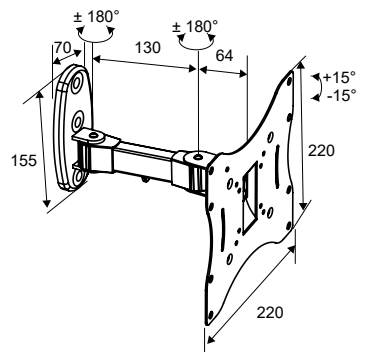

SOPORTE TV LCD 17"- 37" STV3

	Código	8431488	Medida	Acabado				€uros
Caja	31279	312798	17"- 37"	NE	-	1	6	



Acero
●
NEGRO

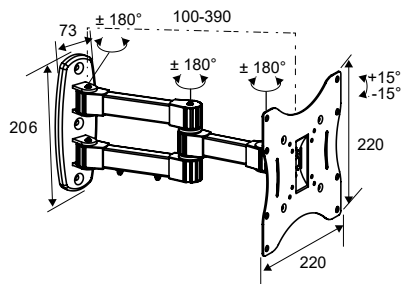

SOPORTE TV LCD 17" - 47" STV4

	Código	8431488	Medida	Acabado				€uros
Caja	31280	312804	17"- 47"	NE	-	1	8	

Acero



NEGRO

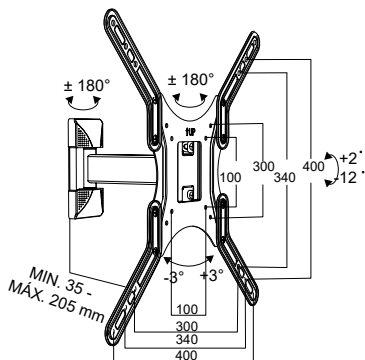

SOPORTE TV LCD 17" - 55" STV5

	Código	8431488	Medida	Acabado				€uros
Caja	31281	312811	17"- 55"	NE	-	1	4	

Acero



NEGRO

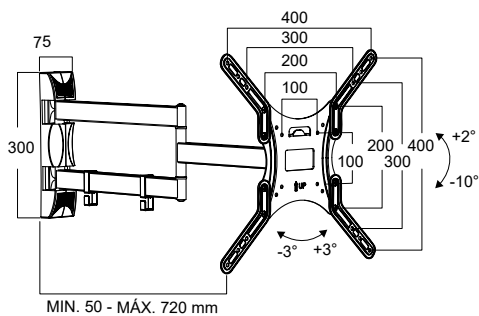

SOPORTE TV LCD 30" - 70" STV9

	Código	8431488	Medida	Acabado				€uros
Caja	31285	312859	30"- 70"	NE	-	1	10	

Acero



NEGRO

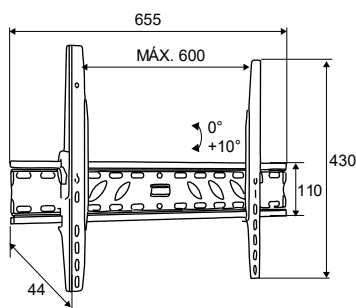

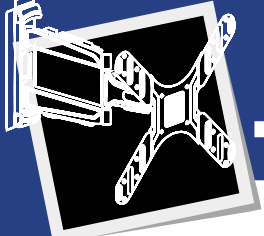

SOPORTE TV LCD 30"- 63" STV6

	Código	8431488	Medida	Acabado				€uros
Caja	31282	312828	30"- 63"	NE	-	1	4	



Acero
●
NEGRO

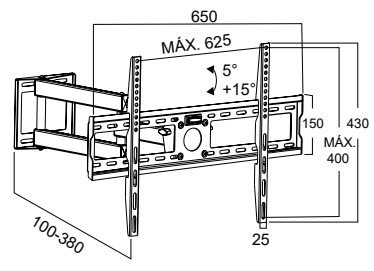

SOPORTE TV LCD 30"- 70" STV7

	Código	8431488	Medida	Acabado				€uros
Caja	31283	312835	30"- 70"	NE	-	1	4	



Acero
●
NEGRO

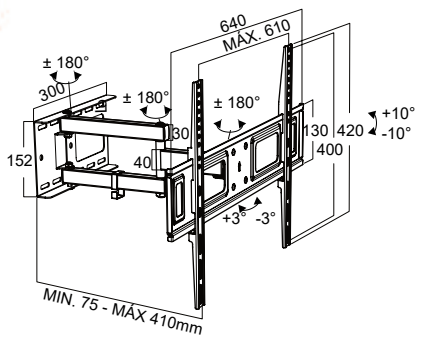

SOPORTE TV LCD 30"- 63" STV8

	Código	8431488	Medida	Acabado				€uros
Caja	31284	312842	30"- 63"	NE	-	1	2	



Acero
●
NEGRO

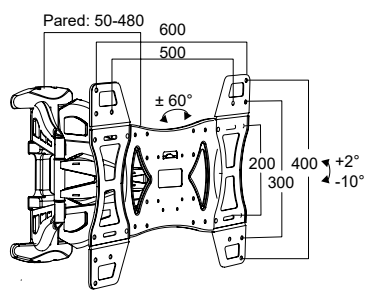





PANTALONERO EXTRACCIÓN TOTAL IA1

	Código	8431488	Tipo	Acabado				€uros
Caja	94001	940014	8 perchas	CB	-	1	5	
	94002	940021	10 perchas	CB	-	1	5	

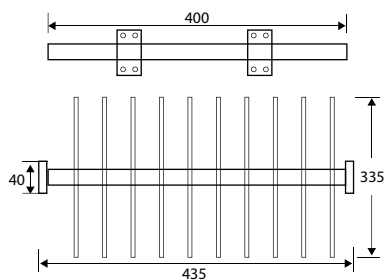
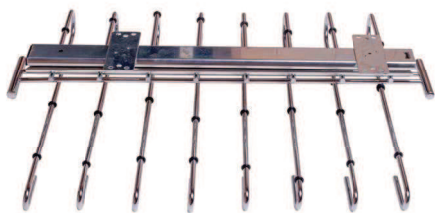

Acero

CROMO BRILLO

PANTALONERO EXTRACCIÓN TOTAL IA2

	Código	8431488	Tipo	Acabado				€uros
Caja	94003	940038	11 perchas	CB	-	1	5	

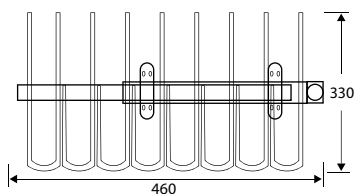

Acero

CROMO BRILLO



Antideslizante
Tope: Goma
Tirador: Zamak



ZAPATERO LATERAL EXTRACCIÓN TOTAL IA3

	Código	8431488	Medida	Acabado				€uros
Caja	94014	940144	400/600x120x450 mm	CB	-	1	2	
	94015	940151	600/1000x120x450 mm	CB	-	1	2	

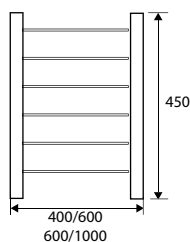
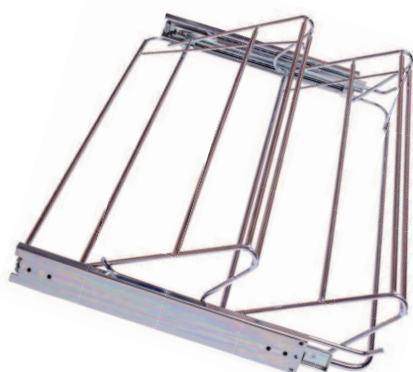

Acero

CROMO BRILLO

ZAPATERO FRONTAL CAJÓN EXTRAÍBLE IA4

	Código	8431488	Medida	Acabado				€uros
Caja	94012	940120	400/600x120x400 mm	CB	-	1	2	
	94013	940137	600/1000x120x450 mm	CB	-	1	2	

Acero

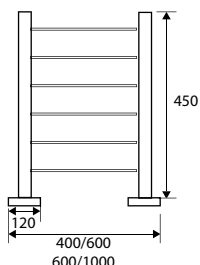

JGO ZAPATERO IA6

	Código	8431488	Tipo	Acabado				€uros
	94025	940250	2 baldas	BL	-	1	6	
	94026	940267	2 baldas	MA	-	1	6	

Poliestireno

Retractable individual

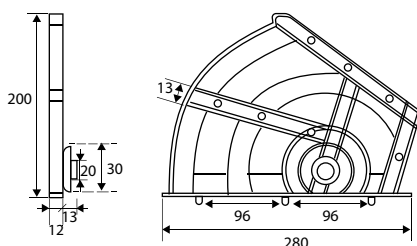

CORBATERO VARILLA IA8

	Código	8431488	Medida A	Acabado				€uros
Blister	10079	100791	250 mm	OR	1	-	10	
	10080	100807	300 mm	OR	1	-	10	
	10081	100814	350 mm	OR	1	-	10	
	10082	100821	400 mm	OR	1	-	10	
	10083	100838	450 mm	OR	1	-	10	
	10084	100845	500 mm	OR	1	-	10	
	10792	107929	250 mm	NI	1	-	10	
	10802	108025	300 mm	NI	1	-	10	
	10812	108124	350 mm	NI	1	-	10	
	10822	108223	400 mm	NI	1	-	10	
	10832	108322	450 mm	NI	1	-	10	
	10842	108421	500 mm	NI	1	-	10	

Acero

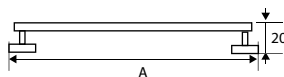
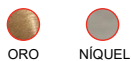



SOPORTE PERCHAS EXTRAÍBLE IA7



Código	8431488	Medida A	Acabado				€uros
94018	940182	300 mm	CB	-	1	20	
94019	940199	350 mm	CB	-	1	20	
94020	940205	400 mm	CB	-	1	20	
94021	940212	450 mm	CB	-	1	20	
94023	940236	500 mm	CB	-	1	20	

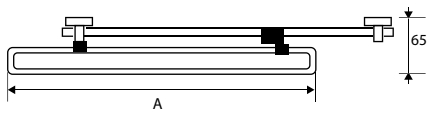

Acero
 CROMO BRILLO



PERCHERO ABATIBLE IA5

Código	8431488	Medida A	Acabado				€uros
94009	940090	450/600 mm	AL	-	1	6	
94010	940106	600/830 mm	AL	-	1	6	
94011	940113	830/1150 mm	AL	-	1	6	

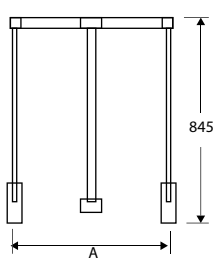

Aluminio
 ALUMINIO

ESPIRAL DE VISILLO FORRADO EV1

Código	8431488	Medida	Acabado				€uros
73328	733289	50 mts	BL	-	1	10	
91801	918013	2 mts	BL	1	-	10	
91228	912288	3 mts	BL	1	-	10	



91228 - 4 hembrillas abiertas y 4 hembrillas cerradas

91801 - 2 hembrillas abiertas y 2 hembrillas cerradas

Acero
 BLANCO

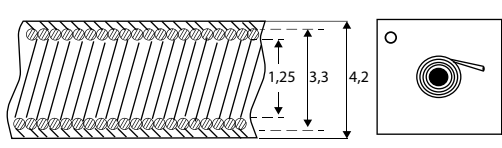

TERMINAL ESPIRAL VISILLO EV2

	Código	8431488	Medida	Acabado			€uros
Caja	73335	733357	8x5 mm	NI	-	50	200

Latón

No incluye hembra

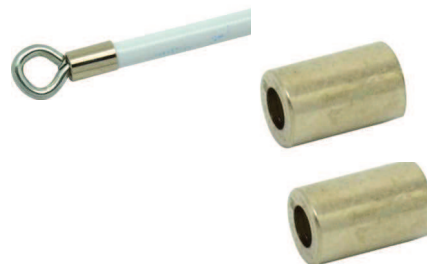

KIT TERMINAL ESPIRAL VISILLO EV3

	Código	8431488	Medida	Acabado			€uros
Caja	91379	913797	-	NI	-	50	500
Blister	91380	913803	-	NI	1	-	10

Acero/Latón

Contiene 2 Hembra abiertas, 2 Hembra cerradas y 2 terminales

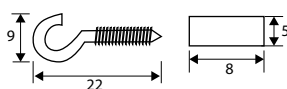

LED C/SENSOR MULTIUSO LD2

	Código	8431488	Medida	Acabado			€uros
Caja	92002	920023	65x60 mm	BL	-	1	20
Blister	92426	924267	65x60 mm	BL	1	-	10

Polipropileno

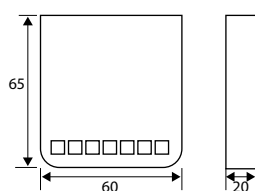

Lámpara de inducción.
Fácil instalación
Muy útil, ilumina al abrirse: cajones, despensas, armarios, muebles de cocina, etc.
Funciona a pilas (incluidas)

TUBO ARMARIO C/LED LD1

	Código	8431488	Medida	Acabado			€uros
Caja	92001	920016	30x15 mm x 1 mt	PL	-	1	5

Aluminio

Con sensor
0,6 W
9v. DC



Activación mediante sensor de movimiento a una distancia de 1,5 - 2 mts, y se apaga transcurridos 20 segundos. Funcionamiento a pilas, con fácil sustitución. Último tramo con corte para su perfecta adaptación. Incorpora una goma para evitar arañazos de las perchas.

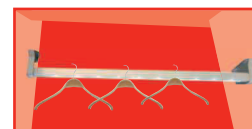



TUBO ARMARIO TA1



	Código	8431488	Medida AxB	Acabado			€uros
Caja	12100	121000	ø12 mm x 1 mt	CB	-	25	-
	12150	121505	ø12 mm x 1,5 mts	CB	-	25	-
	12200	122007	ø12 mm x 2 mts	CB	-	25	-
	12250	122502	ø12 mm x 2,5 mts	CB	-	25	-
	12300	123004	ø12 mm x 3 mts	CB	-	25	-
	12400	124001	ø12 mm x 4 mts	CB	-	25	-
	12401	124018	ø12 mm x 4 mts	BL	-	25	-
	16100	161006	ø16 mm x 1 mt	CB	-	25	-
	16150	161501	ø16 mm x 1,5 mts	CB	-	25	-
	16200	162003	ø16 mm x 2 mts	CB	-	25	-
	16250	162508	ø16 mm x 2,5 mts	CB	-	25	-
	16300	163000	ø16 mm x 3 mts	CB	-	25	-
	16400	164007	ø16 mm x 4 mts	CB	-	25	-
	16401	164014	ø16 mm x 4 mts	BL	-	25	-
	19100	191003	ø19 mm x 1 mt	CB	-	20	-
	19150	191508	ø19 mm x 1,5 mts	CB	-	20	-
	19200	192000	ø19 mm x 2 mts	CB	-	20	-
	19250	192505	ø19 mm x 2,5 mts	CB	-	20	-
	19300	193007	ø19 mm x 3 mts	CB	-	20	-
	19400	194004	ø19 mm x 4 mts	CB	-	20	-
	20400	204000	ø25 mm x 4 mts	CB	-	10	-

Precio por tubo
Espesor 0,8 mm

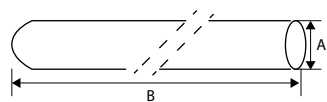

Acero
 CROMO BRILLO
 BLANCO



EMPALME TUBO TA5

	Código	8431488	Medida	Acabado			€uros
Caja	73327	733272	ø12 mm	ZN	-	25	250
Blister	91230	912301	ø12 mm	ZN	2	-	10

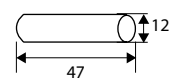

Acero
 ZINCADO

TUBO ARMARIO OVAL TA2



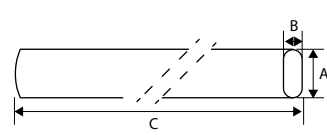

	Código	8431488	Medida AxBxC	Acabado			€uros
Caja	25200	252001	25x15 mm x 2 mts	CB	-	20	-
	25400	254005	25x15 mm x 4 mts	CB	-	20	-
	25403	254036	30x15 mm x 4 mts	CB	-	15	-
	25201	252018	25x15 mm x 2 mts	LTD	-	20	-
	25401	254012	25x15 mm x 4 mts	LTD	-	20	-
	25402	254029	25x15 mm x 4 mts	BL	-	20	-

Precio por tubo
Espesor 0,8 mm



Acero
 CROMO BRILLO
 LATONADO
 BLANCO

TUBO ARMARIO RETRACTILADO TA3

Código	8431488	Medida AxB	Acabado				€uros
30404	304045	ø19 mm x 1 mts	CB	-	20	-	
30395	303956	ø19 mm x 1,5 mts	CB	-	20	-	
30405	304052	ø19 mm x 2 mts	CB	-	20	-	
30406	304069	25x15 mm x 1 mts	CB	-	20	-	
30394	303949	25x15 mm x 1,5 mts	CB	-	20	-	
30407	304076	25x15 mm x 2 mts	CB	-	20	-	
30396	303963	25x15 mm x 2,5 mts	CB	-	20	-	
30408	304083	25x15 mm x 1 mts	LTD	-	20	-	
30386	303864	25x15 mm x 1,5 mts	LTD	-	20	-	
30409	304090	25x15 mm x 2 mts	LTD	-	20	-	
30390	303901	30x15 mm x 1 mts	CB	-	15	-	
30391	303918	30x15 mm x 2 mts	CB	-	15	-	

Acero



Precio por tubo
Espesor 0,8 mm
Retractilado individualmente

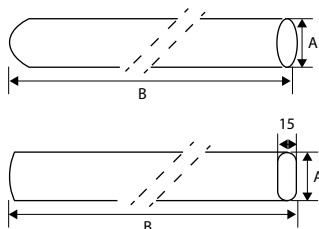

TUBO ARMARIO OVAL TA4

Código	8431488	Medida AxBxC	Acabado				€uros
30387	303871	30x15 mm x 2 mts	PL	-	10	-	
30400	304007	30x15 mm x 4 mts	PL	-	10	-	
30388	303888	30x15 mm x 2 mts	OR	-	10	-	
30401	304014	30x15 mm x 4 mts	OR	-	10	-	



Aluminio



Precio por tubo
Espesor 1,2 mm



TUBO ARMARIO ESQUINERO OVAL TA6

Código	8431488	Medida AxB	Acabado				€uros
30384	303840	30x1 mt	PL	-	10	-	
30385	303857	30x1 mt	OR	-	10	-	

Aluminio

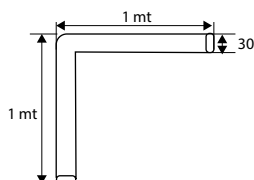



SOPORTE LATERAL REDONDO STA1

	Código	8431488	Medida A	Acabado				€uros
Caja	70121	701219	12 mm	NI	-	100	1000	
	70161	701615	16 mm	NI	-	100	1000	
	70191	701912	19 mm	NI	-	100	500	
Blister	90238	902388	12 mm	NI	2	-	10	
	90237	902371	16 mm	NI	2	-	10	
	90236	902364	19 mm	NI	2	-	10	

Incluye tornillos en el blister

Latón

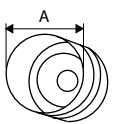

NIQUEL

SOPORTE CENTRAL REDONDO STA2

	Código	8431488	Medida A	Acabado				€uros
Caja	71121	711218	12 mm	NI	-	50	250	
	71161	711614	16 mm	NI	-	50	250	
	71191	711911	19 mm	NI	-	50	250	
Blister	90254	902548	12 mm	NI	2	-	10	
	90255	902555	16 mm	NI	2	-	10	
	90256	902562	19 mm	NI	2	-	10	

Incluye tornillos en el blister

Zamak

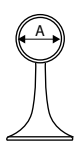

NIQUEL



SOPORTE LATERAL STA1 + CENTRAL STA2

	Código	8431488	Medida A	Acabado				€uros
Blister	90241	902418	12 mm	NI	2+1	-	10	
	90240	902401	16 mm	NI	2+1	-	10	
	90239	902395	19 mm	NI	2+1	-	10	

Incluye tornillos en el blister

Latón/Zamak

Contiene 2 casquillos y 1 soporte central

NIQUEL



SOPORTE CERRADO REDONDO STA3

	Código	8431488	Medida A	Acabado				€uros
Caja	72121	721217	12 mm	NI	-	50	250	
	72161	721613	16 mm	NI	-	50	250	
	72191	721910	19 mm	NI	-	50	250	
Blister	90257	902579	12 mm	NI	2	-	10	
	90258	902586	16 mm	NI	2	-	10	
	90259	902593	19 mm	NI	2	-	10	

Incluye tornillos en el blister

Zamak

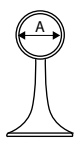

NIQUEL



SOPORTE LATERAL REDONDO STA4

	Código	8431488	Medida A	Acabado				€uros
Caja	70251	702513	25 mm	CB	-	50	500	

Acero

CROMO BRILLO

Incluye tornillos en el blíster

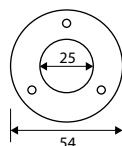

SOPORTE CENTRAL REGULABLE STA5

	Código	8431488	Medida	Acabado				€uros
Caja	71251	712512	25 mm	NI	-	50	250	

Zamak

NÍQUEL

Incluye tornillos en el blíster
Regulación de 80 a 100 mm

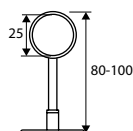

SOPORTE LATERAL STOR STA14

	Código	8431488	Medida	Acabado				€uros
Caja	75255	752556	14 mm	BC	-	100	1000	
	75256	752563	18 mm	BC	-	100	1000	
	75257	752570	22 mm	BC	-	100	1000	
Blister	91231	912318	14 mm	BC	2	-	10	
	91232	912325	18 mm	BC	2	-	10	
	91233	912332	22 mm	BC	2	-	10	

Acero

BICROMATADO

Incluye tornillos en el blíster

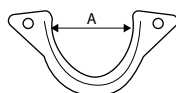

SOPORTE LATERAL OVAL STA15

	Código	8431488	Medida	Acabado				€uros
Caja	60801	608013	17 mm	BL	-	100	2000	
	60802	608020	17 mm	MA	-	100	2000	
Blister	90247	902470	17 mm	BL	2	-	10	
	90248	902487	17 mm	MA	2	-	10	

Polietileno

BLANCO MARRÓN

Incluye tornillos en el blíster

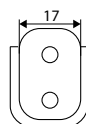



SOPORTE LATERAL OVAL STA6

	Código	8431488	Medida	Acabado				€uros
Caja	75251	752518	15 mm	NI	-	100	1000	
	75252	752525	15 mm	LTD	-	100	1000	
	75253	752532	15 mm	AL	-	100	1000	
	75254	752549	15 mm	BL	-	100	1000	
Blister	90242	902425	15 mm	NI	2	-	10	
	90243	902432	15 mm	LTD	2	-	10	
	90244	902449	15 mm	AL	2	-	10	
	91229	912295	15 mm	BL	2	-	10	

Incluye tornillos en el blister

Zamak

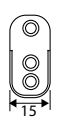

SOPORTE CENTRAL OVAL STA7

	Código	8431488	Medida Ax B	Acabado				€uros
Caja	73251	732510	25x15 mm	NI	-	50	250	
	73252	732527	25x15 mm	LTD	-	50	250	
Blister	90260	902609	25x15 mm	NI	2	-	10	
	90261	902616	25x15 mm	LTD	2	-	10	

Incluye tornillos en el blister

Zamak

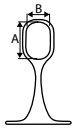

SOPORTE CENTRAL OVAL STA8

	Código	8431488	Medida Ax B	Acabado				€uros
Caja	73301	733012	30x15 mm	NI	-	50	500	
	73302	733029	30x15 mm	LTD	-	50	500	
	73303	733036	30x15 mm	AL	-	50	500	
Blister	90262	902623	30x15 mm	NI	2	-	10	
	90263	902630	30x15 mm	LTD	2	-	10	
	90264	902647	30x15 mm	AL	2	-	10	

Incluye tornillos en el blister

Zamak

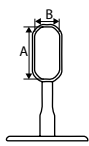

SOPORTE LATERAL STA6 + CENTRAL OVAL STA7/8

	Código	8431488	Medida interior	Acabado				€uros
Blister	90249	902494	25x15 mm	NI	2+1	-	10	
	90250	902500	25x15 mm	LTD	2+1	-	10	
	90251	902517	30x15 mm	NI	2+1	-	10	
	90252	902524	30x15 mm	LTD	2+1	-	10	
	90253	902531	30x15 mm	AL	2+1	-	10	

Incluye tornillos en el blister
 Contiene 2 soportes laterales y 1 soporte central

Zamak



SOPORTE CERRADO OVAL STA9

	Código	8431488	Medida AxB	Acabado				€uros
Caja	74251	742519	25x15 mm	NI	-	50	250	
	74301	743011	30x15 mm	NI	-	50	250	
	74303	743035	30x15 mm	AL	-	50	250	
Blister	90265	902654	25x15 mm	NI	2	-	10	
	90266	902661	30x15 mm	NI	2	-	10	
	92233	922331	30x15 mm	AL	2	-	10	

Zamak



Incluye tornillos en el blíster

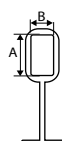

SOPORTE CENTRAL OVAL REGULABLE STA10

	Código	8431488	Medida AxB	Acabado				€uros
Caja	73304	733043	30x15 mm	CB	-	25	125	
	73305	733050	30x15 mm	LTD	-	25	125	
	73306	733067	30x15 mm	AL	-	25	125	
Blister	90269	902692	30x15 mm	CB	2	-	10	
	90270	902708	30x15 mm	LTD	2	-	10	
	90638	906386	30x15 mm	AL	2	-	10	

Zamak



Incluye tornillos en el blíster
Regulación de 90 a 125 mm

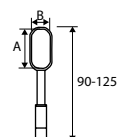

SOPORTE CERRADO OVAL REGULABLE STA11

	Código	8431488	Medida AxB	Acabado				€uros
Caja	74304	743042	30x15 mm	CB	-	25	125	
	74305	743059	30x15 mm	LTD	-	25	125	
	74306	743066	30x15 mm	AL	-	25	125	
Blister	90639	906393	30x15 mm	CB	2	-	10	
	90640	906409	30x15 mm	LTD	2	-	10	
	90641	906416	30x15 mm	AL	2	-	10	

Zamak



Incluye tornillos en el blíster
Regulación de 90 a 125 mm

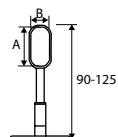



SOPORTE CERRADO TECHO OVAL STA12



	Código	8431488	Medida	Acabado				€uros
Caja	73324	733241	30x15 mm	AL	-	25	125	

No incluye tornillo

Zamak

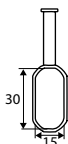

Tornillo Komby disponible en página 281



SOPORTE ESQUINA TECHO OVAL STA13



	Código	8431488	Medida	Acabado				€uros
Caja	73325	733258	30x15 mm	AL	-	25	125	

No incluye tornillo

Zamak

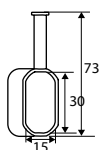

Tornillo Komby disponible en página 281



SOPORTE LATERAL N° 7 STA20



	Código	8431488	Medida	Acabado				€uros
Caja	73307	733074	12 mm	ZN	-	25	500	

Para tubo de 12 mm

Acero

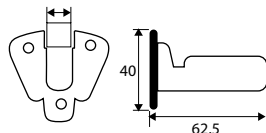

SOPORTE TECHO N° 2 STA17



	Código	8431488	Medida	Acabado				€uros
Caja	73308	733081	12 mm	ZN	-	25	500	
	73316	733166	12 mm	BL	-	25	500	

Para tubo de 12 mm

Acero

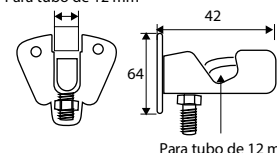

Para tubo de 12 mm

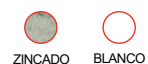

SOPORTE FRENTE N° 1 STA16

	Código	8431488	Medida A	Acabado			€uros
Caja	73309	733098	12 mm	ZN	-	25	250
	73315	733159	12 mm	BL	-	25	250
	73326	733265	16 mm	ZN	-	25	250

Acero

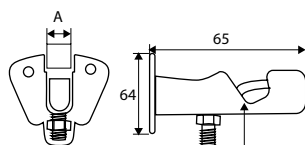

73309: Para tubo de 12 mm
73315: Para tubo de 12 mm
73326: Para tubo de 16 mm



SOPORTE EXTENSIBLE N° 4 STA18

	Código	8431488	Medida	Acabado			€uros
Caja	73310	733104	12 mm	ZN	-	25	250
	73317	733173	12 mm	BL	-	25	250

Acero

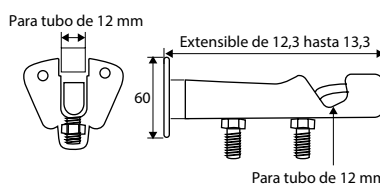

SOPORTE EXTENSIBLE DOBLE N° 5 STA19

	Código	8431488	Medida	Acabado			€uros
Caja	73311	733111	12 mm	ZN	-	25	250

Acero

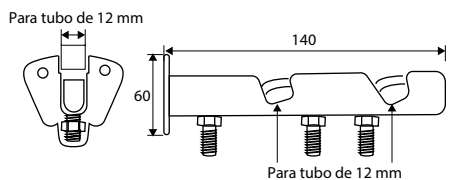

SOPORTE DOBLE TECHO N° 9 STA21

	Código	8431488	Medida	Acabado			€uros
Caja	73312	733128	12 mm	ZN	-	25	250

Acero

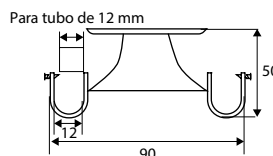

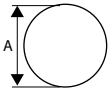
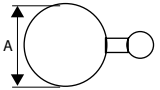
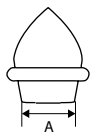
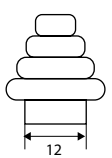

Nylon

REMATE TUBO BELLOTA CT1

	Código	8431488	Medida	Acabado				€uros
Caja	73313	733135	12 mm	CB	-	100	1000	
	73318	733180	12 mm	BL	-	100	1000	
Blister	90849	908496	12 mm	CB	2	-	10	
	91234	912349	12 mm	BL	2	-	10	

CB: ABS - BL: Poliestireno



REMATE TUBO PIÑA CT2

	Código	8431488	Medida A	Acabado				€uros
Caja	73331	733319	12 mm	CB	-	100	1000	
	73332	733326	12 mm	BL	-	100	1000	
	73333	733333	16 mm	CB	-	50	1000	
	73334	733340	16 mm	BL	-	50	1000	
Blister	91238	912387	12 mm	CB	2	-	10	
	91239	912394	12 mm	BL	2	-	10	
	91240	912400	16 mm	CB	2	-	10	
	91241	912417	16 mm	BL	2	-	10	

CB: ABS - BL: Poliestireno

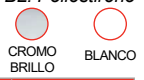

ANILLA TUBO CT3

	Código	8431488	Medida A	Acabado				€uros
Caja	73314	733142	12 mm	CB	-	100	2000	
	73319	733197	12 mm	BL	-	100	2000	
	73329	733296	16 mm	CB	-	50	1000	
	73330	733302	16 mm	BL	-	50	1000	
Blister	90848	908489	12 mm	CB	6	-	10	
	91235	912356	12 mm	BL	6	-	10	
	91237	912370	16 mm	CB	6	-	10	
	91236	912363	16 mm	BL	6	-	10	

CB: ABS - BL: Poliestireno



ANILLA REDONDA CT17

	Código	8431488	Medida A	Acabado				€uros
Caja	73349	733494	8 mm	BL	-	100	-	
	73350	733500	10 mm	BL	-	100	-	
	73351	733517	13 mm	BL	-	100	-	
	73352	733524	16 mm	BL	-	100	-	
	73353	733531	18 mm	BL	-	100	-	
	73354	733548	20 mm	BL	-	100	-	
	73355	733555	22 mm	BL	-	100	-	
	73356	733562	25 mm	BL	-	100	-	
	73357	733579	30 mm	BL	-	100	-	
Blister	92174	921747	8 mm	BL	25	-	10	
	92175	921754	10 mm	BL	25	-	10	
	92176	921761	13 mm	BL	25	-	10	
	92177	921778	16 mm	BL	25	-	10	
	92178	921785	18 mm	BL	25	-	10	
	92179	921792	20 mm	BL	20	-	10	
	92180	921808	22 mm	BL	20	-	10	
92181	921815	25 mm	BL	15	-	10		
92182	921822	30 mm	BL	10	-	10		



BLANCO

GARFIO CORTINA FRENTE CT7

	Código	8431488	Medida	Acabado				€uros
Caja	73336	733364	82x15 mm	ZN	-	100	1000	
Blister	92121	921211	82x15 mm	ZN	6	-	10	

Acero



ZINCADO

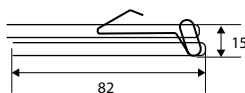

GARFIO CORTINA TECHO CT8

	Código	8431488	Medida	Acabado				€uros
Caja	73337	733371	82x15 mm	ZN	-	100	1000	
Blister	92122	921228	82x15 mm	ZN	6	-	10	

Acero



ZINCADO

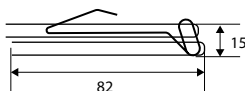

CORCHETE CORTINA CT9

	Código	8431488	Medida	Acabado				€uros
Caja	73338	733388	28,6x11,8 mm	ZN	-	200	5000	
Blister	92123	921235	28,6x11,8 mm	ZN	25	-	10	

Acero



ZINCADO

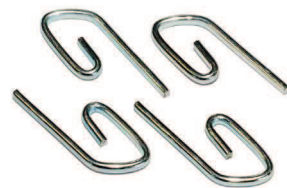
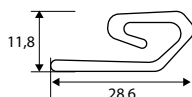

CORCHETE CORTINA CT5

	Código	8431488	Medida	Acabado				€uros
Caja	73322	733227	28,6x11,8 mm	BL	-	200	5000	
Blister	91388	913889	28,6x11,8 mm	BL	25	-	10	

Polietileno



BLANCO

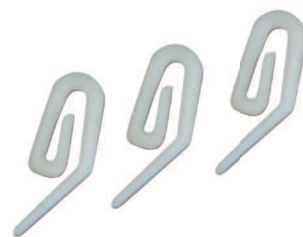
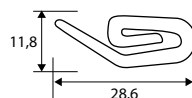

CORCHETE CORTINA COSER CT12

	Código	8431488	Medida	Acabado				€uros
Caja	73339	733395	24,5x16,25 mm	BL	-	200	2000	
Blister	92124	921242	24,5x16,25 mm	BL	25	-	10	

Nylon



BLANCO

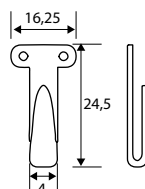



CORCHETE CORTINA COSER CT11



	Código	8431488	Medida	Acabado				€uros
Caja	73340	733401	42,6x14,25 mm	ZN	-	200	5000	
Blister	92125	921259	42,6x14,25 mm	ZN	25	-	10	

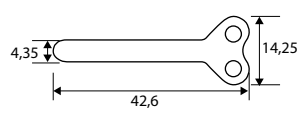

Acero
 ZINCADO

GANCHO CORTINA CT6



	Código	8431488	Medida	Acabado				€uros
Caja	73320	733203	pequeño	ZN	-	200	2000	
	73321	733210	grande	ZN	-	200	2000	

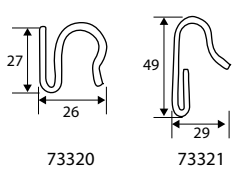

Acero
 ZINCADO

ALFILER VISILLO CT13



	Código	8431488	Medida	Acabado				€uros
Caja	73342	733425	35x19 mm	ZN	-	200	2000	
Blister	92127	921273	35x19 mm	ZN	25	-	10	

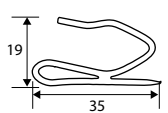

Acero
 ZINCADO

CORCHETE GUÍA RIEL CT10



	Código	8431488	Medida	Acabado				€uros
Caja	73341	733418	11 mm	BL	-	200	2000	
Blister	92126	921266	11 mm	BL	20	-	10	

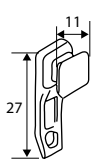

Nylon
 BLANCO

SOPORTE RIEL CT4



	Código	8431488	Medida	Acabado				€uros
	39184	391847	120x70 mm	ZN	-	50	250	

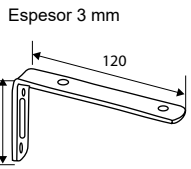

Acero
 ZINCADO

PERFIL CORTINA C/CINTA MACHO CT14

	Código	8431488	Medida	Acabado			€uros
	73343	733432	3 mts	BL	-	5	-
	73344	733449	3 mts	PL	-	5	-

Aluminio

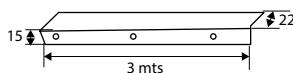
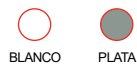

CINTA CIERRE COSER CT15

	Código	8431488	Medida/Tipo	Acabado			€uros
	73345	733456	20x25 mts/macho	BL	-	1	8
	73346	733463	20x25 mts/hembra	BL	-	1	8

Poliamida

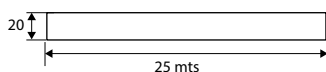

CINTA CIERRE ADHESIVO CT16

	Código	8431488	Medida/Tipo	Acabado			€uros
	73347	733470	20x25 mts/macho	BL	-	1	6
	73348	733487	20x25 mts/hembra	BL	-	1	6

Poliamida

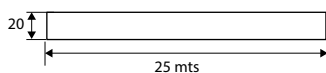

TIRACORDÓN CORTINA C/AGUJERO CT18

	Código	8431488	Medida	Acabado			€uros
Caja	73358	733586	45x30 mm	BL	-	25	125
Blister	92336	923369	45x30 mm	BL	2	-	10

Nylon

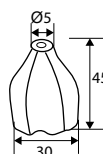

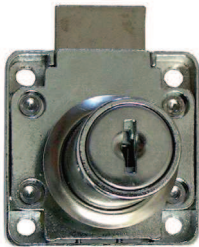

CERRADURA MUEBLE CM1

	Código	8431488	Medida A	Acabado				€uros
Caja	11131	111315	26 mm	CB	-	1	12	
	11133	111339	32 mm	CB	-	1	12	
Blister	91095	910956	26 mm	CB	1	-	10	
	91096	910963	32 mm	CB	1	-	10	

CERRADURA MUEBLE CM1 (LLAVES IGUALES)

	Código	8431488	Medida A	Acabado				€uros
Caja	11132	111322	26 mm	CB	-	1	12	

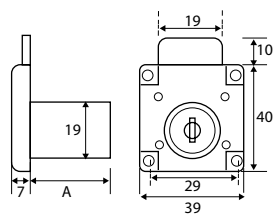

Zamak



CERRADURA ARMARIO CM9

	Código	8431488	Medida	Acabado				€uros
Caja	11166	111667	22 mm	CB	-	1	12	
Blister	91878	918785	22 mm	CB	1	-	10	



CERRADURA ARMARIO CM9 (LLAVES IGUALES)

	Código	8431488	Medida	Acabado				€uros
Caja	11170	111704	22 mm	CB	-	1	12	

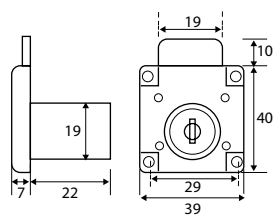

Zamak



CERRADURA MUEBLE GANCHO CM2

	Código	8431488	Medida	Acabado				€uros
Caja	11147	111476	22 mm	CB	-	1	12	
Blister	91322	913223	22 mm	CB	1	-	10	

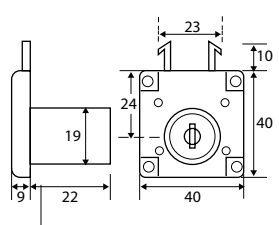
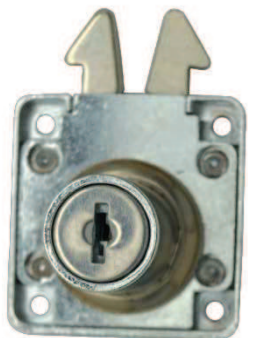

Zamak



CERRADURA TAQUILLA CM14

	Código	8431488	Modelo	Acabado			€uros
Caja	11171	111711	MK1	CB	-	1 12	
	11172	111728	MK2	CB	-	1 12	
	11173	111735	MK3	CB	-	1 12	

Zamak



Tres grupos de amaestramiento
Incluye resbalón

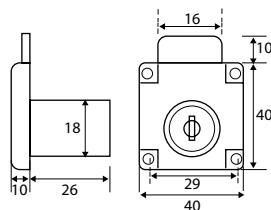

LLAVE P/CERRADURA TAQUILLA CM14

	Código	8431488	Modelo	Acabado			€uros
Caja	11174	111742	MAESTRA MK1	VE	-	1 12	
	11175	111759	MAESTRA MK2	VE	-	1 12	
	11176	111766	MAESTRA MK3	VE	-	1 12	
	11177	111773	GRAN MAESTRA MK1, MK2, MK3	AZ	-	1 12	

Latón



CERRADERO ESCUADRA CM11

	Código	8431488	Tipo	Acabado			€uros
Caja	11139	111391	ESCUADRA	CB	-	25 250	
Blister	91097	910970	ESCUADRA	CB	4	- 10	

Acero

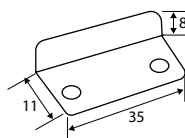

LLAVES IGUALES P/CERRADURA MUEBLE CM12

	Código	8431488	Medida	Acabado			€uros
Caja	11143	111438	12 mm	NI	-	50 500	

Latón





CERRADURA EMBUTIR CM15



	Código	8431488	Medida A	Acabado			€uros
Caja	11182	111827	15 mm	LP	-	12	120
	11183	111834	20 mm	LP	-	12	120
	11184	111841	25 mm	LP	-	12	120
	11185	111858	30 mm	LP	-	12	120
	11186	111865	35 mm	LP	-	12	120
	11187	111872	40 mm	LP	-	12	120
Blister	92338	923383	15 mm	LP	1	-	10
	92339	923390	20 mm	LP	1	-	10
	92340	923406	25 mm	LP	1	-	10
	92341	923413	30 mm	LP	1	-	10
	92342	923420	35 mm	LP	1	-	10
	92343	923437	40 mm	LP	1	-	10

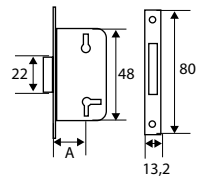

Llave 35 mm

Latón (Frente)



CERRADURA SOBREPONER CM16

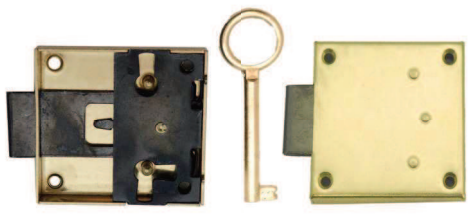

	Código	8431488	Medida A	Acabado			€uros
Caja	11188	111889	20 mm	LTD	-	12	120
	11189	111896	25 mm	LTD	-	12	120
	11190	111902	30 mm	LTD	-	12	120
	11191	111919	35 mm	LTD	-	12	120
	11192	111926	40 mm	LTD	-	12	120
Blister	92344	923444	20 mm	LTD	1	-	10
	92345	923451	25 mm	LTD	1	-	10
	92346	923468	30 mm	LTD	1	-	10
	92347	923475	35 mm	LTD	1	-	10
	92348	923482	40 mm	LTD	1	-	10

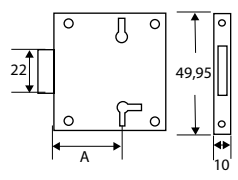

Llave 42 mm

Acero



CERRADURA SOBREPONER CM17



	Código	8431488	Medida	Acabado			€uros
Caja	11180	111803	22 mm	LTD	-	12	120
Blister	92337	923376	22 mm	LTD	1	-	10

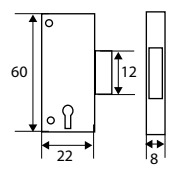

Llave 35 mm

Acero



CERRADURA FALLEBA CM18



	Código	8431488	Medida	Acabado			€uros
Caja	11193	111933	18,5 mm	BL	-	12	120
	11194	111940	18,5 mm	MA	-	12	120
Blister	92349	923499	18,5 mm	BL	1	-	10
	92350	923505	18,5 mm	MA	1	-	10

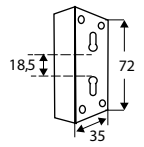

Llave 42 mm

Plástico



CERRADURA MUEBLE HEBILLA CM19

	Código	8431488	Medida AxB	Acabado				Euros
Caja	11195	111957	80x32 mm	CB	-	1	20	
	11196	111964	94x32 mm	CB	-	1	20	
	11197	111971	110x40 mm	CB	-	1	20	
Blister	92351	923512	80x32 mm	CB	1	-	10	
	92352	923529	94x32 mm	CB	1	-	10	
	92353	923536	110x40 mm	CB	1	-	10	

Zamak

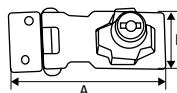

ESCUDO BOCALLAVE ARMARIO EBA1

	Código	8431488	Medida	Acabado				Euros
Caja	30535	305356	31 mm	LP	-	10	250	
	30536	305363	31 mm	NS	-	10	250	

Latón

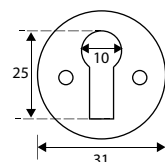

CERRADURA PULSAR CM3

	Código	8431488	Medida	Acabado				Euros
Caja	11137	111377	26-35 mm	CB	-	1	12	
Blister	91098	910987	26-35 mm	CB	1	-	10	

CERRADURA PULSAR CM3 (LLAVES IGUALES)

	Código	8431488	Medida	Acabado				Euros
Caja	11144	111445	26-35 mm	CB	-	1	12	

Zamak

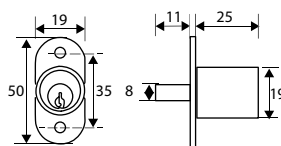

CERRADURA ARCHIVADOR CM10

	Código	8431488	Medida	Acabado				Euros
Caja	11167	111674	18 mm	CB	-	1	12	
Blister	91982	919829	18 mm	CB	1	-	10	

CERRADURA ARCHIVADOR CM10 (LLAVES IGUALES)

	Código	8431488	Medida	Acabado				Euros
Caja	11168	111681	18 mm	CB	-	1	12	

Zamak

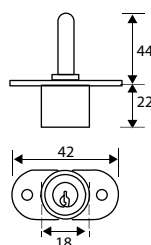



CERRADURA VITRINA 1 PUERTA CM6

	Código	8431488	Medida	Acabado				€uros
	11148	111483	32x35 mm	CB	-	1	12	
<i>Blister</i>	91323	913230	32x35 mm	CB	1	-	10	

CERRADURA VITRINA CM6 (LLAVES IGUALES)

	Código	8431488	Medida	Acabado				€uros
	11150	111506	32x35 mm	CB	-	1	12	

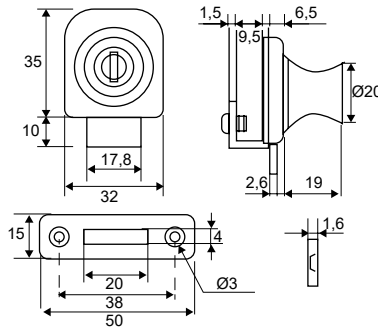

Zamak

CROMO BRILLO

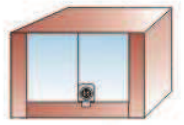

CERRADURA VITRINA 2 PUERTAS CM7

	Código	8431488	Medida	Acabado				€uros
	11149	111490	48x35 mm	CB	-	1	12	
<i>Blister</i>	91324	913247	48x35 mm	CB	1	-	10	

CERRADURA VITRINA CM7 (LLAVES IGUALES)

	Código	8431488	Medida	Acabado				€uros
	11151	111513	48x35 mm	CB	-	1	12	

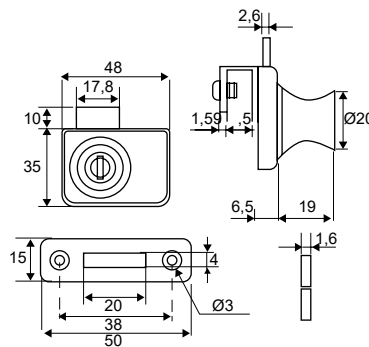

Zamak

CROMO BRILLO

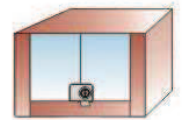

CERRADURA VITRINA CM8

	Código	8431488	Medida	Acabado				€uros
	11138	111384	120 mm	CB	-	1	12	
<i>Blister</i>	91099	910994	120 mm	CB	1	-	10	

CERRADURA VITRINA CM8 (LLAVES IGUALES)

	Código	8431488	Medida	Acabado				€uros
	11142	111421	120 mm	CB	-	1	12	

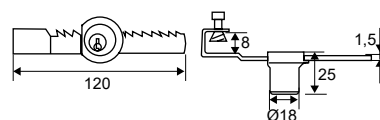

Zamak

CROMO BRILLO

CERRADURA BUZÓN RECTA CM4

	Código	8431488	Medida A	Acabado				€uros
Caja	11134	111346	20 mm	CB	-	1	12	
	11136	111360	30 mm	CB	-	1	12	
Blister	91100	911007	20 mm	CB	1	-	10	
	91101	911014	30 mm	CB	1	-	10	



CERRADURA BUZÓN CM4 (LLAVES IGUALES)

	Código	8431488	Medida A	Acabado				€uros
Caja	11145	111452	20 mm	CB	-	1	12	
	11169	111698	30 mm	CB	-	1	12	

Zamak

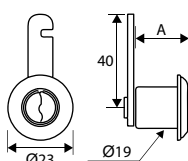

CERRADURA BUZÓN CURVA CM5

	Código	8431488	Medida	Acabado				€uros
Caja	11135	111353	20 mm	CB	-	1	12	
Blister	91102	911021	20 mm	CB	1	-	10	



CERRADURA BUZÓN CM5 (LLAVES IGUALES)

	Código	8431488	Medida	Acabado				€uros
Caja	11146	111469	20 mm	CB	-	1	12	

Zamak

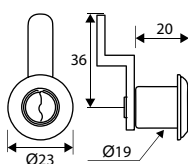

CERRADURA COMBINACIÓN TAQUILLA CM13

	Código	8431488	Medida	Acabado				€uros
Caja	11178	111780	35 mm	CB	-	1	25	
	11179	111797	35 mm	NE	-	1	25	
Blister	92273	922737	35 mm	CB	1	-	10	
	92274	922744	35 mm	NE	1	-	10	

Zamak

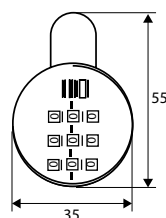



RUEDA SUPERIOR ARMARIO RUA4



	Código	8431488	Medida	Acabado				€uros
Caja	68217	682174	46x39 mm	ZN	-	10	100	
Blister	91649	916491	46x39 mm	ZN	1	-	10	

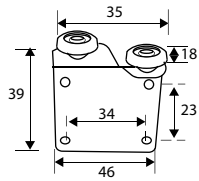

Acero

ZINCADO

RUEDA SUPERIOR ARMARIO RUA1



	Código	8431488	Medida	Acabado				€uros
Caja	68214	682143	65x55 mm	NE	-	10	50	
Blister	91652	916521	65x55 mm	NE	1	-	10	

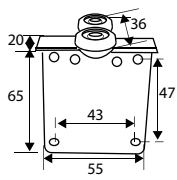

Acero

NEGRO

RUEDA SUPERIOR ARMARIO RUA2



	Código	8431488	Medida	Acabado				€uros
Caja	68215	682150	21x44 mm	ZN	-	10	100	
Blister	91653	916538	21x44 mm	ZN	1	-	10	

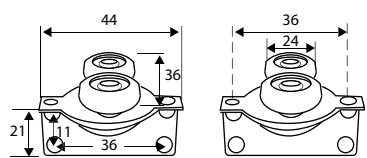

Acero

ZINCADO

FRENO SUPERIOR ARMARIO RUA6



	Código	8431488	Medida	Acabado				€uros
Caja	68220	682204	30x30 mm	ZN	-	10	100	
Blister	91650	916507	30x30 mm	ZN	1	-	10	

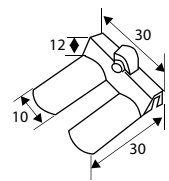

Acero

ZINCADO

RUEDA INFERIOR ARMARIO RUA3-M



	Código	8431488	Tipo/Medida	Acabado				€uros
Caja	68216	682167	macho/85x80 mm	NE	-	10	50	
Blister	91651	916514	macho/85x80 mm	NE	1	-	10	

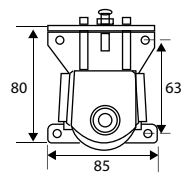

Acero

NEGRO

RUEDA INFERIOR ARMARIO RUAS

	Código	8431488	Tipo/Medida	Acabado				€uros
Caja	68218	682181	macho/100x76 mm	ZN	-	10	30	
	68219	682198	hembra/100x76 mm	ZN	-	10	30	
Blister	91647	916477	macho/100x76 mm	ZN	1	-	10	
	91648	916484	Hembra/100x76 mm	ZN	1	-	10	

Acero



ZINCADO

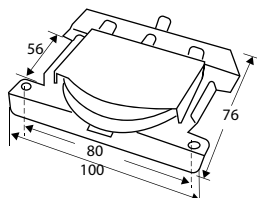

68218

68219

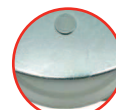

macho



hembra

POLEA PUERTA CORREDERA POL8

	Código	8431488	Medida	Acabado				€uros
Caja	89045	890456	25 mm	LT	-	25	250	
	89046	890463	35 mm	LT	-	25	250	
Blister	91550	915500	25 mm	LT	2	-	10	
	91551	915517	35 mm	LT	2	-	10	

Acero



LATÓN

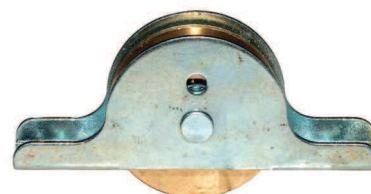
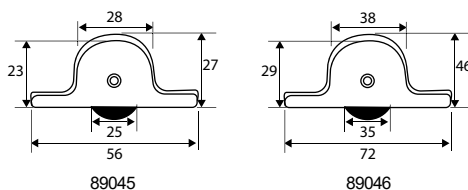

CARRIL SUELO POL10

	Código	8431488	Medida	Acabado				€uros
Caja	89068	890685	2 mts	LTD	-	5	-	
	89069	890692	2 mts	GV	-	5	-	

Acero



LATONADO GALVANIZADO

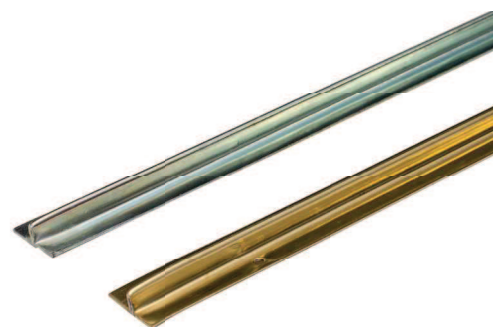
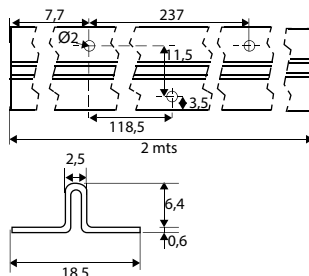

POLEA SUPERIOR ESCUADRA POL9

	Código	8431488	Medida	Acabado				€uros
Caja	89082	890821	43x12 mm	BC	-	25	625	
Blister	91972	919720	43x12 mm	BC	2	-	10	

Acero



BICROMATADO

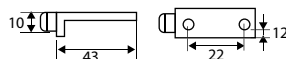



CIERRE 2 RODILLOS GOMA IM1



	Código	8431488	Medida	Acabado				€uros
Caja	10089	100890	1 mm	BC	-	100	1000	
	10891	108919	1 mm	ZN	-	100	1000	
	10894	108940	1 mm	CU	-	100	1000	
Blister	90271	902715	1 mm	BC	2	-	10	
	90272	902722	1 mm	ZN	2	-	10	
	90273	902739	1 mm	CU	2	-	10	

Incluye tornillos en el blister

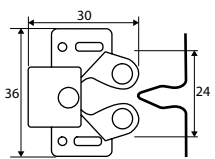

Acero
 BICROMATADO ZINCADO CUERO

CIERRE BOLA IM6

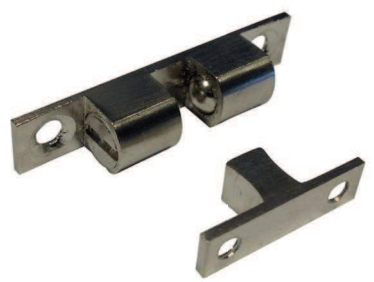

	Código	8431488	Medida A	Acabado				€uros
Caja	10244	102443	44 mm	LT	-	25	250	
	10250	102504	50 mm	LT	-	25	250	
	10270	102702	70 mm	LT	-	25	250	
	10245	102450	44 mm	NS	-	25	250	
	10246	102467	50 mm	NS	-	25	250	
	10247	102474	70 mm	NS	-	25	250	
Blister	90274	902746	44 mm	LT	2	-	10	
	90275	902753	50 mm	LT	2	-	10	
	90276	902760	70 mm	LT	2	-	10	
	91875	918754	44 mm	NS	2	-	10	
	91876	918761	50 mm	NS	2	-	10	
	91877	918778	70 mm	NS	2	-	10	

Incluye tornillos en el blister

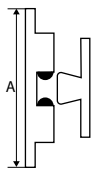

Latón
 LATÓN NIQUEL SATINADO

CIERRE MAGNÉTICO IM2



	Código	8431488	Medida	Acabado				€uros
Caja	10901	109015	42 mm	BL	-	100	1000	
	10911	109114	56 mm	BL	-	50	500	
	10902	109022	42 mm	MA	-	100	1000	
	10912	109121	56 mm	MA	-	50	500	
Blister	90281	902814	42 mm	BL	2	-	10	
	90282	902821	56 mm	BL	2	-	10	
	90283	902838	42 mm	MA	2	-	10	
	90284	902845	56 mm	MA	2	-	10	

Incluye tornillos en el blister

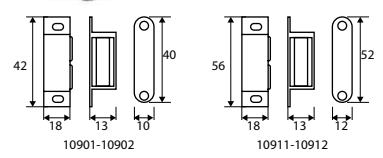

ABS
 BLANCO MARRÓN

IMÁN PIZARRA IM7

	Código	8431488	Medida	Acabado				€uros
Caja	10925	109251	25 mm	BL	-	100	500	
	10926	109268	25 mm	MA	-	100	500	
	10927	109275	25 mm	NE	-	100	500	
	10928	109282	25 mm	RO	-	100	500	
	10929	109299	25 mm	AM	-	100	500	
	10930	090047	25 mm	AZ	-	100	500	
	10931	090054	25 mm	SURTIDO	-	100	500	
Blister	90833	908335	25 mm	SURTIDO	4	-	10	

Nylon



CIERRE MAGNÉTICO REGULABLE IM5

	Código	8431488	Medida	Acabado				€uros
Caja	10932	109329	30x30 mm	BL	-	50	500	
	10933	109336	30x30 mm	MA	-	50	500	
	10934	109343	30x30 mm	NE	-	50	500	
Blister	91210	912103	30x30 mm	BL	2	-	10	
	91211	912110	30x30 mm	MA	2	-	10	
	91212	912127	30x30 mm	NE	2	-	10	

ABS



Incluye placa y tornillos en el blister

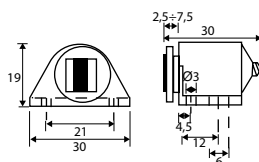

CIERRE MAGNÉTICO C/MUELLE IM3

	Código	8431488	Medida	Acabado				€uros
Caja	10907	109077	47x43 mm	BL	-	100	1000	
	10908	109084	47x43 mm	NE	-	100	1000	
Blister	90285	902852	47x43 mm	BL	2	-	10	
	90286	902869	47x43 mm	NE	2	-	10	

ABS



Incluye placa y tornillos en el blister

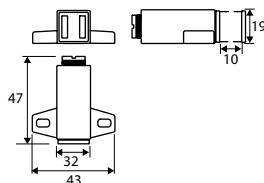

CIERRE TOCA-TOCA IM4

	Código	8431488	Medida	Acabado				€uros
Caja	10903	109039	35x28 mm	BL	-	25	500	
	10904	109046	35x28 mm	MA	-	25	500	
Blister	90277	902777	35x28 mm	BL	2	-	10	
	90278	902784	35x28 mm	MA	2	-	10	

Acero/ABS

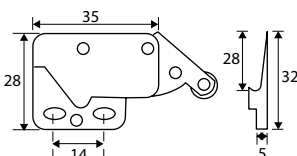



AMORTIGUADOR EMBUTIR IM13

	Código	843 1488	Medida	Acabado				€uros
Caja	10895	108957	50 mm	BL	-	25	250	
Blister	90543	905433	50 mm	BL	1	-	10	

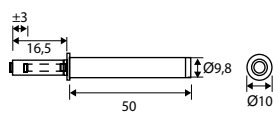

Nylon



TOPE EMBUTIR AMORTIGUADOR IM14

	Código	843 1488	Medida	Acabado				€uros
Caja	10935	109350	10 mm	GR	-	25	625	

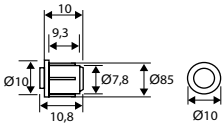

Nylon



TOPE EMBUTIR IMÁN IM15

	Código	843 1488	Medida	Acabado				€uros
Caja	10936	109367	10 mm	GR	-	25	625	



Incluye placa

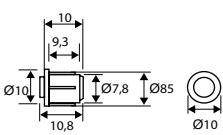

Nylon



TOPE EMBUTIR AMORTIGUADOR REGULABLE IM16

	Código	843 1488	Medida	Acabado				€uros
Caja	10937	109374	26 mm	GR	-	25	625	

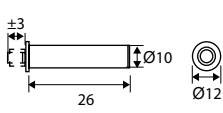

Nylon



TOPE EMBUTIR IMÁN REGULABLE IM17

	Código	843 1488	Medida	Acabado				€uros
Caja	10938	109381	26 mm	GR	-	25	625	



Incluye placa

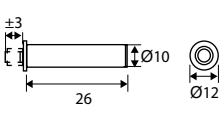

Nylon



TOPE C/BASE AMORTIGUADOR IM18

	Código	8431488	Medida	Acabado				€uros
Caja	10941	109411	12x32 mm	GR	-	25	625	

Nylon



GRIS

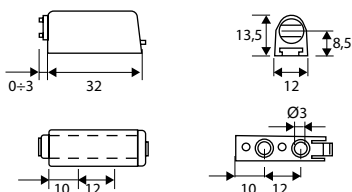

TOPE C/BASE IMÁN IM19

	Código	8431488	Medida	Acabado				€uros
Caja	10942	109428	12x32 mm	GR	-	25	250	

Nylon



GRIS

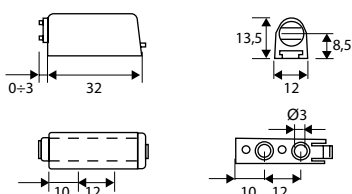

Incluye placa

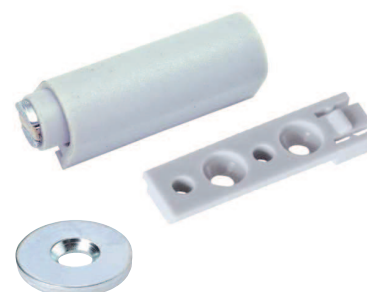

TOPE ALAS AMORTIGUADOR IM20

	Código	8431488	Medida	Acabado				€uros
Caja	10939	109398	28x30 mm	GR	-	25	625	

Nylon



GRIS

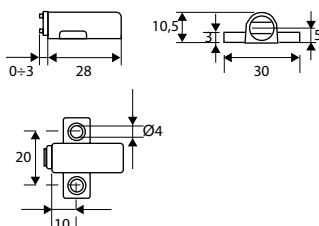

TOPE ALAS IMÁN IM21

	Código	8431488	Medida	Acabado				€uros
Caja	10940	109404	28x30 mm	GR	-	25	250	

Nylon



GRIS

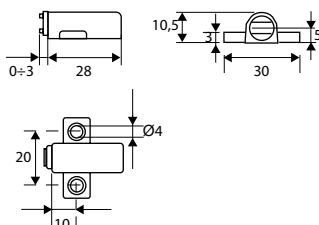

Incluye placa





EXPULSOR C/BASE AMORTIGUADOR IM8



	Código	8431488	Medida/Expulsor	Acabado			€uros
Caja	10914	109145	75 mm/13 mm	GR	-	25	500
	10916	109169	125 mm/40 mm	GR	-	25	500
Blister	90531	905310	75 mm/13 mm	GR	1	-	10
	90532	905327	125 mm/40 mm	GR	1	-	10

Incluye tornillos en el blister

Nylon

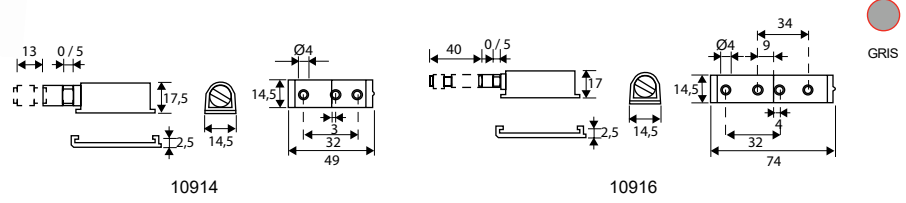

EXPULSOR C/BASE IMÁN IM9

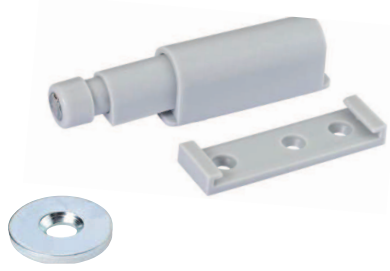

	Código	8431488	Medida/Expulsor	Acabado			€uros
Caja	10913	109138	75 mm/13 mm	GR	-	25	500
	10915	109152	125 mm/40 mm	GR	-	25	500
Blister	90535	905358	75 mm/13 mm	GR	1	-	10
	90536	905365	125 mm/40 mm	GR	1	-	10

Incluye placa y tornillos en el blister

Nylon

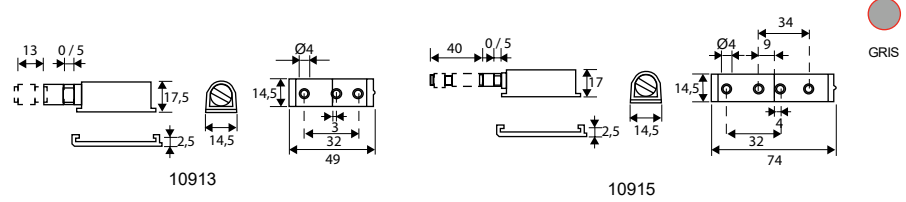

EXPULSOR IMÁN ECO IM22



	Código	8431488	Medida	Acabado			€uros
Caja	10943	109435	80 mm/45 mm	GR	-	10	200

Presentación en tableta de 10 unidades

Nylon

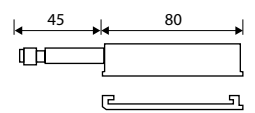

EXPULSOR AMORTIGUADOR ECO IM23



	Código	8431488	Medida	Acabado			€uros
Caja	10944	109442	80 mm/45 mm	GR	-	10	200

Presentación en tableta de 10 unidades

Nylon

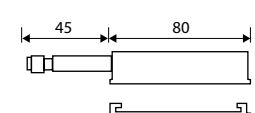

EXPULSOR EMBUTIR AMORTIGUADOR IM10

	Código	8431488	Medida/Expulsor	Acabado			€uros
Caja	10922	109220	50 mm/16 mm	GR	-	25	250
	10918	109183	76 mm/37 mm	GR	-	25	250
Blister	90533	905334	50 mm/16 mm	GR	1	-	10
	90534	905341	76 mm/37 mm	GR	1	-	10

Nylon

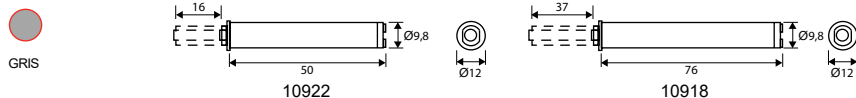

EXPULSOR EMBUTIR IMÁN IM11

	Código	8431488	Medida/Expulsor	Acabado			€uros
Caja	10921	090030	50 mm/16 mm	GR	-	25	250
	10917	109176	76 mm/37 mm	GR	-	25	250
Blister	90537	905372	50 mm/16 mm	GR	1	-	10
	90538	905389	76 mm/37 mm	GR	1	-	10

Nylon

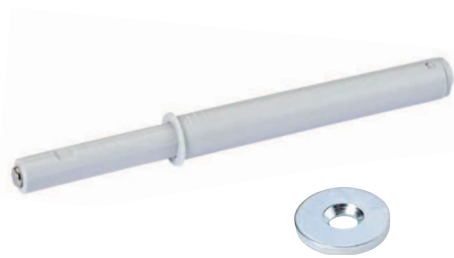
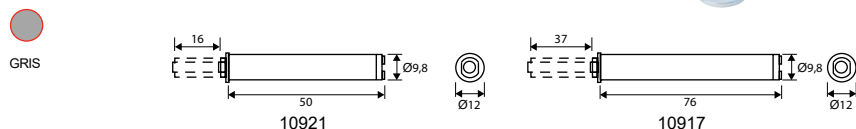

EXPULSOR EMBUTIR REGULABLE AMORTIGUADOR IM38

	Código	8431488	Medida/Expulsor	Acabado			€uros
Caja	10924	109244	50 mm / 17 mm	GR	-	25	250
Blister	90540	905402	50 mm / 17 mm	GR	1	-	10

Nylon



EXPULSOR EMBUTIR REGULABLE IMÁN IM12

	Código	8431488	Medida/Expulsor	Acabado			€uros
Caja	10923	109237	50 mm / 17 mm	GR	-	25	250
Blister	90539	905396	50 mm / 17 mm	GR	1	-	10

Nylon





PLACA EMBUTIR P/IMÁN IM27

	Código	8431488	Tipo/Medida	Acabado				€uros
Caja	00079	000794	embutir/10 mm	NI	-	100	2500	

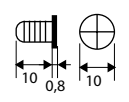

Acero
 NIQUEL



PLACA CLAVO P/IMÁN IM24

	Código	8431488	Tipo/Medida	Acabado				€uros
Caja	00076	000763	clavo/15 mm	ZN	-	100	2500	

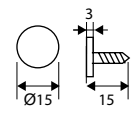

Acero
 ZINCADO



PLACA ADHESIVA P/IMÁN IM25

	Código	8431488	Tipo/Medida	Acabado				€uros
Caja	00077	000770	embutir/15 mm	NI	-	100	2500	

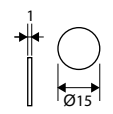

Acero
 NIQUEL

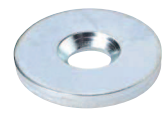

PLACA ATORNILLAR P/IMÁN IM26

	Código	8431488	Tipo/Medida	Acabado				€uros
Caja	00078	000787	atornillar/15 mm	ZN	-	100	2500	0,1080

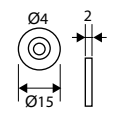

Acero
 ZINCADO



10394

NEODIMIO DISCO ADHESIVO IM29

	Código	8431488	Medida AxB	Máx. Carga	Acabado				€uros
Caja	10394	103945	9,5x1,5 mm	0,76 Kgs	NI	-	12	-	
	10395	103952	12,5x1,5 mm	1,60 Kgs	NI	-	12	-	
Blister	92388	923888	9,5x1,5 mm	0,76 Kgs	NI	6	-	10	
	92389	923895	12,5x1,5 mm	1,60 Kgs	NI	6	-	10	



10395

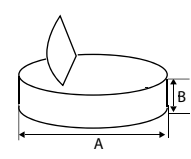

Neodimio
 NIQUEL

NEODIMIO DISCO IM28

	Código	8431488	Medida Ax B	Máx. Carga	Acabado				€uros
Caja	10384	103846	5x3 mm	0,60 Kgs	NI	-	12	-	
	10385	103853	9,5x1,5 mm	0,74 Kgs	NI	-	12	-	
	10386	103860	10x3 mm	1,64 Kgs	NI	-	12	-	
	10387	103877	14x4 mm	3,40 Kgs	NI	-	12	-	
	10388	103884	20x5 mm	6,50 Kgs	NI	-	6	-	
	10389	103891	22x10 mm	12,00 Kgs	NI	-	6	-	
	10390	103907	28x10 mm	13,50 Kgs	NI	-	6	-	
	10391	103914	40x20 mm	11,80 Kgs	NI	-	1	-	
	10392	103921	50x25 mm	75,30 Kgs	NI	-	1	-	
	10393	103938	60x30 mm	200,00 Kgs	NI	-	1	-	
Blister	92381	923819	5x3 mm	0,60 Kgs	NI	6	-	10	
	92382	923826	9,5x1,5 mm	0,74 Kgs	NI	6	-	10	
	92383	923833	10x3 mm	1,64 Kgs	NI	6	-	10	
	92384	923840	14x4 mm	3,40 Kgs	NI	6	-	10	
	92385	923857	20x5 mm	6,50 Kgs	NI	3	-	10	
	92386	923864	22x10 mm	12,00 Kgs	NI	3	-	10	
	92387	923871	28x10 mm	13,50 Kgs	NI	3	-	10	

Neodimio

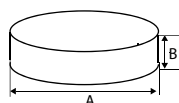

10384



10386



10392



10393

NEODIMIO BLOQUE IM30

	Código	8431488	Medida Ax BxC	Máx. Carga	Acabado				€uros
Caja	10396	103969	20x10x5 mm	5 Kgs	NI	-	12	-	
	10398	103983	30x9x2 mm	2,20 Kgs	NI	-	12	-	
	10399	103990	30x10x5 mm	2,20 Kgs	NI	-	12	-	
	10400	104003	40x20x5 mm	15,10 Kgs	NI	-	6	-	
	10401	104010	40x20x10 mm	19 Kgs	NI	-	6	-	
	92390	923901	20x10x5 mm	5 Kgs	NI	6	-	10	
	92391	923918	30x9x2 mm	2,20 Kgs	NI	6	-	10	
	92392	923925	30x10x5 mm	2,20 Kgs	NI	6	-	10	
	92393	923932	40x20x5 mm	15,10 Kgs	NI	3	-	10	
	92394	923949	40x20x10 mm	19 Kgs	NI	3	-	10	

Neodimio

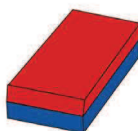
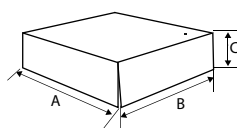
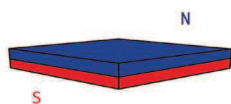

10396



10398



10400



10401



NEODIMIO ARO AVELLANADO IM31



	Código	8431488	Medida Ax B	Máx. Carga	Acabado				€uros
Caja	10404	104041	10x3 mm (8-4)	1,45 Kgs	NI	-	12	-	
	10418	104188	12x6 mm (8-4)	2,15 Kgs	NI	-	12	-	
	10405	104058	15x4 mm (8-4)	3,55 Kgs	NI	-	12	-	
	10406	104065	18x4 mm (8-4)	4,40 Kgs	NI	-	12	-	
	10419	104195	20x3 mm (8-4)	4,00 Kgs	NI	-	12	-	
	10420	104201	25x5 mm (6,7-3,1)	8,55 Kgs	NI	-	6	-	
	10426	104263	25x7 mm (4,5-0,9)	14,00 Kgs	NI	-	6	-	
	10421	104218	30x5 mm (12-6)	9,60 Kgs	NI	-	6	-	
	10425	104256	32x7 mm (5,5-1,1)	25,00 Kgs	NI	-	6	-	
Blister	92395	923956	10x3 mm (8-4)	1,45 Kgs	NI	6	-	10	
	92396	923963	12x6 mm (8-4)	2,15 Kgs	NI	6	-	10	
	92397	923970	15x4 mm (8-4)	3,55 Kgs	NI	6	-	10	
	92398	923987	18x4 mm (8-4)	4,40 Kgs	NI	6	-	10	
	92399	923994	20x3 mm (8-4)	4,00 Kgs	NI	6	-	10	
	92400	924007	25x5 mm (6,7-3,1)	8,55 Kgs	NI	3	-	10	
	92401	924014	30x5 mm (12-6)	9,60 Kgs	NI	3	-	10	
	92402	924021	32x7 mm (5,5-1,1)	25,00 Kgs	NI	3	-	10	

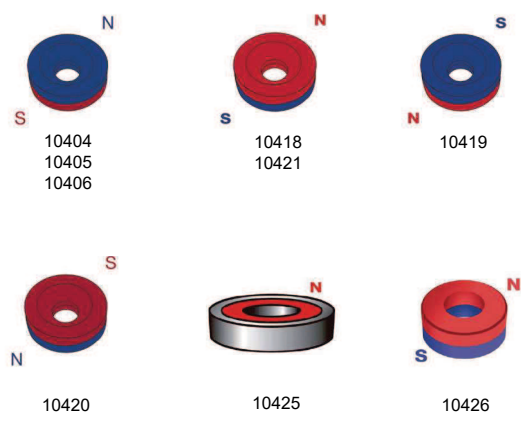
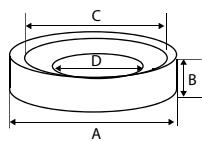

Neodimio
 NIQUEL

NEODIMIO GANCHO IM32



	Código	8431488	Medida Ax B	Máx. Carga	Acabado				€uros
Caja	10408	104089	16x9,5 mm	4,30 Kgs	NI	-	6	-	
	10409	104096	20x14 mm	12,00 Kgs	NI	-	6	-	
	10410	959337	25x20 mm	20,00 Kgs	NI	-	6	-	

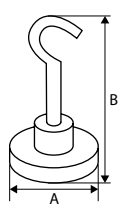

Métrica gancho
 10408: M4
 10409: M4
 10410: M4

Neodimio
 NIQUEL

FERRITA DISCO IM34

	Código	8431488	Medida AxB	Máx. Carga	Acabado				€uros
Caja	10411	104119	12x2,5 mm	0,57 Kgs	NE	-	12	-	
	10413	104133	22x3 mm	1,00 Kg	NE	-	12	-	
	10414	104140	25x5 mm	2,20 Kgs	NE	-	12	-	
Blister	92403	924038	12x2,5 mm	0,57 Kgs	NE	6	-	10	
	92404	924045	22x3 mm	1,00 Kg	NE	6	-	10	
	92405	924052	25x5 mm	2,20 Kgs	NE	6	-	10	



10411



10414

Ferrita



NEGRO

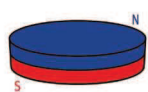

FERRITA BLOQUE IM35

	Código	8431488	Medida AxB	Máx. Carga	Acabado				€uros
Caja	10415	104157	20x10x5 mm	0,80 Kgs	NE	-	12	-	
	10416	104164	40x20x10 mm	1,40 Kgs	NE	-	12	-	
Blister	92406	924069	20x10x5 mm	0,80 Kgs	NE	6	-	10	
	92407	924076	40x20x10 mm	1,40 Kgs	NE	6	-	10	



10415



10416

Ferrita



NEGRO

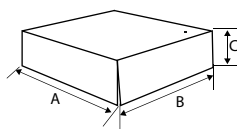
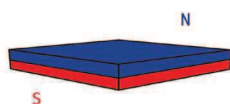

IMÁN PETANCA NEODIMIO IM33

	Código	8431488	Medida	Máx. Carga	Acabado				€uros
Caja	10407	104072	22x15 mm	3,50 Kgs	NE	-	15	-	
Blister	92379	923796	22x15 mm	3,50 Kgs	NE	2	-	10	

Neodimio



NEGRO

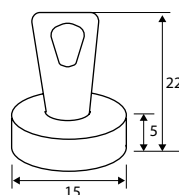



LÁGRIMA ADHESIVA LGM1



	Código	8431488	Medida Ax B	Acabado				€uros
Caja	61921	619217	7x1,5 mm	TR	-	1000	20000	
	61925	619255	8x2,2 mm	TR	-	1000	20000	
	61926	619262	10x1,5 mm	TR	-	1000	20000	
	61922	619224	10x3 mm	TR	-	1000	20000	
Blister	90505	905051	7x1,5 mm	TR	50	-	10	
	91413	914138	8x2,2 mm	TR	25	-	10	
	91414	914145	10x1,5 mm	TR	25	-	10	
	90506	905068	10x3 mm	TR	25	-	10	

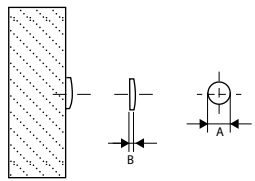

Goma

 TRANSPARENTE

LÁGRIMA ADHESIVA LGM2

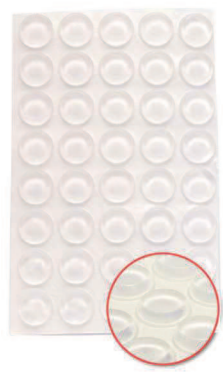

	Código	8431488	Medida	Acabado				€uros
Caja	61923	619231	13x4 mm	TR	-	1000	20000	
Blister	90507	905075	13x4 mm	TR	20	-	10	

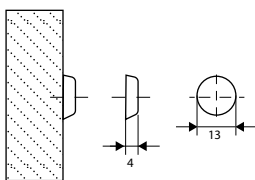

Goma

 TRANSPARENTE

LÁGRIMA ADHESIVA LGM3



	Código	8431488	Medida	Acabado				€uros
Caja	61927	619279	16x7,9 mm	TR	-	160	3200	
Blister	91451	914510	16x7,9 mm	TR	8	-	10	

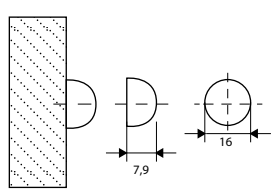

Goma

 TRANSPARENTE

LÁGRIMA ADHESIVA LGM4



	Código	8431488	Medida	Acabado				€uros
Caja	61928	619286	20x6,2 mm	TR	-	105	2100	
Blister	91415	914152	20x6,2 mm	TR	6	-	10	

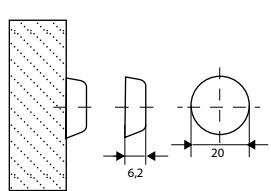

Goma

 TRANSPARENTE

LÁGRIMA ADHESIVA LGM5

	Código	8431488	Medida	Acabado			€uros
Caja	61929	619293	10x10x2,5 mm	TR	-	550	11000
Blister	91416	914169	10x10x2,5 mm	TR	25	-	10

Goma



TRANSPARENTE

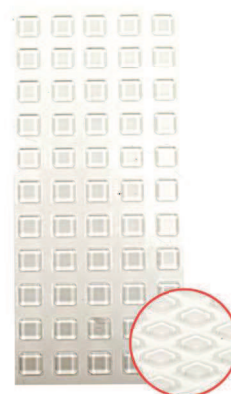
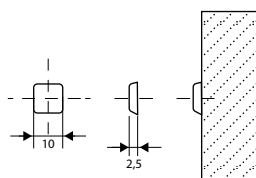

LÁGRIMA ADHESIVA LGM6

	Código	8431488	Medida	Acabado			€uros
Caja	61930	619309	12,5x12,5x5,8 mm	TR	-	480	9600
Blister	91417	914176	12,5x12,5x5,8 mm	TR	20	-	10

Goma



TRANSPARENTE

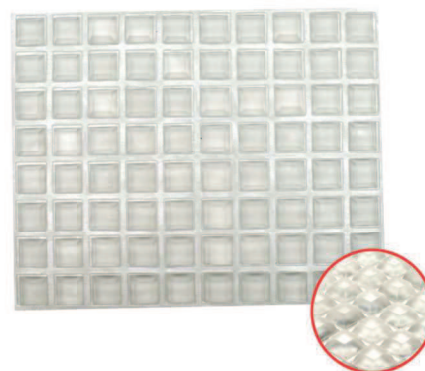
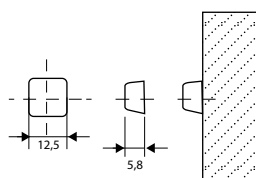

LÁGRIMA ADHESIVA LGM7

	Código	8431488	Medida	Acabado			€uros
Caja	61932	619323	20,5x20,5x7,5 mm	TR	-	90	1800
Blister	91418	914183	20,5x20,5x7,5 mm	TR	6	-	10

Goma



TRANSPARENTE

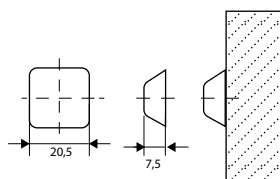

LÁGRIMA EMBUTIR BIMATERIAL LGM8

	Código	8431488	Medida	Acabado			€uros
Caja	61924	619248	8,8x2,5 mm	TR	-	1000	10000
Blister	90632	906324	8,8x2,5 mm	TR	20	-	10

PVC



TRANSPARENTE

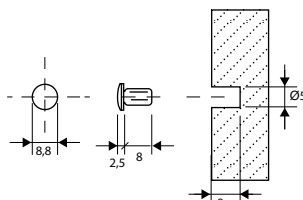

(Taladro 5 mm)





TAPÓN ADHESIVO 13 MM TPN1

Acabado (13 mm)	1000 uds			100 uds			20 uds		
	Código	8431488	€uros	Código	8431488	€uros	Código	8431488	€uros
BLANCO	61941	619415		61901	619019		90906	909066	
BLANCO PORO	61942	619422		61902	619026		90907	909073	
NEGRO	61943	619439		61903	619033		90908	909080	
NEGRO PORO	61944	619446		61904	619040		90909	909097	
GRIS	61945	619453		61905	619057		90910	909103	
CREMA	61946	619460		61906	619064		90911	909110	
HAYA	61947	619477		61907	619071		90912	909127	
ROBLE	61948	619484		61908	619088		90913	909134	
PINO	61949	619491		61909	619095		90914	909141	
NOGAL	61950	619507		61910	619101		90915	909158	
CEREZO	61951	619514		61911	619118		90916	909165	
MAPLE	61952	619521		61912	619125		90917	909172	
SAPELI	61953	619538		61913	619132		90918	909189	
WENGUE	61954	619545		61914	619149		90919	909196	
PLATA	61955	619552		61915	619156		90920	909202	
PINTABLE	61956	619569		91429	914299		91420	914206	
CROMADO	61957	619576		91430	914305		91421	914213	
CAOBA	61958	619583		91431	914312		91422	914220	
CEREZO CLARO	61959	619590		91432	914329		91423	914237	
PINO CLARO	61960	619606		91433	914336		91424	914244	
ROBLE CLARO	61972	619729		91434	914343		91425	914251	
ROBLE OSCURO	61973	619736		91435	914350		91426	914268	
CENIZA	61974	619743		91436	914367		91427	914275	
GRIS BEIGE	61975	619750		91437	914374		91428	914282	
GRIS MARENGO	61936	619361		61916	619163		61918	619187	
ANTRACITA	61937	619378		61917	619170		61919	619194	
TEXTIL OSCURO	61938	619385		91823	918235		91826	918266	
TEXTIL CLARO	61939	619392		91824	918242		91827	918273	
TEXTIL BEIGE	61940	619408		91825	918259		91828	918280	
ALUMINIO	62021	620213		62039	620398		62030	620305	
ABEDUL	62022	620220		62040	620404		62031	620312	
NUEZ	62023	620237		62041	620411		62032	620329	
OLMO CLARO	62024	620244		62042	620428		62033	620336	
OLMO OSCURO	62025	620251		62043	620435		62034	620343	
ROBLE BLANCO	62026	620268		62044	620442		62035	620350	
SICOMORO	62027	620275		62045	620459		62036	620367	
WENGUE CENIZA	62028	620282		62046	620466		62037	620374	
FRESNO	62029	620299		62047	620473		62038	620381	

COMPLEMENTOS ARMARIO Y MUEBLE



TAPÓN ADHESIVO 17 MM TPN2

Acabado (17 mm)	600 uds			60 uds			20 uds		
	Código	8431488	€uros	Código	8431488	€uros	Código	8431488	€uros
BLANCO	61981	619811		61961	619613		91438	914381	
NEGRO	61982	619828		61962	619620		91439	914398	
GRIS	61983	619835		61963	619637		91440	914404	
CREMA	61984	619842		61964	619644		91441	914411	
HAYA	61985	619859		61965	619651		91442	914428	
ROBLE	61986	619866		61966	619668		91443	914435	
PINO	61987	619873		61967	619675		91444	914442	
NOGAL	61988	619880		61968	619682		91445	914459	
MAPLE	61989	619897		61969	619699		91446	914466	
SAPALI	61990	619903		61970	619705		91447	914473	
WENGUE	61991	619910		61971	619712		91448	914480	
CEREZO	61992	619927		91450	914503		91449	914497	
TEXTIL OSCURO	62006	620060		62011	620114		62016	620169	
TEXTIL CLARO	62007	620077		62012	620121		62017	620176	
TEXTIL BEIGE	62008	620084		62013	620138		62018	620183	
GRIS MARENGO	62009	620091		62014	620145		62019	620190	
ANTRACITA	62010	620107		62015	620152		62020	620206	

PVC

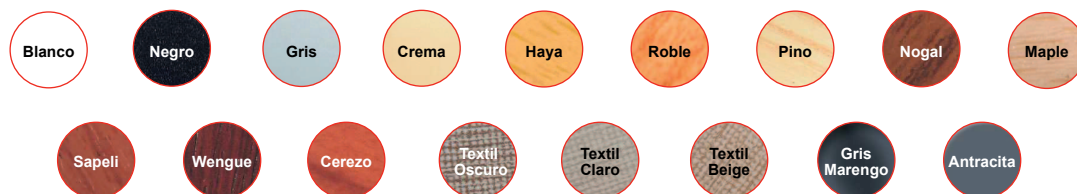

TAPÓN ADHESIVO 25 MM TPN3

Acabado (25 mm)	300 uds			12 uds		
	Código	8431488	€uros	Código	8431488	€uros
BLANCO	61999	619996		91215	912158	
NEGRO	62000	620008		91216	912165	
GRIS	62001	620015		91217	912172	
HAYA	62002	620022		91218	912189	
ROBLE	62003	620039		91219	912196	
CEREZO	62004	620046		91220	912202	
WENGUE	62005	620053		91221	912219	

PVC





TAPÓN ADHESIVO P/BISAGRA TPN4

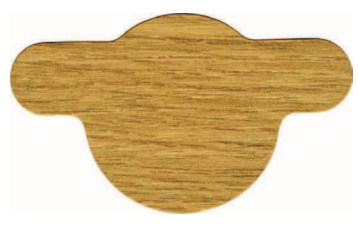

	Código	843 I 488	Medida	Acabado			€uros
Caja	61995	619958	35 mm	BL	-	200	-
	61996	619965	35 mm	GR	-	200	-
	61997	619972	35 mm	RB	-	200	-
	61998	619989	35 mm	HY	-	200	-
Blister	90733	907338	35 mm	BL	8	-	10
	90734	907345	35 mm	GR	8	-	10
	90735	907352	35 mm	RB	8	-	10
	90736	907369	35 mm	HY	8	-	10

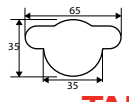

PVC

BLANCO
 GRIS
 ROBLE
 HAYA

TAPÓN PLÁSTICO P/TORNILLO TPN5

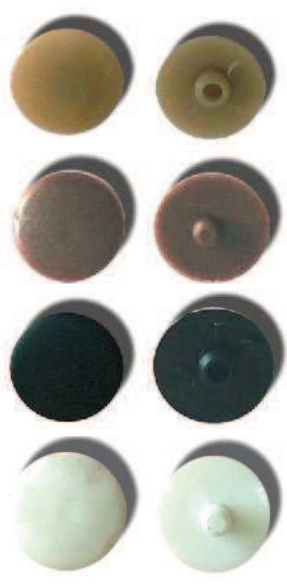

	Código	843 I 488	Medida Allen (A)	Acabado			€uros
Caja	60001	600017	5 mm	BL	-	1000	10000
	60002	600024	5 mm	NE	-	1000	10000
	60003	600031	5 mm	MA	-	1000	10000
	60004	600048	5 mm	BE	-	1000	10000
	60101	601014	7 mm	BL	-	1000	10000
	60102	601021	7 mm	NE	-	1000	10000
	60103	601038	7 mm	MA	-	1000	10000
	60104	601045	7 mm	BE	-	1000	10000
Blister	91703	917030	5 mm	BL	25	-	10
	91704	917047	5 mm	NE	25	-	10
	91705	917054	5 mm	MA	25	-	10
	91706	917061	5 mm	BE	25	-	10
	91707	917078	7 mm	BL	25	-	10
	91708	917085	7 mm	NE	25	-	10
	91709	917092	7 mm	MA	25	-	10
	91710	917108	7 mm	BE	25	-	10

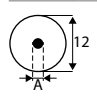

Polietileno

BLANCO
 NEGRO
 MARRÓN
 BEIGE

TAPÓN PLÁSTICO ENVOLVENTE TPN6



	Código	843 I 488	Medida	Acabado			€uros
Caja	60105	601052	14 mm	BL	-	100	2500
	60106	601069	14 mm	MA	-	100	2500
	60107	601076	14 mm	GR	-	100	2500
Blister	91222	912226	14 mm	BL	8	-	10
	91223	912233	14 mm	MA	8	-	10
	91224	912240	14 mm	GR	8	-	10

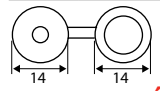

Polipropileno

BLANCO
 MARRÓN
 GRIS

TAPÓN MÓDULO CREMALLERA TPN7

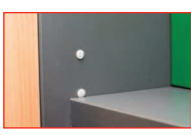

	Código	843 I 488	Medida	Acabado			€uros
Caja	60108	601083	5 mm	BL	-	1000	10000
	60109	601090	5 mm	GR	-	1000	10000
Blister	91987	919874	5 mm	BL	10	-	10
	91988	919881	5 mm	GR	10	-	10

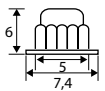

Polietileno

BLANCO
 GRIS

CANTO MELAMINA CAN2

	Código	8431488	Medida	Acabado				€uros
	62100	621005	22x5 mts	BLANCO	-	1	10	
	62101	621012	22x5 mts	NEGRO	-	1	10	
	62102	621029	22x5 mts	GRIS	-	1	10	
	62103	621036	22x5 mts	PINO	-	1	10	
	62104	621043	22x5 mts	HAYA	-	1	10	
	62105	621050	22x5 mts	WENGUE	-	1	10	
	62106	621067	22x5 mts	NOGAL	-	1	10	
	62107	621074	22x5 mts	SAPELI	-	1	10	
	62108	621081	22x5 mts	CEREZO	-	1	10	
	62109	621098	22x5 mts	ROBLE	-	1	10	
	62111	621111	22x5 mts	ROBLE CLARO	-	1	10	
	62112	621128	22x5 mts	ROBLE OSCURO	-	1	10	
Blister	91606	916064	22x5 mts	BLANCO	1	-	10	
	91607	916071	22x5 mts	NEGRO	1	-	10	
	91608	916088	22x5 mts	GRIS	1	-	10	
	91609	916095	22x5 mts	PINO	1	-	10	
	91610	916101	22x5 mts	HAYA	1	-	10	
	91611	916118	22x5 mts	WENGUE	1	-	10	
	91612	916125	22x5 mts	NOGAL	1	-	10	
	91613	916132	22x5 mts	SAPELI	1	-	10	
	91614	916149	22x5 mts	CEREZO	1	-	10	
	91632	916323	22x5 mts	ROBLE	1	-	10	
	91633	916330	22x5 mts	ROBLE CLARO	1	-	10	
	91634	916347	22x5 mts	ROBLE OSCURO	1	-	10	

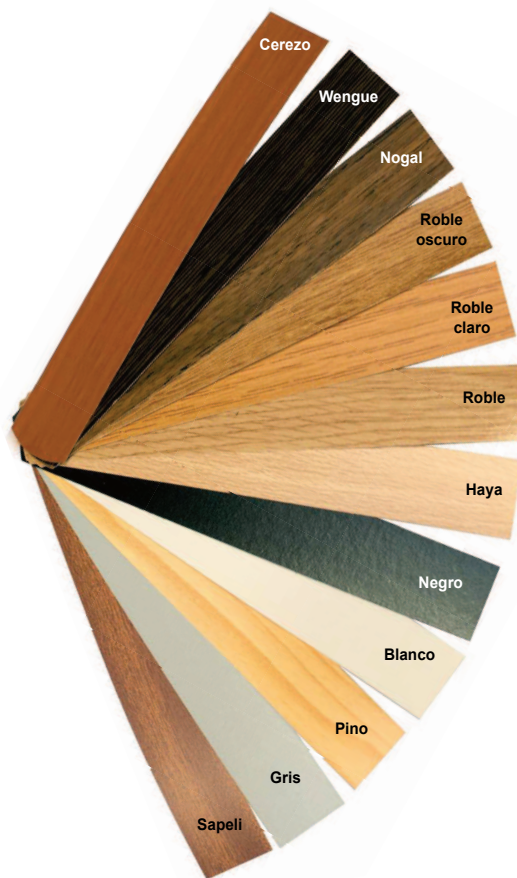

COMPLEMENTOS ARMARIO Y MUEBLE

CANTO ADHESIVO CAN1

	Código	8431488	Medida	Acabado				€uros
	62113	621135	19x5 mts	BLANCO	-	1	10	
	62114	621142	19x5 mts	NEGRO	-	1	10	
	62115	621159	19x5 mts	GRIS	-	1	10	
	62116	621166	19x5 mts	PINO	-	1	10	
	62117	621173	19x5 mts	HAYA	-	1	10	
	62118	621180	19x5 mts	WENGUE	-	1	10	
	62119	621197	19x5 mts	NOGAL	-	1	10	
	62121	621210	19x5 mts	SAPELI	-	1	10	
	62122	621227	19x5 mts	CEREZO	-	1	10	
	62123	621234	19x5 mts	ROBLE	-	1	10	
	62124	621241	19x5 mts	ROBLE CLARO	-	1	10	
	62126	621265	19x5 mts	ROBLE OSCURO	-	1	10	
Blister	91635	916354	19x5 mts	BLANCO	1	-	10	
	91636	916361	19x5 mts	NEGRO	1	-	10	
	91637	916378	19x5 mts	GRIS	1	-	10	
	91638	916385	19x5 mts	PINO	1	-	10	
	91639	916392	19x5 mts	HAYA	1	-	10	
	91640	916408	19x5 mts	WENGUE	1	-	10	
	91641	916415	19x5 mts	NOGAL	1	-	10	
	91642	916422	19x5 mts	SAPELI	1	-	10	
	91643	916439	19x5 mts	CEREZO	1	-	10	
	91644	916446	19x5 mts	ROBLE	1	-	10	
91645	916453	19x5 mts	ROBLE CLARO	1	-	10		
91646	916460	19x5 mts	ROBLE OSCURO	1	-	10		

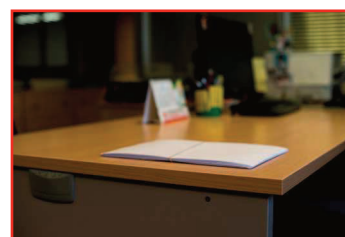

Melamina

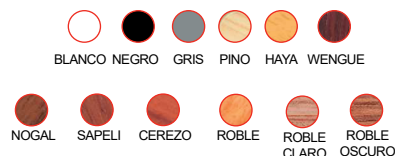

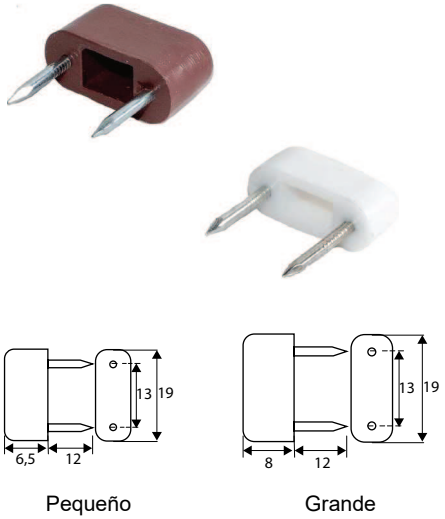

TOPE 2 PUNTAS TPM1

	Código	843 1488	Medida	Acabado			€uros
Caja	60601	606019	pequeño	BL	-	1000	10000
	60603	606033	pequeño	BL	-	100	5000
	60611	606118	grande	BL	-	1000	10000
	60613	606132	grande	BL	-	100	5000
	60602	606026	pequeño	MA	-	1000	10000
	60604	606040	pequeño	MA	-	100	5000
	60612	606125	grande	MA	-	1000	10000
Blister	60614	606149	grande	MA	-	100	5000
	90370	903705	pequeño	BL	8	-	10
	90371	903712	grande	BL	8	-	10
	90372	903729	pequeño	MA	8	-	10
	90373	903736	grande	MA	8	-	10

Polipropileno



PORTAESTANTE VITRINA PES

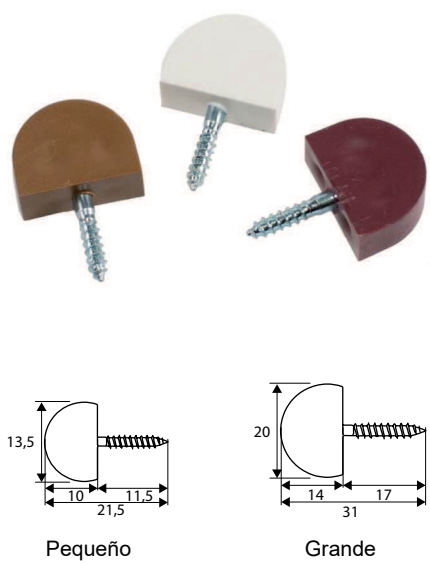

	Código	843 1488	Medida	Acabado			€uros
Caja	60401	604015	pequeño	BL	-	1000	10000
	60405	604053	pequeño	BL	-	100	5000
	60411	604114	grande	BL	-	500	5000
	60415	604152	grande	BL	-	100	5000
	60402	604022	pequeño	MA	-	1000	10000
	60406	604060	pequeño	MA	-	100	5000
	60412	604121	grande	MA	-	500	5000
	60416	604169	grande	MA	-	100	5000
	60403	604039	pequeño	BE	-	1000	10000
	60407	604077	pequeño	BE	-	100	5000
	60413	604138	grande	BE	-	500	5000
	60417	604176	grande	BE	-	100	5000
	60418	604183	pequeño	GR	-	1000	10000
	60420	604206	pequeño	GR	-	100	5000
	60419	604190	grande	GR	-	500	5000
60421	604213	grande	GR	-	100	5000	
Blister	90363	903637	pequeño	BL	8	-	10
	90362	903620	grande	BL	4	-	10
	90365	903651	pequeño	MA	8	-	10
	90364	903644	grande	MA	4	-	10
	90367	903675	pequeño	BE	8	-	10
	90366	903668	grande	BE	4	-	10
	92270	922706	pequeño	GR	8	-	10
92271	922713	grande	GR	4	-	10	

Polipropileno



PORTAESTANTE CLAVAR PE16

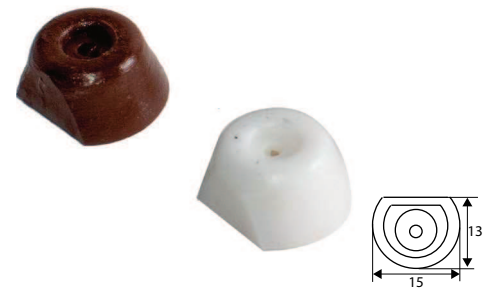

	Código	843 1488	Medida	Acabado			€uros
Caja	60701	607016	15 mm	BL	-	1000	10000
	60702	607023	15 mm	MA	-	1000	10000

Polietileno



PORTAESTANTE ARANDELA PE3

	Código	8431488	Medida	Acabado				€uros
Caja	31011	310114	5x16 mm	LTD	-	1000	5000	
	31021	310213	5x16 mm	LTD	-	100	5000	
	31013	310138	5x16 mm	ZN	-	1000	5000	
	31023	310237	5x16 mm	ZN	-	100	10000	
Blister	90352	903521	5x16 mm	LTD	12	-	10	
	90353	903538	5x16 mm	ZN	12	-	10	

Acero

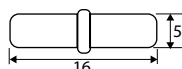

PORTAESTANTE ARANDELA PE3

	Código	8431488	Medida A	Acabado				€uros
Caja	31017	310176	3-5x16 mm	ZN	-	1000	10000	
	31014	310145	4-5x16 mm	ZN	-	1000	10000	
Blister	92374	923741	3-5x16 mm	ZN	12	-	10	
	90725	907253	4-5x16 mm	ZN	12	-	10	

Acero

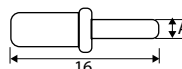

PORTAESTANTE CRISTAL PE4

	Código	8431488	Medida A	Acabado				€uros
Caja	31016	310169	3x16 mm	ZN	-	500	12500	
	31015	310152	5x16 mm	ZN	-	500	12500	

Acero

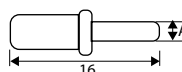

PORTAESTANTE PE2

	Código	8431488	Medida	Acabado				€uros
Caja	31609	316093	5 mm	NI	-	100	1000	
Blister	91714	917146	5 mm	NI	4	-	10	

Zamak

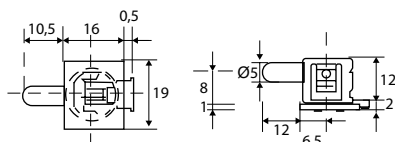



PORTAESTANTE SAFETY PE6

	Código	8431488	Medida	Acabado				€uros
Caja	60301	603018	5 mm	BL	-	1000	5000	
	60307	603070	5 mm	BL	-	100	5000	
	60302	603025	5 mm	MA	-	1000	5000	
	60308	603087	5 mm	MA	-	100	5000	
	60303	603032	5 mm	TR	-	1000	5000	
Blister	90359	903590	5 mm	BL	8	-	10	
	90360	903606	5 mm	MA	8	-	10	
	90361	903613	5 mm	TR	8	-	10	

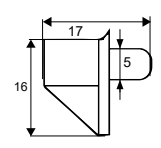

Polipropileno
 BLANCO MARRÓN TRANSPARENTE



PORTAESTANTE SAFETY PE6

	Código	8431488	Medida	Acabado				€uros
Caja	60304	603049	3 mm	TR	-	1000	5000	
	60311	603117	3 mm	TR	-	100	5000	
Blister	90723	907239	3 mm	TR	8	-	10	

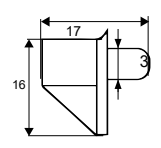

Polipropileno
 TRANSPARENTE



PORTAESTANTE SAFETY LARGO PE7

	Código	8431488	Medida	Acabado				€uros
Caja	60305	603056	5 mm	TR	-	500	2500	
Blister	90724	907246	5 mm	TR	4	-	10	

Tablero 16 mm

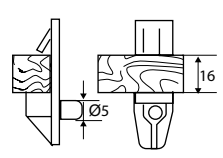

Polipropileno
 TRANSPARENTE



PORTAESTANTE ESCUADRAY CASQUILLO PE8

	Código	8431488	Tipo	Acabado				€uros
Caja	60201	602011	portaestante	BL	-	1000	10000	
	60211	602110	casquillo	BL	-	1000	10000	
	60202	602028	portaestante	MA	-	1000	10000	
	60212	602127	casquillo	MA	-	1000	10000	
Blister	90368	903682	portaestante + casquillo	BL	8	-	10	
	90369	903699	portaestante + casquillo	MA	8	-	10	

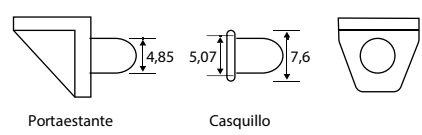

Polipropileno
 BLANCO MARRÓN

PORTAESTANTE PALETA PE1

	Código	8431488	Medida	Acabado				€uros
Caja	31606	316062	5 mm	NI	-	100	2500	
Blister	91711	917115	5 mm	NI	8	-	10	

Zamak



NIQUEL

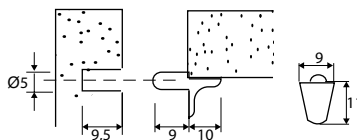

PORTAESTANTE PERNO PE17

	Código	8431488	Medida	Acabado				€uros
Caja	31607	316079	5 mm	NI	-	100	2500	
Blister	91712	917122	5 mm	NI	8	-	10	

Zamak



NIQUEL

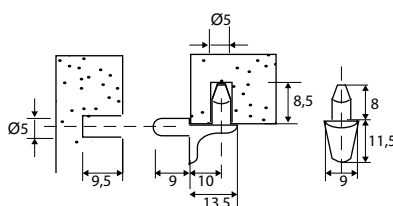

PORTAESTANTE EURO PE18

	Código	8431488	Medida	Acabado				€uros
Caja	31608	316086	5 mm	NI	-	100	2500	
Blister	91713	917139	5 mm	NI	8	-	10	

Zamak



NIQUEL

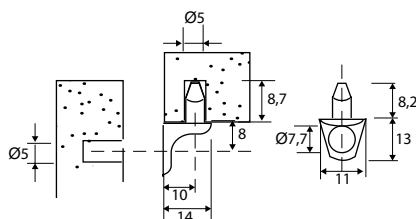

PORTAESTANTE CRISTAL PE9

	Código	8431488	Medida	Acabado				€uros
Caja	31603	316031	5 mm	NI	-	500	2500	
Blister	90635	906355	5 mm	NI	4	-	10	

Zamak



NIQUEL

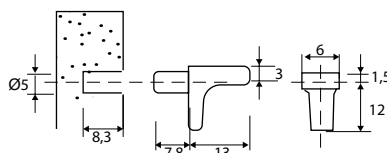



PORTAESTANTE Y CASQUILLO PRESIÓN PE11



	Código	8431488	Tipo	Acabado				€uros
Caja	31511	315119	portaestante	LT	-	250	2500	
	31521	315218	casquillo	LT	-	500	5000	
	31512	315126	portaestante	NI	-	250	2500	
	31522	315225	casquillo	NI	-	500	5000	

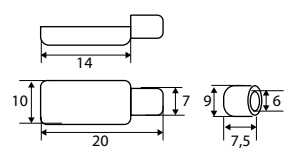

Latón
 LATÓN NÍQUEL

PORTAESTANTE Y CASQUILLO ESTAMPADO PE12



	Código	8431488	Tipo	Acabado				€uros
Caja	31311	313115	portaestante	LTD	-	500	2500	
	31321	313214	casquillo	LTD	-	1000	5000	
Blister	90347	903477	portaestante + casquillo	LTD	4	-	10	

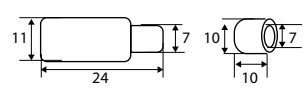

Acero
 LATONADO

PORTAESTANTE Y CASQUILLO ROSCADO PE13



	Código	8431488	Medida	Acabado				€uros
Caja	31411	314112	portaestante	LT	-	250	2500	
	31421	314211	casquillo	LT	-	500	5000	
	31412	314129	portaestante	NI	-	250	2500	
	31422	314228	casquillo	NI	-	500	5000	
Blister	90348	903484	portaestante + casquillo	LT	4	-	10	
	90349	903491	portaestante + casquillo	NI	4	-	10	

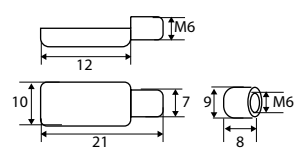

Latón
 LATÓN NÍQUEL

PORTAESTANTE REDONDO PE14



	Código	8431488	Medida	Acabado				€uros
Caja	31211	312118	14x4x1/8 mm	LT	-	250	2500	
	31212	312125	14x4x1/8 mm	NI	-	250	2500	
Blister	90350	903507	14x4x1/8 mm	LT	4	-	10	
	90351	903514	14x4x1/8 mm	NI	4	-	10	

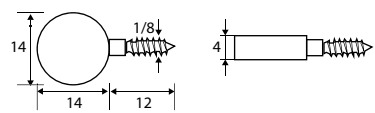

Latón
 LATÓN NÍQUEL

PORTAESTANTE C/GOMA PE10

	Código	8431488	Medida	Acabado				€uros
Caja	31111	311111	5 mm	LT	-	250	2500	
	31112	311128	5 mm	NI	-	250	2500	
Blister	90355	903552	5 mm	LT	4	-	10	
	90356	903569	5 mm	NI	4	-	10	

Latón

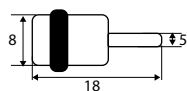

PORTAESTANTE VENTOSA PE15

	Código	8431488	Medida	Acabado				€uros
Caja	31602	316024	5 mm	NI	-	500	2500	
Blister	90358	903583	5 mm	NI	4	-	10	

Zamak

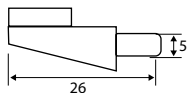

ENGANCHE Ø20 EX5

	Código	8431488	Medida/Tablero	Acabado				€uros
Caja	30823	308234	13x8 mm/16 mm	BL	-	200	2000	

Nylon

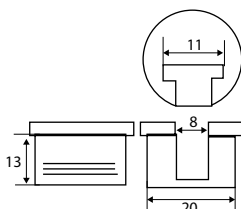

TORNILLO ENGANCHE EX5

	Código	8431488	Medida	Acabado				€uros
Caja	30826	308265	14x6 mm	ZN	-	200	5000	
Blister	90579	905792	14x6 mm	ZN	12	-	10	

Acero

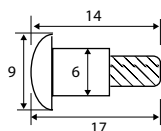

ENGANCHE + TORNILLO EX5

	Código	8431488	Medida/Tablero	Acabado				€uros
Blister	90573	905730	13x8 mm/16 mm	BL	4	-	10	

Enganche: Nylon/Tornillo: Acero





ENGANCHE Ø15 EX1



	Código	8431488	Medida	Acabado				€uros
Caja	30838	308388	10,5x7x14 mm	GR	-	100	1000	

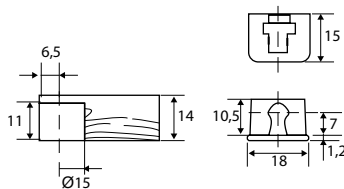

Plástico



GRIS

PERNO ENGANCHE MADERA EX1



	Código	8431488	Medida	Acabado				€uros
Caja	30839	308395	11x9 mm	ZN	-	100	2500	
Blister	91715	917153	enganche + perno	ZN	4	-	10	

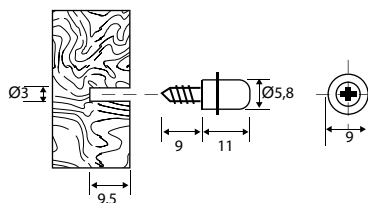

Enganche: Plástico/Perno: Acero



ZINCADO

PERNO ENGANCHE EURO EX1



	Código	8431488	Medida	Acabado				€uros
Caja	30840	308401	11x8,8 mm	ZN	-	100	2500	
Blister	91716	917160	enganche + perno	ZN	4	-	10	

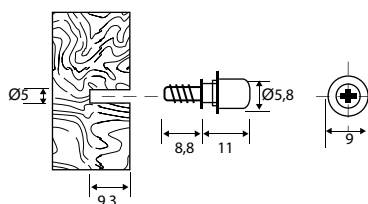

Enganche: Plástico/Perno: Acero



ZINCADO

PERNO ENGANCHE PRESIÓN EX1



	Código	8431488	Medida	Acabado				€uros
Caja	30841	308418	11x12,5 mm	ZN	-	100	2500	
Blister	91717	917177	enganche + perno	ZN	4	-	10	

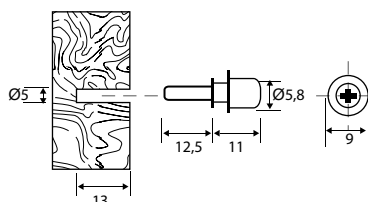

Enganche: Plástico/Perno: Acero



ZINCADO

ENGANCHE Ø18 EX2

	Código	8431488	Medida	Acabado			€uros
Caja	30842	308425	13,4x16 mm	GR	-	100 1000	

Nylon

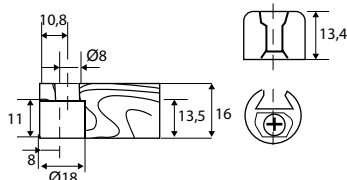

SOPORTE ENGANCHE TACO EX2

	Código	8431488	Medida	Acabado			€uros
Caja	30843	308432	13,3x18 mm	NI	-	100 1000	
Blister	91718	917184	enganche + soporte	NI	4	- 10	

Enganche: Nylon/Soporte: Zamak

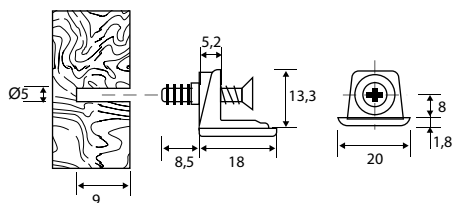

SOPORTE ENGANCHE TORNILLO EX2

	Código	8431488	Medida	Acabado			€uros
Caja	30844	308449	13,3x18 mm	NI	-	100 1000	
Blister	91719	917191	enganche + soporte	NI	4	- 10	

Enganche: Nylon/Soporte: Zamak

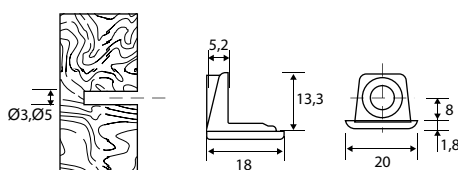



ENGANCHE EXCÉNTRICA Ø20 EX4



	Código	8431488	Medida/Tablero	Acabado			€uros
Caja	30819	308197	13x8 mm/16 mm	NI	-	200	1000
	30822	308227	13x8 mm/16 mm	NE	-	200	1000

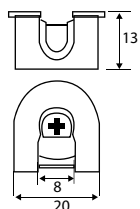

Zamak
 NÍQUEL
 NEGRO

PERNO P/EXCÉNTRICA EX4



	Código	8431488	Medida/Rosca	Acabado			€uros
Caja	30832	308326	6x11 mm/madera	ZN	-	200	5000
Blistar	90572	905723	6x11 mm/madera	ZN	12	-	10

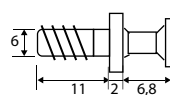

Acero
 ZINCADO

ENGANCHE EXCÉNTRICA Ø20 + PERNO EX4



	Código	8431488	Medida/Tablero	Acabado			€uros
Blistar	90568	905686	13x8 mm/16 mm	NI	4	-	10

Zamak
 NÍQUEL

ENGANCHE EX3



	Código	8431488	Medida	Acabado			€uros
Caja	30852	308524	M6x31,7x18,3 mm	NI	-	25	250

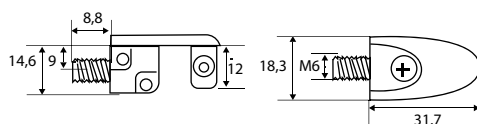

Zamak
 NÍQUEL

EXCÉNTRICA Ø15 EX6

	Código	8431488	Medida /Tablero	Acabado				€uros
Caja	30812	308128	12,5x8 mm/16 mm	ZN	-	200	2000	
	30813	308135	14x9 mm/19 mm	ZN	-	200	2000	

Zamak



ZINCADO

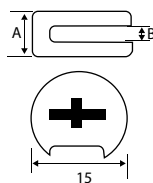

PERNO P/EXCÉNTRICA EX6

	Código	8431488	Medida AxBxC/Rosca	Acabado				€uros
Caja	30814	308142	45x34x11 mm/madera	ZN	-	200	2000	
	30815	308159	42x34x8 mm/M6	ZN	-	200	2000	
Blister	90563	905631	45x34x11 mm/madera	ZN	12	-	10	
	90564	905648	42x34x8 mm/M6	ZN	12	-	10	

Acero



ZINCADO

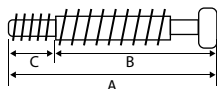

EXCÉNTRICA + PERNO EX6

	Código	8431488	Medida/Rosca	Acabado				€uros
Blister	90561	905617	12,5x8 mm/madera	ZN	4	-	10	
	90562	905624	12,5x8 mm/M6	ZN	4	-	10	

Zamak



ZINCADO



TAPÓN P/EXCÉNTRICA Ø15 EX6

	Código	8431488	Medida	Acabado				€uros
Caja	30816	308166	17 mm	BL	-	200	5000	
	30817	308173	17 mm	MA	-	200	5000	
	30818	308180	17 mm	NE	-	200	5000	
Blister	90565	905655	17 mm	BL	12	-	10	

Polietileno



BLANCO MARRÓN NEGRO

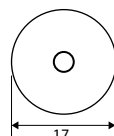



EXCÉNTRICA Ø25 EX7

	Código	8431488	Medida/Perno	Acabado				€uros
Caja	30849	308494	11,7x6,5 mm	ZKN	-	100	1000	
Blíster	91873	918730	11,7x6,5 mm/R Madera	ZKN	4	-	10	
	91874	918747	11,7x6,5 mm/M6	ZKN	4	-	10	

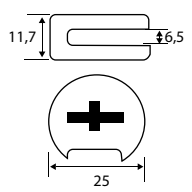

Blíster incluye perno

Zamak

ZAMAK NATURAL



EXCÉNTRICA Ø35 EX8

	Código	8431488	Medida	Acabado				€uros
Caja	30853	308531	16,3x9,4 mm	ZN	-	25	250	

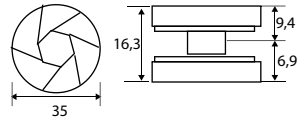

Zamak

ZINCADO

PERNO P/EXCÉNTRICA EX8

	Código	8431488	Medida	Acabado				€uros
Caja	30854	308548	M6x35x10 mm	ZN	-	25	625	

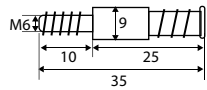

Acero

ZINCADO

TACO GRAFILADO TC1

	Código	8431488	Medida AxBxC	Acabado				€uros
Caja	30836	308364	M6x23x8 mm	LT	-	100	2500	
	30837	308371	M8x28x10 mm	LT	-	100	2500	

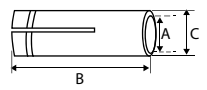

Latón

LATÓN

TUERCA EMBUTIR TRC3

	Código	8431488	Medida MxAxB	Acabado			€uros
Caja	30802	308029	1/4x10x12 mm	BC	-	100 2500	
	30828	308289	M6x12x12 mm	ZN	-	250 2500	
	30829	308296	M6x12x14 mm	ZN	-	250 2500	
	30830	308302	M8x13x16 mm	BC	-	250 1250	
	30835	308357	M10x15x17 mm	BC	-	250 1250	
Blister	90556	905563	M6x12x12 mm	ZN	4	- 10	
	90557	905570	M6x12x14 mm	ZN	4	- 10	
	90558	905587	M8x13x16 mm	BC	4	- 10	
	91378	913780	M10x15x17 mm	BC	4	- 10	

Acero

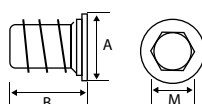

TUERCA EMBUTIR TRC5

	Código	8431488	Medida MxAxB	Acabado			€uros
Caja	30845	308456	M6x10x13 mm	ZKN	-	100 2500	
	30848	308487	M8x12x18 mm	ZKN	-	100 1000	
Blister	91570	915708	M6x10x13 mm	ZKN	4	- 10	
	91835	918358	M8x12x18 mm	ZKN	4	- 10	

Zamak

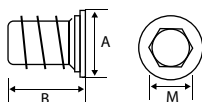

TUERCA EMBUTIR TRC4

	Código	8431488	Medida	Acabado			€uros
Caja	30831	308319	M6x11x11 mm	BL	-	250 2500	
Blister	90559	905594	M6x11x11 mm	BL	8	- 10	

Nylon

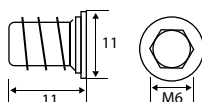

TUERCA EXPANSIBLE TRC6

	Código	8431488	Medida	Acabado			€uros
Caja	30833	308333	M6x12x8 mm	LT	-	200 5000	
Blister	90560	905600	M6x12x8 mm	LT	4	- 10	

Latón

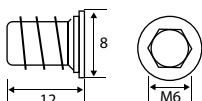



TUERCA ÉMBOLO TRC7



	Código	8431488	Medida	Acabado				€uros
Caja	30801	308012	M6x10x14 mm	NI	-	250	2500	
Blister	91720	917207	M6x10x14 mm	NI	8	-	10	

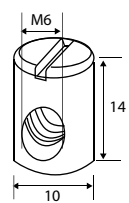

Tornillo Komby disponible en página 281

Acero
 NIQUEL

TUERCA PÚA EMBUTIR TRC2



	Código	8431488	Medida AxBxC	Acabado				€uros
Caja	30804	308043	M4x17x8	ZN	-	100	2500	
	30806	308067	M6x16x9,5	ZN	-	100	2500	
	30808	308081	M8x22x12	ZN	-	100	1000	
	30810	308104	M10x22x12	ZN	-	100	1000	
Blister	90552	905525	M4x17x8	ZN	4	-	10	
	90553	905532	M6x16x9,5	ZN	4	-	10	
	90554	905549	M8x22x12	ZN	4	-	10	
	90555	905556	M10x22x12	ZN	4	-	10	

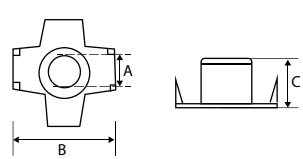

Acero
 ZINCADO

MEDIA LUNA MDL1

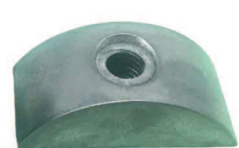

	Código	8431488	Medida	Acabado				€uros
Caja	30855	308555	M6x32 mm	ZKN	-	50	500	
	30856	308562	M8x32 mm	ZKN	-	50	500	
Blister	92330	923307	M6x32 mm	ZKN	4	-	10	
	92331	923314	M8x32 mm	ZKN	4	-	10	

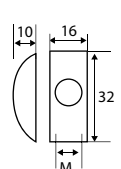

Zamak
 ZAMAK NATURAL

MEDIA LUNA MDL2



	Código	8431488	Medida	Acabado				€uros
Caja	30857	308579	6x28 mm	BL	-	100	1000	
Blister	92332	923321	6x28 mm	BL	4	-	10	

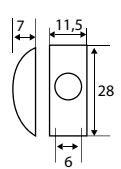

Nylon
 BLANCO

TORNILLO EURO TRN17

	Código	8431488	Medida	Acabado				€uros
Caja	30834	308340	6,3x7,7x10 mm	ZN	-	200	5000	
Blister	91688	916880	6,3x7,7x10 mm	ZN	12	-	10	

Acero

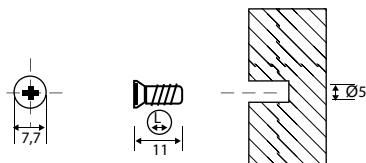

GRAPA TRASERA RECTANGULAR GRP1

	Código	8431488	Medida	Acabado				€uros
Caja	30800	308005	23x17 mm	ZN	-	1000	3000	
Blister	90582	905822	23x17 mm	ZN	10	-	10	

Acero

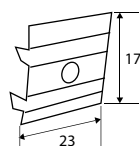

GRAPA TRASERA REDONDA GRP2

	Código	8431488	Medida	Acabado				€uros
Caja	30799	307992	15 mm	ZN	-	200	5000	
Blister	91326	913261	15 mm	ZN	10	-	10	

Acero

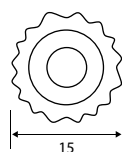

OVALILLO ARANDELA OV3

	Código	8431488	Medida A	Acabado				€uros
Caja	30795	307954	12 mm	LTD	-	1000	10000	
	30796	307961	14 mm	LTD	-	1000	10000	
	30797	307978	12 mm	NI	-	1000	10000	
	30798	307985	14 mm	NI	-	1000	10000	
Blister	91725	917252	12 mm	LTD	25	-	10	
	91726	917269	14 mm	LTD	25	-	10	
	91723	917238	12 mm	NI	25	-	10	
	91724	917245	14 mm	NI	25	-	10	

Acero

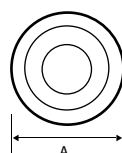



ÁNGULO TRASERA AN22

	Código	8431488	Medida	Acabado			€uros
Caja	61000	610009	19x19 mm	NI	-	100	1000
Blister	91568	915685	19x19 mm	NI	4	-	10

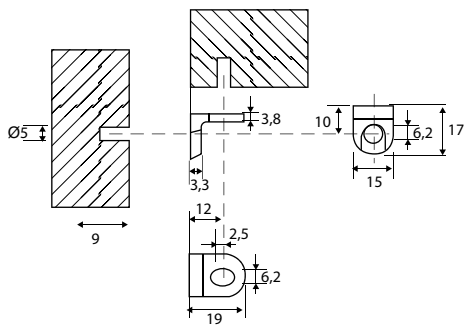

Zamak
 NIQUEL

ÁNGULO TRASERA C/TORNILLO AN21

	Código	8431488	Medida	Acabado			€uros
Caja	61003	610030	14x12 mm	NE	-	100	2500
Blister	91569	915692	14x12 mm	NE	4	-	10

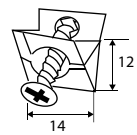

Nylon
 NEGRO

ÁNGULO C/TAPA AN20

	Código	8431488	Medida AxB	Acabado			€uros
Caja	61001	610016	18x20 mm	BL	-	200	2000
	61002	610023	42x20 mm	BL	-	100	1000
	61011	610115	18x20 mm	BE	-	200	2000
	61012	610122	42x20 mm	BE	-	100	1000
	61021	610214	18x20 mm	MA	-	200	2000
	61022	610221	42x20 mm	MA	-	100	1000
Blister	90450	904504	18x20 mm	BL	4	-	10
	90453	904535	42x20 mm	BL	4	-	10
	90451	904511	18x20 mm	BE	4	-	10
	90454	904542	42x20 mm	BE	4	-	10
	90452	904528	18x20 mm	MA	4	-	10
	90455	904559	42x20 mm	MA	4	-	10



Incluye tornillos en el blister

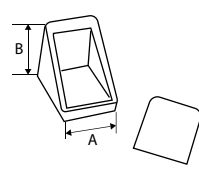

Plástico
 BLANCO
 BEIGE
 MARRÓN

TORNILLO ENSAMBLE TNE7

	Código	8431488	Medida	Acabado			€uros
Caja	30500	305004	78x28 mm	ZN	-	25	125

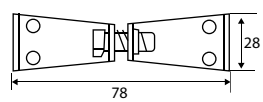
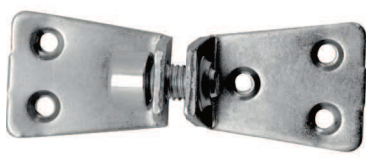

Acero
 ZINCADO

TORNILLO ENSAMBLE TNE6

	Código	8431488	Medida	Acabado				€uros
Caja	30502	305028	39x24 mm	BC	-	100	300	

Acero



BICROMATADO

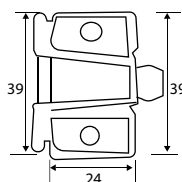

ENGANCHE STRONG ENG2

	Código	8431488	Medida	Acabado				€uros
Caja	30506	305066	38x21 mm	BL	-	50	500	
	30507	305073	38x21 mm	MA	-	50	500	

Plástico



BLANCO



MARRÓN

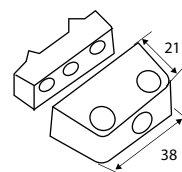

ENGANCHE STRONG ENG3

	Código	8431488	Medida	Acabado				€uros
Caja	30508	305080	38x21 mm	ZN	-	50	500	

Zamak



ZINCADO

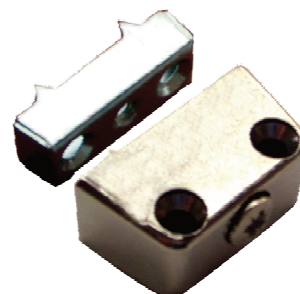
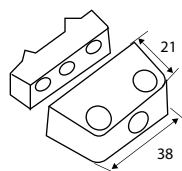

TORNILLO ENSAMBLE TNE1

	Código	8431488	Medida Ax B	Acabado				€uros
Caja	30202	302027	5x50 mm	ZN	-	1000	3000	
	30203	302034	7x50 mm	ZN	-	500	1500	
	30212	302126	5x50 mm	NE	-	1000	3000	
	30213	302133	7x50 mm	NE	-	500	1500	
Blister	90319	903194	5x50 mm	ZN	8	-	10	
	90320	903200	7x50 mm	ZN	8	-	10	
	90500	905006	5x50 mm	NE	8	-	10	
	90743	907437	7x50 mm	NE	8	-	10	

Acero



ZINCADO



NEGRO

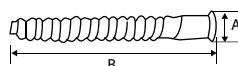

Tapón TPV5 disponible en página 262



TUERCA ENSAMBLE TNE9



	Código	8431488	Medida	Acabado				€uros
Caja	40001	400013	13x11x1/4 mm	LT	-	100	2500	
	40002	400020	13x11x1/4 mm	NI	-	100	2500	

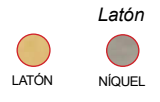
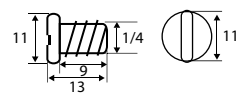

ESPÁRRAGO TNE10



	Código	8431488	Medida	Acabado				€uros
Caja	40030	400303	1/4x30 mm	ZN	-	100	2500	

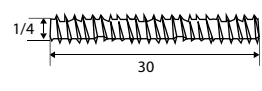

TUERCA ENSAMBLE TNE9 + ESPÁRRAGO TNE10

	Código	8431488	Medida	Acabado				€uros
Blister	90324	903248	1/4x30 mm	LT	4	-	10	
	90329	903293	1/4x30 mm	NI	4	-	10	



TORNILLO ENSAMBLE TNE8

	Código	8431488	Medida	Acabado				€uros
Caja	30312	303123	26-36 mm	BL	-	100	2000	
	30302	303024	34-44 mm	BL	-	100	500	
	30311	303116	26-36 mm	MA	-	100	2000	
	30301	303017	34-44 mm	MA	-	100	500	
Blister	90333	903330	26-36 mm	BL	4	-	10	
	90334	903347	34-44 mm	BL	4	-	10	
	90335	903354	26-36 mm	MA	4	-	10	
	90336	903361	34-44 mm	MA	4	-	10	



TORNILLO UNIÓN TNE11



	Código	8431488	Medida	Acabado				€uros
Caja	32624	326245	27 mm	NI	-	500	5000	
	32626	326269	31 mm	NI	-	500	5000	

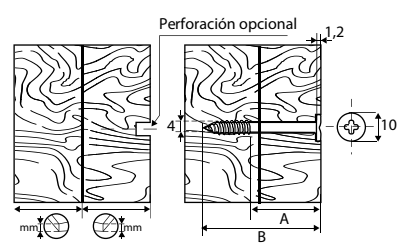

	A	B	mm
32624	16	27	15-16
32626	20	31	18-20

JGO TORNILLO UNIÓN KOMBY M4 TNE5

	Código	8431488	Medida	Acabado				€uros
Caja	32623	326238	M4x15x27 mm	NI	-	100	1000	
Blister	91728	917283	M4x15x27 mm	NI	4	-	10	

Acero

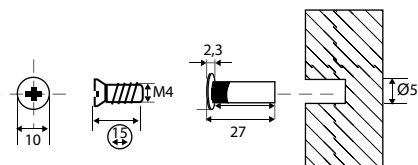

JGO TORNILLO UNIÓN KOMBY M6 TNE4

	Código	8431488	Medida	Acabado				€uros
Caja	00100	001005	M6x14x33 mm	LTD	-	100	500	
	00101	001012	M6x14x33 mm	NI	-	100	500	
Blister	90321	903217	M6x14x33 mm	LTD	4	-	10	
	90322	903224	M6x14x33 mm	NI	4	-	10	

Acero



TUBO UNIÓN KOMBY M6 TNE2

	Código	8431488	Medida	Acabado				€uros
Caja	31625	316253	8x29 mm	LTD	-	500	1500	
	32625	326252	8x29 mm	NI	-	500	1500	

Acero

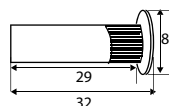

TORNILLO KOMBY M6 TNE3

	Código	8431488	Medida Ax B	Acabado				€uros
Caja	31615	316154	M6x15 mm	LTD	-	500	2500	
	32615	326153	M6x15 mm	NI	-	500	2500	
	32616	326160	M6x20 mm	NI	-	250	1250	
	32617	326177	M6x25 mm	NI	-	250	1250	
	32618	326184	M6x30 mm	NI	-	250	1250	
	32619	326191	M6x35 mm	NI	-	250	1250	
	32620	326207	M6x40 mm	NI	-	250	1250	
	32621	326214	M6x50 mm	NI	-	250	1250	
Blister	90593	905938	M6x15 mm	NI	12	-	10	
	90594	905945	M6x20 mm	NI	12	-	10	
	90595	905952	M6x25 mm	NI	10	-	10	
	90596	905969	M6x30 mm	NI	10	-	10	
	90597	905976	M6x35 mm	NI	10	-	10	
	90598	905983	M6x40 mm	NI	8	-	10	
	90599	905990	M6x50 mm	NI	8	-	10	
	90600	906003	M6x60 mm	NI	6	-	10	

Acero

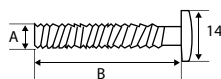



TORNILLO CASCABEL TRN15

	Código	843 I 488	Medida Ax B	Acabado			€uros
Caja	00438	004389	9x40 mm	BC	-	25	250
	00439	004396	9x60 mm	BC	-	25	250
	00440	004402	9x80 mm	BC	-	25	250
	00441	004419	9x100 mm	BC	-	25	250
	00476	004761	9x120 mm	BC	-	25	1250
	00477	004778	9x140 mm	BC	-	25	1250
Blister	92110	921105	9x40 mm	BC	2	-	10
	92111	921112	9x60 mm	BC	2	-	10
	92112	921129	9x80 mm	BC	2	-	10
	92113	921136	9x100 mm	BC	2	-	10

Incluye tuerca y arandela

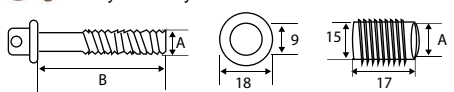

Acero



TORNILLO ANCLAJE TRN6

	Código	843 I 488	Medida	Acabado			€uros
Caja	44830	448305	M6x30 mm	BC	-	1000	3000
Blister	90206	902067	M6x30 mm	BC	10	-	10

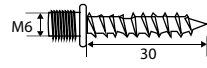

Acero



TORNILLO DOWELL TRN9

	Código	843 I 488	Medida Ax B	Acabado			€uros
Caja	00420	004204	M4x20 mm	ZN	-	1000	10000
	00421	004211	M4x30 mm	ZN	-	500	5000
	00422	004228	M6x40 mm	ZN	-	100	1000
	00423	004235	M6x60 mm	ZN	-	100	1000
	00670	006703	M6x70 mm	ZN	-	100	1000
	00425	004259	M8x60 mm	ZN	-	100	1000
	00426	004266	M8x70 mm	ZN	-	100	1000
	00427	004273	M8x80 mm	ZN	-	100	500
	00428	004280	M8x100 mm	ZN	-	100	500
	00429	004297	M10x50 mm	ZN	-	50	500
	00430	004303	M10x60 mm	ZN	-	50	500
	00431	004310	M10x90 mm	ZN	-	50	500
	00432	004327	M10x100 mm	ZN	-	50	250
Blister	90207	902074	M4x20 mm	ZN	8	-	10
	91989	919898	M4x30 mm	ZN	8	-	10
	91990	919904	M6x40 mm	ZN	4	-	10
	91991	919911	M6x60 mm	ZN	4	-	10
	90208	902081	M6x70 mm	ZN	4	-	10
	91993	919935	M8x60 mm	ZN	2	-	10
	91994	919942	M8x70 mm	ZN	2	-	10
	91995	919959	M8x80 mm	ZN	2	-	10
	91996	919966	M8x100 mm	ZN	2	-	10
	91997	919973	M10x50 mm	ZN	2	-	10
91998	919980	M10x60 mm	ZN	2	-	10	
91999	919997	M10x90 mm	ZN	2	-	10	
92100	921006	M10x100 mm	ZN	2	-	10	

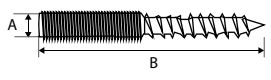

Acero



ESPÁRRAGO ROSCA MADERA TRN13

	Código	8431488	Medida AxB	Acabado				€uros
Caja	00433	004334	8x60 mm	ZN	-	100	1000	
	00434	004341	8x70 mm	ZN	-	100	1000	
	00435	004358	8x75 mm	ZN	-	100	500	
Blister	92118	921181	8x60 mm	ZN	2	-	10	
	92119	921198	8x70 mm	ZN	2	-	10	
	92120	921204	8x75 mm	ZN	2	-	10	

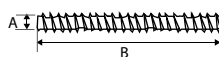

ESPÁRRAGO 2 ROSCAS TRN14

	Código	8431488	Medida	Acabado				€uros
Caja	00436	004365	4x40 mm	ZN	-	100	2500	
Blister	92101	921013	4x40 mm	ZN	4	-	10	

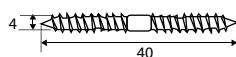

TORNILLO SILLA TRN10

	Código	8431488	Medida AxB	Acabado				€uros
Caja	43158	431581	3/16x15 mm	NI	-	100	2500	
	43159	431598	3/16x20 mm	NI	-	100	2500	
	43160	431604	3/16x25 mm	NI	-	100	2500	
	43161	431611	3/16x30 mm	NI	-	100	2500	
	43162	431628	3/16x35 mm	NI	-	100	2500	
	43163	431635	3/16x40 mm	NI	-	100	2500	
	43164	431642	3/16x45 mm	NI	-	100	2500	
	43165	431659	3/16x50 mm	NI	-	100	1000	
	43166	431666	3/16x60 mm	NI	-	50	1250	
	43167	431673	3/16x70 mm	NI	-	50	1250	



No incluye tuerca

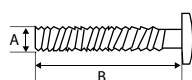

TUERCA SILLA TRC8

	Código	8431488	Medida	Acabado				€uros
Caja	30316	30316	3/16	NI	-	100	2500	

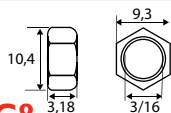

TORNILLO TRN10 + TUERCA SILLA TRC8

	Código	8431488	Medida AxB	Acabado				€uros
Blister	92153	921532	3/16x15 mm	NI	4	-	10	
	92154	921549	3/16x20 mm	NI	4	-	10	
	92155	921556	3/16x25 mm	NI	4	-	10	
	92156	921563	3/16x30 mm	NI	4	-	10	
	92157	921570	3/16x35 mm	NI	4	-	10	
	92158	921587	3/16x40 mm	NI	4	-	10	
	92159	921594	3/16x45 mm	NI	4	-	10	
	90205	902050	3/16x50 mm	NI	4	-	10	
	92160	921600	3/16x60 mm	NI	4	-	10	
	92161	921617	3/16x70 mm	NI	4	-	10	





UNIÓN PANELES ENS3 Y ENS4

	Código	8431488	Montaje	Acabado				€uros
Caja	30515	305158	sobrepuesto	NE	-	50	500	
	30514	305141	suspendido	NE	-	50	500	

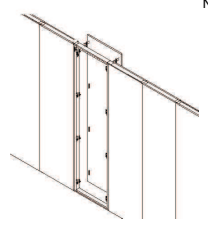
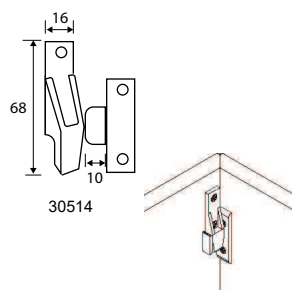
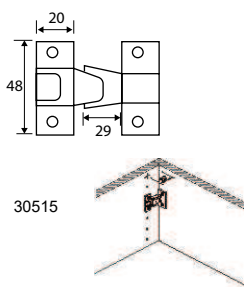

Nylon
 NEGRO

ENSAMBLE ENCIMERA ENS1

	Código	8431488	Medida	Acabado			€uros
Caja	30846	308463	M8x48 mm	BL	-	25	250

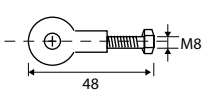

Zamak
 BLANCO

ENSAMBLE ENCIMERA ENS2

	Código	8431488	Medida	Acabado			€uros
Caja	30847	308470	M6x150 mm	ZN	-	25	1250

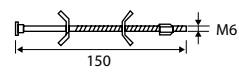

Acero
 ZINCADO

GALLETA MADERA ENS9

	Código	8431488	Tipo/Medida AxB	Acabado			€uros
Caja	41018	410180	nº 0 - 48x15 mm	HAYA	-	1000	-
	41019	410197	nº 10 - 55x20 mm	HAYA	-	1000	-
	41020	410203	nº 20 - 60x25 mm	HAYA	-	1000	-
Blister	91506	915067	nº 0 - 48x15 mm	HAYA	20	-	10
	91507	915074	nº 10 - 55x20 mm	HAYA	20	-	10
	90344	903446	nº 20 - 60x25 mm	HAYA	20	-	10

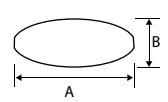

Madera
 HAYA

ESPIGA METÁLICA ENS8

	Código	8431488	Medida	Acabado			€uros
Caja	41021	410210	9,3x37 mm	ZN/VE	-	100	1000

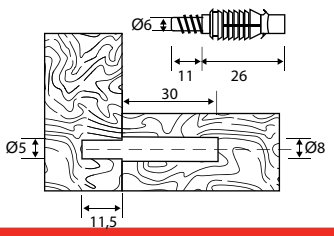

Acero/PVC
 ZINCADO/VERDE

ESPIGA MADERA ENS5

	Código	8431488	Medida AxB	Acabado				€uros
Caja	46300	463001	6x30 mm	HAYA	-	100	10000	
	46350	463506	6x35 mm	HAYA	-	100	10000	
	46400	464008	6x40 mm	HAYA	-	100	10000	
	48300	483009	8x30 mm	HAYA	-	100	5000	
	48350	483504	8x35 mm	HAYA	-	100	5000	
	48400	484006	8x40 mm	HAYA	-	100	5000	
	41035	410357	10x35 mm	HAYA	-	100	5000	
	41040	410401	10x40 mm	HAYA	-	100	5000	
	41240	412405	12x40 mm	HAYA	-	100	2500	
	41440	414409	14x60 mm	HAYA	-	100	2500	
Blister	90341	903415	6x30 mm	HAYA	25	-	10	
	90342	903422	8x40 mm	HAYA	25	-	10	
	90343	903439	10x40 mm	HAYA	20	-	10	

Haya



VARILLA MADERA ESTRIADA ENS6

	Código	8431488	Medida AxB	Acabado				€uros
	41060	410609	6x1 mt	HAYA	-	10	-	
	41080	410807	8x1 mt	HAYA	-	10	-	
	41100	411002	10x1 mt	HAYA	-	10	-	
	41120	411200	12x1 mt	HAYA	-	10	-	
	41140	411408	14x1 mt	HAYA	-	10	-	
	41160	411606	16x1 mt	HAYA	-	10	-	
	41142	411422	18x1 mt	HAYA	-	10	-	
	41143	411439	20x1 mt	HAYA	-	10	-	

Haya



Etiquetado individualmente

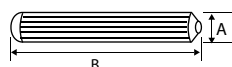

VARILLA MADERA LISA ENS7

	Código	8431488	Medida AxB	Acabado				€uros
	41141	411415	5x0,8 mts	HAYA	-	10	-	
	41161	411613	6x1 mt	HAYA	-	10	-	
	41162	411620	8x1 mt	HAYA	-	10	-	
	41163	411637	10x1 mt	HAYA	-	10	-	
	41164	411644	12x1 mt	HAYA	-	10	-	
	41165	411651	14x1 mt	HAYA	-	10	-	
	41166	411668	16x1 mt	HAYA	-	10	-	
	41167	411675	18x1 mt	HAYA	-	10	-	
	41168	411682	20x1 mt	HAYA	-	10	-	
	41169	411699	25x1 mt	HAYA	-	10	-	

Haya



Etiquetado individualmente

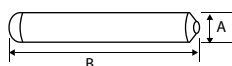



DESILZANTE CLAVO DZ1

	Código	8431488	Medida A	Acabado				€uros
Caja	60511	605111	15 mm	BL	-	1000	10000	
	60503	605036	15 mm	BL	-	100	5000	
	60512	605128	15 mm	MA	-	1000	10000	
	60504	605043	15 mm	MA	-	100	5000	
	60521	605210	17 mm	BL	-	1000	10000	
	60505	605050	17 mm	BL	-	100	5000	
	60522	605227	17 mm	MA	-	1000	10000	
Blister	90374	903743	15 mm	BL	4	-	10	
	90375	903750	17 mm	BL	4	-	10	
	90377	903774	15 mm	MA	4	-	10	
	90378	903781	17 mm	MA	4	-	10	



Polipropileno



DESILZANTE FIELTRO DZ2

	Código	8431488	Medida A	Acabado				€uros
Caja	60536	605364	17 mm	MA	-	500	5000	
	60537	605371	20 mm	MA	-	500	5000	
	60538	605388	25 mm	MA	-	250	2500	
	60539	605395	30 mm	MA	-	200	2000	
Blister	90588	905884	17 mm	MA	4	-	10	
	90589	905891	20 mm	MA	4	-	10	
	90590	905907	25 mm	MA	4	-	10	
	90591	905914	30 mm	MA	4	-	10	



Fieltro



DESILZANTE METÁLICO DZ3

	Código	8431488	Medida A	Acabado				€uros
Caja	60531	605319	15 mm	NI	-	100	1000	
	60532	605326	18 mm	NI	-	100	1000	
	60533	605333	20 mm	NI	-	100	1000	
	60534	605340	23 mm	NI	-	100	500	
	60535	605357	26 mm	NI	-	100	500	
Blister	90583	905839	15 mm	NI	4	-	10	
	90584	905846	18 mm	NI	4	-	10	
	90585	905853	20 mm	NI	4	-	10	
	90586	905860	23 mm	NI	4	-	10	
	90587	905877	26 mm	NI	4	-	10	



Acero



DESILZANTE CLAVO SD DZ4

	Código	8431488	Medida A	Acabado				€uros
Caja	60546	605463	20 mm	GR	-	50	500	
	60547	605470	25 mm	GR	-	50	500	
	60548	605487	30 mm	GR	-	50	500	
Blister	91455	914558	20 mm	GR	4	-	10	
	91456	914565	25 mm	GR	4	-	10	
	91457	914572	30 mm	GR	4	-	10	



Polietileno



DESLIZANTE ADHESIVO SD DZ5

	Código	8431488	Medida AxB	Acabado			€uros
Caja	60540	605401	20 mm	GR	-	50	1250
	60541	605418	25 mm	GR	-	50	1250
	60542	605425	30 mm	GR	-	50	1250
	60543	605432	24x24 mm	GR	-	50	1250
	60544	605449	30x30 mm	GR	-	50	500
Blister	91408	914084	20 mm	GR	4	-	10
	91409	914091	25 mm	GR	4	-	10
	91410	914107	30 mm	GR	4	-	10
	91411	914114	24x24 mm	GR	4	-	10
	91412	914121	30x30 mm	GR	4	-	10
	91553	915531	24x100 mm	GR	4	-	10

Polietileno



GRIS

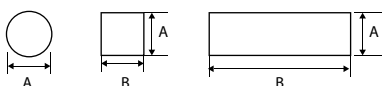

DESLIZANTE ATORNILLAR SD DZ6

	Código	8431488	Medida A	Acabado			€uros
Caja	60525	605258	19 mm	GR	-	50	1250
	60526	605265	25 mm	GR	-	50	500
	60527	605272	30 mm	GR	-	50	500
	60528	605289	38 mm	GR	-	25	250
Blister	92366	923666	19 mm	GR	4	-	10
	92367	923673	25 mm	GR	4	-	10
	92368	923680	30 mm	GR	4	-	10
	92369	923697	38 mm	GR	4	-	10

Polietileno



GRIS

Incluye tornillo



DESLIZANTE ATORNILLAR GOMA DZ10

	Código	8431488	Medida	Acabado			€uros
Caja	60523	605234	20 mm	TR	-	100	1000
	60524	605241	25 mm	TR	-	100	500
Blister	92313	923130	20 mm	TR	4	-	10
	92314	923147	25 mm	TR	4	-	10

Goma



TRANSPARENTE

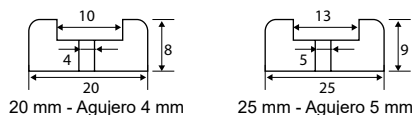

20 mm - Agujero 4 mm

25 mm - Agujero 5 mm



CUÑA NIVELADORA NV11 / NV14

	Código	8431488	Medida AxBxC	Acabado			€uros
Caja	43511	435114	60x30x7 mm	TR	-	100	1000
	43510	435107	100x20x8 mm	MA	-	100	1000
Blister	92312	923123	60x30x7 mm	TR	2	-	10
	90198	901985	100x20x8 mm	MA	4	-	10

43511: Poliestireno

43510: Goma

43510: Autocortable



TRANSPARENTE



MARRÓN

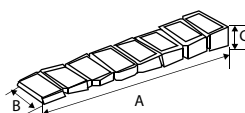

NV14 - 43511



NV11 - 43510



FIELTRO ADHESIVO DZ7



	Código	8431488	Medida A	Acabado			€uros
Caja	60549	605494	16 mm	MA	-	1000	10000
	60550	605500	20 mm	MA	-	1000	10000
	60551	605517	22 mm	MA	-	800	8000
	60552	605524	26 mm	MA	-	600	6000
	60553	605531	28 mm	MA	-	450	4500
	60554	605548	34 mm	MA	-	300	3000
	60555	605555	16 mm	BL	-	1000	10000
	60556	605562	20 mm	BL	-	1000	10000
	60557	605579	22 mm	BL	-	800	8000
	60558	605586	26 mm	BL	-	600	6000
	60559	605593	28 mm	BL	-	450	4500
	60560	605609	34 mm	BL	-	300	3000
Blister	91389	913896	16 mm	MA	20	-	10
	91395	913957	20 mm	MA	15	-	10
	91390	913902	22 mm	MA	15	-	10
	91391	913919	26 mm	MA	6	-	10
	91554	915548	28 mm	MA	6	-	10
	91392	913926	34 mm	MA	4	-	10
	91396	913964	16 mm	BL	20	-	10
	91402	914022	20 mm	BL	15	-	10
	91397	913971	22 mm	BL	15	-	10
	91398	913988	26 mm	BL	6	-	10
	91559	915593	28 mm	BL	6	-	10
	91399	913995	34 mm	BL	4	-	10

Esesor 3 mm



Fieltro
 BLANCO
 MARRÓN

FIELTRO ADHESIVO DZ9 (ROLLO)



	Código	8431488	Medida AxB	Acabado			€uros
Caja	60575	605753	85x1 mt	MA	-	5	50
	60576	605760	85x1 mt	BL	-	5	50
Blister	92171	921716	85x1 mt	MA	1	-	10
	92172	921723	85x1 mt	BL	1	-	10

Esesor 3 mm



Fieltro
 MARRÓN
 BLANCO

FIELTRO ADHESIVO DZ8

	Código	8431488	Medida AxB	Acabado			€uros
Caja	60561	605616	17x17 mm	MA	-	1000	10000
	60562	605623	22x22 mm	MA	-	800	8000
	60563	605630	25x25 mm	MA	-	600	6000
	60564	605647	30x30 mm	MA	-	450	4500
	60565	605654	100x100 mm	MA	-	50	500
	60566	605661	50x100 mm	MA	-	100	1000
	60573	605739	85x100 mm	MA	-	50	500
	60567	605678	17x17 mm	BL	-	1000	10000
	60568	605685	22x22 mm	BL	-	800	8000
	60569	605692	25x25 mm	BL	-	600	6000
	60570	605708	30x30 mm	BL	-	450	4500
	60571	605715	100x100 mm	BL	-	50	500
	60572	605722	50x100 mm	BL	-	100	1000
	60574	605746	85x100 mm	BL	-	50	500
Blister	91393	913933	17x17 mm	MA	20	-	10
	91394	913940	22x22 mm	MA	12	-	10
	91555	915555	25x25 mm	MA	6	-	10
	91556	915562	30x30 mm	MA	6	-	10
	91558	915586	50x100 mm	MA	2	-	10
	91557	915579	85x100 mm	MA	1	-	10
	91400	914008	17x17 mm	BL	20	-	10
	91401	914015	22x22 mm	BL	12	-	10
	91560	915609	25x25 mm	BL	6	-	10
	91561	915616	30x30 mm	BL	6	-	10
	91563	915630	50x100 mm	BL	2	-	10
	91562	915623	85x100 mm	BL	1	-	10

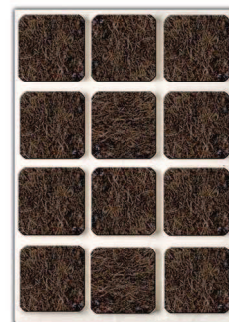

Fieltro

Espesor 3 mm



PIVOTE CENTRADOR MESA ESM3

	Código	8431488	Medida AxB	Acabado			€uros
Caja	30516	305165	8x18 mm	LTD	-	100	2500
	30517	305172	10x22 mm	LTD	-	100	1000



Acero

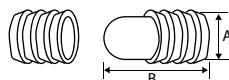

LATONADO

ESCUADRA MESA ESM1

	Código	8431488	Medida	Acabado			€uros
Caja	30521	305219	60x34x34 mm	ZN	-	4	40



Acero

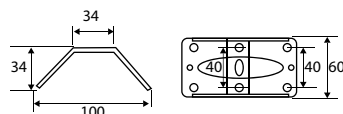

ZINCADO

ESCUADRA MESA ESM2

	Código	8431488	Medida	Acabado			€uros
Caja	30522	305226	60x38x60 mm	ZN	-	4	40

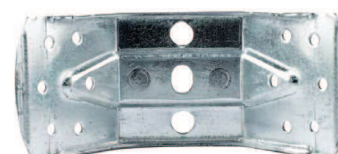

Acero

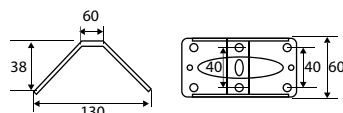

ZINCADO



CIERRE CAJA CC1

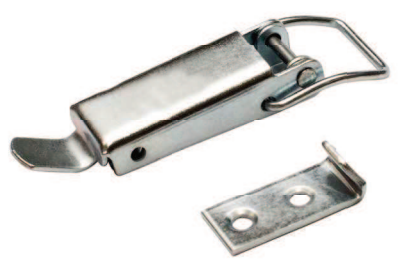

	Código	8431488	Medida	Acabado			€uros
Caja	30511	305110	75x23 mm	ZN	-	50	250
	30527	305271	100x34 mm	ZN	-	10	100
	30525	305257	131x43 mm	ZN	-	5	25
Blister	90291	902913	75x23 mm	ZN	1	-	10
	91975	919751	100x34 mm	ZN	1	-	10
	91973	919737	131x43 mm	ZN	1	-	10

Incluye tornillos en el blister

Acero

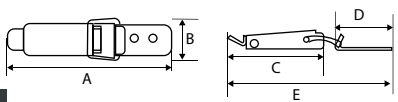

código	A	B	C	D	E	tensión máx.
30511	75 mm	23 mm	60 mm	30 mm	102 mm	130 Kgs
30527	100 mm	34 mm	86 mm	43 mm	140,5 mm	300 Kgs
30525	131 mm	43 mm	111,5 mm	66 mm	193,5 mm	400 Kgs

CIERRE CAJA CANDADO CC1



	Código	8431488	Medida	Acabado			€uros
Caja	30510	305103	75x23 mm	ZN	-	50	250
	30528	305288	100x34 mm	ZN	-	10	100
	30526	305264	131x43 mm	ZN	-	5	25
Blister	90289	902890	75x23 mm	ZN	1	-	10
	91976	919768	100x34 mm	ZN	1	-	10
	91974	919744	131x43 mm	ZN	1	-	10

Incluye tornillos en el blister

Acero

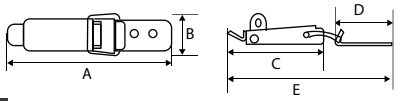

código	A	B	C	D	E	tensión máx.
30510	75 mm	23 mm	60 mm	30 mm	102 mm	130 Kgs
30528	100 mm	34 mm	86 mm	43 mm	140,5 mm	300 Kgs
30526	131 mm	43 mm	111,5 mm	66 mm	193,5 mm	400 Kgs

CIERRE CAJA CC2



	Código	8431488	Medida	Acabado			€uros
Caja	30529	305295	42x23 mm	ZN	-	25	250
Blister	91977	919775	42x23 mm	ZN	1	-	10

Incluye tornillos en el blister

Acero

Tensión máxima 150 Kgs

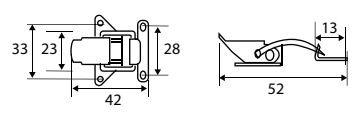

CIERRE CAJA CANDADO CC2



	Código	8431488	Medida	Acabado			€uros
Caja	30530	305301	42x23 mm	ZN	-	25	250
Blister	91978	919782	42x23 mm	ZN	1	-	10

Incluye tornillos en el blister

Acero

Tensión máxima 150 Kgs

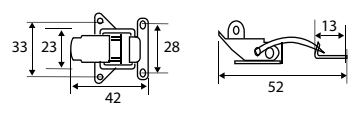

CIERRE CAJA CC3

	Código	8431488	Medida	Acabado				€uros
Caja	30512	305127	53x23 mm	ZN	-	50	250	
Blister	90290	902906	53x23 mm	ZN	1	-	10	

Acero

ZINCADO

Incluye tornillos en el blister
▲ Tensión máxima 100 Kgs

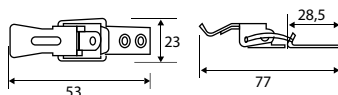

CIERRE CAJA CC4

	Código	8431488	Medida	Acabado				€uros
Caja	30531	305318	50x22 mm	ZN	-	25	250	
Blister	91979	919799	50x22 mm	ZN	1	-	10	

Acero

ZINCADO

Incluye tornillos en el blister
▲ Tensión máxima 100 Kgs

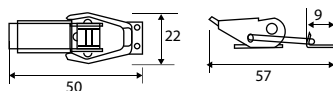

CIERRE CAJA CC5

	Código	8431488	Medida	Acabado				€uros
Caja	30532	305325	70x28 mm	ZN	-	25	125	
Blister	91980	919805	70x28 mm	ZN	1	-	10	

Acero

ZINCADO

Incluye tornillos en el blister
▲ Tensión máxima 250 Kgs

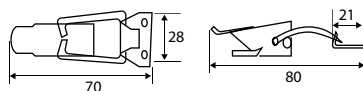

CIERRE CAJA REGULABLE CC6

	Código	8431488	Medida	Acabado				€uros
Caja	30533	305332	138-150 mm	ZN	-	5	50	
Blister	91981	919812	138-150 mm	ZN	1	-	10	

Acero

ZINCADO

Incluye tornillos en el blister
▲ Tensión máxima 250 Kgs

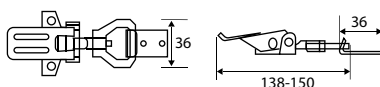

CIERRE CAJA C/LLAVE CC7

	Código	8431488	Medida	Acabado				€uros
Caja	30534	305349	131x43 mm	NE	-	5	25	
Blister	92164	921648	131x43 mm	NE	1	-	10	

Acero

NEGRO

Incluye tornillos en el blister
▲ Tensión máxima 400 Kgs

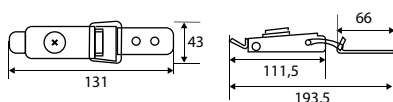



TORNILLO CAMA TRN12



	Código	8431488	Medida AxB	Acabado				€uros
Caja	00442	004426	9x60 mm	BC	-	25	250	
	00443	004433	9x80 mm	BC	-	25	250	
	00444	004440	9x100 mm	BC	-	25	250	
	00475	004754	9x140 mm	BC	-	25	125	
Blister	92114	921143	9x60 mm	BC	2	-	10	
	92115	921150	9x80 mm	BC	2	-	10	
	92116	921167	9x100 mm	BC	2	-	10	

Incluye tuerca y arandela

Acero

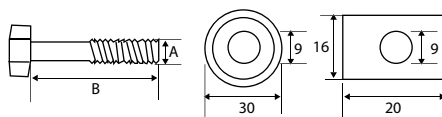

TUERCA RECTANGULAR TRC10

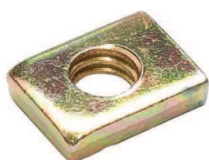

	Código	8431488	Medida	Acabado				€uros
Caja	00445	004457	9x16 mm	BC	-	25	250	
Blister	92117	921174	9x16 mm	BC	6	-	10	

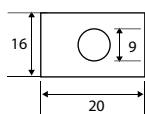

Acero



ENGANCHE LARGUERO CAMA SMR4



	Código	8431488	Medida	Acabado				€uros
Caja	96423	964232	80 mm	ZN	-	4	40	

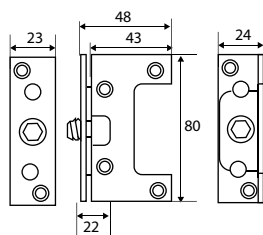

Acero



JGO ENGANCHE CAMA SMR3

	Código	8431488	Medida	Acabado				€uros
Caja	96415	964157	95x23 mm	ZN	-	10	30	

1 juego = 8 piezas

Acero

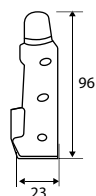

SOPORTE SOMIER SMR1

	Código	8431488	Medida	Acabado			€uros
Caja	96414	964140	55x50 mm	ZN	-	50	250

Acero

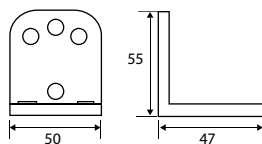

SOPORTE LARGUERO CAMA SMR2

	Código	8431488	Medida A	Acabado			€uros
Caja	96420	964201	40 mm	ZN	-	8	80
	96421	964218	50 mm	ZN	-	8	80

Acero

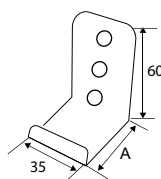

ESCUADRA BAÑERA CAMA SMR5

	Código	8431488	Medida	Acabado			€uros
Caja	96419	964195	310x76 mm	GV	-	4	32

Acero

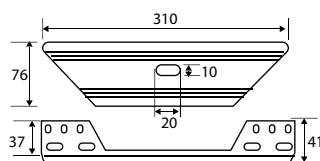

SOPORTE ESCALERA LITERA SMR6

	Código	8431488	Medida	Acabado			€uros
Caja	96422	964225	71x20 mm	ZN	-	10	250

Acero

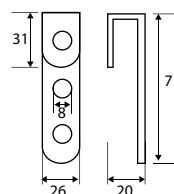



VARILLA HUECA P/LÁMPARAS VR1

	Código	843 I 488	Medida A	Acabado				€uros
Caja	40061	400617	M10/100x20 mm	ZN	-	100	1000	
	40062	400624	M10/100x40 mm	ZN	-	100	1000	
	40063	400631	M10/100x100 mm	ZN	-	50	250	
	40064	400648	M10/100x1 mt	ZN	-	5	-	

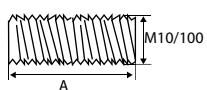

Acero
 ZINCADO

TUERCA P/VARILLA HUECA TRC9

	Código	843 I 488	Medida Ax B	Acabado				€uros
Caja	40065	400655	M10/100x13x4 mm	ZN	-	100	2500	
Blister	91986	919867	M10/100x13x4 mm	ZN	4	-	10	

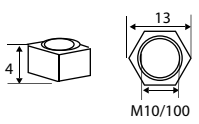

Acero
 ZINCADO

VARILLA HUECA VR1 + TUERCA TRC9

	Código	843 I 488	Medida Ax B	Acabado				€uros
Blister	91983	919836	M10/100x20 mm	ZN	2	-	10	
	91984	919843	M10/100x40 mm	ZN	2	-	10	
	91985	919850	M10/100x100 mm	ZN	2	-	10	



Acero
 ZINCADO

TUERCA CIEGA TRC1

	Código	843 I 488	Medida MxAxB	Acabado				€uros
Caja	49041	490410	M4x7x6,5 mm	LT	-	250	6250	
	49042	490427	M4x7x6,5 mm	NI	-	250	6250	
	49051	490519	M5x8x7 mm	LT	-	250	6250	
	49052	490526	M5x8x7 mm	NI	-	250	6250	
	49061	490618	M6x10x8 mm	LT	-	250	6250	
	49062	490625	M6x10x8 mm	NI	-	250	6250	
	49081	490816	M8x12x10 mm	LT	-	250	2500	
	49082	490823	M8x12x10 mm	NI	-	250	2500	
	49101	491011	M10x13x12 mm	LT	-	250	2500	
	49102	491028	M10x13x12 mm	NI	-	250	2500	
Blister	90220	902203	M4x7x6,5 mm	LT	10	-	10	
	90221	902210	M4x7x6,5 mm	NI	10	-	10	
	90222	902227	M5x8x7 mm	LT	10	-	10	
	90223	902234	M5x8x7 mm	NI	10	-	10	
	90224	902241	M6x10x8 mm	LT	10	-	10	
	90225	902258	M6x10x8 mm	NI	10	-	10	
	90228	902289	M8x12x10 mm	LT	8	-	10	
	90229	902296	M8x12x10 mm	NI	8	-	10	
	90230	902302	M10x13x12 mm	LT	8	-	10	
	90231	902319	M10x13x12 mm	NI	8	-	10	

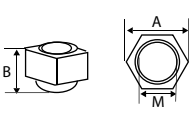

Latón
 NIQUEL LATÓN



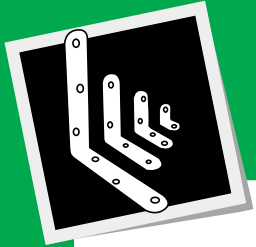

EMBELLECEDOR LISO SC1



	Código	8431488	Medida A	Acabado				€uros
Caja	45121	451213	12 mm	LT	-	100	1000	
	45141	451411	14 mm	LT	-	100	1000	
	45161	451619	16 mm	LT	-	100	1000	
	45181	451817	18 mm	LT	-	100	1000	
	45122	451220	12 mm	NI	-	100	1000	
	45142	451428	14 mm	NI	-	100	1000	
	45162	451626	16 mm	NI	-	100	1000	
	45182	451824	18 mm	NI	-	100	1000	
Blister	90380	903804	12 mm	LT	4	-	10	
	90381	903811	14 mm	LT	4	-	10	
	90382	903828	16 mm	LT	4	-	10	
	90383	903835	18 mm	LT	4	-	10	
	90384	903842	12 mm	NI	4	-	10	
	90385	903859	14 mm	NI	4	-	10	
	90386	903866	16 mm	NI	4	-	10	
	90387	903873	18 mm	NI	4	-	10	

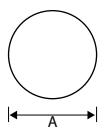

Latón
 LATÓN
 NIQUEL

EMBELLECEDOR FACETADO SC2



	Código	8431488	Medida A	Acabado				€uros
Caja	46121	461212	12 mm	LT	-	100	1000	
	46141	461410	14 mm	LT	-	100	1000	
	46161	461618	16 mm	LT	-	100	1000	
	46181	461816	18 mm	LT	-	100	1000	
	46122	461229	12 mm	NI	-	100	1000	
	46142	461427	14 mm	NI	-	100	1000	
	46162	461625	16 mm	NI	-	100	1000	
	46182	461823	18 mm	NI	-	100	1000	
Blister	90388	903880	12 mm	LT	4	-	10	
	90389	903897	14 mm	LT	4	-	10	
	90390	903903	16 mm	LT	4	-	10	
	90391	903910	18 mm	LT	4	-	10	
	90392	903927	12 mm	NI	4	-	10	
	90393	903934	14 mm	NI	4	-	10	
	90394	903941	16 mm	NI	4	-	10	
	90395	903958	18 mm	NI	4	-	10	

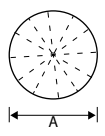

Latón
 LATÓN
 NIQUEL

SUJETALUNAS SC3

	Código	8431488	Medida	Acabado				€uros
Caja	47011	470115	2-6 mm	latón liso	-	100	1000	
	47111	471112	5-8 mm	latón liso	-	100	500	
	47012	470122	2-6 mm	níquel liso	-	100	1000	
	47112	471129	5-8 mm	níquel liso	-	100	500	
	48011	480114	2-6 mm	latón facetado	-	100	1000	
	48111	481111	5-8 mm	latón facetado	-	100	500	
	48012	480121	2-6 mm	níquel facetado	-	100	1000	
	48112	481128	5-8 mm	níquel facetado	-	100	500	
Blister	90396	903965	2-6 mm	latón liso	4	-	10	
	90397	903972	5-8 mm	latón liso	4	-	10	
	90398	903989	2-6 mm	níquel liso	4	-	10	
	90399	903996	5-8 mm	níquel liso	4	-	10	
	90400	904009	2-6 mm	latón facetado	4	-	10	
	90401	904016	5-8 mm	latón facetado	4	-	10	
	90402	904023	2-6 mm	níquel facetado	4	-	10	
	90403	904030	5-8 mm	níquel facetado	4	-	10	



Latón

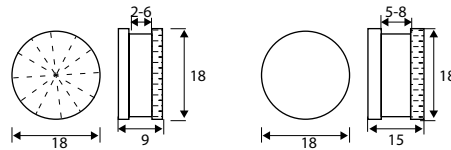

SEPARADOR CRISTAL SC8

	Código	8431488	Medida AxBxC	Acabado				€uros
Caja	32516	325163	12x25x20 mm	INOX	-	4	24	
	32517	325170	15x50x45 mm	INOX	-	4	24	
	32518	325187	18x75x65 mm	INOX	-	4	24	
	32519	325194	20x100x95 mm	INOX	-	4	24	

Acero Inoxidable

Válido para cristal máx. 10 mm

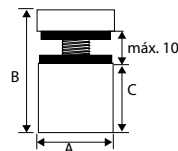

JGO SOPORTE ESPEJOS SC7

	Código	8431488	Medida	Acabado				€uros
Blister	30513	305134	45x25 mm	ZN	1	-	25	

Acero

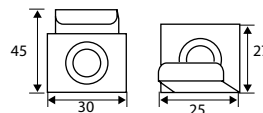

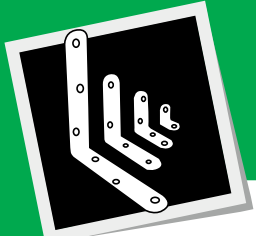

SOPORTE CILÍNDRICO SC4

	Código	8431488	Medida	Acabado			€uros
Caja	32701	327013	5-6 mm	OR	-	50	250
	32702	327020	5-6 mm	CB	-	50	250
	32703	327037	5-6 mm	CM	-	50	250
	32704	327044	5-6 mm	BL	-	50	250
	32712	327129	8-10 mm	CB	-	50	250
	32713	327136	8-10 mm	CM	-	50	250
Blister	90404	904047	5-6 mm	OR	2	-	10
	90405	904054	5-6 mm	CB	2	-	10
	90406	904061	5-6 mm	CM	2	-	10
	90407	904078	5-6 mm	BL	2	-	10
	90410	904108	8-10 mm	CB	2	-	10
	90411	904115	8-10 mm	CM	2	-	10

Incluye tornillo y tapón de plástico

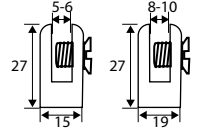

Zamak

ORO
 CROMO BRILLO
 CROMO MATE
 BLANCO

SOPORTE ESFÉRICO SC5



	Código	8431488	Medida A	Acabado			€uros
Caja	32601	326016	5-6 mm	OR	-	25	125
	32602	326023	5-6 mm	CB	-	25	125
	32603	326030	5-6 mm	CM	-	25	125
	32604	326047	5-6 mm	BL	-	25	125
	32605	326054	5-6 mm	NE	-	25	125

Incluye tornillo y tapón de plástico

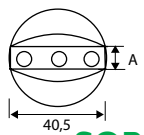

Zamak

ORO
 CROMO BRILLO
 CROMO MATE
 BLANCO
 NEGRO

SOPORTE MEDIA LUNA SC6



	Código	8431488	Medida A	Acabado			€uros
Caja	32501	325019	5-6 mm	OR	-	50	150
	32502	325026	5-6 mm	CB	-	50	150
	32503	325033	5-6 mm	CM	-	50	150
	32504	325040	5-6 mm	BL	-	50	150
	32511	325118	8-10 mm	OR	-	50	150
	32512	325125	8-10 mm	CB	-	50	150
	32513	325132	8-10 mm	CM	-	50	150
	32514	325149	8-10 mm	BL	-	50	150
Blister	90419	904191	5-6 mm	OR	2	-	10
	90420	904207	5-6 mm	CB	2	-	10
	90421	904214	5-6 mm	CM	2	-	10
	90422	904221	5-6 mm	BL	2	-	10
	90428	904283	8-10 mm	OR	2	-	10
	90429	904290	8-10 mm	CB	2	-	10
	90430	904306	8-10 mm	CM	2	-	10
	90431	904313	8-10 mm	BL	2	-	10

Incluye tornillo y tapón de plástico

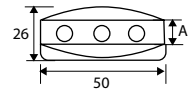

Zamak

ORO
 CROMO BRILLO
 CROMO MATE
 BLANCO

SOPORTE CRISTAL PIVOTE SC9

	Código	8431488	Medida	Acabado				€uros
Caja	31604	316048	5 mm	NI	-	100	500	

Zamak



Apertura 4-8 mm

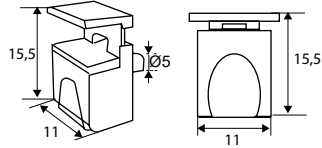

SOPORTE PELÍCANO SP5

	Código	8431488	Medida	Acabado				€uros
Caja	31209	312095	30x46 mm	CM	-	2	38	

Zamak

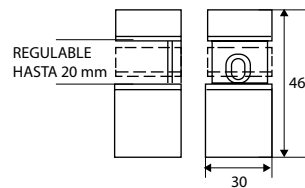

SOPORTE PELÍCANO SP6

	Código	8431488	Medida	Acabado				€uros
Caja	31210	312101	77x112 mm	CM	-	2	38	

Zamak

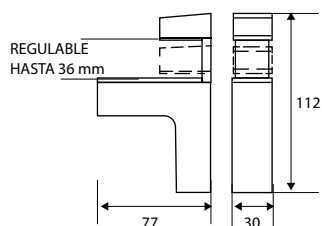

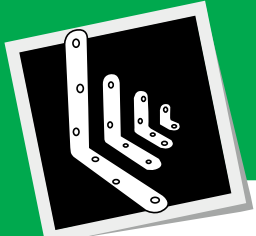

SOPORTE PELÍCANO SP8

	Código	843 I 488	Medida	Acabado				€uros
Caja	31241	312415	42x53 mm	BL	-	2	38	
	31243	312439	42x53 mm	OR	-	2	38	
	31245	312453	42x53 mm	CM	-	2	38	
Blister	91820	918204	42x53 mm	BL	2	-	10	
	91821	918211	42x53 mm	OR	2	-	10	
	91822	918228	42x53 mm	CM	2	-	10	

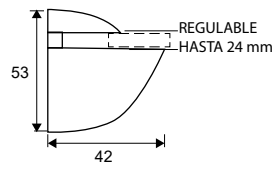

Zamak

BLANCO
 ORO
 CROMO MATE



SOPORTE PELÍCANO SP4

	Código	843 I 488	Medida	Acabado				€uros
Caja	31201	312019	75x65 mm	BL	-	2	38	
	31202	312026	75x65 mm	NE	-	2	38	
	31203	312033	75x65 mm	OR	-	2	38	
	31204	312040	75x65 mm	CB	-	2	38	
	31205	312057	75x65 mm	CM	-	2	38	
Blister	90622	906225	75x65 mm	BL	2	-	10	
	90623	906232	75x65 mm	NE	2	-	10	
	90624	906249	75x65 mm	OR	2	-	10	
	90625	906256	75x65 mm	CB	2	-	10	
	90626	906263	75x65 mm	CM	2	-	10	

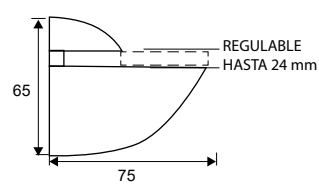

Zamak

BLANCO
 NEGRO
 ORO
 CROMO BRILLO
 CROMO MATE



SOPORTE PELÍCANO SP7

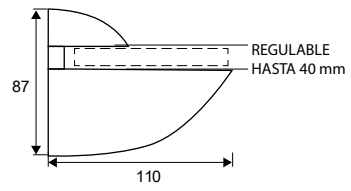

	Código	843 I 488	Medida AxB	Acabado				€uros
Caja	31221	312217	110x87 mm	BL	-	2	38	
	31222	312224	110x87 mm	NE	-	2	38	
	31223	312231	110x87 mm	OR	-	2	38	
	31224	312248	110x87 mm	CM	-	2	38	
	31225	312255	110x87 mm	NS	-	2	38	
	31226	312262	110x87 mm	CU	-	2	38	
	31227	312279	110x87 mm	LE	-	2	38	



Zamak

BLANCO
 NEGRO
 ORO
 CROMO MATE
 NIQUEL SATINADO
 CUERO
 LATÓN ENVEJECIDO

SOPORTE PELÍCANO SP1

	Código	8431488	Medida	Acabado				€uros
Caja	31206	312064	28x39 mm	CM	-	2	50	

Zamak

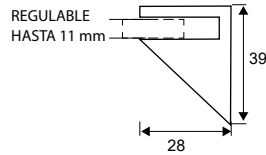



SOPORTE PELÍCANO SP2

	Código	8431488	Medida	Acabado				€uros
Caja	31207	312071	111x70 mm	CM	-	2	38	

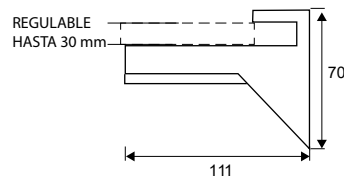
Zamak



SOPORTE PELÍCANO SP3

	Código	8431488	Medida	Acabado				€uros
Caja	31208	312088	111x70 mm	CM	-	2	38	

Zamak

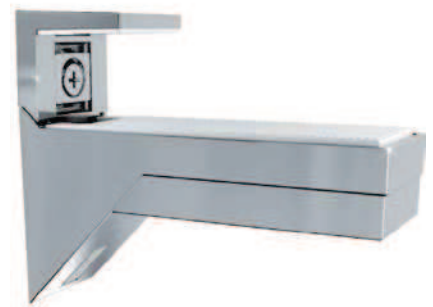
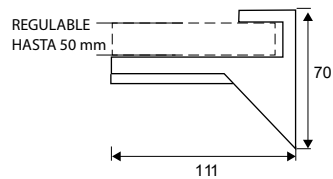

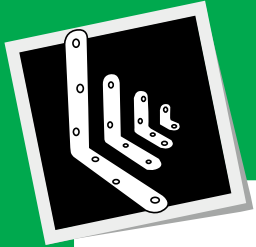

SOPORTE BALDA OCULTO SBO3



	Código	8431488	Medida A	Acabado				€uros
Caja	31121	311210	150 mm	BC	-	20	200	
	31122	311227	190 mm	BC	-	20	100	

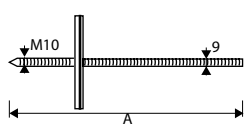

Acero

 BICROMATADO

SOPORTE BALDA OCULTO



	Código	8431488	Medida Ax B	Acabado				€uros
Caja	31123	311234	8x100 mm	ZN	-	20	100	
	31124	311241	8x140 mm	ZN	-	20	100	
	31125	311258	10x100 mm	ZN	-	20	100	
	31126	311265	10x140 mm	ZN	-	20	100	
	31127	311272	10x170 mm	ZN	-	20	100	

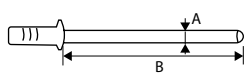

Acero

 ZINCADO

SOPORTE BALDA OCULTO SBO1



	Código	8431488	Medida	Acabado				€uros
Caja	31128	311289	150 mm	ZN	-	10	50	

Peso máx.: 15 Kgs

Zamak

 ZINCADO

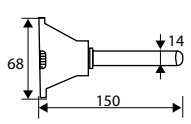

Regulación:
 Vertical - 5 mm
 Horizontal - 5 mm
 Inclinación - 5°

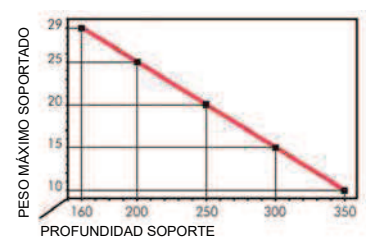

SOPORTE BALDA OCULTO SBO2



	Código	8431488	Medida	Acabado				€uros
Caja	31129	311296	150 mm	ZN	-	10	30	

Peso máx.: 25 Kgs

Zamak

 ZINCADO

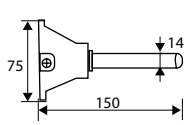

Regulación:
 Vertical - 5 mm
 Horizontal - 5 mm
 Inclinación - 5°

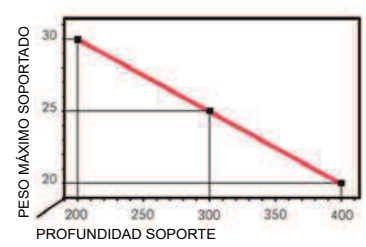

JGO SOPORTE AIRE ACONDICIONADO AC1

Código	8431488	Medida AxB	Acabado				€uros
	18516	185163	500x400 mm	BE	-	1	-
	18517	185170	500x450 mm	BE	-	1	-
	18518	185187	500x500 mm	BE	-	1	-

Acero



BEIGE

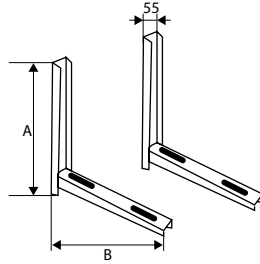

JGO AMORTIGUADORES AC2

Código	8431488	Peso	Acabado				€uros
	18519	185194	35 kgs	NE	-	1	8
	18520	185200	45 kgs	NE	-	1	5

Caucho



NEGRO

1 juego de 4 piezas

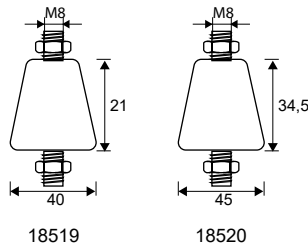

SOPORTE C/GARRAFA AIRE ACONDICIONADO AC3

Código	8431488	Medida	Acabado				€uros
	18521	185217	290x195 mm	BE	-	1	5

Acero



BEIGE

Incluye garrafa 5 litros

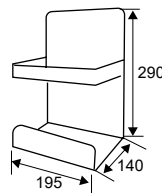

Te sugiero:



SOPORTE MICROONDAS
Pág. 343

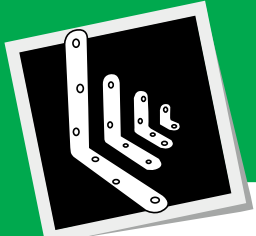

CREMALLERA PLM8

Código	843 I 488	Medida A	Acabado				€uros
51100	511009	1 mt	BL	-	1	25	
51150	511504	1,5 mts	BL	-	1	25	
51200	512006	2 mts	BL	-	1	25	
52100	521008	1 mt	PL	-	1	25	
52150	521503	1,5 mts	PL	-	1	25	
52200	522005	2 mts	PL	-	1	25	

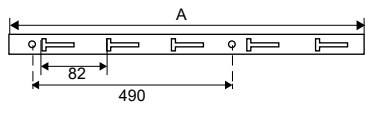

Aluminio
 BLANCO
 PLATA

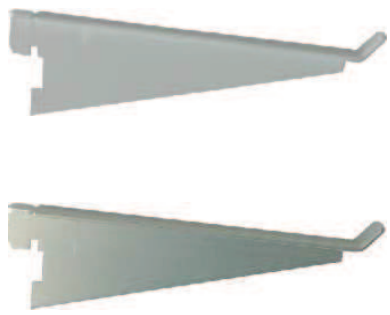

PALOMILLA PLM8

Código	843 I 488	Medida A	Acabado				€uros
50041	500416	150 mm	BL	2	-	50	
50042	500423	200 mm	BL	2	-	50	
50043	500430	250 mm	BL	2	-	50	
50044	500447	300 mm	BL	2	-	50	
50045	500454	350 mm	BL	2	-	50	
50046	500461	400 mm	BL	2	-	50	
<i>Blister</i>							
50047	500478	150 mm	PL	2	-	50	
50048	500485	200 mm	PL	2	-	50	
50049	500492	250 mm	PL	2	-	50	
50050	500508	300 mm	PL	2	-	50	
50051	500515	350 mm	PL	2	-	50	
50052	500522	400 mm	PL	2	-	50	

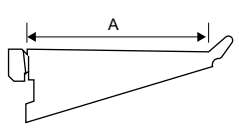

Aluminio
 BLANCO
 PLATA

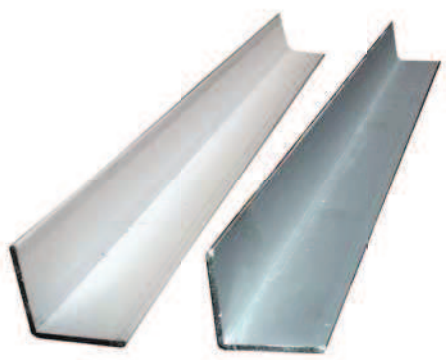

ESQUINERO AN23

Código	843 I 488	Medida AxBxC	Acabado				€uros
55062	550626	20x20x2,5 mts	BL	-	5	-	
55063	550633	20x20x2,5 mts	PL	-	5	-	
55064	550640	25x25x2,5 mts	BL	-	5	-	
55065	550657	25x25x2,5 mts	PL	-	5	-	

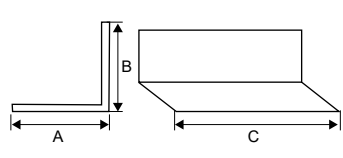

Aluminio
 BLANCO
 PLATA

PALOMILLA 3 POSICIONES PLM6

Código	8431488	Medida AxBxC	Acabado	Carga Máx				€uros
37330	373300	300x300x30 mm	BL	50 Kgs	-	10	40	
37340	373409	400x400x35 mm	BL	50 Kgs	-	6	12	
37430	374307	300x300x30 mm	CB	50 Kgs	-	10	40	
37440	374406	400x400x35 mm	CB	50 Kgs	-	6	12	

Acero

- BLANCO
- CROMO BRILLO

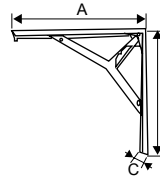

PALOMILLA ORNAMENTAL PLM5

Código	8431488	Medida AxB	Acabado	Carga Máx				€uros
33010	330105	100x90 mm	NE	75 Kgs	-	10	120	
33015	330150	150x115 mm	NE	75 Kgs	-	10	120	
33020	330204	200x150 mm	NE	100 Kgs	-	10	60	
33025	330259	250x190 mm	NE	100 Kgs	-	10	60	

Acero

- NEGRO

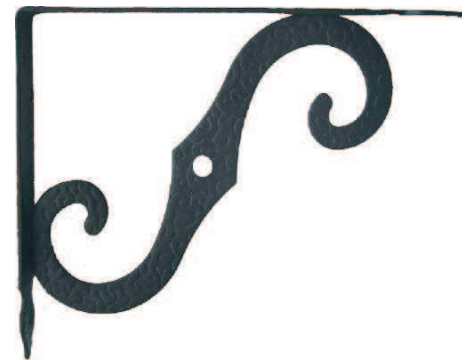
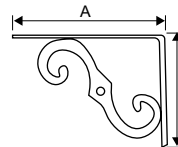

PALOMILLA REFORZADA PLM4

Código	8431488	Medida AxB	Acabado	Carga Máx				€uros
37525	375250	250x200 mm	BL	330 Kgs	-	10	-	
37530	375304	300x220 mm	BL	260 Kgs	-	10	-	
37540	375403	400x280 mm	BL	225 Kgs	-	10	-	
37550	375502	500x350 mm	BL	185 Kgs	-	10	-	
37560	375601	600x400 mm	BL	150 Kgs	-	10	-	
37625	376257	250x200 mm	GR	330 Kgs	-	10	-	
37630	376301	300x220 mm	GR	260 Kgs	-	10	-	
37640	376400	400x280 mm	GR	225 Kgs	-	10	-	
37650	376509	500x350 mm	GR	185 Kgs	-	10	-	
37660	376608	600x400 mm	GR	150 Kgs	-	10	-	

Acero

- BLANCO
- GRIS

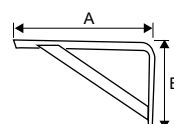

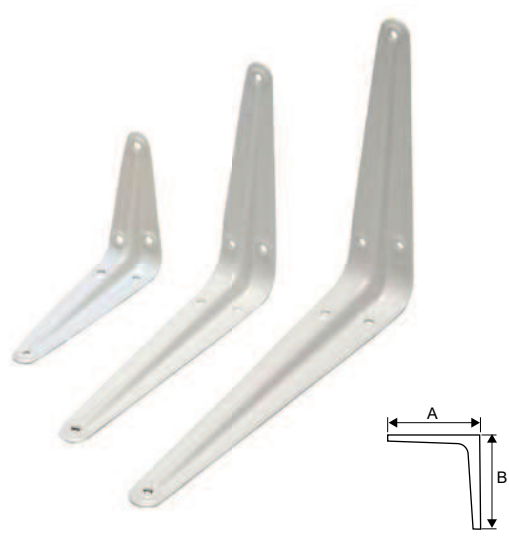
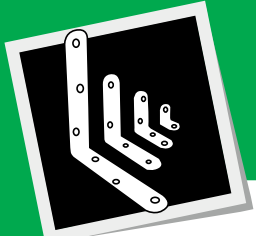

PALOMILLA CLÁSICA PLM1

Código	8431488	Medida AxB	Acabado	Carga Máx				€uros
80100	801001	100x75 mm	BL	20 Kgs	-	20	400	
80125	801254	125x100 mm	BL	20 Kgs	-	20	400	
80150	801506	150x125 mm	BL	20 Kgs	-	20	400	
80175	801759	175x150 mm	BL	25 Kgs	-	20	400	
80200	802008	200x150 mm	BL	25 Kgs	-	20	200	
80250	802503	250x200 mm	BL	30 Kgs	-	20	200	
80300	803005	300x250 mm	BL	30 Kgs	-	20	100	
80350	803500	350x300 mm	BL	35 Kgs	-	20	100	
80400	804002	400x350 mm	BL	40 Kgs	-	20	80	
80450	804507	450x400 mm	BL	40 Kgs	-	20	80	

Acero



PALOMILLA PLUS PLM2

Código	8431488	Medida AxB	Acabado	Carga Máx				€uros
80453	804538	150x125 mm	BL	30 Kgs	-	20	160	
80454	804545	200x150 mm	BL	30 Kgs	-	20	140	
80455	804552	250x200 mm	BL	30 Kgs	-	20	100	
80456	804569	300x250 mm	BL	30 Kgs	-	20	60	
80457	804576	350x300 mm	BL	30 Kgs	-	20	60	
80458	804583	150x125 mm	NE	30 Kgs	-	20	160	
80459	804590	200x150 mm	NE	30 Kgs	-	20	140	
80460	804606	250x200 mm	NE	30 Kgs	-	20	100	
80461	804613	300x250 mm	NE	30 Kgs	-	20	60	
80462	804620	350x300 mm	NE	30 Kgs	-	20	60	
80463	804637	150x125 mm	GR	30 Kgs	-	20	160	
80464	804644	200x150 mm	GR	30 Kgs	-	20	140	
80465	804651	250x200 mm	GR	30 Kgs	-	20	100	
80466	804668	300x250 mm	GR	30 Kgs	-	20	60	
80467	804675	350x300 mm	GR	30 Kgs	-	20	60	

Acero

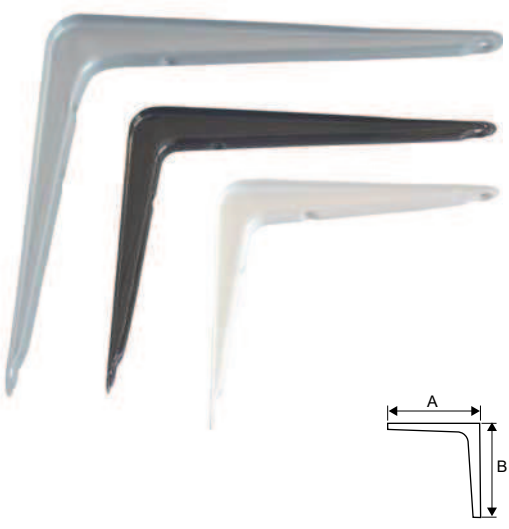

PALOMILLA PLM7

Código	8431488	Medida AxB	Acabado	Carga Máx				€uros
80468	804682	150x100 mm	BL	25 Kgs	-	25	200	
80469	804699	200x150 mm	BL	25 Kgs	-	20	200	
80470	804705	250x200 mm	BL	25 Kgs	-	10	100	
80471	804712	300x200 mm	BL	25 Kgs	-	10	100	
80472	804729	150x100 mm	NE	25 Kgs	-	25	200	
80473	804736	200x150 mm	NE	25 Kgs	-	20	200	
80474	804743	250x200 mm	NE	25 Kgs	-	10	100	
80475	804750	300x200 mm	NE	25 Kgs	-	10	100	
80476	804767	150x100 mm	GR	25 Kgs	-	25	200	
80477	804774	200x150 mm	GR	25 Kgs	-	20	200	
80478	804781	250x200 mm	GR	25 Kgs	-	10	100	
80479	804798	300x200 mm	GR	25 Kgs	-	10	100	

Aluminio

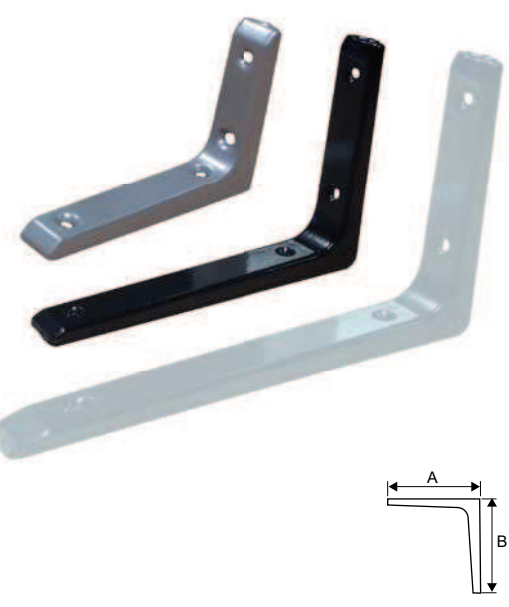

PALOMILLA SUPER PLM3

Código	8431488	Medida AxB	Acabado	Carga Máx				€uros
35101	351018	125x125 mm	BL	50 Kgs	-	25	250	
35102	351025	150x125 mm	BL	25 Kgs	-	25	150	
35103	351032	200x150 mm	BL	30 Kgs	-	20	100	
35104	351049	250x200 mm	BL	35 Kgs	-	10	50	
35105	351056	300x250 mm	BL	40 Kgs	-	10	40	
35106	351063	350x250 mm	BL	45 Kgs	-	6	18	
35107	351070	400x300 mm	BL	50 Kgs	-	6	12	



Acero

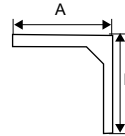

BLANCO



ÁNGULO SUPER AN3

Código	8431488	Medida AxB	Acabado				€uros
35030	350301	30x30 mm	BL	-	100	1000	
35050	350509	50x50 mm	BL	-	100	500	
35075	350752	75x75 mm	BL	-	50	500	
35100	351001	100x100 mm	BL	-	50	500	
36030	360300	30x30 mm	NE	-	100	1000	
36050	360508	50x50 mm	NE	-	100	500	
36075	360751	75x75 mm	NE	-	50	500	
36100	361000	100x100 mm	NE	-	50	500	
35530	355306	30x30 mm	ZN	-	100	1000	
35550	355504	50x50 mm	ZN	-	100	500	
35575	355757	75x75 mm	ZN	-	50	500	
35510	355108	100x100 mm	ZN	-	50	500	
91024	982236	30x30 mm	BL	-	100	100	
91025	982243	50x50 mm	BL	-	100	100	
91026	982250	75x75 mm	BL	-	50	50	
91027	982267	100x100 mm	BL	-	50	50	
91028	982274	30x30 mm	ZN	-	100	100	
91029	982281	50x50 mm	ZN	-	100	100	
91030	982298	75x75 mm	ZN	-	50	50	
91031	982304	100x100 mm	ZN	-	50	50	
90444	904443	30x30 mm	BL	4	-	10	
90446	904467	50x50 mm	BL	4	-	10	
90448	904481	75x75 mm	BL	4	-	10	
90658	906584	100x100 mm	BL	4	-	10	
90445	904450	30x30 mm	NE	4	-	10	
90447	904474	50x50 mm	NE	4	-	10	
90449	904498	75x75 mm	NE	4	-	10	
90659	906591	100x100 mm	NE	4	-	10	
92375	923758	30x30 mm	ZN	4	-	10	
92376	923765	50x50 mm	ZN	4	-	10	
92377	923772	75x75 mm	ZN	4	-	10	
92378	923789	100x100 mm	ZN	4	-	10	

Acero



BLANCO



NEGRO



ZINCADO

 Incluye tornillos en el blister

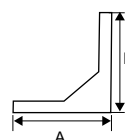

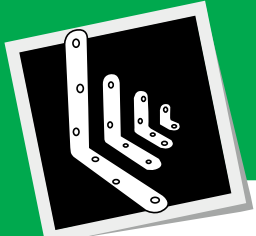

ÁNGULO REFUERZO AN1



	Código	843 1488	Medida AxBxC	Acabado				€uros
Caja	39020	390208	20x20x19 mm	BC	-	100	1200	
	39030	390307	30x30x19 mm	BC	-	100	1200	
	39040	390406	40x40x19 mm	BC	-	100	1200	
	39050	390505	50x50x19 mm	BC	-	100	700	
	39060	390604	60x60x19 mm	BC	-	100	700	
	39080	390802	80x80x19 mm	BC	-	100	500	
	39100	391007	100x100x19 mm	BC	-	50	250	
	91000	982137	20x20x19 mm	BC	-	100	1200	
	91001	982144	30x30x19 mm	BC	-	100	1200	
	91002	982151	40x40x19 mm	BC	-	100	1200	
	91003	982168	50x50x19 mm	BC	-	100	700	
	91004	982175	60x60x19 mm	BC	-	100	700	
	91005	977515	80x80x19 mm	BC	-	100	500	
	91006	981697	100x100x19 mm	BC	-	50	250	
Blister	90433	904337	20x20x19 mm	BC	4	-	10	
	90434	904344	30x30x19 mm	BC	4	-	10	
	90435	904351	40x40x19 mm	BC	4	-	10	
	90436	904368	50x50x19 mm	BC	4	-	10	
	90437	904375	60x60x19 mm	BC	4	-	10	
	90438	904382	80x80x19 mm	BC	4	-	10	
	90655	906553	100x100x19 mm	BC	4	-	10	

Incluye tornillos en el blister
Espesor 2 mm

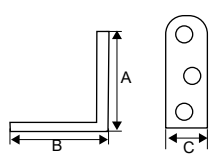

Acero
 BICROMATADO

Presentación
Bolsa de 10 unidades

ÁNGULO REFUERZO AN1



	Código	843 1488	Medida AxBxC	Acabado				€uros
Caja	39000	390000	20x20x19 mm	BL	-	100	2500	
	39001	390017	30x30x19 mm	BL	-	100	1000	
	39002	390024	40x40x19 mm	BL	-	100	1000	
	39003	390031	50x50x19 mm	BL	-	100	100	
	39004	390048	60x60x19 mm	BL	-	100	100	
	91624	982182	20x20x19 mm	BL	-	100	2500	
	91625	982199	30x30x19 mm	BL	-	100	1000	
	91626	982205	40x40x19 mm	BL	-	100	1000	
	91627	982212	50x50x19 mm	BL	-	100	500	
	91628	982229	60x60x19 mm	BL	-	100	500	
	Blister	91140	911403	20x20x19 mm	BL	4	-	10
91141		911410	30x30x19 mm	BL	4	-	10	
91142		911427	40x40x19 mm	BL	4	-	10	
91143		911434	50x50x19 mm	BL	4	-	10	
91144		911441	60x60x19 mm	BL	4	-	10	

Incluye tornillos en el blister
Espesor 2 mm

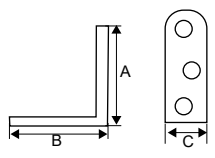

Acero
 BLANCO

ÁNGULO REFUERZO AN2

	Código	8431488	Medida AxBxC	Acabado				€uros
Caja	39101	391014	20x20x15 mm	ZN	-	100	-	
	39102	391021	30x30x15 mm	ZN	-	100	-	
	39103	391038	40x40x15 mm	ZN	-	100	-	
	39104	391045	50x50x15 mm	ZN	-	100	-	
	39105	391052	60x60x15 mm	ZN	-	100	-	
	39106	391069	80x80x15 mm	ZN	-	100	-	
	39107	391076	100x100x15 mm	ZN	-	100	-	
	91082	982311	20x20x15 mm	ZN	-	100	-	
	91083	982328	30x30x15 mm	ZN	-	100	-	
	91084	982335	40x40x15 mm	ZN	-	100	-	
	91085	982342	50x50x15 mm	ZN	-	100	-	
	91086	982359	60x60x15 mm	ZN	-	100	-	
	91087	982366	80x80x15 mm	ZN	-	100	-	
	91088	982373	100x100x15 mm	ZN	-	100	-	
Blister	91122	911229	20x20x15 mm	ZN	4	-	10	
	91123	911236	30x30x15 mm	ZN	4	-	10	
	91124	911243	40x40x15 mm	ZN	4	-	10	
	91125	911250	50x50x15 mm	ZN	4	-	10	
	91126	911267	60x60x15 mm	ZN	4	-	10	
	91127	911274	80x80x15 mm	ZN	4	-	10	

Acero



ZINCADO

Incluye tornillos en el blister

Espesor 2 mm

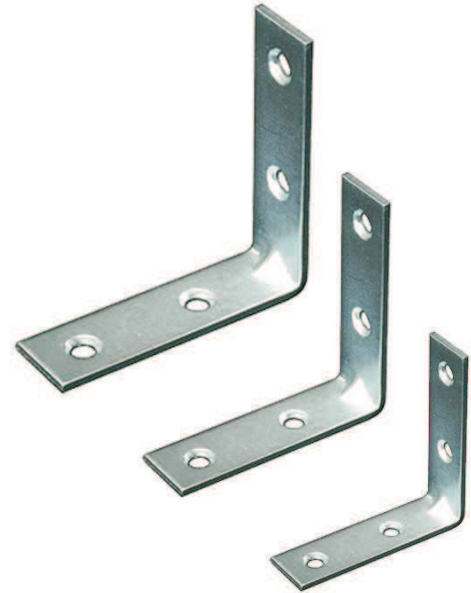
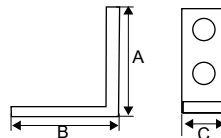

ÁNGULO REFUERZO AN4

	Código	8431488	Medida AxBxC	Acabado				€uros
	39121	981758	20x20x30 mm	ZN	-	50	-	
	39122	981765	30x30x30 mm	ZN	-	50	-	
	39123	981772	40x40x30 mm	ZN	-	50	-	
	39124	981789	50x50x30 mm	ZN	-	50	-	
	39125	981796	60x60x30 mm	ZN	-	50	-	

Acero



ZINCADO

Incluye tornillos en el blister

Espesor 2 mm

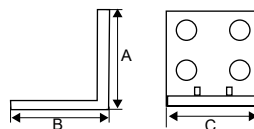

ÁNGULO FIJACIÓN AN10

	Código	8431488	Medida AxBxC	Acabado				€uros
	39131	981857	38x28x23 mm	ZN	-	100	-	
Blister	91139	911397	38x28x23 mm	ZN	4	-	10	

Acero



ZINCADO

Incluye tornillos en el blister

Espesor 2 mm

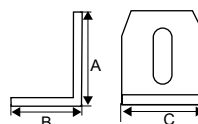

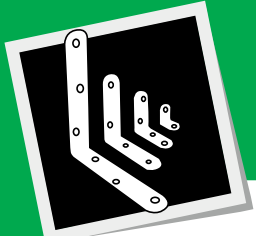

ÁNGULO FIJACIÓN AN11

Código	843 1488	Medida AxBxC	Acabado				€uros
39132	981864	28x28x30 mm	ZN	-	100	-	

Incluye tornillos en el blíster
Espesor 1 mm

Acero
 ZINCADO

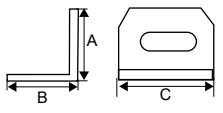

ÁNGULO REFUERZO AN5



Código	843 1488	Medida AxBxC	Acabado				€uros
39116	981666	20x20x40 mm	ZN	-	100	-	
Blister 91134	911342	20x20x40 mm	ZN	4	-	10	

Incluye tornillos en el blíster
Espesor 1 mm

Acero
 ZINCADO

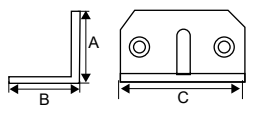

ÁNGULO REFUERZO AN6



Código	843 1488	Medida AxBxC	Acabado				€uros
39117	981703	20x20x50 mm	ZN	-	100	-	
Blister 91135	911359	20x20x50 mm	ZN	4	-	10	

Incluye tornillos en el blíster
Espesor 1 mm

Acero
 ZINCADO

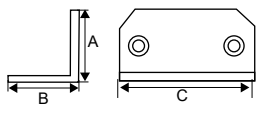

ÁNGULO REFUERZO AN7



Código	843 1488	Medida AxBxC	Acabado				€uros
39118	981710	21x21x67 mm	ZN	-	100	-	
Blister 91136	911366	21x21x67 mm	ZN	4	-	10	

Incluye tornillos en el blíster
Espesor 1 mm

Acero
 ZINCADO

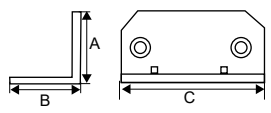

ÁNGULO REFUERZO AN8

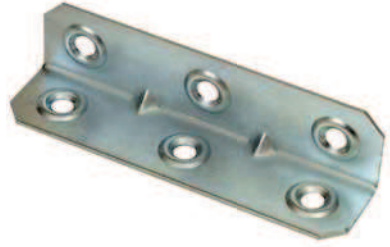

Código	843 1488	Medida AxBxC	Acabado				€uros
39119	981727	21x21x86 mm	ZN	-	100	-	
Blister 91137	911373	21x21x86 mm	ZN	4	-	10	

Incluye tornillos en el blíster
Espesor 1 mm

Acero
 ZINCADO

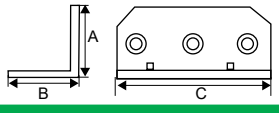

ÁNGULO REFUERZO AN9

	Código	8431488	Medida AxByC	Acabado				€uros
	39120	981741	40x40x90 mm	ZN	-	50	-	
<i>Blister</i>	91138	911380	40x40x90 mm	ZN	4	-	10	

Acero



ZINCADO

Incluye tornillos en el blister
Espesor 1 mm

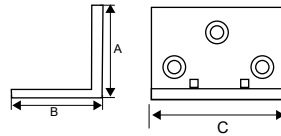

PLACA CUADRADA PLC6

	Código	8431488	Medida AxB	Acabado				€uros
	39114	981642	45x45 mm	ZN	-	100	-	
<i>Blister</i>	91132	911328	45x45 mm	ZN	4	-	10	

Acero



ZINCADO

Incluye tornillos en el blister
Espesor 1 mm

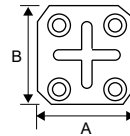

PLACA RECTANGULAR PLC7

	Código	8431488	Medida AxB	Acabado				€uros
	39115	981659	70x35 mm	ZN	-	100	-	
<i>Blister</i>	91133	911335	70x35 mm	ZN	4	-	10	

Acero



ZINCADO

Incluye tornillos en el blister
Espesor 1 mm

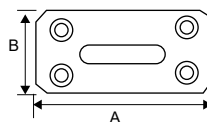

PLACA RECTA UNIÓN PLC8

	Código	8431488	Medida AxB	Acabado				€uros
	39126	981802	40x30 mm	ZN	-	50	-	
	39127	981819	60x30 mm	ZN	-	50	-	
	39128	981826	80x30 mm	ZN	-	50	-	
	39129	981833	100x30 mm	ZN	-	50	-	
	39130	981840	120x30 mm	ZN	-	50	-	

Acero



ZINCADO

Espesor 2 mm

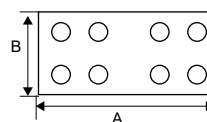

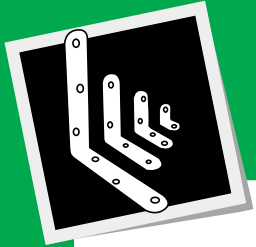

Espesor 1,5 mm		Espesor 2 mm	
38040-38060	38040-38060	38080-38100-38120	38080-38100-38120
91019-91020	91019-91020	91021-91022-91023	91021-91022-91023
90516-90517	90516-90517	90518-90519	90518-90519

PLACA RECTA UNIÓN PLC1

	Código	8431488	Medida AxB	Acabado				€uros
Caja	38040	380407	40x16 mm	BC	-	100	1000	
	38060	380605	60x16 mm	BC	-	100	1000	
	38080	380803	80x19 mm	BC	-	100	500	
	38100	381008	100x19 mm	BC	-	100	500	
	38120	381206	120x19 mm	BC	-	100	500	
	91019	983547	40x16 mm	BC	-	100	1000	
	91020	982458	60x16 mm	BC	-	100	1000	
	91021	981680	80x19 mm	BC	-	100	500	
	91022	982496	100x19 mm	BC	-	100	500	
	91023	982434	120x19 mm	BC	-	100	500	
Blister	90516	905167	40x16 mm	BC	4	-	10	
	90517	905174	60x16 mm	BC	4	-	10	
	90518	905181	80x19 mm	BC	4	-	10	
	90519	905198	100x19 mm	BC	4	-	10	

Incluye tornillos en el blister

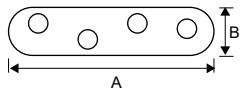

Acero
 BICROMATADO

PLACA RECTA UNIÓN PLC2



	Código	8431488	Medida AxB	Acabado				€uros
Caja	38240	382401	40x15 mm	ZN	-	100	-	
	38260	382609	60x15 mm	ZN	-	100	-	
	38280	382807	80x15 mm	ZN	-	100	-	
	38210	382104	100x15 mm	ZN	-	100	-	
	38212	382128	120x15 mm	ZN	-	100	-	
	91014	982410	40x15 mm	ZN	-	100	-	
	91015	982908	60x15 mm	ZN	-	100	-	
	91016	982885	80x15 mm	ZN	-	100	-	
	91017	982427	100x15 mm	ZN	-	100	-	
	91018	983523	120x15 mm	ZN	-	100	-	
Blister	90520	905204	40x15 mm	ZN	4	-	10	
	90521	905211	60x15 mm	ZN	4	-	10	
	90522	905228	80x15 mm	ZN	4	-	10	
	90523	905235	100x15 mm	ZN	4	-	10	

Incluye tornillos en el blister

Espesor 2 mm

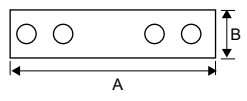

Acero
 ZINCADO

PLACA CARTELA PLC3

	Código	8431488	Medida AxB	Acabado				€uros
Caja	38130	381305	30x13 mm	ZN	-	300	3000	
	38140	381404	40x15 mm	ZN	-	200	2000	
	38150	381503	50x17 mm	ZN	-	200	2000	
	38160	381602	60x20 mm	ZN	-	100	1000	
Blister	90844	908441	30x13 mm	ZN	4	-	10	
	90845	908458	40x15 mm	ZN	4	-	10	
	90846	908465	50x17 mm	ZN	4	-	10	
	90847	908472	60x20 mm	ZN	4	-	10	

Acero



Incluye tornillos en el blister
Espesor 1 mm

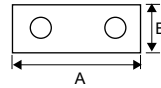
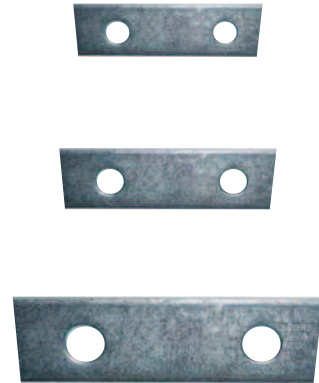

ESCUADRA PLANA PLC4

	Código	8431488	Medida AxB	Acabado				€uros
Caja	37030	370309	30x30x12 mm	BC	-	100	1000	
	37040	370408	40x40x12 mm	BC	-	100	1000	
	37051	370514	50x50x14 mm	BC	-	100	1000	
	37060	370606	60x60x15 mm	BC	-	100	500	
	37080	370804	80x80x17 mm	BC	-	100	500	
	37100	371009	100x100x17 mm	BC	-	100	500	
	37120	371207	120x120x17 mm	BC	-	100	500	
	91007	981734	30x30x12 mm	BC	-	100	1000	
	91008	983554	40x40x12 mm	BC	-	100	1000	
	91009	983462	50x50x14 mm	BC	-	100	1000	
	91010	983479	60x60x15 mm	BC	-	100	500	
	91011	983486	80x80x17 mm	BC	-	100	500	
	91012	982441	100x100x17 mm	BC	-	100	500	
	91013	983455	120x120x17 mm	BC	-	100	500	
Blister	90439	904399	30x30x12 mm	BC	8	-	10	
	90440	904405	40x40x12 mm	BC	8	-	10	
	90441	904412	50x50x14 mm	BC	4	-	10	
	90442	904429	60x60x15 mm	BC	4	-	10	
	90443	904436	80x80x17 mm	BC	4	-	10	
	90656	906560	100x100x17 mm	BC	4	-	10	
	90657	906577	120x120x17 mm	BC	4	-	10	

Acero



Incluye tornillos en el blister

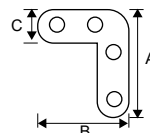
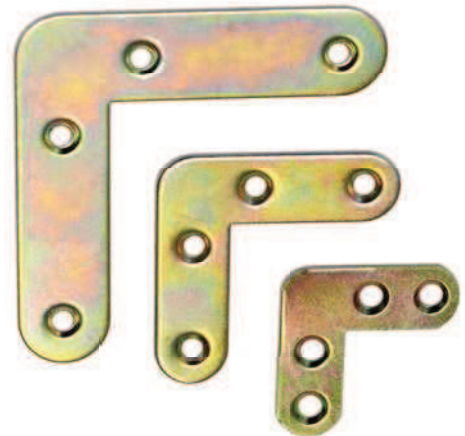

Esesor 0,9 mm	Esesor 1 mm	Esesor 1,2 mm
37030-37040-37051-37060	37080	37100-37120
91007-91008-91009-91010	91011	91012-91013
90439-90440-90441-90442	90443	90656-90657

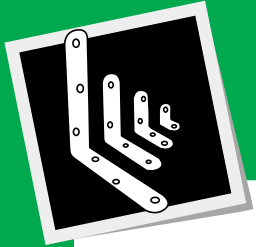

ESCUADRA PLANA PLC5

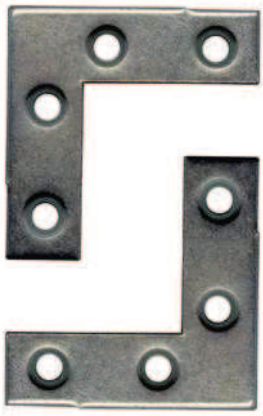

Espesor 1,8 mm		Espesor 2 mm	
39108-39109-39110		39111-39112-39113	
91089-91090-91091		91092-91093-91094	
91128-91129-91130		91131	

	Código	843 I 488	Medida AxBxC	Acabado				€uros
Caja	39108	391083	40x40x12 mm	ZN	-	100	-	
	39109	391090	50x50x12 mm	ZN	-	100	-	
	39110	391106	60x60x12 mm	ZN	-	100	-	
	39111	391113	80x80x18 mm	ZN	-	100	-	
	39112	391120	100x100x18 mm	ZN	-	50	-	
	39113	391137	120x120x18 mm	ZN	-	50	-	
	91089	983561	40x40x12 mm	ZN	-	100	-	
	91090	983578	50x50x12 mm	ZN	-	100	-	
	91091	983585	60x60x12 mm	ZN	-	100	-	
	91092	983592	80x80x18 mm	ZN	-	100	-	
	91093	983530	100x100x18 mm	ZN	-	50	-	
	91094	982915	120x120x18 mm	ZN	-	50	-	
Blister	91128	911281	40x40x12 mm	ZN	4	-	10	
	91129	911298	50x50x12 mm	ZN	4	-	10	
	91130	911304	60x60x12 mm	ZN	4	-	10	
	91131	911311	80x80x18 mm	ZN	4	-	10	

Incluye tornillos en el blister

Acero

ZINCADO

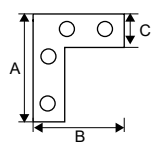

PLACA PESANTE PLC9



	Código	843 I 488	Medida AxB	Acabado				€uros
	39134	981888	80x50 mm	ZN	-	50	-	
	39135	981895	120x50 mm	ZN	-	50	-	
	39136	981901	160x50 mm	ZN	-	25	-	
	39137	981918	200x50 mm	ZN	-	25	-	

Espesor 2,5 mm

Acero

ZINCADO

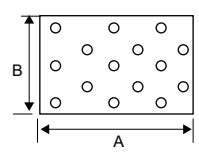

PLACA RECTA PERFORADA PLC10



	Código	843 I 488	Medida AxB	Acabado				€uros
	39156	982106	160x40 mm	ZN	-	50	-	
	39157	982113	200x60 mm	ZN	-	25	-	
	39158	982120	240x80 mm	ZN	-	25	-	

Espesor 2,5 mm

Acero

ZINCADO

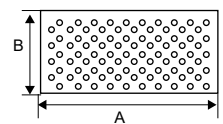

ÁNGULO PESANTE AN12

	Código	8431488	Medida AxBxC	Acabado				€uros
	39149	982038	40x40x20 mm	ZN	-	100	-	
	39150	982045	40x40x40 mm	ZN	-	50	-	
	39151	982052	50x50x40 mm	ZN	-	50	-	

Acero

Espesor 2 mm



ZINCADO

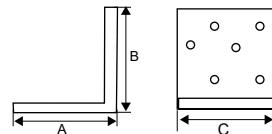

ÁNGULO PESANTE AN13

	Código	8431488	Medida AxBxC	Acabado				€uros
	39138	981925	40x40x50 mm	ZN	-	50	-	
	39139	981932	60x60x50 mm	ZN	-	50	-	
	39140	981949	80x80x50 mm	ZN	-	25	-	
	39141	981956	100x100x50 mm	ZN	-	25	-	

Acero

Espesor 2 mm



ZINCADO

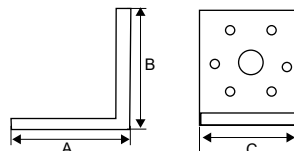

ÁNGULO PESANTE AN14

	Código	8431488	Medida AxBxC	Acabado				€uros
	39152	982069	60x60x40 mm	ZN	-	50	-	
	39153	982076	60x60x60 mm	ZN	-	50	-	
	39154	982083	60x60x80 mm	ZN	-	25	-	
	39155	982090	80x80x80 mm	ZN	-	25	-	

Acero

Espesor 2 mm



ZINCADO

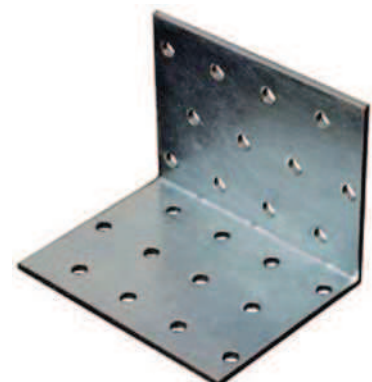
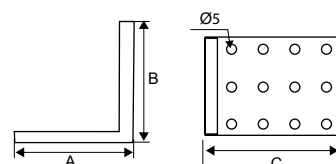

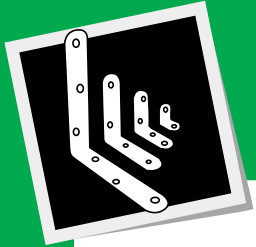

ÁNGULO PESANTE AN15



Código	843 1488	Medida	Acabado				€uros
39142	981963	60x60x50 mm	ZN	-	50	-	

Espesor 2,5 mm

Acero

ZINCADO

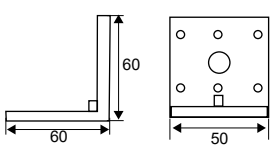

ÁNGULO PESANTE AN16



Código	843 1488	Medida	Acabado				€uros
39143	981970	85x85x65 mm	ZN	-	25	-	

Espesor 2,5 mm

Acero

ZINCADO

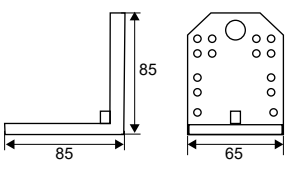

ÁNGULO PESANTE AN17



Código	843 1488	Medida	Acabado				€uros
39144	981987	100x100x90 mm	ZN	-	20	-	

Espesor 2,5 mm

Acero

ZINCADO

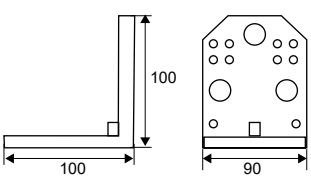

ÁNGULO PESANTE 135° AN18



Código	843 1488	Medida	Acabado				€uros
39145	981994	80x80x50 mm	ZN	-	25	-	

Espesor 2,5 mm

Acero

ZINCADO

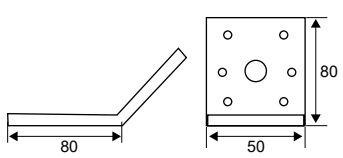

PLACA FORMA "T" PLC11

Código	8431488	Medida	Acabado				€uros
39146	982007	160x45x100 mm	ZN	-	20	-	

Acero



ZINCADO

Espesor 2,5 mm

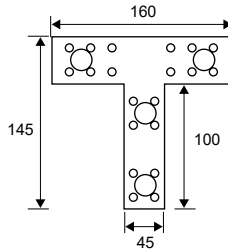

ÁNGULO ANCLAJE C/TORNILLO AN19

Código	8431488	Medida	Acabado				€uros
39133	981871	30x36 mm	ZN	-	50	-	

Acero



ZINCADO

Espesor 2 mm

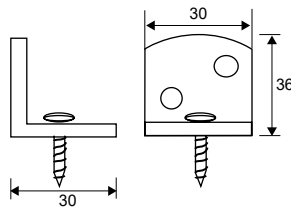

PLACA C/TUERCA PLC12

Código	8431488	Medida	Acabado				€uros
39147	982014	M8x50x50 mm	ZN	-	50	-	
39148	982021	M10x50x50 mm	ZN	-	50	-	
<i>Blister</i> 92205	922058	M8x50x50 mm	ZN	1	-	10	
92206	922065	M10x50x50 mm	ZN	1	-	10	

Acero



ZINCADO

Espesor 3 mm

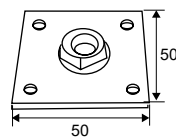

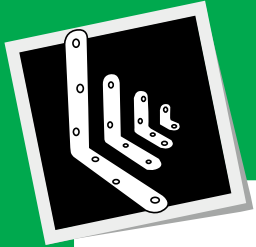

SOPORTE VIGA INCLINADO SV1



Código	8431488	Medida AxBxC	Acabado				€uros
39175	391755	70x70x80 mm	ZN	-	1	15	
39176	391762	90x90x95 mm	ZN	-	1	10	

Espesor 3 mm

Acero

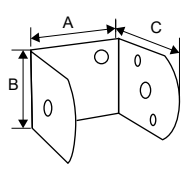

SOPORTE VIGA ABIERTO SV2



Código	8431488	Medida AxB	Acabado				€uros
39159	391595	70x125 mm	ZN	-	1	15	
39161	391618	80x120 mm	ZN	-	1	15	
39163	391632	100x140 mm	ZN	-	1	15	

Espesor 2 mm

Acero

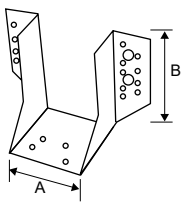

SOPORTE VIGA CERRADO SV3



Código	8431488	Medida AxB	Acabado				€uros
39160	391601	70x125 mm	ZN	-	1	15	
39162	391625	80x120 mm	ZN	-	1	15	
39164	391649	100x140 mm	ZN	-	1	15	

Espesor 2 mm

Acero

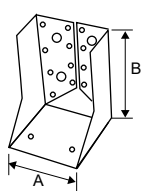

SOPORTE VIGA PIE SV4

	Código	8431488	Medida AxB	Acabado				€uros
	39166	391663	71x71 mm	ZN	-	1	4	
	39167	391670	91x91 mm	ZN	-	1	4	
	39169	391694	121x121 mm	ZN	-	1	4	

Acero

Espesor 4 mm



ZINCADO

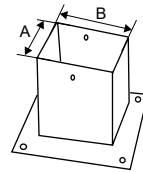

SOPORTE VIGA CLAVAR SV5

	Código	8431488	Medida AxB	Acabado				€uros
	39173	391731	70x70 mm	ZN	-	1	2	
	39174	391748	90x90 mm	ZN	-	1	2	

Acero

Espesor 4 mm



ZINCADO

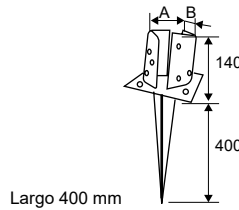

Largo 400 mm



SOPORTE POSTE SUELO SV8

	Código	8431488	Medida A	Acabado				€uros
	39179	391793	80 mm	ZN	-	1	4	
	39180	391809	100 mm	ZN	-	1	4	
	39181	391816	120 mm	ZN	-	1	4	

Acero

Espesor 4 mm



ZINCADO

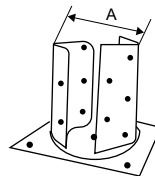

SOPORTE POSTE CLAVAR SV9

	Código	8431488	Medida A	Acabado				€uros
	39182	391823	80 mm	ZN	-	1	2	
	39183	391830	100 mm	ZN	-	1	2	

Acero

Espesor 4 mm



ZINCADO

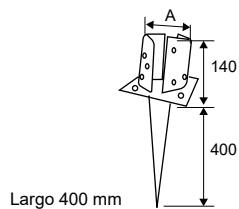

Largo 400 mm



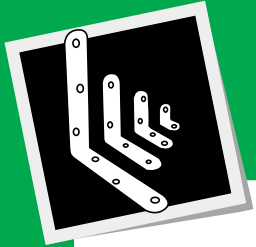

SOPORTE POSTE REDONDO SV6

Código	8431488	Medida	Acabado				€uros
39177	391779	80-100 mm	ZN	-	1	25	

Espesor 2,5 mm

Acero

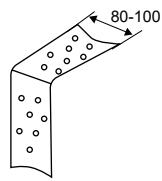

SOPORTE POSTE REDONDO SV7

Código	8431488	Medida	Acabado				€uros
39178	391786	80-100 mm	ZN	-	1	25	

Espesor 2,5 mm

Acero

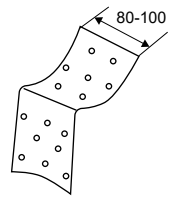



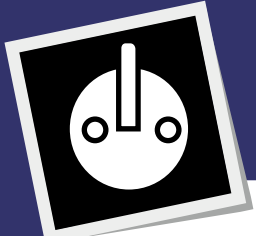

GANCHO COLGADOR CG1



	Código	8431488	Medida	Acabado				€uros
Caja	39511	395111	70x15 mm	ZN	-	50	500	

Incluye tornillo regulador

Acero



ZINCADO

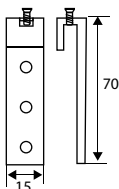

PLACA COLGADOR CG2



	Código	8431488	Medida	Acabado				€uros
Caja	39501	395012	50x50 mm	ZN	-	50	500	

Acero



ZINCADO

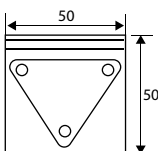

JGO GANCHO COLGADOR CG1 + PLACA CG2

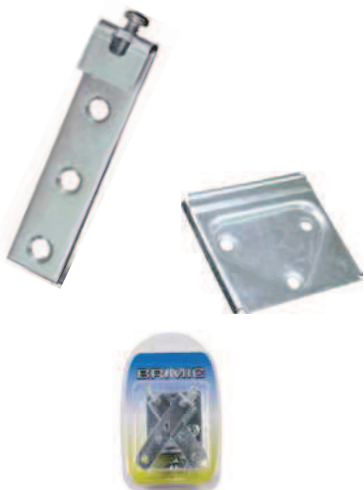

	Código	8431488	Tipo	Acabado				€uros
Caja	00206	002064	gancho+placa	ZN	-	50	250	
Blister	90316	903163	gancho+placa	ZN	2+2	-	10	

Incluye tornillos en el blister

Acero



ZINCADO

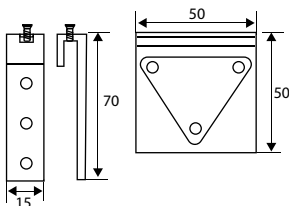

COLGADOR ESCUADRA CG3

	Código	8431488	Medida/Mano	Acabado				€uros
Caja	39521	395210	72 mm / Dcha	ZN	-	50	500	
	39522	395227	72 mm / Izda	ZN	-	50	500	

Acero

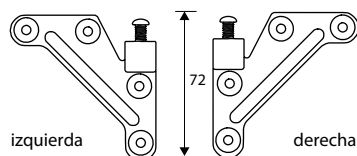

JGO COLGADOR ESCUADRA CG3 + PLACA CG2

	Código	8431488	Medida	Acabado				€uros
Blistar	90315	903156	72x72 mm	ZN	1 izda +1 dcha +2	-	10	

Acero

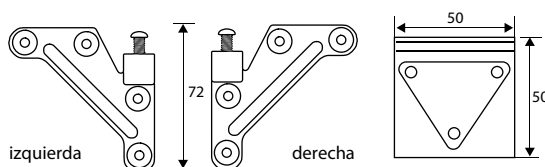

Incluye tornillos en el blister



COLGADOR BIVALENTE CG4

	Código	8431488	Medida	Acabado				€uros
Caja	39541	395418	59x49 mm	BL	-	25	250	
	39542	395425	59x49 mm	BE	-	25	250	

Acero y ABS

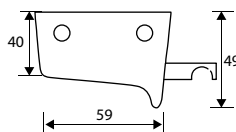

JGO COLGADOR BIVALENTE CG4 + PLACA CG2

	Código	8431488	Medida	Acabado				€uros
Blistar	90317	903170	59x49 mm	BL	2+2	-	10	
	90318	903187	59x49 mm	BE	2+2	-	10	

Acero y ABS

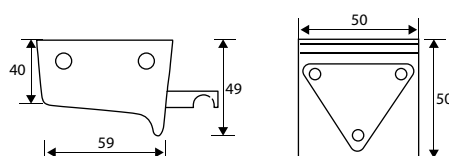

Incluye tornillos en el blister



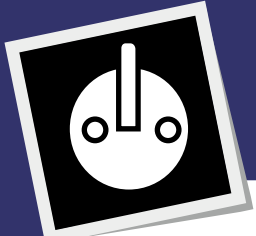

JGO COLGADOR COCINA OCULTO CG5

	Código	8431488	Medida	Acabado				€uros
Caja	39561	395616	160x56 mm	ZN	-	50	-	
Blister	92428	924281	160x56 mm	ZN	1	-	10	

Carga máxima útil por colgador 65 Kgs
Ajustable en altura 18 mm
Regulable en profundidad 9 mm

Acero

ZINCADO

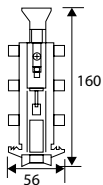

PLACA COLGADOR TIRA CG20

	Código	8431488	Medida	Acabado				€uros
Caja	39552	395524	2 mts	ZN	-	10	-	

Acero

ZINCADO

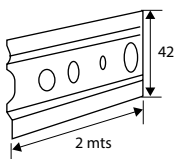

PLACA COLGADOR DOBLE CG21

	Código	8431488	Medida	Acabado				€uros
Caja	39551	395517	130x30 mm	ZN	-	100	500	

Acero

ZINCADO

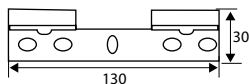

COLGADOR ESCUADRA REGULABLE CG6

	Código	8431488	Medida	Acabado				€uros
Caja	39531	395319	51x48 mm	ZN	-	50	250	

Acero

ZINCADO

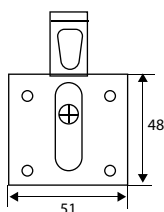

COLGADOR ESCUADRA TRIÁNGULO CG7

	Código	8431488	Medida	Acabado				€uros
Caja	39500	395005	70x70 mm	ZN	-	100	500	
Blister	90838	908380	70x70 mm	ZN	2	-	10	

Acero



ZINCADO

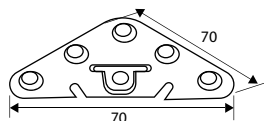

COLGADOR MUEBLE REVERSIBLE CG8

	Código	8431488	Medida	Acabado				€uros
Caja	30881	308814	45x35 mm	ZN	-	100	1000	
Blister	91700	917009	45x35 mm	ZN	4	-	10	

Acero



ZINCADO



Incluye tornillos en el blister
Espesor 1,5 mm

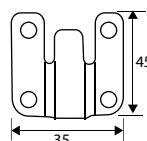

COLGADOR MUEBLE CG9

	Código	8431488	Medida	Acabado				€uros
Caja	30850	308500	50x15 mm	ZN	-	100	1000	
	30880	308807	80x15 mm	ZN	-	100	1000	
Blister	90524	905242	50x15 mm	ZN	4	-	10	
	90525	905259	80x15 mm	ZN	4	-	10	

Acero



ZINCADO

Incluye tornillos en el blister

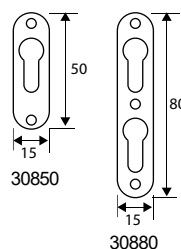

COLGADOR MUEBLE CG10

	Código	8431488	Medida	Acabado				€uros
Caja	30851	308517	48x13 mm	ZN	-	100	1000	
Blister	91121	911212	48x13 mm	ZN	4	-	10	

Acero



ZINCADO

Incluye tornillos en el blister

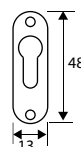

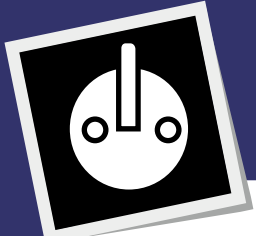

COLGADOR MUEBLE EMBUTIR CG22



	Código	8431488	Medida	Acabado				€uros
Caja	30858	308586	30 mm	ZN	-	25	250	
Blisters	92333	923338	30 mm	ZN	2	-	10	

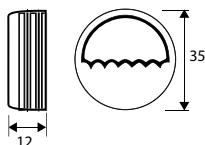

Zamak



ZINCADO

PLACA COLGADOR GALERÍA CG11



	Código	8431488	Medida Ax B	Acabado				€uros
Caja	30940	309408	40x18 mm	ZN	-	200	2000	
	30950	309507	50x18 mm	ZN	-	200	2000	
	30960	309606	60x18 mm	ZN	-	200	2000	
	30970	309705	70x20 mm	ZN	-	200	1000	
	30980	309804	80x20 mm	ZN	-	200	1000	
Blisters	90526	905266	40x18 mm	ZN	4	-	10	
	90527	905273	50x18 mm	ZN	4	-	10	
	90528	905280	60x18 mm	ZN	4	-	10	
	90529	905297	70x20 mm	ZN	4	-	10	
	90530	905303	80x20 mm	ZN	4	-	10	



Incluye tornillos en el blister

Acero



ZINCADO

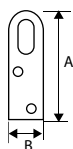

PLACA COLGADOR EXTINTOR CG14/CG15

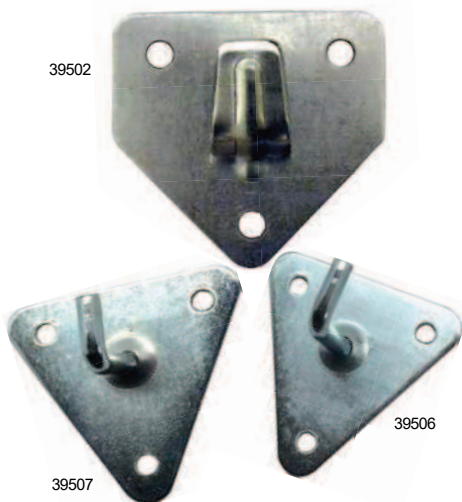

	Código	8431488	Kgs	Tipo	Acabado				€uros
Caja	39502	395029	6 Kgs	polvo1	ZN	-	25	125	
	39506	395067	2 Kgs	CO2	ZN	-	25	125	
	39507	395074	5 Kgs	CO2	ZN	-	25	125	
Blisters	91242	912424	6 Kgs	polvo1	ZN	1	-	10	

Acero



ZINCADO

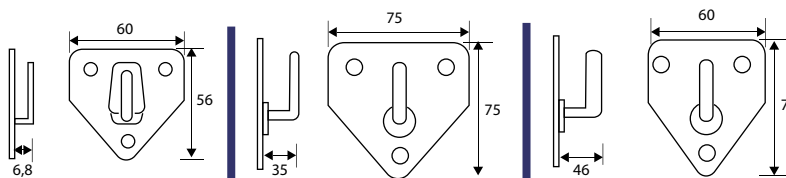

39502

39506

39507

COLGADOR CUADROS DENTADO CG19

	Código	8431488	Medida	Acabado				€uros
Caja	32006	320069	32x8 mm	LTD	-	100	1000	
Blister	91886	918860	32x8 mm	LTD	4	-	10	

Acero

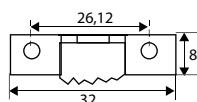

COLGADOR CUADROS TELA ENGOMADA CG18

	Código	8431488	Medida	Acabado				€uros
Caja	32003	320038	30 mm	BL	-	200	2000	
Blister	90885	908854	30 mm	BL	8	-	10	

Goma



GANCHO "X" CG13

	Código	8431488	Modelo	Acabado				€uros
Caja	32100	321004	Nº 0	LTD	-	100	1000	
	32101	321011	Nº 1	LTD	-	100	1000	
	32102	321028	Nº 2	LTD	-	100	1000	
Blister	90456	904566	Nº 0	LTD	10	-	10	
	90457	904573	Nº 1	LTD	10	-	10	
	90458	904580	Nº 2	LTD	10	-	10	

Acero



Presentación: caja de 10 uds con puntas

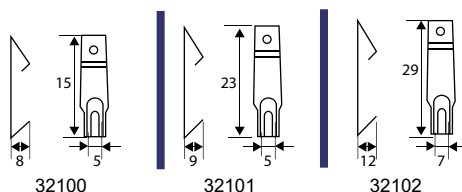

COLGADOR CUADROS CG12

	Código	8431488	Modelo	Acabado				€uros
Caja	32000	320007	Nº 0	LTD	-	100	2500	
	32001	320014	Nº 1	LTD	-	100	2500	
	32002	320021	Nº 2	LTD	-	100	2500	
Blister	90459	904597	Nº 0	LTD	10	-	10	
	90460	904603	Nº 1	LTD	10	-	10	
	90461	904610	Nº 2	LTD	10	-	10	

Acero



Incluye puntas en el blíster

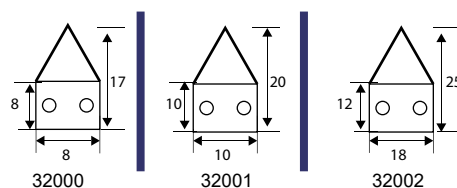

Te sugiero:

PUNTAS DE LATÓN
Pág. 189



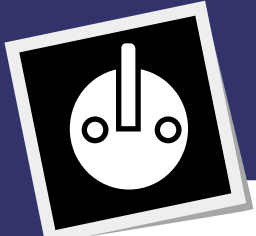

COLGADOR CUADROS CG16

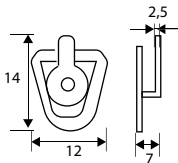

	Código	8431488	Tipo	Acabado				€uros
Blister	90872	908724	pequeño	BL	12	-	10	

Plástico



COLGADOR CUADROS CG17

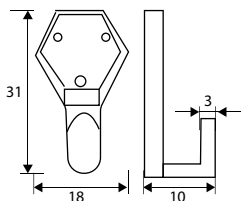

	Código	8431488	Tipo	Acabado				€uros
Blister	90873	908731	grande	BL	4	-	10	

Plástico



GANCHO FORMA "S" CG23



código	A	B	C
50325	25 mm	2,2 mm	5 mm
50330	30 mm	2,7 mm	6 mm
50335	35 mm	3,5 mm	7 mm
50340	40 mm	4,0 mm	9 mm
50350	50 mm	4,5 mm	9 mm
50360	60 mm	5,0 mm	8 mm
50370	70 mm	6,0 mm	8 mm
50380	80 mm	6,0 mm	9 mm

	Código	8431488	Medida A	Acabado				€uros
Caja	50325	503257	25 mm	ZN	-	100	2500	
	50330	503301	30 mm	ZN	-	100	2500	
	50335	503356	35 mm	ZN	-	100	2500	
	50340	503400	40 mm	ZN	-	100	1000	
	50350	503509	50 mm	ZN	-	100	500	
	50360	503608	60 mm	ZN	-	100	500	
	50370	503707	70 mm	ZN	-	100	300	
	50380	503806	80 mm	ZN	-	100	300	
Blister	90464	904641	25 mm	ZN	8	-	10	
	90465	904658	30 mm	ZN	6	-	10	
	90466	904665	35 mm	ZN	6	-	10	
	90467	904672	40 mm	ZN	6	-	10	
	90468	904689	50 mm	ZN	4	-	10	
	90469	904696	60 mm	ZN	4	-	10	
	90470	904702	70 mm	ZN	2	-	10	
	90471	904719	80 mm	ZN	2	-	10	

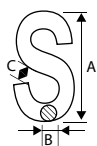

Acero



PLACA AMARRE REDONDA AP8

	Código	8431488	Medida A	Acabado				€uros
Caja	80062	800622	33 mm	INOX	-	5	125	
	80063	800639	40 mm	INOX	-	5	125	
	80064	800646	50 mm	INOX	-	5	50	
Blister	92354	923543	33 mm	INOX	2	-	10	
	92355	923550	40 mm	INOX	2	-	10	
	92356	923567	50 mm	INOX	2	-	10	

Acero Inoxidable AISI 316

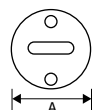

PLACA AMARRE REDONDA C/ANILLA AP9

	Código	8431488	Medida A	Acabado				€uros
Caja	80065	800653	33 mm	INOX	-	5	125	
	80066	800660	40 mm	INOX	-	5	125	
	80067	800677	50 mm	INOX	-	5	50	
Blister	92357	923574	33 mm	INOX	2	-	10	
	92358	923581	40 mm	INOX	2	-	10	
	92359	923598	50 mm	INOX	2	-	10	

Acero Inoxidable AISI 316



PLACA AMARRE OVAL AP10

	Código	8431488	Medida AxB	Acabado				€uros
Caja	80068	800684	45x17 mm	INOX	-	5	125	
	80069	800691	60x20 mm	INOX	-	5	125	
	80070	800707	80x26 mm	INOX	-	5	50	
Blister	92360	923604	45x17 mm	INOX	2	-	10	
	92361	923611	60x20 mm	INOX	2	-	10	
	92362	923628	80x26 mm	INOX	2	-	10	

Acero Inoxidable AISI 316

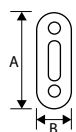

PLACA AMARRE OVAL C/ANILLA AP11

	Código	8431488	Medida AxB	Acabado				€uros
Caja	80071	800714	45x17 mm	INOX	-	5	125	
	80072	800721	60x20 mm	INOX	-	5	125	
	80073	800738	80x26 mm	INOX	-	5	50	
Blister	92363	923635	45x17 mm	INOX	2	-	10	
	92364	923642	60x20 mm	INOX	2	-	10	
	92365	923659	80x26 mm	INOX	2	-	10	

Acero Inoxidable AISI 316

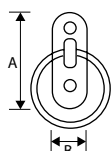

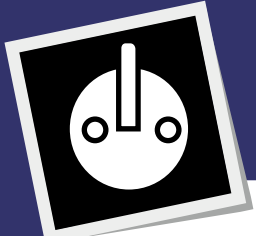

ANILLA SOLDADA C/HEMRILLA AP4



	Código	8431488	Medida	Acabado				€uros
Caja	80052	800523	65x50x9 mm	ZN	-	10	100	
	80053	800530	65x50x9 mm	NE	-	10	100	
Blister	92139	921396	65x50x9 mm	ZN	2	-	10	
	92165	921655	65x50x9 mm	NE	2	-	10	

Grosor anilla: 7 mm

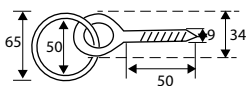

Acero
 ZINCADO NEGRO

GANCHO C/PLACA MÓVIL AP5



	Código	8431488	Medida	Acabado				€uros
Caja	80058	800585	70x45x7,5 mm	ZN	-	10	100	
	80059	800592	70x45x7,5 mm	NE	-	10	100	
Blister	92142	921426	70x45x7,5 mm	ZN	2	-	10	
	92168	921686	70x45x7,5 mm	NE	2	-	10	

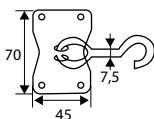

Acero
 ZINCADO NEGRO

ANILLA SOLDADA C/PLACA AP6



	Código	8431488	Medida	Acabado				€uros
Caja	80054	800547	70x45x50 mm	ZN	-	10	100	
	80055	800554	70x45x50 mm	NE	-	10	100	
Blister	92140	921402	70x45x50 mm	ZN	2	-	10	
	92166	921662	70x45x50 mm	NE	2	-	10	

Grosor anilla: 7 mm

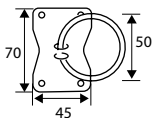

Acero
 ZINCADO NEGRO

GANCHO C/PLACA FIJO AP7



	Código	8431488	Medida	Acabado				€uros
Caja	80056	800561	45x45x55 mm	ZN	-	10	100	
	80057	800578	45x45x55 mm	NE	-	10	100	
Blister	92141	921419	45x45x55 mm	ZN	2	-	10	
	92167	921679	45x45x55 mm	NE	2	-	10	

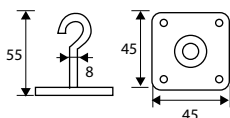

Acero
 ZINCADO NEGRO

ANILLA PLACA P/TOLDOS AP3

	Código	8431488	Medida	Acabado				€uros
Caja	80060	800608	45x25x5 mm	ZN	-	10	500	
	80061	800615	45x25x5 mm	INOX	-	10	250	
Blister	92131	921310	45x25x5 mm	ZN	2	-	10	
	92132	921327	45x25x5 mm	INOX	2	-	10	

ZN: Acero

INOX: Acero Inoxidable AISI 316



ZINCADO INOX

Incluye tornillos en el blister

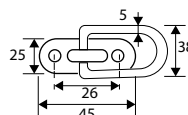

SOPORTE HAMACA ABIERTO AP1

	Código	8431488	Medida	Acabado				€uros
	80044	800448	100x100x5 mm	ZN	-	1	2	
	80045	800455	100x100x5 mm	BL	-	1	2	
	80050	800509	100x100x5 mm	NE	-	1	2	

Acero



ZINCADO BLANCO NEGRO

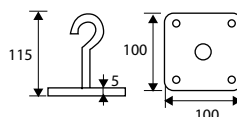

SOPORTE HAMACA CERRADO AP2

	Código	8431488	Medida	Acabado				€uros
	80046	800462	100x100x5 mm	ZN	-	1	2	
	80047	800479	100x100x5 mm	BL	-	1	2	
	80051	800516	100x100x5 mm	NE	-	1	2	

Acero



ZINCADO BLANCO NEGRO

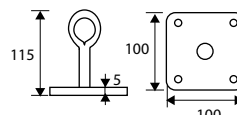

Te sugiero:

PLACA C/TUERCA
Pág. 317



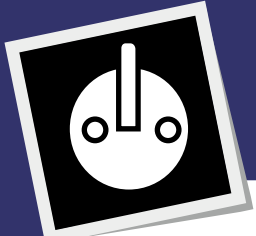

HEMBRILLA C/TUERCA ABIERTA HM2



	Código	8431488	Medida AxB	Acabado				€uros
Caja	80037	800370	M3x30 mm	ZN	-	100	3000	
	80038	800387	M4x30 mm	ZN	-	100	1000	
	80039	800394	M5x35 mm	ZN	-	100	1000	
	80040	800400	M6x50 mm	ZN	-	100	800	
	80041	800417	M8x60 mm	ZN	-	50	400	
	80042	800424	M10x70 mm	ZN	-	20	160	
	80043	800431	M12x80 mm	ZN	-	20	100	
	80080	800806	M3x30 mm	INOX	-	25	625	
	80081	800813	M4x40 mm	INOX	-	25	625	
	80082	800820	M5x50 mm	INOX	-	25	625	
	80083	800837	M6x60 mm	INOX	-	25	250	
80084	800844	M8x80 mm	INOX	-	25	250		
Blister	91248	912486	M3x30 mm	ZN	4	-	10	
	91249	912493	M4x30 mm	ZN	4	-	10	
	91250	912509	M5x35 mm	ZN	4	-	10	
	91251	912516	M6x50 mm	ZN	2	-	10	
	91252	912523	M8x60 mm	ZN	2	-	10	

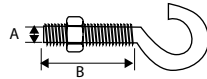

ZN: Acero
INOX: Acero Inoxidable

ZINCADO INOX

HEMBRILLA C/TUERCA SOLDADA HM1



	Código	8431488	Medida AxB	Acabado				€uros
Caja	80030	800301	M3x30 mm	ZN	-	100	3600	
	80031	800318	M4x30 mm	ZN	-	100	2400	
	80032	800325	M5x40 mm	ZN	-	100	1600	
	80033	800332	M6x50 mm	ZN	-	100	800	
	80048	800486	M6x100 mm	ZN	-	100	400	
	80034	800349	M8x60 mm	ZN	-	50	400	
	80049	800493	M8x100 mm	ZN	-	50	200	
	80035	800356	M10x70 mm	ZN	-	20	160	
	80036	800363	M12x80 mm	ZN	-	20	80	
	80074	800745	M3x30 mm	INOX	-	25	625	
	80075	800752	M4x40 mm	INOX	-	25	625	
	80076	800769	M5x50 mm	INOX	-	25	625	
	80077	800776	M6x60 mm	INOX	-	25	250	
	80078	800783	M8x80 mm	INOX	-	25	250	
80079	800790	M10x100 mm	INOX	-	10	100		
Blister	91243	912431	M3x30 mm	ZN	4	-	10	
	91244	912448	M4x30 mm	ZN	4	-	10	
	91245	912455	M5x40 mm	ZN	4	-	10	
	91246	912462	M6x50 mm	ZN	2	-	10	
	91247	912479	M8x60 mm	ZN	2	-	10	

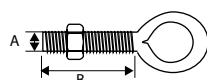

ZN: Acero
INOX: Acero Inoxidable

ZINCADO INOX

ALZAPAÑO TORNEADO PER19

	Código	8431488	Medida A	Acabado				€uros
Caja	50225	502250	25 mm	LT	-	100	500	
Blister	90463	904634	25 mm	LT	2	-	10	

Latón



LATÓN

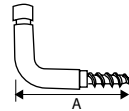

PERCHA EMBUTIR PER9

	Código	8431488	Medida	Acabado				€uros
Caja	28026	280264	80x20 mm	NS	-	4	100	

Zamak



NÍQUEL SATINADO

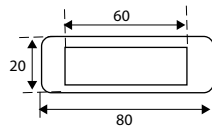

PERCHA EMBUTIR PER10

	Código	8431488	Medida	Acabado				€uros
Caja	28027	280271	140x16 mm	NS	-	4	96	

Zamak



NÍQUEL SATINADO

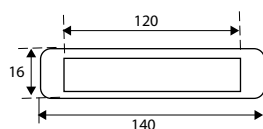

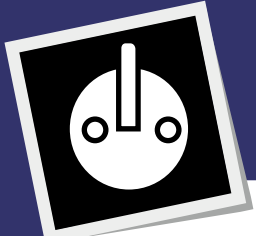

PERCHA RÚSTICA PER16

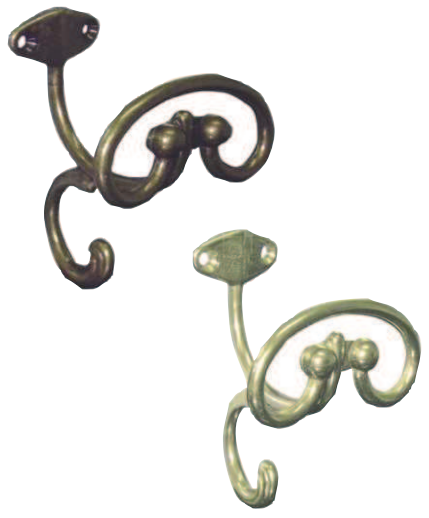

	Código	8431488	Medida	Acabado				€uros
Caja	28001	280011	108x75 mm	LE	-	4	20	
	28003	280035	108x75 mm	PE	-	4	20	
	28004	280042	108x75 mm	LP	-	4	20	

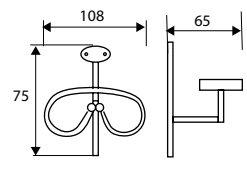

Zamak

LATÓN ENVEJECIDO
 PLATA ENVEJECIDA
 LATÓN PULIDO

PERCHA FORJA PER5



	Código	8431488	Medida	Acabado				€uros
Caja	28015	280158	70x70 mm	NE	-	4	40	

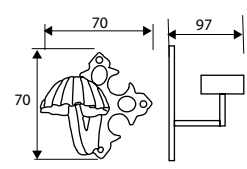

Zamak

NEGRO

PERCHA FORJA PER6



	Código	8431488	Medida	Acabado				€uros
Caja	28016	280165	70x70 mm	NE	-	4	40	

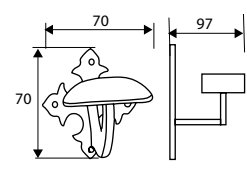

Zamak

NEGRO

PERCHA RÚSTICA PER17

	Código	8431488	Medida	Acabado				€uros
Caja	28011	280110	205x75 mm	LE	-	4	20	
	28013	280134	205x75 mm	PE	-	4	20	
	28014	280141	205x75 mm	LP	-	4	20	

Zamak

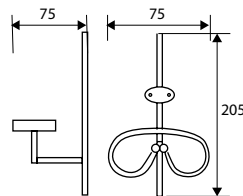

PERCHA FORJA PER7

	Código	8431488	Medida	Acabado				€uros
Caja	28017	280172	120X85 mm	NE	-	4	20	

Zamak

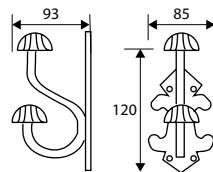

PERCHA FORJA PER8

	Código	8431488	Medida	Acabado				€uros
Caja	28018	280189	120X85 mm	NE	-	4	20	

Zamak

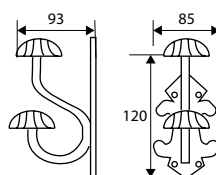

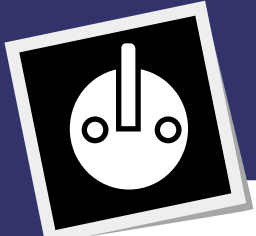

PERCHA SIMPLE PER12



	Código	8431488	Medida	Acabado				€uros
Caja	28030	280301	60x20 mm	INOX	-	4	100	
	28029	280295	79x20 mm	INOX	-	4	100	

Acero Inoxidable

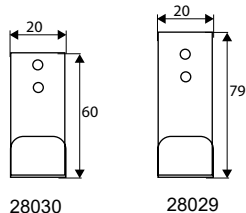

PERCHA DOBLE PER14



	Código	8431488	Medida	Acabado				€uros
Caja	28031	280318	90x20 mm	INOX	-	4	100	

Acero Inoxidable

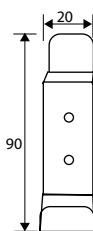

PERCHA DOBLE PER2



	Código	8431488	Medida	Acabado				€uros
Caja	28024	280240	170x42 mm	INOX	-	4	20	

Acero Inoxidable

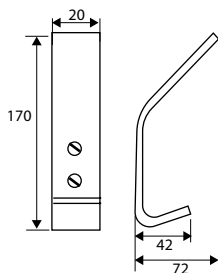

PERCHA CUADRADA PER11

	Código	8431488	Medida	Acabado				€uros
Caja	28028	280288	35x35 mm	INOX	-	4	100	



Acero Inoxidable

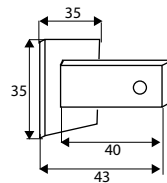

INOX



PERCHA REDONDA PER1

	Código	8431488	Medida	Acabado				€uros
Caja	28023	280233	32x50 mm	INOX	-	4	100	

Acero Inoxidable



INOX

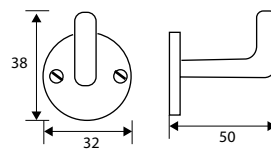

PERCHA 2 GANCHOS PER15

	Código	8431488	Medida	Acabado				€uros
Caja	28032	280325	185x72 mm	INOX	-	4	12	

Acero Inoxidable



INOX

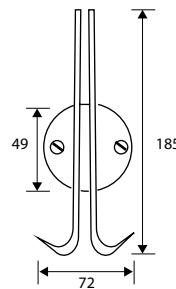

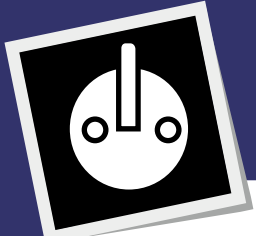

PERCHA PROBADOR PER3

	Código	8431488	Medida	Acabado				€uros
Caja	28025	280257	55x20 mm	INOX	-	4	100	

Acero Inoxidable

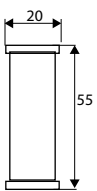

PERCHA TREBOL PER4

	Código	8431488	Medida	Acabado				€uros
Caja	28008	280080	80x65 mm	LTD	-	25	125	
	28009	280097	80x65 mm	ZN	-	25	125	
	28010	280103	80x65 mm	BL	-	25	125	

Zamak

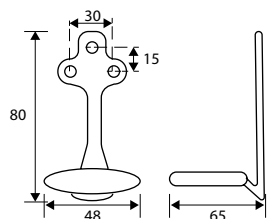





Te sugiero:

PERCHA C/TOPE GOMA PER18

Pág. 154





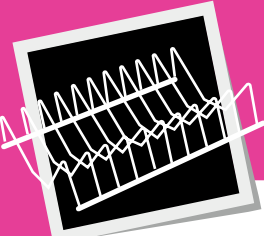

JGO ESCURREPLATO-VASO ECR1



Código	8431488	Módulo Ax B	Acabado				€uros
94940	949406	400x280 mm	INOX	-	1	-	
94945	949451	450x280 mm	INOX	-	1	-	
94950	949505	500x280 mm	INOX	-	1	-	
94960	949604	600x280 mm	INOX	-	1	-	
94970	949703	700x280 mm	INOX	-	1	-	
94980	949802	800x280 mm	INOX	-	1	-	
94990	949901	900x280 mm	INOX	-	1	-	
94910	949109	1000x280 mm	INOX	-	1	-	

Contenido del juego:
1 escurreplatos, 1 escurrevasos y 1 bandeja

Acero Inoxidable

INOX

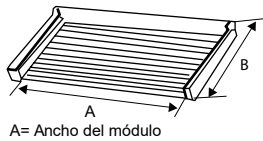

JGO ESCURREPLATO-VASO ECR2



Código	8431488	Módulo Ax B	Acabado				€uros
94440	944401	400x230 mm	BL	-	1	-	
94445	944456	450x230 mm	BL	-	1	-	
94450	944500	500x230 mm	BL	-	1	-	
94460	944609	600x230 mm	BL	-	1	-	
94470	944708	700x230 mm	BL	-	1	-	
94480	944807	800x230 mm	BL	-	1	-	
94490	944906	900x230 mm	BL	-	1	-	
94410	944104	1000x230 mm	BL	-	1	-	
94360	943602	600x230 mm	CB	-	1	-	
94370	943701	700x230 mm	CB	-	1	-	
94380	943800	800x230 mm	CB	-	1	-	
94390	943909	900x230 mm	CB	-	1	-	

Incluye regletas - No incluye bandeja

Acero

BLANCO CROMO BRILLO

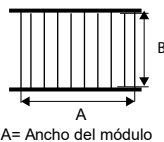

ESCURREPLATOS ACOPLABLE ECR5

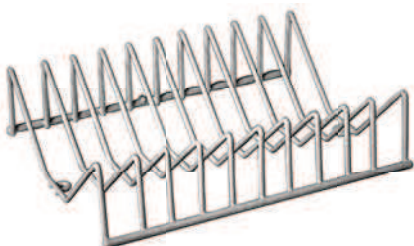

Código	8431488	Medida	Acabado				€uros
94402	944029	250 mm	BL	-	1	-	
94403	944036	250 mm	CB	-	1	-	

Para acoplar en el escurrevasos ECR4

Acero Recubierto PVC

BLANCO CROMO BRILLO

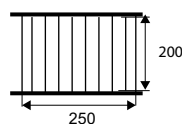

ESCURREPLATOS ECR3

Código	8431488	Módulo AxB	Acabado				€uros
94640	946405	400x230 mm	BL	-	1	-	
94645	946450	450x230 mm	BL	-	1	-	
94650	946504	500x230 mm	BL	-	1	-	
94660	946603	600x230 mm	BL	-	1	-	
94670	946702	700x230 mm	BL	-	1	-	
94680	946801	800x230 mm	BL	-	1	-	
94690	946900	900x230 mm	BL	-	1	-	
94610	946108	1000x230 mm	BL	-	1	-	
94560	945606	600x230 mm	CB	-	1	-	
94570	945705	700x230 mm	CB	-	1	-	
94580	945804	800x230 mm	CB	-	1	-	
94590	945903	900x230 mm	CB	-	1	-	

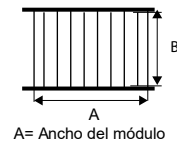
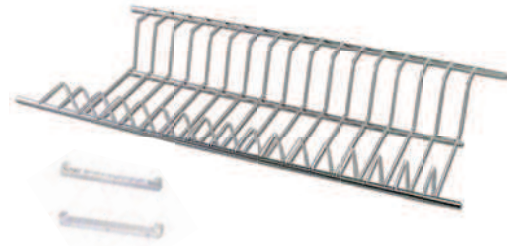

Acero



Incluye regletas

ESCURREVASOS ECR4

Código	8431488	Módulo AxB	Acabado				€uros
94840	948409	400x230 mm	BL	-	1	-	
94845	948454	450x230 mm	BL	-	1	-	
94850	948508	500x230 mm	BL	-	1	-	
94860	948607	600x230 mm	BL	-	1	-	
94870	948706	700x230 mm	BL	-	1	-	
94880	948805	800x230 mm	BL	-	1	-	
94890	948904	900x230 mm	BL	-	1	-	
94810	948102	1000x230 mm	BL	-	1	-	
94760	947600	600x230 mm	CB	-	1	-	
94770	947709	700x230 mm	CB	-	1	-	
94780	947808	800x230 mm	CB	-	1	-	
94790	947907	900x230 mm	CB	-	1	-	

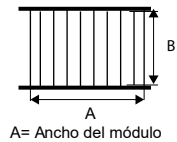

Acero



Incluye regletas

BANDEJA VIERTEGUAS ECR7

Código	8431488	Módulo AxB	Acabado				€uros
94404	944043	450x245 mm	BL	-	1	20	
94405	944050	500x245 mm	BL	-	1	20	
94406	944067	600x245 mm	BL	-	1	20	
94407	944074	700x245 mm	BL	-	1	20	
94408	944081	800x245 mm	BL	-	1	20	
94409	944098	900x245 mm	BL	-	1	20	

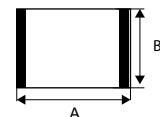

ABS



Incluye regletas

SUJECIONES ECR6

Código	8431488	Tipo	Acabado				€uros
Caja	94400	regleta	BL	-	24	240	
	94401	pivote	BL	-	50	500	

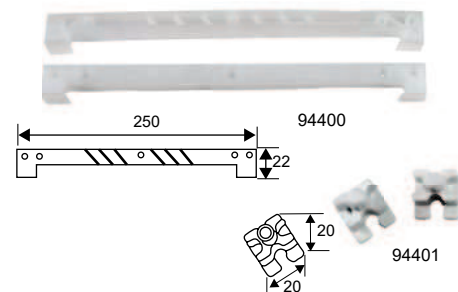

ABS



Precio individual

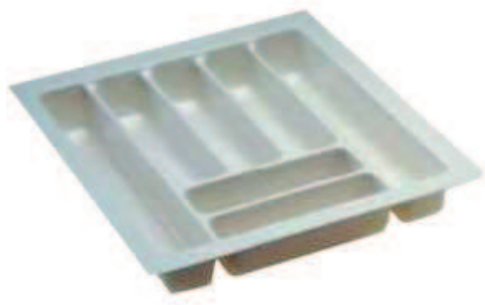
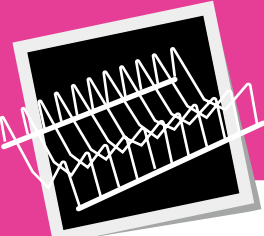

CUBERTERO CBT1

Código	8431488	Módulo/Medida	Acabado				€uros
94130	941301	300/235x480 mm	GR	-	1	-	
94135	941356	350/285x480 mm	GR	-	1	-	
94140	941400	400/335x480 mm	GR	-	1	-	
94145	941455	450/385x480 mm	GR	-	1	-	
94150	941509	500/435x480 mm	GR	-	1	-	
94160	941608	600/535x480 mm	GR	-	1	-	
94161	941615	700/635x480 mm	GR	-	1	-	
94162	941622	800/735x480 mm	GR	-	1	-	
94163	941639	900/835x480 mm	GR	-	1	-	
94164	941646	1000/935x480 mm	GR	-	1	-	
94165	941653	1200/1135x480 mm	GR	-	1	-	
94230	942308	300/235x480 mm	BL	-	1	-	
94235	942353	350/285x480 mm	BL	-	1	-	
94240	942407	400/335x480 mm	BL	-	1	-	
94245	942452	450/385x480 mm	BL	-	1	-	
94250	942506	500/435x480 mm	BL	-	1	-	
94260	942605	600/535x480 mm	BL	-	1	-	

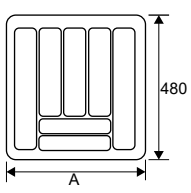

ABS
 GRIS
 BLANCO



ESTERILLA ANTIDESLIZANTE DZ12

Código	8431488	Medida	Acabado				€uros
<i>Blister</i>	94175	941752	480 mmx1,5 mts	GR	1	-	25

Espesor 1,5 mm

PVC
 GRIS



ESTERILLA ANTIDESLIZANTE DZ11

Código	8431488	Medida	Acabado				€uros
	94111	941110	480 mmx20 mts	GR	-	1	-

Espesor 1,5 mm

PVC
 GRIS

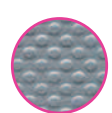

REJILLA VENTILACIÓN FRIGO-HORNO RJV1

	Código	8431488	Elementos	Acabado				€uros
Blister	94511	945118	8 elementos	BL	1	-	25	
	94512	945125	8 elementos	EI	1	-	25	
	94513	945132	8 elementos	NE	1	-	25	
	94514	945149	8 elementos	INOX	1	-	25	

Aluminio

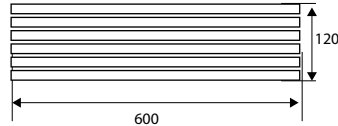

MARCO MICROONDAS MCR1

	Código	8431488	Medida	Acabado				€uros
	94505	945057	600x400 mm	BL	-	1	12	
	94506	945064	600x400 mm	INOX	-	1	12	
	94507	945071	600x400 mm	NE	-	1	12	
	94508	945088	600x400 mm	EI	-	1	12	

ABS

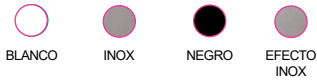

Autocortable

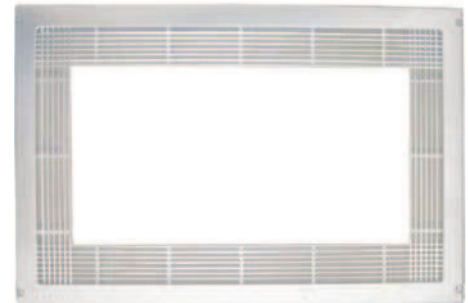
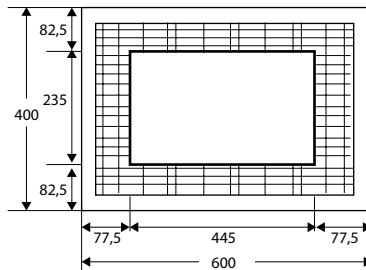

94505

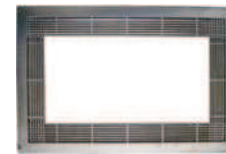

94506



94507



94508

SOPORTE MICROONDAS MCR2

	Código	8431488	Peso	Acabado				€uros
Caja	80451	804514	40 Kgs	BL	-	1	11	
	80452	804521	40 Kgs	GR	-	1	11	

Acero



Extensible 320-485 mm

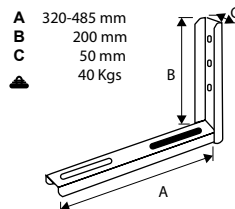

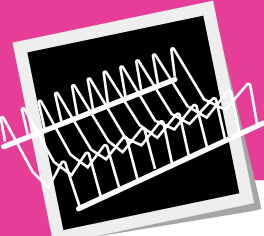

COPETE CLASSIC CPT1



	Código	8431488	Medida	Acabado				€uros
	94117	941172	4 mts	AL	-	5	-	
	94118	941189	4 mts	BL	-	5	-	
	94119	941196	4 mts	NE	-	5	-	

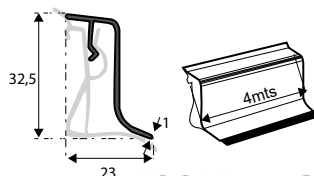

Aluminio



ESQUINA COPETE CLASSIC CPT1



	Código	8431488	Medida	Acabado				€uros
Caja	94123	941233	40x40 mm	AL	-	25	125	
	94124	941240	40x40 mm	BL	-	25	125	
	94125	941257	40x40 mm	NE	-	25	125	
Blister	91103	911038	40x40 mm	AL	2	-	10	
	91104	911045	40x40 mm	BL	2	-	10	
	91105	911052	40x40 mm	NE	2	-	10	

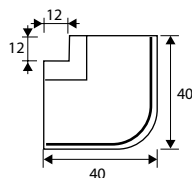

PVC



RINCÓN COPETE CLASSIC CPT1



	Código	8431488	Medida	Acabado				€uros
Caja	94120	941202	40x40 mm	AL	-	25	125	
	94121	941219	40x40 mm	BL	-	25	125	
	94122	941226	40x40 mm	NE	-	25	125	
Blister	91109	911090	40x40 mm	AL	2	-	10	
	91110	911106	40x40 mm	BL	2	-	10	
	91111	911113	40x40 mm	NE	2	-	10	

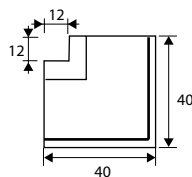

PVC



TAPA COPETE CLASSIC CPT1



	Código	8431488	Mano	Acabado				€uros
Caja	94126	941264	derecha	AL	-	25	625	
	94127	941271	izquierda	AL	-	25	625	
	94128	941288	derecha	BL	-	25	625	
	94129	941295	izquierda	BL	-	25	625	
	94131	941318	derecha	NE	-	25	625	
	94132	941325	izquierda	NE	-	25	625	
Blister	91115	911151	dcha/izda	AL	1+1	-	10	
	91116	911168	dcha/izda	BL	1+1	-	10	
	91117	911175	dcha/izda	NE	1+1	-	10	

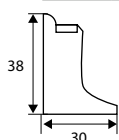

PVC



COPETE ROUND CPT2

	Código	8431488	Medida	Acabado				€uros
	94133	941332	4 mts	AL	-	5	-	
	94134	941349	4 mts	BL	-	5	-	

Aluminio

ALUMINIO BLANCO

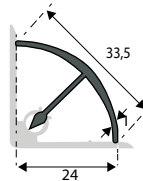

ESQUINA COPETE ROUND CPT2

	Código	8431488	Medida	Acabado				€uros
Caja	94141	941417	40x40 mm	AL	-	25	125	
	94142	941424	40x40 mm	BL	-	25	125	
Blister	91106	911069	40x40 mm	AL	2	-	10	
	91107	911076	40x40 mm	BL	2	-	10	

PVC

ALUMINIO BLANCO

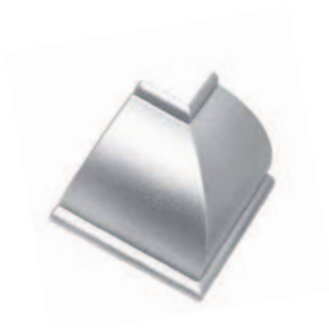
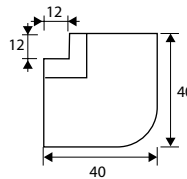
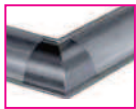

RINCÓN COPETE ROUND CPT2

	Código	8431488	Tipo	Acabado				€uros
Caja	94137	941370	40x40 mm	AL	-	25	125	
	94138	941387	40x40 mm	BL	-	25	125	
Blister	91112	911120	40x40 mm	AL	2	-	10	
	91113	911137	40x40 mm	BL	2	-	10	

PVC

ALUMINIO BLANCO

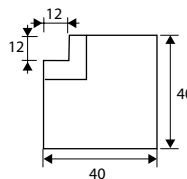

TAPA COPETE ROUND CPT2

	Código	8431488	Medida	Acabado				€uros
Caja	94144	941448	30x30 mm	AL	-	25	625	
	94146	941462	30x30 mm	BL	-	25	625	
Blister	91118	911182	30x30 mm	AL	2	-	10	
	91119	911199	30x30 mm	BL	2	-	10	

PVC

ALUMINIO BLANCO



No guarda mano

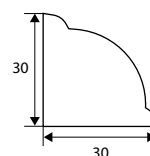

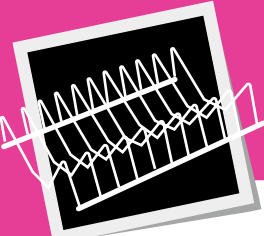

TAPA ENCIMERA ENC1

	Código	8431488	Medida	Acabado				€uros
Blister	94149	941493	650x30 mm	AL	1	-	25	
	94151	941516	650x30 mm	BL	1	-	25	
	94152	941523	650x30 mm	NE	1	-	25	

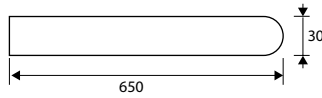

Aluminio

ALUMINIO
 BLANCO
 NEGRO



UNIÓN ENCIMERA ENC2

	Código	8431488	Medida	Acabado				€uros
Blister	94153	941530	650x30 mm	AL	1	-	25	
	94154	941547	650x30 mm	BL	1	-	25	
	94155	941554	650x30 mm	NE	1	-	25	

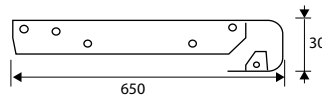

Aluminio

ALUMINIO
 BLANCO
 NEGRO



EXTENSIÓN ENCIMERA ENC3

	Código	8431488	Medida	Acabado				€uros
Blister	94156	941561	650x30 mm	AL	1	-	25	
	94157	941578	650x30 mm	BL	1	-	25	
	94158	941585	650x30 mm	NE	1	-	25	

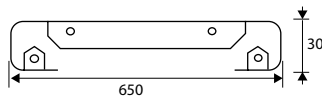

Aluminio

ALUMINIO
 BLANCO
 NEGRO



TAPA ENCIMERA ENC4

	Código	8431488	Medida	Acabado				€uros
Blister	94188	941882	650x40 mm	AL	1	-	25	

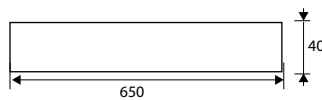

Aluminio

ALUMINIO



UNIÓN ENCIMERA ENC5

	Código	8431488	Medida	Acabado				€uros
Blister	94189	941899	650x40 mm	AL	1	-	25	



Aluminio

ALUMINIO



EXTENSIÓN ENCIMERA ENC6

	Código	8431488	Medida	Acabado				€uros
Blister	94190	941905	650x40 mm	AL	1	-	25	

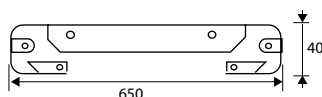

Aluminio

ALUMINIO

PROTECTOR VITROCERÁMICA/GAS PTR5

	Código	8431488	Tipo/Medida AxBxC	Acabado				€uros
Caja	94183	941837	Vitro/605x525x29 mm	INOX	-	1	-	
	94184	941844	Gas/605x525x58 mm	INOX	-	1	-	

Acero Inoxidable

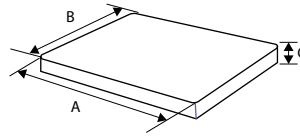

SALVA ENCIMERA PTR6

	Código	8431488	Tipo/ Medida	Acabado				€uros
	94185	941851	Plano/470x315 mm	INOX	-	1	-	
	94186	941868	Curvo/470x315 mm	INOX	-	1	-	

Acero Inoxidable

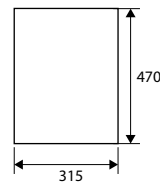

PROTECTOR COSTADO FRIGO PTR4

	Código	8431488	Tablero	Acabado				€uros
	94182	941820	19 mm	INOX	-	1	10	

Acero Inoxidable

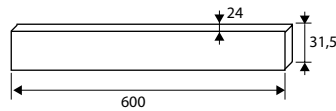

PROTECTOR COSTADO FRIGO PTR3

	Código	8431488	Tablero	Acabado				€uros
	94172	941721	19 mm	EI	-	1	10	

PVC

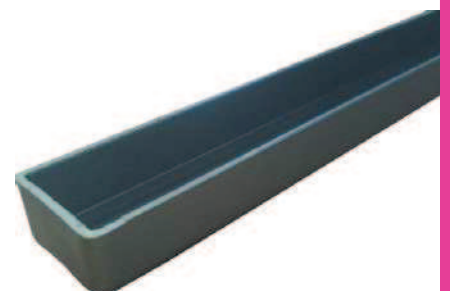
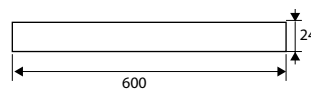

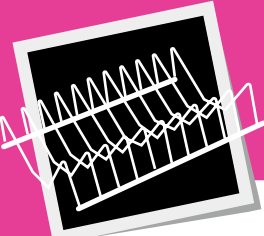

ZÓCALO PVC ZCL2

Código	8431488	Medida	Acabado				€uros
94159	941592	144x4 mts	AL	-	1	10	

Incluye goma

PVC

ALUMINIO

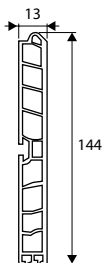
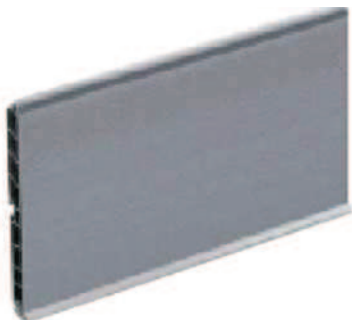

ZÓCALO ALUMINIO ZCL1

Código	8431488	Medida	Acabado				€uros
94148	941486	144x4 mts	AL	-	1	10	

Incluye goma

Aluminio

ALUMINIO

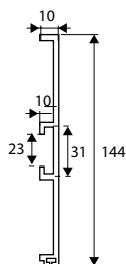

RINCÓN ZÓCALO ZCL3/ZCL4

Código	8431488	Medida	Tipo				€uros
94174	941745	144 mm	AL	-	10	100	
94176	941769	144 mm	AL	-	10	100	

Regulable

94174: Aluminio - ZCL4

94176: PVC - ZCL3

ALUMINIO

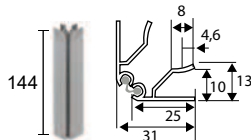

94174

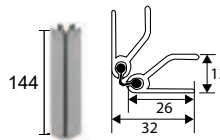

94176

PROTECTOR ZÓCALO MADERA PTR7

Código	8431488	Medida	Acabado				€uros
94173	941738	19 mm	TR	-	5	-	

No incluye zócalo

PVC

TRANSPARENTE

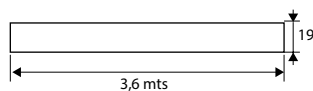
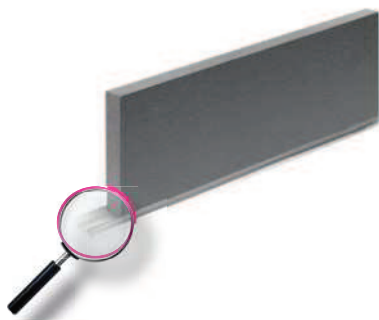

PROTECTOR FONDO FREGADERO PTR1

Código	8431488	Medida AxB	Acabado				€uros
	94112	941127	500x580 mm	AL	-	10	-
	94113	941134	600x580 mm	AL	-	10	-
	94114	941141	700x580 mm	AL	-	10	-
	94115	941158	800x580 mm	AL	-	10	-
	94116	941165	900x580 mm	AL	-	10	-
	94187	941875	1000x580 mm	AL	-	10	-

Aluminio

Incluye goma

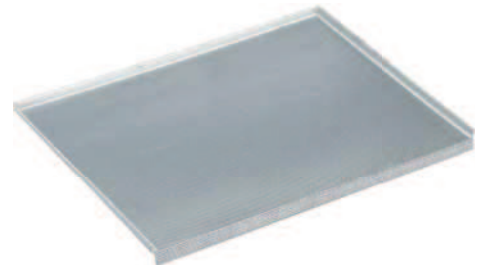

ALUMINIO

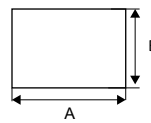

JGO GRAPA SUJECIÓN FREGADERO GRP3/GRP4

Código	8431488	Medida	Acabado				€uros
	94191	941912	50x18 mm	NI	-	1	5
	94192	941929	47x18 mm	NI	-	1	5
<i>Blister</i>	92410	924106	50x18 mm	NI	1	-	10
	92411	924113	47x18 mm	NI	1	-	10

Acero

1 juego = 6 unidades



NIQUEL

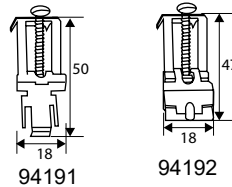

94191



94192

BURLETE FREGADERO BLT12

Código	8431488	Medida	Acabado				€uros
	94193	941936	2x2,8 mm	GR	-	5	50
<i>Blister</i>	92412	924120	2x2,8 mm	GR	1	-	10

Caucho



GRIS

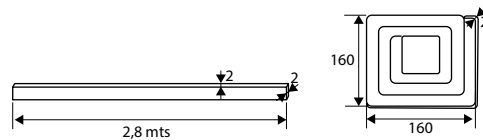

JGO PROTECTOR CAMPANA PTR2

Código	8431488	Medida AxB	Acabado				€uros
	94170	941707	235x330 mm	INOX	-	1	10
	94171	941714	235x330 mm	BL	-	1	10

94170: Acero Inoxidable

94171: Aluminio



INOX BLANCO

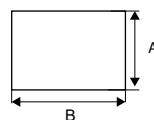

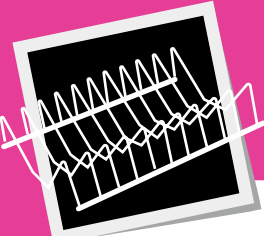

PIVOTE SUJETA CAMPANA PVT1



	Código	8431488	Medida	Acabado				€uros
Caja	31401	314013	9,5x17x5 mm	ZN	-	25	625	
Blister	91325	913254	9,5x17x5 mm	ZN	2	-	10	

Incluye goma

Acero

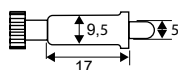

ZINCADO

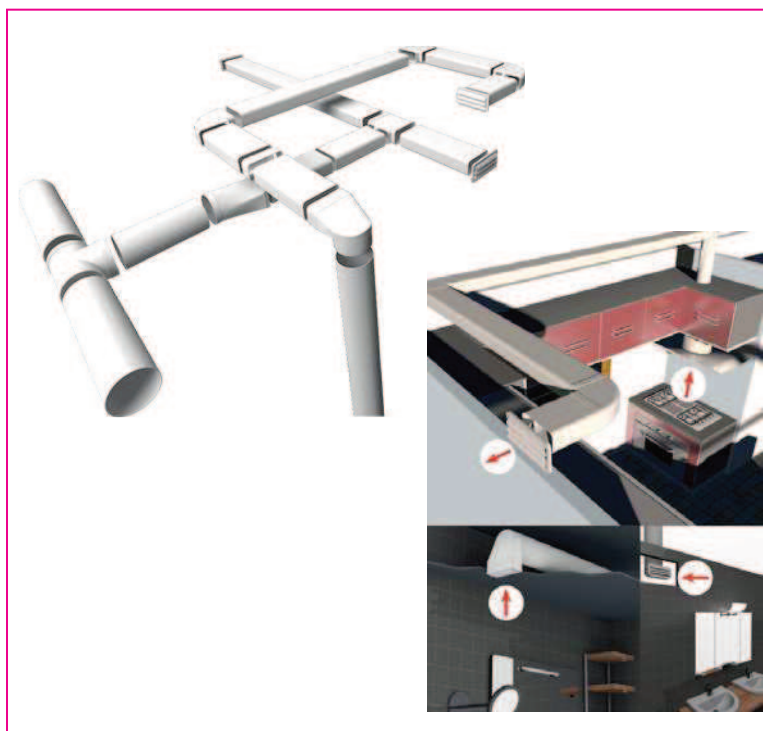

Ø 100 mm – 110 x 55 mm

Recomendada para campanas extractoras de ≤ 400 m³/h (equivalente extracción 100 mm). Permite la perfecta integración en falsos techos y cornisas de los muebles de cocina con un hueco mínimo de 6 cm entre techo y cornisa (tubo rectangular).

Ø 120 mm – 147 x 70 mm

Recomendada para campanas extractoras de 400 a 600 m³/h (equivalente extracción 120 - 125 mm). Permite la perfecta integración en falsos techos y cornisas de los muebles de cocina con un hueco mínimo de 8 cm entre techo y cornisa (tubo rectangular). Disminución de la sonoridad de la campana a bajo y alto rendimiento.

Ø 150 mm – 170 x 90 mm

Recomendada para campanas extractoras de una evacuación de ≥ 600 m³/h (equivalente extracción 150 mm). Permite la perfecta integración en falsos techos y cornisas de los muebles de cocina. Disminución de la sonoridad de la campana a bajo y alto rendimiento.

TUBO REDONDO VN2



	Código	8431488	Medida Ø x A	Acabado				€uros
	89024	890241	Ø100 mmx1,5 mts	BL	-	1	12	
	89048	890487	Ø120 mmx1,5 mts	BL	-	1	8	
	89073	890739	Ø150 mmx1,5 mts	BL	-	1	8	

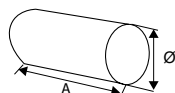

PVC



BLANCO

TUBO RECTANGULAR VN1



	Código	8431488	Medida \square x A x B	Acabado				€uros
	89023	890234	\square 110x55 mmx1,5 mts	BL	-	1	16	
	89047	890470	\square 147x70 mmx1,5 mts	BL	-	1	12	
	89072	890722	\square 170x90 mmx1,5 mts	BL	-	1	8	

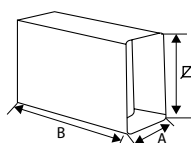

PVC



BLANCO

ARO REDUCTOR VN3

Código	8431488	Medida	Acabado				€uros
89025	890258	Ø125-100 mm	BL	-	1	50	
89049	890494	Ø125-120 mm	BL	-	1	30	
89063	890630	Ø150-120 mm	BL	-	1	30	

PVC

BLANCO

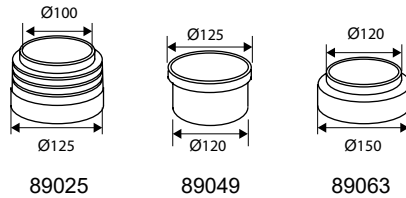

EMPALME REDONDO VN4

Código	8431488	Medida Ø A	Acabado				€uros
89026	890265	Ø100 mm	BL	-	1	50	
89050	890500	Ø120 mm	BL	-	1	30	
89074	890746	Ø150 mm	BL	-	1	15	

PVC

BLANCO

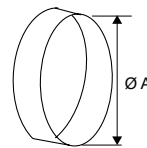

EMPALME RECTANGULAR VN5

Código	8431488	Medida ∇ A x B	Acabado				€uros
89027	890272	∇ 110x55 mm	BL	-	1	50	
89051	890517	∇ 147x70 mm	BL	-	1	30	
89075	890753	∇ 170x90 mm	BL	-	1	15	

PVC

BLANCO

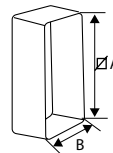

EMPALME MIXTO VN6

Código	8431488	Medida ∇ A x ∇ B x C	Acabado				€uros
89028	890289	Ø100x ∇ 110x55 mm	BL	-	1	50	
89052	890524	Ø120x ∇ 147x70 mm	BL	-	1	30	
89076	890760	Ø150x ∇ 170x90 mm	BL	-	1	15	

PVC

BLANCO

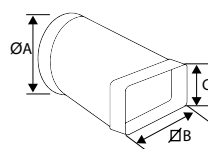

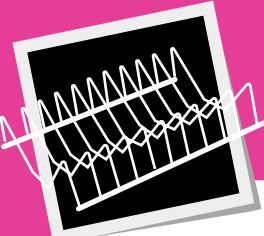

CODO 45° REDONDO VN7



Código	8431488	Medida Ø	Acabado				€uros
89064	890647	Ø100 mm	BL	-	1	50	
89066	890661	Ø120 mm	BL	-	1	30	

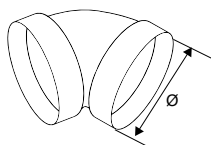

PVC



BLANCO

CODO 45° RECTANGULAR HORIZONTAL VN8

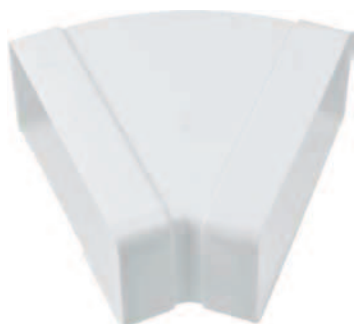

Código	8431488	Medida ∇ A x B	Acabado				€uros
89065	890654	∇ 110x55 mm	BL	-	1	50	
89067	890678	∇ 147x70 mm	BL	-	1	30	

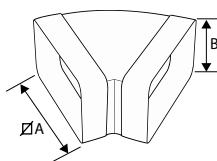

PVC



BLANCO

CODO 90° REDONDO VN9



Código	8431488	Medida Ø	Acabado				€uros
89029	890296	Ø100 mm	BL	-	1	30	
89053	890531	Ø120 mm	BL	-	1	10	
89077	890777	Ø150 mm	BL	-	1	12	

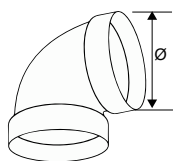

PVC



BLANCO

ABRAZADERA REDONDA VN13

Código	8431488	Medida Ø	Acabado				€uros
89037	890371	Ø100 mm	BL	-	1	50	
89061	890616	Ø120 mm	BL	-	1	30	

PVC

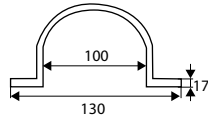

89037

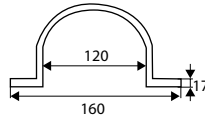

89061



ABRAZADERA RECTANGULAR VN14

Código	8431488	Medida \square A x B	Acabado				€uros
89038	890388	Ø110x55 mm	BL	-	1	50	
89062	890623	Ø147x70 mm	BL	-	1	30	

PVC

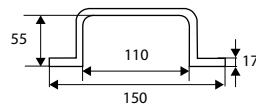

89038

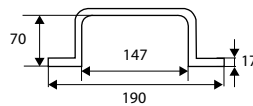

89062



EMBELLECEDOR REDONDO VN15

Código	8431488	Medida Ø	Acabado				€uros
89035	890357	Ø100 mm	BL	-	1	50	
89059	890593	Ø120 mm	BL	-	1	30	

PVC

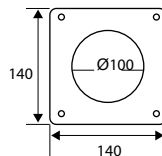

89035

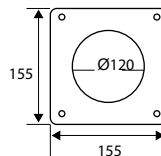

89059

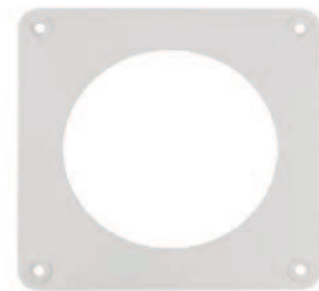

EMBELLECEDOR RECTANGULAR VN16

Código	8431488	Medida \square A x B	Acabado				€uros
89036	890364	Ø110x55 mm	BL	-	1	50	
89060	890609	Ø147x70 mm	BL	-	1	30	

PVC

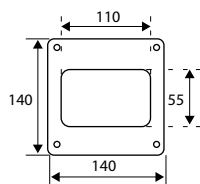

89036

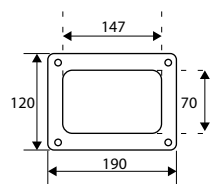

89060



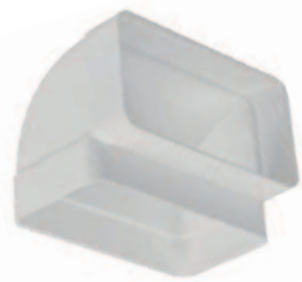
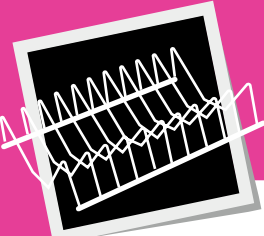

CODO 90° VERTICAL VN10

Código	8431488	Medida ∇ A x B	Acabado				€uros
89031	890319	∇ 110x55 mm	BL	-	1	50	
89055	890555	∇ 147x70 mm	BL	-	1	10	
89079	890791	∇ 170x90 mm	BL	-	1	15	

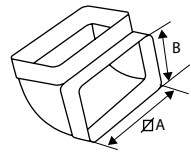

PVC
BLANCO



CODO 90° HORIZONTAL VN11

Código	8431488	Medida ∇ A x B	Acabado				€uros
89032	890326	∇ 110x55 mm	BL	-	1	50	
89056	890562	∇ 147x70 mm	BL	-	1	10	
89080	890807	∇ 170x90 mm	BL	-	1	15	

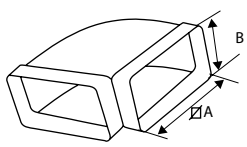

PVC
BLANCO



CODO 90° MIXTO VN12

Código	8431488	Medida $\text{A}\varnothing$ x B ∇ x C	Acabado				€uros
89030	890302	\varnothing 100x ∇ 110x55 mm	BL	-	1	50	
89054	890548	\varnothing 120x ∇ 147x70 mm	BL	-	1	10	
89078	890784	\varnothing 150x ∇ 170x90 mm	BL	-	1	15	

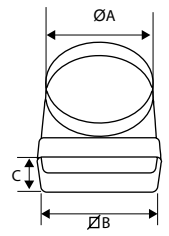

PVC
BLANCO

VENTANILLA SALIDA REDONDA VN17

Código	8431488	Medida Ø	Acabado				€uros
89033	890333	Ø100 mm	BL	-	1	50	
89057	890579	Ø120 mm	BL	-	1	30	

PVC



BLANCO

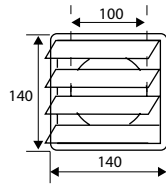

89033

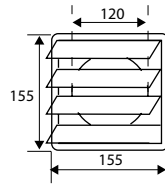

89057



VENTANILLA SALIDA RECTANGULAR VN18

Código	8431488	Medida ∇ A x B	Acabado				€uros
89034	890340	∇ 110x55 mm	BL	-	1	50	
89058	890586	∇ 147x70 mm	BL	-	1	30	

PVC



BLANCO

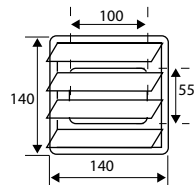

89034

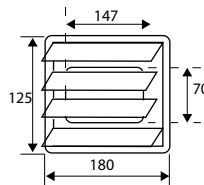

89058

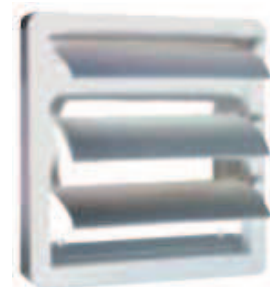

VENTANILLA MIXTA VN19

Código	8431488	Medida	Acabado				€uros
89081	890814	Ø150/ ∇ 170x90 mm	BL	-	1	15	

PVC



BLANCO



Válido para tubo redondo y rectangular

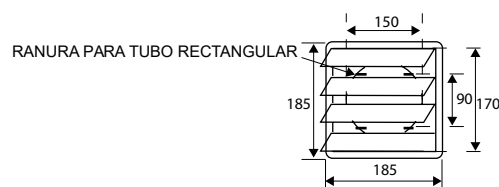

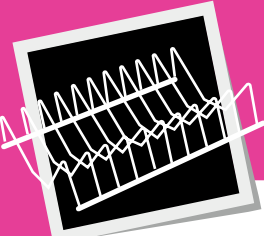

REJILLA EMPOTRAR RJV3

Código	8431488	Medida AxB	Acabado				€uros
89003	890036	160x160 mm	BL	-	1	100	
89002	890029	160x160 mm	AL	-	1	100	
89001	890012	120x240 mm	BL	-	1	80	

Espesor 0,6 mm

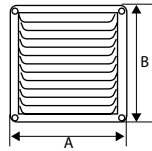

Aluminio



REJILLA PLANA RJV2



Código	8431488	Medida AxB	Acabado				€uros
89006	890067	150x300 mm	BL	-	1	125	
89007	890074	150x300 mm	NO	-	1	150	
89005	890050	150x300 mm	AL	-	1	150	
89011	890111	150x150 mm	BL	-	1	100	
89014	890142	150x150 mm	NO	-	1	100	
89008	890081	150x150 mm	AL	-	1	100	
89012	890128	170x170 mm	BL	-	1	100	
89015	890159	170x170 mm	NO	-	1	100	
89009	890098	170x170 mm	AL	-	1	100	
89013	890135	200x200 mm	BL	-	1	100	
89016	890166	200x200 mm	NO	-	1	100	
89010	890104	200x200 mm	AL	-	1	100	

Espesor 0,6 mm

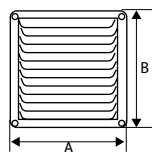

Aluminio



REJILLA MOSQUITERA RJV4



Código	8431488	Medida AxB	Acabado				€uros
89039	890395	150x150 mm	AL	-	1	25	
89042	890425	150x150 mm	BL	-	1	25	
89040	890401	170x170 mm	AL	-	1	25	
89043	890432	170x170 mm	BL	-	1	25	
89041	890418	200x200 mm	AL	-	1	25	
89044	890449	200x200 mm	BL	-	1	25	

Espesor 0,6 mm

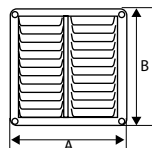

Aluminio





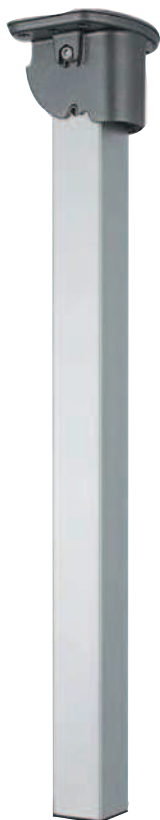

96016



96017



96021



PATA MESA PLEGABLE PT7

Código	8431488	Medida	Acabado				€uros
96016	960166	710x50 mm	RAL9006	-	1	4	

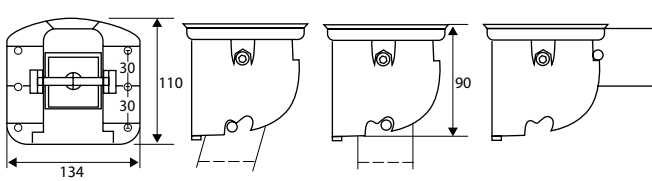

Acero



RAL9006

PATA MESA PLEGABLE PT8

Código	8431488	Medida	Acabado				€uros
96017	960173	710x50 mm	RAL9006	-	1	4	

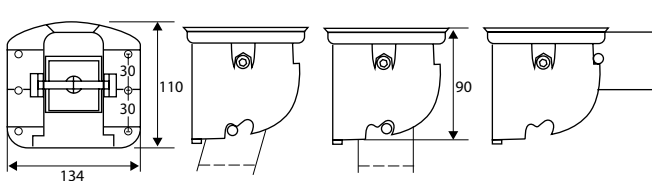

Acero



RAL9006

PATA MESA PLEGABLE PT5

Código	8431488	Medida	Acabado				€uros
96021	960210	710x50 mm	CB	-	1	4	
96022	960227	710x50 mm	NS	-	1	4	

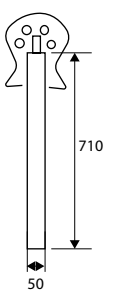

Acero



CROMO BRILLO



NÍQUEL SATINADO



REGULABLE DE 0 A 30 mm

PATA MESA PLEGABLE/REGULABLE PT9

Código	8431488	Medida	Acabado				€uros
96018	960180	710x50 mm	RAL9006	-	1	4	

Acero

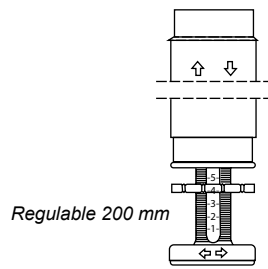
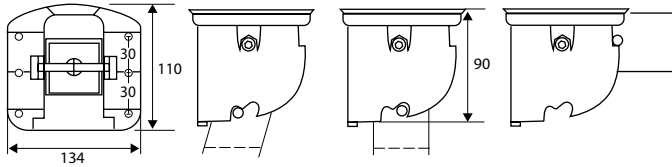

96018

PATA MESA REGULABLE PT10

Código	8431488	Medida	Acabado				€uros
96019	960197	710x60 mm	RAL9006	-	1	4	

Acero

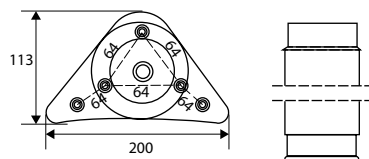

Regulable 200 mm

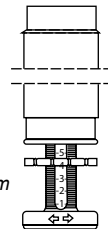

96019



PATA MESA Ø60 MM PT6



Código	8431488	Medida AxB	Acabado				€uros
96001	960012	710x60 mm	BL	-	4	-	
96002	960029	710x60 mm	NE	-	4	-	
96003	960036	710x60 mm	CB	-	4	-	
96004	960043	710x60 mm	NS	-	4	-	
96005	960050	710x60 mm	RAL9006	-	4	-	
96011	960111	830x60 mm	BL	-	4	-	
96012	960128	830x60 mm	NE	-	4	-	
96013	960135	830x60 mm	CB	-	4	-	
96014	960142	830x60 mm	NS	-	4	-	
96015	960159	830x60 mm	RAL9006	-	4	-	
96101	961019	870x60 mm	BL	-	4	-	
96102	961026	870x60 mm	NE	-	4	-	
96103	961033	870x60 mm	CB	-	4	-	
96104	961040	870x60 mm	NS	-	4	-	
96105	961057	870x60 mm	RAL9006	-	4	-	
96023	960234	1200x60 mm	NS	-	4	-	

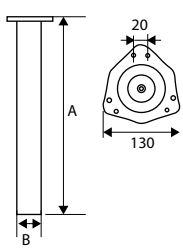

Acero

BLANCO
 NEGRO
 CROMO BRILLO
 NIQUEL SATINADO
 RAL9006



PATA MESA Ø80 MM PT6



Código	8431488	Medida	Acabado				€uros
96006	960067	710x80 mm	BL	-	4	-	
96007	960074	710x80 mm	NE	-	4	-	
96008	960081	710x80 mm	CB	-	4	-	
96009	960098	710x80 mm	NS	-	4	-	
96010	960104	710x80 mm	RAL9006	-	4	-	

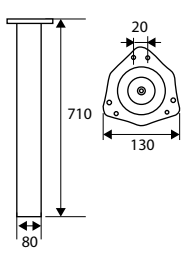

Acero

BLANCO
 NEGRO
 CROMO BRILLO
 NIQUEL SATINADO
 RAL9006



PLACA PATA PT6



Código	8431488	Rosca	Acabado				€uros
	96020	960203	M10	NE	-	1	10

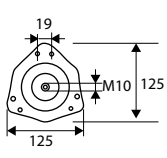

Acero

NEGRO

PATA ECO CUADRADA PT24

Código	8431488	Medida AxB	Acabado				Euros
96130	961309	100x25 mm	BL	-	4	64	
96131	961316	150x25 mm	BL	-	4	64	
96132	961323	250x25 mm	BL	-	4	100	
96133	961330	400x25 mm	BL	-	4	100	
96134	961347	700x25 mm	BL	-	4	60	
96135	961354	800x25 mm	BL	-	4	40	
96136	961361	100x25 mm	GR	-	4	64	
96137	961378	150x25 mm	GR	-	4	64	
96138	961385	250x25 mm	GR	-	4	100	
96139	961392	400x25 mm	GR	-	4	100	
96140	961408	700x25 mm	GR	-	4	60	
96141	961415	800x25 mm	GR	-	4	40	
96142	961422	100x25 mm	NE	-	4	64	
96143	961439	150x25 mm	NE	-	4	64	
96144	961446	250x25 mm	NE	-	4	100	
96145	961453	400x25 mm	NE	-	4	100	
96146	961460	700x25 mm	NE	-	4	60	
96147	961477	800x25 mm	NE	-	4	40	
96148	961484	100x25 mm	NS	-	4	64	
96149	961491	150x25 mm	NS	-	4	64	
96150	961507	250x25 mm	NS	-	4	100	
96151	961514	400x25 mm	NS	-	4	100	
96152	961521	700x25 mm	NS	-	4	60	
96153	961538	800x25 mm	NS	-	4	40	

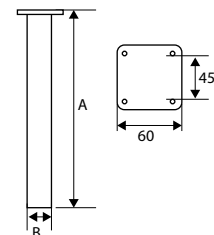
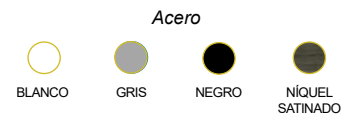

Carga máxima por pata 15 Kgs

PATA ECO REDONDA PT23

Código	8431488	Medida AxB	Acabado				Euros
96106	961064	100x30 mm	BL	-	4	64	
96107	961071	150x30 mm	BL	-	4	64	
96108	961088	250x30 mm	BL	-	4	100	
96109	961095	400x30 mm	BL	-	4	100	
96110	961101	700x30 mm	BL	-	4	60	
96111	961118	800x30 mm	BL	-	4	40	
96112	961125	100x30 mm	GR	-	4	64	
96113	961132	150x30 mm	GR	-	4	64	
96114	961149	250x30 mm	GR	-	4	100	
96115	961156	400x30 mm	GR	-	4	100	
96116	961163	700x30 mm	GR	-	4	60	
96117	961170	800x30 mm	GR	-	4	40	
96118	961187	100x30 mm	NE	-	4	64	
96119	961194	150x30 mm	NE	-	4	64	
96120	961200	250x30 mm	NE	-	4	100	
96121	961217	400x30 mm	NE	-	4	100	
96122	961224	700x30 mm	NE	-	4	60	
96123	961231	800x30 mm	NE	-	4	40	
96124	961248	100x30 mm	NS	-	4	64	
96125	961255	150x30 mm	NS	-	4	64	
96126	961262	250x30 mm	NS	-	4	100	
96127	961279	400x30 mm	NS	-	4	100	
96128	961286	700x30 mm	NS	-	4	60	
96129	961293	800x30 mm	NS	-	4	40	



No incluye nivelador

Nivelador disponible en página 369





JGO 4 PATAS SOMIER PT25



	Código	8431488	Medida AxBxC	Acabado/Tipo				€uros
Caja	96400	964003	250x30x30 mm	NE/sin rueda	-	1	10	
	96401	964010	250x30x30 mm	NE/con rueda	-	1	10	
	96402	964027	250x35x35 mm	NE/sin rueda	-	1	10	
	96403	964034	250x35x35 mm	NE/con rueda	-	1	10	
	96404	964041	250x30x40 mm	NE/sin rueda	-	1	10	
	96405	964058	250x30x40 mm	NE/con rueda	-	1	10	
	96407	964072	250x30x30 mm	GR/sin rueda	-	1	10	
	96408	964089	250x30x30 mm	GR/con rueda	-	1	10	
	96409	964096	250x35x35 mm	GR/sin rueda	-	1	10	
	96410	964102	250x35x35 mm	GR/con rueda	-	1	10	
	96411	964119	250x30x40 mm	GR/sin rueda	-	1	10	
	96412	964126	250x30x40 mm	GR/con rueda	-	1	10	
	96427	964270	300x30x30 mm	NE/sin rueda	-	1	10	
	96428	964287	300x30x30 mm	NE/con rueda	-	1	10	
	96429	964294	300x35x35 mm	NE/sin rueda	-	1	10	
	96430	964300	300x35x35 mm	NE/con rueda	-	1	10	
96431	964317	350x30x30 mm	NE/sin rueda	-	1	10		
96432	964324	350x30x30 mm	NE/con rueda	-	1	10		
96433	964331	350x35x35 mm	NE/sin rueda	-	1	10		
96434	964348	350x35x35 mm	NE/con rueda	-	1	10		

Las ref. 96404 / 96405 / 96411 / 96412 son 30x30 mm con abrazadera de 30x40 mm

Acero
 NEGRO
 GRIS

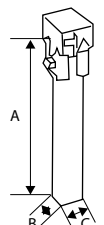

JGO 4 PATAS CANAPÉ PT26



	Código	8431488	Medida	Acabado/Tipo				€uros
Caja	96406	964065	Ø 50 mm	NE/sin rueda	-	1	9	
	96417	964171	Ø 50 mm	NE/con rueda	-	1	9	
	96413	964133	Ø 50 mm	GR/sin rueda	-	1	9	
	96418	964188	Ø 50 mm	GR/con rueda	-	1	9	

Acero
 NEGRO
 GRIS

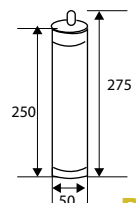

PATA CANAPÉ PT27



	Código	8431488	Medida	Acabado				€uros
	96426	964263	55x50 mm	NE	-	1	10	

Acero
 NEGRO

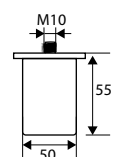

PATA MUEBLE CUADRADA PT21

	Código	8431488	Medida	Acabado			€uros
Caja	96235	962351	100 mm	BL	-	4	12
	96236	962368	100 mm	AL	-	4	12

ABS



No incluye nivelador

Nivelador disponible en página 369

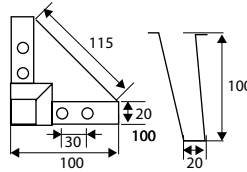

PATA MUEBLE CUADRADA PT22

	Código	8431488	Medida	Acabado			€uros
Caja	96237	963273	120 mm	BL	-	4	12
	96238	962382	120 mm	AL	-	4	12

ABS



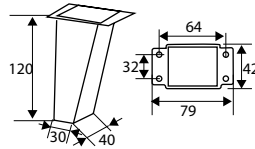

No incluye nivelador

Nivelador disponible en página 369



PATA MUEBLE CUADRADA PT1

	Código	8431488	Medida AxBxC	Acabado			€uros
Caja	96212	962122	80x80x30 mm	AL	-	4	40
	96213	962139	100x100x20 mm	AL	-	4	40

Aluminio



Presentación Bolsa 4 unidades

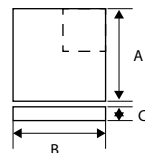



PATA MUEBLE REDONDA PT13



	Código	8431488	Medida	Acabado				€uros
Caja	96202	962023	140-160 mm	AL	-	4	24	

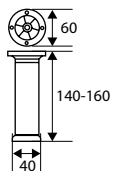

Aluminio



ALUMINIO



Presentación Bolsa 4 unidades

PATA MUEBLE REDONDA PT14



	Código	8431488	Medida A	Acabado				€uros
Blister	96203	962030	80-110 mm	AL	-	1	10	
	96204	962047	100-130 mm	AL	-	1	10	
	96205	962054	120-150 mm	AL	-	1	10	
	96206	962061	150-170 mm	AL	-	1	10	

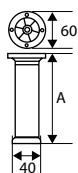

Aluminio



ALUMINIO



Presentación Gancho colgador y retráctil

PATA MUEBLE REDONDA PT18



	Código	8431488	Medida A	Acabado				€uros
Caja	96220	962207	60-80 mm	AL	-	4	24	
	96221	962214	80-100 mm	AL	-	4	24	
	96222	962221	100-120 mm	AL	-	4	24	
	96223	962238	120-140 mm	AL	-	4	24	
	96224	962245	150-170 mm	AL	-	4	24	
	96225	962252	180-200 mm	AL	-	4	24	
	96226	962269	200-220 mm	AL	-	4	24	

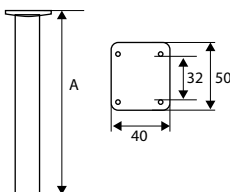

Aluminio



ALUMINIO



Presentación Bolsa 4 unidades

PATA MUEBLE CUADRADA PT16

	Código	8431488	Medida	Acabado				€uros
Caja	96200	962009	120x32x32 mm	AL	-	24	72	

Acero

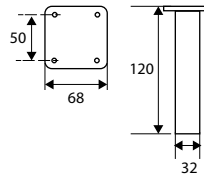

PATA MUEBLE CUADRADA PT15

	Código	8431488	Medida A	Acabado				€uros
Blister	96207	962078	60 mm	AL	1	-	10	
	96208	962085	80 mm	AL	1	-	10	
	96209	962092	100 mm	AL	1	-	10	
	96210	962108	120 mm	AL	1	-	10	
	96211	962115	150 mm	AL	1	-	10	

ABS

Incluye nivelador



Presentación
Gancho colgador y retráctil

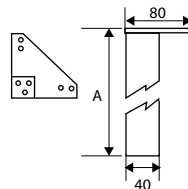

PATA MUEBLE CUADRADA PT19

	Código	8431488	Medida A	Acabado				€uros
Caja	96227	962276	60 mm	AL	-	4	24	
	96228	962283	80 mm	AL	-	4	24	
	96229	962290	100 mm	AL	-	4	24	
	96230	962306	120 mm	AL	-	4	24	
	96231	962313	150 mm	AL	-	4	24	
	96232	962320	180 mm	AL	-	4	24	
	96233	962337	200 mm	AL	-	4	24	

Aluminio

Incluye nivelador



Presentación
Bolsa 4 unidades

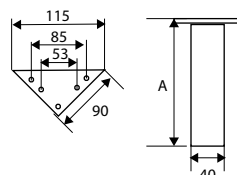



PATA MUEBLE REDONDA PT4



	Código	8431488	Medida	Acabado				€uros
Caja	96216	962160	50-70 mm	NE	-	4	16	

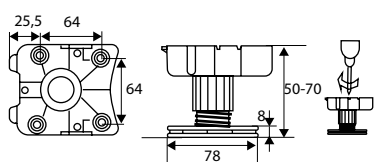

ABS
●
NEGRO

PATA MUEBLE REDONDA PT2



	Código	8431488	Medida	Acabado				€uros
Caja	96214	962146	130-190 mm	NE	-	4	12	

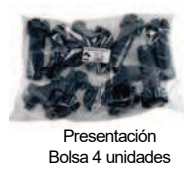
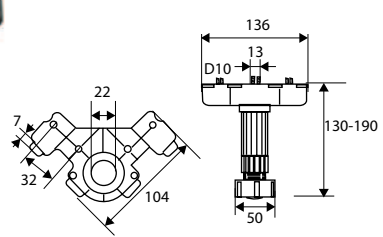

ABS
●
NEGRO

PATA MUEBLE REDONDA PT3



	Código	8431488	Medida	Acabado				€uros
Caja	96215	962153	130-200 mm	NE	-	4	20	

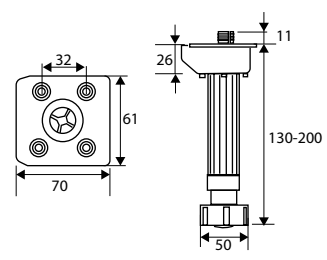

ABS
●
NEGRO

PATA MUEBLE REDONDA PT11



	Código	8431488	Medida	Acabado				€uros
Caja	96301	963013	130-200 mm	NE	-	4	48	

Espiga 13 mm.

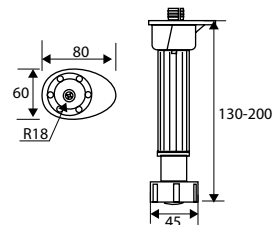

ABS
●
NEGRO

PATA MUEBLE REDONDA PT12

	Código	8431488	Medida	Tapón				€uros
Caja	96302	963020	130-200 mm	Plástico	-	4	48	
	96303	963037	130-200 mm	Zamak	-	4	48	

ABS



NEGRO



Presentación
Bolsa 4 unidades

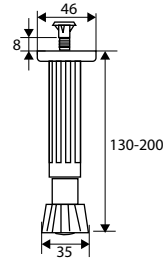

PINZA ZÓCALO ZCL5/ZCL6

	Código	8431488	Tipo	Acabado				€uros
Caja	96305	963051	madera/aluminio	NE	-	50	500	
	96306	963068	pvc/aluminio	NE	-	50	500	
Blister	90474	904740	madera/aluminio	NE	2	-	10	
	91599	915999	pvc/aluminio	NE	2	-	10	

PVC



NEGRO



96305

96306

PATA MUEBLE REDONDA PT17

	Código	8431488	Medida A	Acabado				€uros
Caja	96217	962177	35-50 mm	NE	-	40	-	
	96218	962184	45-70 mm	NE	-	30	-	
	96219	962191	65-100 mm	NE	-	20	-	

ABS



NEGRO

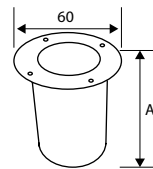

PATA MUEBLE REDONDA PT20

	Código	8431488	Medida	Acabado				€uros
Caja	96234	962344	20-30 mm	NE	-	40	400	

Polipropileno



NEGRO

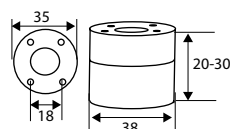



NIVELADOR REGULABLE NV12



	Código	8431488	Medida	Acabado				€uros
Caja	96701	967011	50x19 mm	NE	-	25	250	
Blister	91168	911687	50x19 mm	NE	2	-	10	

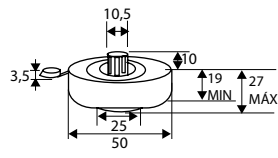

Nylon
 NEGRO

NIVELADOR REGULABLE NV13



	Código	8431488	Medida	Acabado				€uros
Caja	96702	967028	50x28 mm	NE	-	25	250	
Blister	91169	911694	50x28 mm	NE	2	-	10	

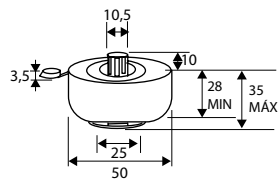

Nylon
 NEGRO

NIVELADOR TOP NV10



	Código	8431488	Medida	Acabado				€uros
Caja	96709	967097	60x30 mm	GR	-	20	200	
Blister	91320	913209	60x30 mm	GR	2	-	10	

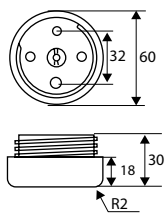

ABS
 GRIS

NIVELADOR EMBUTIR NV2



	Código	8431488	Medida	Acabado				€uros
Caja	96714	967141	30 mm	NE	-	25	250	

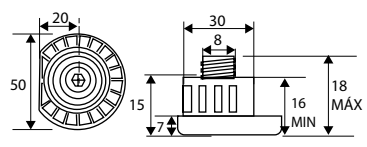

ABS
 NEGRO

NIVELADOR REGULABLE NV1

	Código	8431488	Medida	Acabado				€uros
Caja	96713	967134	0-12 mm	ZKN	-	25	125	

Zamak



ZAMAK NATURAL

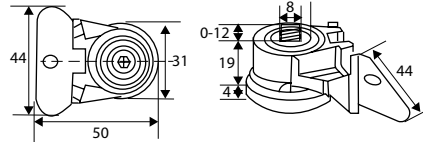

NIVELADOR REGULABLE NV3

	Código	8431488	Medida	Acabado				€uros
Caja	96715	967158	M6x17 mm	NE	-	25	625	
	96719	967196	M6x17 mm	BL	-	25	625	
Blister	91735	917351	M6x17 mm	NE	4	-	10	
	92128	921280	M6x17 mm	BL	4	-	10	

Zamak



NEGRO



BLANCO

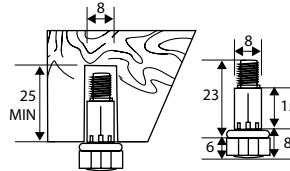

NIVELADOR PATA ECO NV9

	Código	8431488	Medida	Acabado				€uros
Caja	96155	961552	M10 x 29 mm	CB	-	25	250	
Blister	96154	961545	M10 x 29 mm	CB	4	-	10	

Acero



CROMO BRILLO

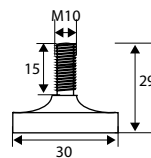

NIVELADOR PATA MUEBLE PT21/PT22

	Código	8431488	Medida	Acabado				€uros
Caja	96239	962399	M6	GR	-	25	625	
	96240	962405	M8	GR	-	25	625	

ABS



GRIS





NIVELADOR PLANO NV7

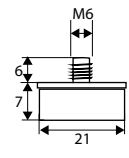

	Código	8431488	Medida	Acabado				€uros
Caja	96720	967202	M6x6 mm	NE	-	24	600	
Blister	92234	922348	M6x6 mm	NE	4	-	10	

Goma



NIVELADOR POMO NV8



	Código	8431488	Medida	Acabado				€uros
Caja	96706	967066	M6x27 mm	NE	-	25	625	
	96707	967073	M8x38 mm	NE	-	25	250	
	96708	967080	M10x40 mm	NE	-	25	250	
Blister	90549	905495	M6x27 mm	NE	4	-	10	
	90550	905501	M8x38 mm	NE	4	-	10	
	90551	905518	M10x40 mm	NE	4	-	10	

ABS

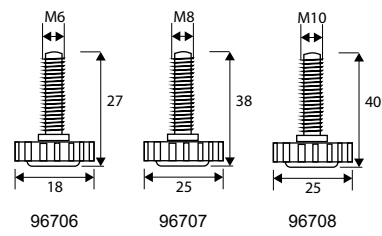

NIVELADOR PLANO NV4



	Código	8431488	Medida Ax BxC	Acabado				€uros
Caja	96717	967172	M8x32x16 mm	NE	-	10	100	
	96718	967189	M10x44x38 mm	NE	-	10	100	

ABS

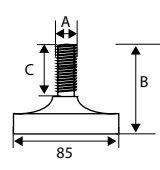

Base de 85 mm

NIVELADOR PLANO NV5

	Código	8431488	Medida AxB	Acabado				€uros
Caja	96703	967035	M6x32 mm	NE	-	25	250	
	96716	967165	M8x38 mm	NE	-	25	250	
Blister	91731	917313	M6x32 mm	NE	4	-	10	
	91732	917320	M8x38 mm	NE	4	-	10	

ABS



NEGRO



Base de 30 mm

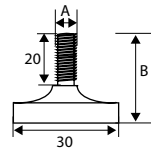

NIVELADOR PLANO NV6

	Código	8431488	Medida	Acabado				€uros
Caja	96704	967042	M8x38 mm	NE	-	25	125	
	96705	967059	M10x47 mm	NE	-	25	125	
Blister	91733	917337	M8x38 mm	NE	4	-	10	
	91734	917344	M10x47 mm	NE	4	-	10	

ABS



NEGRO



Base de 40 mm

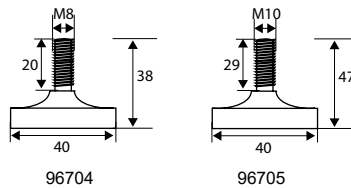

TAPA NIVELADOR PLANO NV5/NV6

	Código.	8431488	Medida	Acabado				€uros
Caja	96711	967110	30 mm	CB	-	25	250	
	96712	967127	40 mm	CB	-	25	125	
Blister	91729	917290	30 mm	CB	4	-	10	
	91730	917306	40 mm	CB	4	-	10	

ABS



CROMO BRILLO



No incluye nivelador

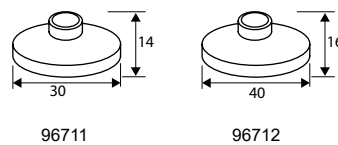

PLACA TRIÁNGULO C/ROSCA PLC13

	Código	8431488	Medida	Acabado				€uros
Caja	39503	395036	125x68 mm	ZN	-	25	125	
Blister	91738	917382	125x68 mm	ZN	4	-	10	

Acero



ZINCADO



No incluye nivelador

M10

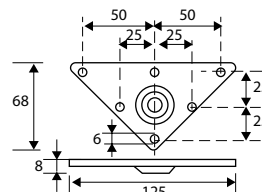



CONTERA REDONDA FLEXIBLE CNT7



A	B	C
10 mm	16 mm	3,64 mm
12 mm	17 mm	4 mm
14 mm	18 mm	4,5 mm
16 mm	19 mm	5 mm
18 mm	20 mm	5,25 mm
20 mm	22 mm	5,5 mm
22 mm	23 mm	6 mm
25 mm	24 mm	6,5 mm
28 mm	25 mm	7 mm
30 mm	26 mm	8 mm
32 mm	28 mm	9 mm
35 mm	30 mm	10 mm
40 mm	30 mm	10,25 mm
42 mm	30 mm	10,5 mm
45 mm	30 mm	11 mm
50 mm	30 mm	12 mm

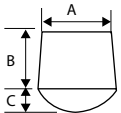

código	Ø A	Ø B	C
60892	20 mm	27 mm	30 mm
60893	25 mm	32 mm	30 mm
60893	30 mm	38 mm	35 mm

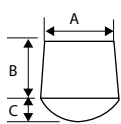

Código	8431488	Medida A	Acabado				€uros
60967	609676	10 mm	BL	-	25	625	
60968	609683	12 mm	BL	-	25	625	
60969	609690	14 mm	BL	-	25	625	
60970	609706	16 mm	BL	-	25	250	
60971	609713	18 mm	BL	-	25	250	
60972	609720	20 mm	BL	-	25	250	
60973	609737	22 mm	BL	-	25	250	
60974	609744	25 mm	BL	-	25	250	
60975	609751	28 mm	BL	-	25	250	
60976	609768	30 mm	BL	-	25	250	
60977	609775	32 mm	BL	-	25	250	
60978	609782	35 mm	BL	-	25	250	
60979	609799	40 mm	BL	-	25	250	
60980	609805	42 mm	BL	-	25	250	
60981	609812	45 mm	BL	-	20	200	
60982	609829	50 mm	BL	-	16	160	
Caja							
60983	609836	10 mm	NE	-	25	625	
60984	609843	12 mm	NE	-	25	625	
60985	609850	14 mm	NE	-	25	625	
60986	609867	16 mm	NE	-	25	250	
60987	609874	18 mm	NE	-	25	250	
60988	609881	20 mm	NE	-	25	250	
60989	609898	22 mm	NE	-	25	250	
60990	609904	25 mm	NE	-	25	250	
60991	609911	28 mm	NE	-	25	250	
60992	609928	30 mm	NE	-	25	250	
60993	609935	32 mm	NE	-	25	250	
60994	609942	35 mm	NE	-	25	250	
60995	609959	40 mm	NE	-	25	250	
60996	609966	42 mm	NE	-	25	250	
60997	609973	45 mm	NE	-	20	200	
60998	609980	50 mm	NE	-	16	160	

Caucho



CONTERA REDONDA FLEXIBLE CNT10

Código	8431488	Medida	Acabado				€uros
Caja							
60892	608921	20 mm	TR	-	25	250	
60893	608938	25 mm	TR	-	25	250	
60894	608945	30 mm	TR	-	25	250	
Blister							
92309	923093	20 mm	TR	4	-	10	
92310	923109	25 mm	TR	4	-	10	
92311	923116	30 mm	TR	4	-	10	

Flexiglass



CONTERA REDONDA FLEXIBLE CNT7

	Código	8431488	Medida A	Acabado			€uros
Blister	91907	919072	10 mm	BL	4	-	10
	91908	919089	12 mm	BL	4	-	10
	91909	919096	14 mm	BL	4	-	10
	91910	919102	16 mm	BL	4	-	10
	91911	919119	18 mm	BL	4	-	10
	91912	919126	20 mm	BL	4	-	10
	91913	919133	22 mm	BL	4	-	10
	91914	919140	25 mm	BL	4	-	10
	91915	919157	28 mm	BL	4	-	10
	91916	919164	30 mm	BL	4	-	10
	91917	919171	32 mm	BL	4	-	10
	91918	919188	35 mm	BL	4	-	10
	91919	919195	10 mm	NE	4	-	10
	91920	919201	12 mm	NE	4	-	10
	91921	919218	14 mm	NE	4	-	10
	91922	919225	16 mm	NE	4	-	10
	91923	919232	18 mm	NE	4	-	10
	91924	919249	20 mm	NE	4	-	10
	91925	919256	22 mm	NE	4	-	10
	91926	919263	25 mm	NE	4	-	10
	91927	919270	28 mm	NE	4	-	10
	91928	919287	30 mm	NE	4	-	10
	91929	919294	32 mm	NE	4	-	10
	91930	919300	35 mm	NE	4	-	10



Caucho



PATAS, NIVELADORES Y RUEDAS

CONTERA REDONDA CAUCHO CNT8

	Código	8431488	Medida A	Acabado			€uros
Caja	60896	608969	16-17 mm	NE	-	25	250
	60897	608976	18-19 mm	NE	-	25	250
	60898	608983	20-21 mm	NE	-	25	250
	60899	608990	25-26 mm	NE	-	25	250
Blister	92133	921334	16-17 mm	NE	2	-	10
	92134	921341	18-19 mm	NE	2	-	10
	92135	921358	20-21 mm	NE	2	-	10
	92136	921365	25-26 mm	NE	2	-	10



Especial para Bastones y Andadores

Caucho

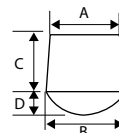

código	A	B	C	D
60896	16-17 mm	27,5 mm	26 mm	3,8 mm
60897	18-19 mm	30 mm	28 mm	3,8 mm
60898	20-21 mm	32 mm	30 mm	5,0 mm
60899	25-26 mm	37 mm	31 mm	5,0 mm



código	Ø Exterior	B	C
60945	16 mm	20 mm	4 mm
60946	18 mm	24 mm	4 mm
60901	20 mm	25 mm	4 mm
60947	22 mm	29 mm	4 mm
60902	25 mm	28 mm	3 mm
60948	28 mm	29 mm	3 mm
60949	30 mm	29 mm	5 mm
60950	32 mm	29 mm	5 mm

CONTERA REDONDA REFORZADA CNT1

	Código	8431488	Medida A	Acabado			€uros
Caja	60945	609454	16 mm	NE	-	25	250
	60946	609461	18 mm	NE	-	25	250
	60901	609010	20 mm	NE	-	25	250
	60947	609478	22 mm	NE	-	25	250
	60902	609027	25 mm	NE	-	25	250
	60948	609485	28 mm	NE	-	25	250
	60949	609492	30 mm	NE	-	25	250
	60950	609508	32 mm	NE	-	25	250
Blister	91618	916187	16 mm	NE	4	-	10
	91619	916194	18 mm	NE	4	-	10
	90857	908571	20 mm	NE	4	-	10
	91620	916200	22 mm	NE	4	-	10
	90858	908588	25 mm	NE	4	-	10
	91621	916217	28 mm	NE	4	-	10
	91622	916224	30 mm	NE	4	-	10
	91623	916231	32 mm	NE	4	-	10

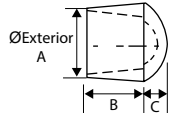

Polietileno



NEGRO



Especial para Muletas

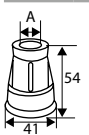

CONTERA P/MULETAS CNT9

	Código	8431488	Medida A	Acabado			€uros
Caja	60999	609997	18-19 mm	NE	-	25	250
Blister	91931	919317	18-19 mm	NE	2	-	10

Caucho



NEGRO



No incluye nivelador

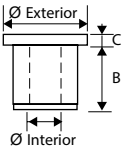

CONTERA CUADRADA C/ROSCA CNT5

	Código	8431488	Medida	Acabado			€uros
Caja	60922	609225	M10x30x30 mm	NE	-	25	250
	60923	609232	M10x40x40 mm	NE	-	25	250
Blister	91739	917399	M10x30x30 mm	NE	4	-	10
	91740	917405	M10x40x40 mm	NE	4	-	10

Polipropileno



NEGRO

código	Ø Exterior	Ø Interior	B	C
60922	30 mm	28 mm	18 mm	5 mm
60923	40 mm	38 mm	18 mm	5 mm

CONTERA REDONDA C/ROSCA CNT6

	Código	8431488	Medida	Acabado			€uros
Caja	60924	609249	M10x40 mm	NE	-	25	250
	60900	609003	M10x50 mm	NE	-	25	250
Blister	91741	917412	M10x40 mm	NE	4	-	10
	91742	917429	M10x50 mm	NE	2	-	10

Polipropileno



NEGRO



No incluye nivelador

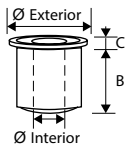

código	Ø Exterior	Ø Interior	B	C
60924	40 mm	38 mm	18 mm	6 mm
60900	50 mm	48 mm	20 mm	6 mm

CONTERA REDONDA ALETAS CNT2

	Código	8431488	Medida A	Acabado			€uros
Caja	60903	609034	20 mm	NE	-	25	250
	60904	609041	22 mm	NE	-	25	250
	60905	609058	25 mm	NE	-	25	250
	60906	609065	30 mm	NE	-	25	250
	60907	609072	35 mm	NE	-	25	250
	60908	609089	40 mm	NE	-	25	250
	60909	609096	50 mm	NE	-	25	250
	60910	609102	60 mm	NE	-	25	250
	60935	609355	70 mm	NE	-	16	160
	60936	609362	80 mm	NE	-	10	100
60937	609379	100 mm	NE	-	6	60	
Blister	90859	908595	20 mm	NE	4	-	10
	90860	908601	22 mm	NE	4	-	10
	90861	908618	25 mm	NE	4	-	10
	90862	908625	30 mm	NE	4	-	10



código	Ø Exterior	Ø Interior	B	C
60903	20 mm	16-18 mm	16 mm	5 mm
60904	22 mm	18-20 mm	16 mm	5 mm
60905	25 mm	21-23 mm	15 mm	7 mm
60906	30 mm	26-28 mm	15 mm	6 mm
60907	35 mm	31-33 mm	16 mm	7 mm
60908	40 mm	35-38 mm	17 mm	5,5 mm
60909	50 mm	45-48 mm	19 mm	6 mm
60910	60 mm	55-58 mm	20 mm	6 mm
60935	70 mm	64-68 mm	18,5 mm	6,5 mm
60936	80 mm	73-78 mm	18,5 mm	6,5 mm
60937	100 mm	96-98 mm	17 mm	5 mm

Polietileno



NEGRO

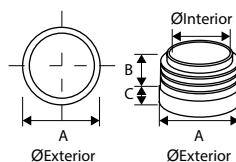

CONTERA CUADRADA ALETAS CNT3

	Código	8431488	Medida A	Acabado			€uros
Caja	60915	609157	20x20 mm	NE	-	25	250
	60938	609386	22x22 mm	NE	-	25	250
	60916	609164	25x25 mm	NE	-	25	250
	60917	609171	30x30 mm	NE	-	25	250
	60918	609188	35x35 mm	NE	-	25	250
	60919	609195	40x40 mm	NE	-	25	250
	60920	609201	50x50 mm	NE	-	25	250
	60921	609218	60x60 mm	NE	-	25	250
	60939	609393	70x70 mm	NE	-	16	160
	60940	609409	80x80 mm	NE	-	6	60
60941	609416	100x100 mm	NE	-	4	40	
Blister	90850	908502	20x20 mm	NE	4	-	10
	91615	916156	22x22 mm	NE	4	-	10
	90851	908519	25x25 mm	NE	4	-	10
	90852	908526	30x30 mm	NE	4	-	10
	90853	908533	35x35 mm	NE	4	-	10
	90854	908540	40x40 mm	NE	4	-	10



código	Ø Exterior	Ø Interior	B	C
60915	20 mm	16-18 mm	17 mm	6 mm
60938	22 mm	17-20 mm	19,5 mm	5 mm
60916	25 mm	21-23 mm	15 mm	5 mm
60917	30 mm	26-28 mm	18 mm	5,5 mm
60918	35 mm	31-33 mm	18 mm	6 mm
60919	40 mm	35-38 mm	18 mm	6 mm
60920	50 mm	45-48 mm	20 mm	6 mm
60921	60 mm	55-58 mm	20 mm	6 mm
60939	70 mm	63-67 mm	15,5 mm	7 mm
60940	80 mm	74-78 mm	21 mm	5 mm
60941	100 mm	92-98 mm	19 mm	6 mm

Polietileno



NEGRO

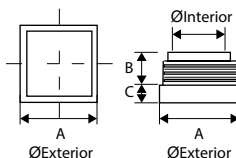



CONTERA RECTANGULAR ALETAS CNT4



código	Ø Exterior	B	C
60911	15x30 mm	16 mm	5,5 mm
60942	20x30 mm	16 mm	6 mm
60912	20x40 mm	16 mm	6 mm
60943	25x40 mm	17 mm	5 mm
60944	30x50 mm	17 mm	7 mm
60913	40x60 mm	18 mm	5,5 mm
60914	40x80 mm	20 mm	6 mm

	Código	8431488	Medida A	Acabado				€uros
Caja	60895	608952	10x40 mm	NE	-	25	250	
	60911	609119	15x30 mm	NE	-	25	250	
	60942	609423	20x30 mm	NE	-	25	250	
	60912	609126	20x40 mm	NE	-	25	250	
	60943	609430	25x40 mm	NE	-	25	250	
	60944	609447	30x50 mm	NE	-	25	250	
	60913	609133	40x60 mm	NE	-	25	250	
	60914	609140	40x80 mm	NE	-	25	250	
Blister	92227	922270	10x40 mm	NE	4	-	10	
	90855	908557	15x30 mm	NE	4	-	10	
	91616	916163	20x30 mm	NE	4	-	10	
	90856	908564	20x40 mm	NE	4	-	10	
	91617	916170	25x40 mm	NE	4	-	10	

Poliétileno



NEGRO

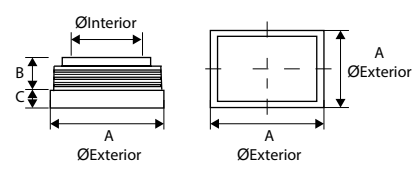

RUEDA COSTADO S/FRENO RUM2

	Código	8431488	Medida A	Acabado				€uros
Caja	60951	609515	16 mm	NE	-	4	24	
	60952	609522	19 mm	NE	-	4	24	

Peso máximo 35 Kgs

Nylon



NEGRO

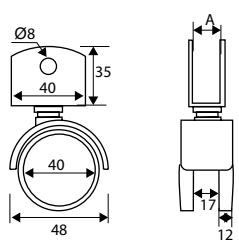

Presentación Bolsa 4 unidades



RUEDA COSTADO C/FRENO RUM2

	Código	8431488	Medida	Acabado				€uros
Caja	60953	609539	19 mm	NE	-	4	24	

Peso máximo 35 Kgs

Nylon



NEGRO

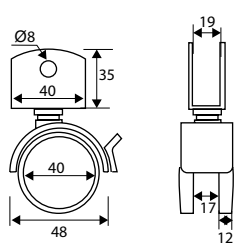

Presentación Bolsa 4 unidades

RUEDA PLACA S/FRENO RUM3

	Código	8431488	Medida A	Acabado			€uros
Caja	60954	609546	30 mm	NE	-	4	24
	60955	609553	40 mm	NE	-	4	24
	60956	609560	45 mm	NE	-	4	24
	60957	609577	50 mm	NE	-	4	24

Nylon

NEGRO



Presentación
Bolsa 4 unidades

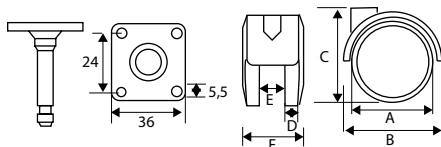

código	Peso máx.	A	B	C	D	E	F
60954	25 Kgs	30 mm	36 mm	33 mm	6 mm	12 mm	27 mm
60955	28 Kgs	40 mm	47 mm	43 mm	8 mm	13 mm	33 mm
60956	30 Kgs	45 mm	54 mm	49 mm	8 mm	16 mm	37 mm
60957	35 Kgs	50 mm	58 mm	54 mm	9 mm	20 mm	44 mm



RUEDA PLACA C/FRENO RUM3

	Código	8431488	Medida	Acabado			€uros
Caja	60958	609584	50 mm	NE	-	4	24

Nylon

Peso máximo 65 Kgs

NEGRO



Presentación
Bolsa 4 unidades

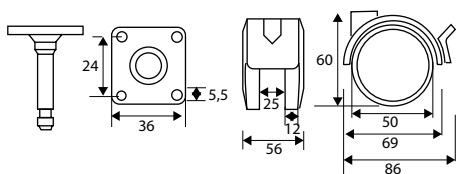

RUEDA ROSCA S/FRENO RUM4

	Código	8431488	Medida A	Acabado			€uros
Caja	60959	609591	30 mm	NE	-	4	24
	60960	609607	40 mm	NE	-	4	24
	60961	609614	50 mm	NE	-	4	24

Nylon

NEGRO



Presentación
Bolsa 4 unidades

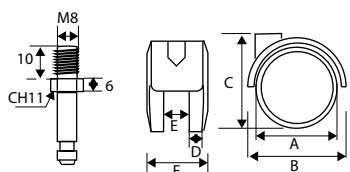

código	Peso máx.	A	B	C	D	E	F
60959	25 Kgs	30 mm	36 mm	33 mm	6 mm	12 mm	27 mm
60960	28 Kgs	40 mm	47 mm	43 mm	8 mm	13 mm	33 mm
60961	35 Kgs	45 mm	54 mm	49 mm	8 mm	16 mm	37 mm



RUEDA ROSCA C/FRENO RUM4

	Código	8431488	Medida	Acabado			€uros
Caja	60962	609621	50 mm	NE	-	4	24

Nylon

Peso máximo 65 Kgs

NEGRO



Presentación
Bolsa 4 unidades

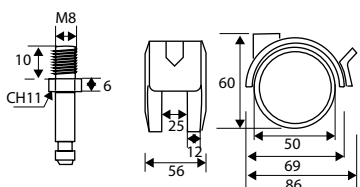



RUEDA PLACA S/FRENO RUM5

	Código	8431488	Medida	Acabado				€uros
Caja	60963	609638	50 mm	NE/GR	-	4	24	

Peso máximo 65 Kgs

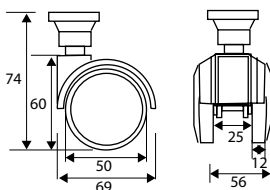

Con goma, recomendado para parquet

PVC

NEGRO/GRIS



Presentación Bolsa 4 unidades

RUEDA PLACA C/FRENO RUM5

	Código	8431488	Medida	Acabado				€uros
Caja	60964	609645	50 mm	NE/GR	-	4	24	

Peso máximo 65 Kgs

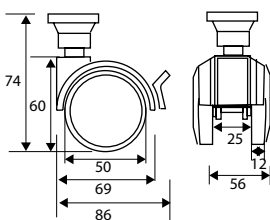

Con goma, recomendado para parquet

PVC

NEGRO/GRIS



Presentación Bolsa 4 unidades

RUEDA ROSCA S/FRENO RUM6

	Código	8431488	Medida	Acabado				€uros
Caja	60965	609652	50 mm	NE/GR	-	4	24	

Peso máximo 65 Kgs

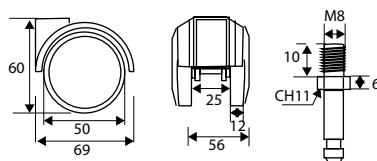

Con goma, recomendado para parquet

PVC

NEGRO/GRIS



Presentación Bolsa 4 unidades

RUEDA ROSCA C/FRENO RUM6

	Código	8431488	Medida	Acabado				€uros
Caja	60966	609669	50 mm	NE/GR	-	4	24	

Peso máximo 65 Kgs

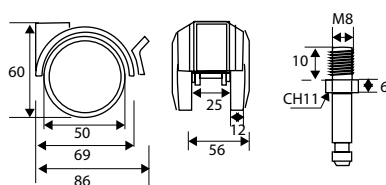

Con goma, recomendado para parquet

PVC

NEGRO/GRIS



Presentación Bolsa 4 unidades

RUEDA EMBUTIR GIRATORIA RUM7

	Código	8431488	Medida	Acabado				€uros
Caja	60925	609256	ø54 mm	NE	-	25	250	
Blister	91146	911465	ø54 mm	NE	1	-	10	

Nylon

Carga máxima por rueda 50 Kgs



NEGRO

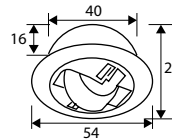

RUEDA EMBUTIR FIJA RUM8

	Código	8431488	Medida	Acabado				€uros
Caja	60926	609263	ø54 mm	NE	-	25	250	
Blister	91147	911472	ø54 mm	NE	1	-	10	

Nylon

Carga máxima por rueda 50 Kgs



NEGRO

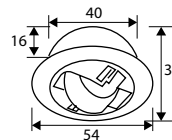

RUEDA EMBUTIR RUM1

	Código	8431488	Medida	Acabado				€uros
Caja	60934	609348	ø22 mm	NE	-	25	250	
Blister	92203	922034	ø22 mm	NE	2	-	10	

Nylon

Carga máxima por rueda 50 Kgs



NEGRO

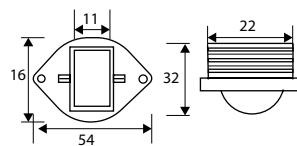

RUEDA MUEBLE FIJA RUM9

	Código	8431488	Medida	Acabado				€uros
Caja	60927	609270	15 mm	ZN	-	50	500	
	60928	609287	25 mm	ZN	-	50	500	
	60929	609294	30 mm	ZN	-	25	250	
Blister	91148	911489	15 mm	ZN	4	-	10	
	91149	911496	25 mm	ZN	4	-	10	
	91150	911502	30 mm	ZN	4	-	10	

Acero



ZINCADO

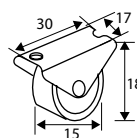

60927
Carga máxima
15 Kgs

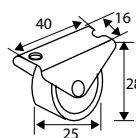

60928
Carga máxima
20 Kgs

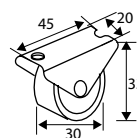

60929
Carga máxima
25 Kgs





RUEDA NIDO EMBUTIR RUM11



	Código	8431488	Medida	Acabado				€uros
Caja	60931	609317	50 mm	GR	-	10	100	
Blister	91490	914909	50 mm	GR	1	-	10	

Carga máxima 60 Kgs
Rueda de goma

Acero



GRIS

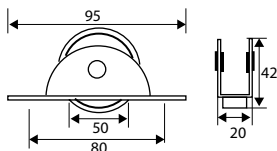

RUEDA NIDO CIRCULAR RUM12



	Código	8431488	Medida	Acabado				€uros
Caja	60932	609324	50 mm	GR	-	10	100	
Blister	91491	914916	50 mm	GR	1	-	10	

Carga máxima 60 Kgs
Rueda de goma

Acero



GRIS

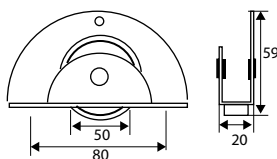

RUEDA NIDO RECTANGULAR RUM13



	Código	8431488	Medida	Acabado				€uros
Caja	60933	609331	50 mm	GR	-	10	100	

Carga máxima 60 Kgs
Rueda de goma

Acero



GRIS

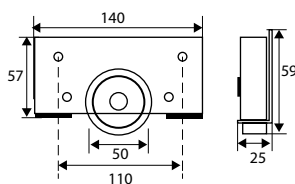

RUEDA NIDO LATERAL RUM10



	Código	8431488	Medida	Acabado				€uros
Caja	60930	609300	35 mm	ZN	-	25	250	
Blister	91489	914893	35 mm	ZN	1	-	10	

Carga máxima 40 Kgs

Acero



ZINCADO

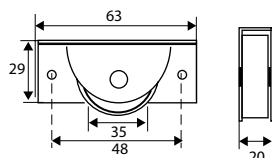



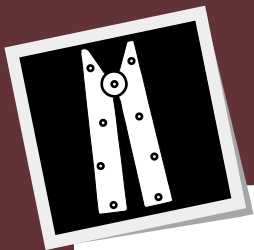

JGO BISAGRA CANAPÉ BCP4

Código	8431488	Medida	Acabado				€uros
93011	930114	710x115 mm	NE	-	1	5	

No incluye pistón

Acero

●
NEGRO

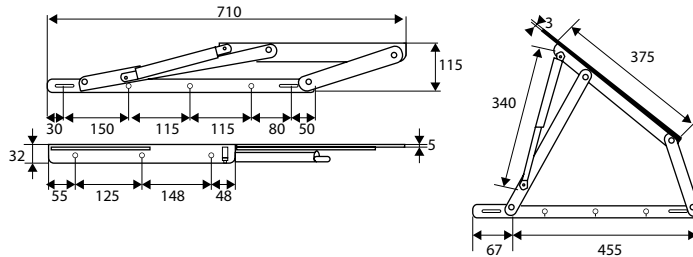

Cálculo de Newtons

Hay que tener en cuenta el peso de la cama a la hora de elegir el amortiguador adecuado. Éste se calcula sumando el peso del somier, el colchón y la ropa de cama. Además hay que tener en cuenta la construcción.

Como regla podemos decir que:

1. - Abatible por el lado corto 1 Kilogramo corresponde con 18 N
2. - Abatible por el lado largo 1 Kilogramo corresponde con 10 N
3. - Abatible doble por el lado corto 1 Kilogramo corresponde con 14 N

Para una conversión mas precisa se debe usar la siguiente fórmula:

$$N = \frac{Kg \times m}{s^2}$$

Newton, es la cantidad de fuerza que se debe aplicar para proporcionarle una aceleración de 1 m/s², a un objeto de 1 Kg de masa.



PISTÓN GAS CANAPÉ BCP4

Código	8431488	Potencia	Acabado				€uros
93024	930244	350 Nw	NE	-	1	50	
93012	930121	800 Nw	NE	-	1	50	
93013	930138	1150 Nw	NE	-	1	50	
93014	930145	1250 Nw	NE	-	1	50	
93015	930152	1400 Nw	NE	-	1	50	

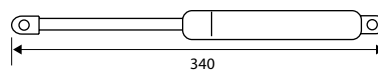

Acero

●
NEGRO

PISTÓN GAS ELEVABLE BCP1

	Código	8431488	Potencia	Medida			€uros
Caja	93003	930039	8 kgs/78 Nw	255 mm	-	10	100
	93004	930046	12 kgs/117 Nw	255 mm	-	10	100
	93023	930237	15 kgs/148 Nw	255 mm	-	10	100
	93022	930220	18 kgs/177 Nw	255 mm	-	10	100
Blister	90636	906362	8 kgs/78 Nw	255 mm	1	-	10
	90637	906379	12 kgs/117 Nw	255 mm	1	-	10

Aluminio

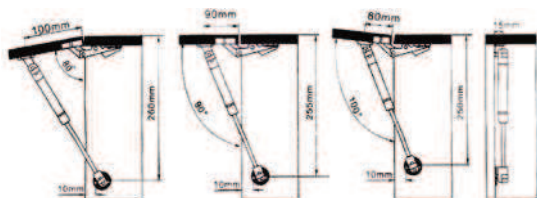
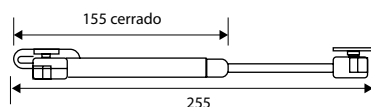

PISTÓN GAS ELEVABLE FRICCIONADO BCP2

	Código	8431488	Potencia	Medida			€uros
Caja	93010	930107	12 kgs/117 Nw	255 mm	-	10	100

Aluminio



Sistema de fricción, mantiene la puerta en la diferentes posiciones

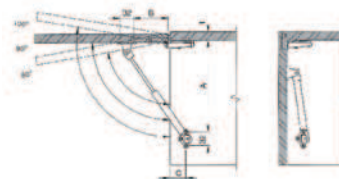
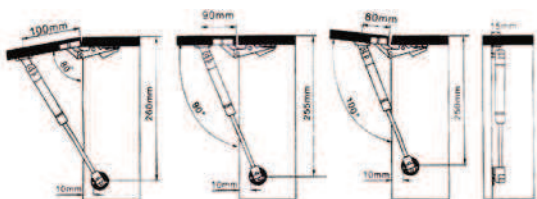
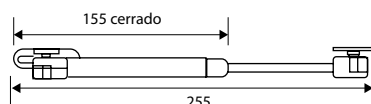

PISTÓN GAS ABATIBLE BCP3

	Código	8431488	Potencia	Medida			€uros
Caja	93009	930091	6 kgs/59 Nw	255 mm	-	10	100

Aluminio

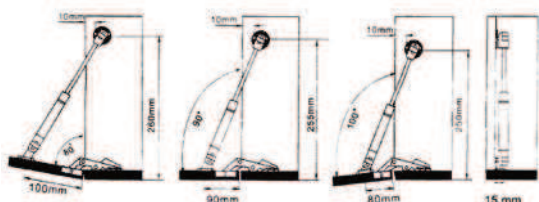
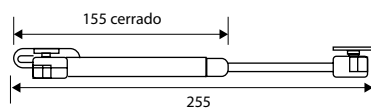

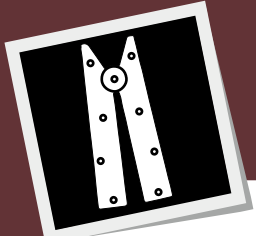

COMPASES

COMPÁS ELEVABLE BCP8

	Código	8431488	Potencia/Mano	Acabado				€uros
Caja	93018	930183	2,5-4 kgs/derecha	GR	-	1	20	
	93019	930190	2,5-4 kgs/izquierda	GR	-	1	20	
	93020	930206	4,5 - 6,5 kgs/derecha	GR	-	1	20	
	93021	930213	4,5 - 6,5 kgs/izquierda	GR	-	1	20	



Tornillo de ajuste
Posición aleatoria
Ajuste de velocidad
Regulación de peso

Acero
 GRIS

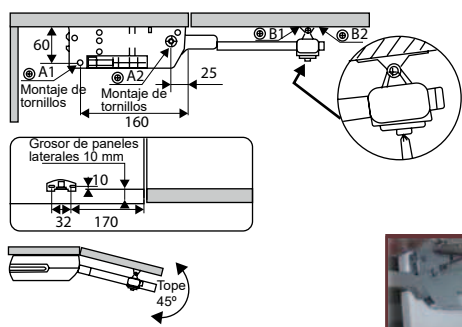

COMPÁS ELEVABLE REGULABLE BCP6

	Código	8431488	Medida	Acabado				€uros
Caja	93005	930053	100 mm	NI	-	10	100	
Blister	91151	911519	100 mm	NI	1	-	10	



Sistema de fricción, mantiene la puerta en la posición deseada

Zamak
 NIQUEL

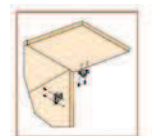
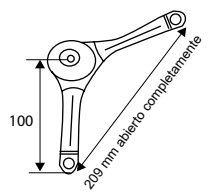
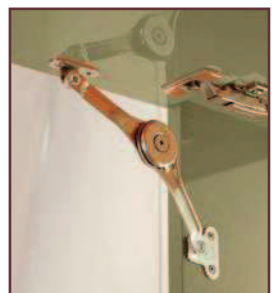

Atomilla al mueble los enganches de succión rápida.

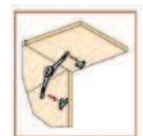

Insertar a presión al compás BCP6 en los enganches de succión rápida, quedando el tornillo de regulación al interior del mueble (nunca al exterior).

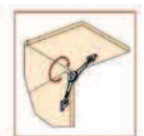

Regule la fuerza según el peso y las dimensiones de las puertas.

COMPÁS PUERTA ELEVABLE BCP7

	Código	8431488	Mano	Acabado				€uros
	93016	930169	derecha	NI	-	1	10	
	93017	930176	izquierda	NI	-	1	10	

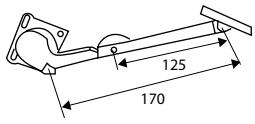

Acero
 NIQUEL

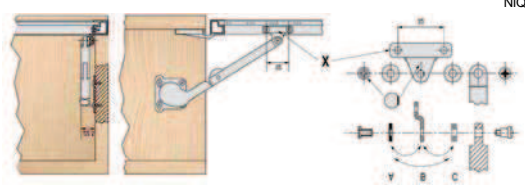

BISAGRA COMPÁS BCP5

	Código	8431488	Medida A	Acabado				€uros
Caja	93006	930060	200 mm	ZN	-	30	150	
	93007	930077	250 mm	ZN	-	30	150	
Blister	90601	906010	200 mm	ZN	1	-	10	

Acero



ZINCADO

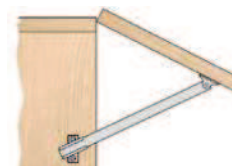
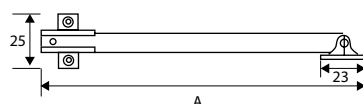

BISAGRA COMPÁS BCP12

	Código	8431488	Medida A	Acabado				€uros
Caja	92997	929972	150 mm	ZN	-	10	100	
	92998	929989	200 mm	ZN	-	10	100	
	92999	929996	250 mm	ZN	-	10	100	
	93000	930008	300 mm	ZN	-	10	100	
Blister	92334	923345	150 mm	ZN	1	-	10	
	92335	923352	200 mm	ZN	1	-	10	

Acero



ZINCADO

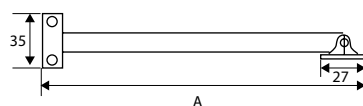

BISAGRA COMPÁS BCP9

	Código	8431488	Medida/Mano	Acabado				€uros
Caja	34201	342016	200 mm/izda	LTD	-	6	60	
	34202	342023	200 mm/dcha	LTD	-	6	60	
	34251	342511	250 mm/izda	LTD	-	6	60	
	34252	342528	250 mm/dcha	LTD	-	6	60	
	34203	342030	200 mm/izda	NI	-	6	60	
	34204	342047	200 mm/dcha	NI	-	6	60	
	34205	342054	250 mm/izda	NI	-	6	60	
	34206	342061	250 mm/dcha	NI	-	6	60	
Blister	92301	923017	200 mm/izda	LTD	1	-	10	
	92302	923024	200 mm/dcha	LTD	1	-	10	
	92303	923031	250 mm/izda	LTD	1	-	10	
	92304	923048	250 mm/dcha	LTD	1	-	10	
	92305	923055	200 mm/izda	NI	1	-	10	
	92306	923062	200 mm/dcha	NI	1	-	10	
	92307	923079	250 mm/izda	NI	1	-	10	
	92308	923086	250 mm/dcha	NI	1	-	10	

Acero



LATONADO

NÍQUEL

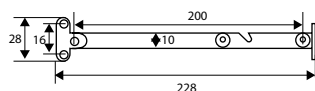

34201-34202-34203-34204

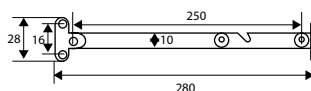

34251-34252-34205-34206



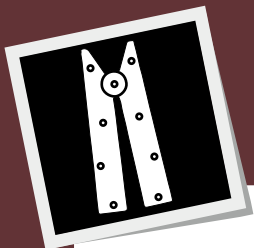

COMPÁS CABALLETE BCP10

	Código	8431488	Medida	Acabado				€uros
Caja	34200	342009	119x15 mm	ZN	-	25	250	
Blister	91685	916859	119x15 mm	ZN	2	-	10	

Espesor 1 mm

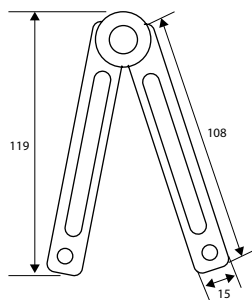

Acero



ZINCADO

COMPÁS ESCALERA BCP11

	Código	8431488	Medida	Acabado				€uros
Caja	67333	673332	190x30 mm	ZN	-	10	50	
Blister	92204	922041	190x30 mm	ZN	2	-	10	

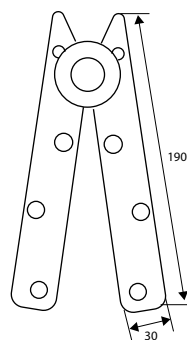

Acero



ZINCADO





RECOGEDOR EMBUTIR PR1



	Código	8431488	Medida	Acabado				€uros
	90007	900070	14 mm	BL	-	1	5	
	90008	900087	14 mm	GR	-	1	5	
	90009	900094	14 mm	MA	-	1	5	
	90010	900100	18 mm	BL	-	1	5	
	90011	900117	18 mm	GR	-	1	5	
	90012	900124	18 mm	MA	-	1	5	
<i>Blister</i>	91743	917436	14 mm	BL	1	-	3	
	91744	917443	14 mm	GR	1	-	3	
	91745	917450	14 mm	MA	1	-	3	
	91746	917467	18 mm	BL	1	-	3	
	91747	917474	18 mm	GR	1	-	3	
	91748	917481	18 mm	MA	1	-	3	

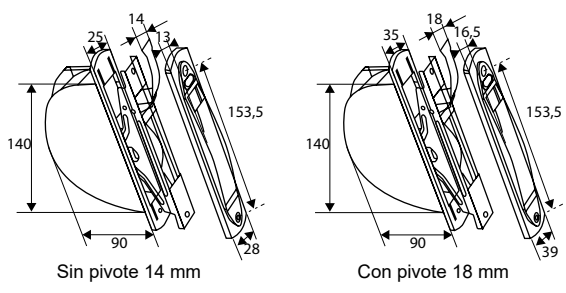

ABS
 BLANCO
 GRIS
 MARRÓN

RECOGEDOR ABATIBLE PR2



	Código	8431488	Medida	Acabado				€uros
	90013	900131	14 mm	BL	-	1	5	
	90014	900148	14 mm	GR	-	1	5	
	90015	900155	14 mm	MA	-	1	5	
	90016	900162	14 mm	MF	-	1	5	
	90017	900179	18 mm	BL	-	1	5	
	90018	900186	18 mm	GR	-	1	5	
	90019	900193	18 mm	MA	-	1	5	
	90020	900209	18 mm	MF	-	1	5	
<i>Blister</i>	91749	917498	14 mm	BL	1	-	3	
	91750	917504	14 mm	GR	1	-	3	
	91751	917511	14 mm	MA	1	-	3	
	91752	917528	14 mm	MF	1	-	3	
	91753	917535	18 mm	BL	1	-	3	
	91754	917542	18 mm	GR	1	-	3	
	91755	917559	18 mm	MA	1	-	3	
	91756	917566	18 mm	MF	1	-	3	

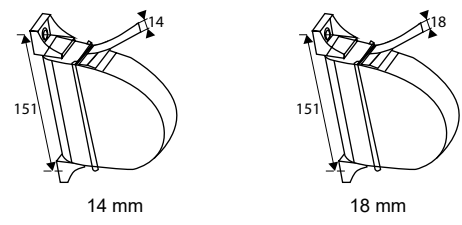

ABS
 BLANCO
 GRIS
 MARRÓN
 MARFIL

CAJETÍN OBRA PLÁSTICO PR3

Código	8431488	Modelo	Acabado				€uros
90028	900285	pequeño	NE	-	1	5	
90029	900292	grande	NE	-	1	5	

Polietileno



NEGRO

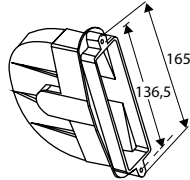

Pequeño

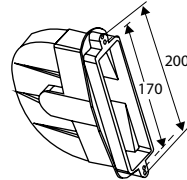

Grande



RECOGEDOR PLÁSTICO PR4

Código	8431488	Modelo	Acabado				€uros
90021	900216	pequeño	BL	-	1	5	
90022	900223	grande	BL	-	1	5	
<i>Blister</i> 91757	917573	pequeño	BL	1	-	3	
91758	917580	grande	BL	1	-	3	

Polietileno



BLANCO

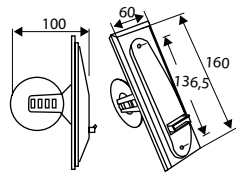

Pequeño

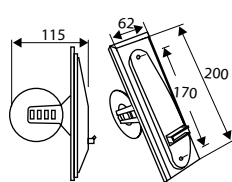

Grande



RECOGEDOR METÁLICO PR5

Código	8431488	Medida	Acabado				€uros
90023	900230	188x47 mm	ZN	-	1	5	
<i>Blister</i> 91759	917597	188x47 mm	ZN	1	-	3	

Acero



ZINCADO

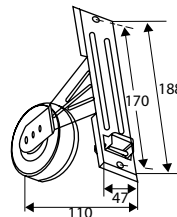

EMBELLECEDOR P/RECOGEDOR PR6

Código	8431488	Medida	Acabado				€uros
90024	900247	223x65 mm	AL	-	1	5	
90025	900254	223x65 mm	BL	-	1	5	
90026	900261	223x65 mm	OR	-	1	5	
90027	900278	223x65 mm	BR	-	1	5	
<i>Blister</i> 91760	917603	223x65 mm	AL	1	-	10	
91761	917610	223x65 mm	BL	1	-	10	
91762	917627	223x65 mm	OR	1	-	10	
91763	917634	223x65 mm	BR	1	-	10	

Aluminio



ALUMINIO BLANCO ORO BRONCE

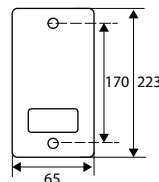



GUÍA CINTA PERSIANA PLÁSTICO PR10



	Código	843 1488	Medida	Acabado				€uros
Caja	90030	900308	62x40 mm	BL	-	10	100	
Blister	91766	917665	62x40 mm	BL	1	-	10	

Polipropileno

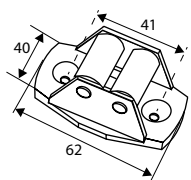

BLANCO

GUÍA CINTA PERSIANA METÁLICA PR11



	Código	843 1488	Medida	Acabado				€uros
Caja	90031	900315	65x27 mm	BL	-	10	100	
	90032	900322	65x27 mm	AL	-	10	100	
Blister	91767	917672	65x27 mm	BL	1	-	10	
	91768	917689	65x27 mm	AL	1	-	10	

Acero

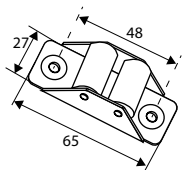

BLANCO ALUMINIO

CARCASA GUÍA CINTA PR12



	Código	843 1488	Medida	Acabado				€uros
Caja	90033	900339	72x40 mm	BL	-	10	100	
	90034	900346	72x40mm	AL	-	10	100	
Blister	91769	917696	72x40 mm	BL	1	-	10	
	91770	917702	72x40 mm	AL	1	-	10	

Acero

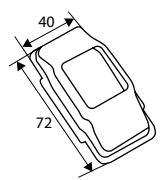

BLANCO ALUMINIO

SOPORTE RODILLOS PR13

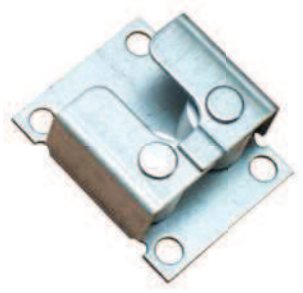

	Código	843 1488	Medida	Acabado				€uros
Caja	90038	900384	50x40 mm	ZN	-	10	100	
Blister	91772	917726	50x40 mm	ZN	1	-	10	

Acero

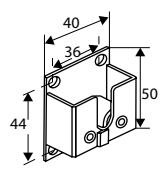

ZINCADO

SOPORTE PINCHO PR14

	Código	8431488	Medida	Acabado				€uros
Caja	90037	900377	46x26 mm	ZN	-	10	100	
Blister	91771	917719	46x26 mm	ZN	1	-	10	

Acero

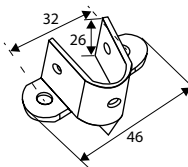

SOPORTE P/RODAMIENTO PR15

	Código	8431488	Medida	Acabado				€uros
Caja	90035	900353	68x40 mm	ZN	-	10	100	

Acero

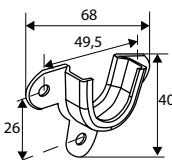

RODAMIENTO PERSIANA PR16

	Código	8431488	Medida	Acabado				€uros
Caja	90036	900360	28 mm	ZN	-	10	250	

Acero

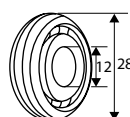

SOPORTE PR15 + RODAMIENTO PR16

	Código	8431488	Medida	Acabado				€uros
Blister	91773	917733	28 mm	ZN	1+1	-	10	

Acero





TORNO PERSIANA EMPOTRAR PR17

	Código	8431488	Medida	Acabado				€uros
Caja	90039	900391	112x73 mm	BL	-	1	10	

Carga máxima 20 Kgs

ABS

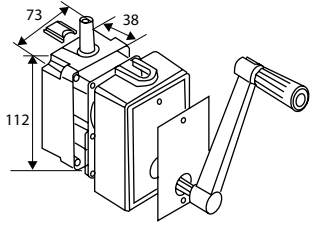

MECANISMO TORNO PERSIANA EMPOTRAR PR17

	Código	8431488	Medida	Acabado				€uros
Caja	90073	900735	112x73 mm	NE	-	1	10	

Carga máxima 20 Kgs

ABS

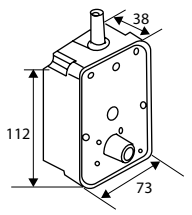

EMBELLECEDOR P/TORNO PR17

	Código	8431488	Medida	Acabado				€uros
	90072	900728	122x85 mm	AL	-	1	10	

Aluminio

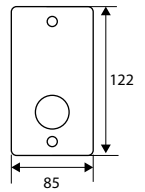

MANILLA P/TORNO PERSIANA PR17

	Código	8431488	Medida	Acabado				€uros
	90040	900407	140 mm	BL	-	1	10	

ABS

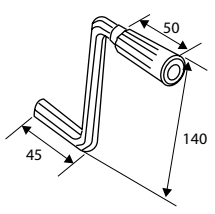

CUERDA P/TORNO PERSIANA PR17

	Código	8431488	Medida	Acabado				€uros
Caja	90089	900896	6 mts	BL	-	10	100	
Blister	92173	921730	6 mts	BL	1	-	10	

Poliamida



BLANCO

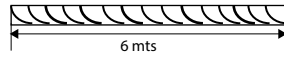

TIRANTE C/FLEJE PR18

	Código	8431488	Medida	Acabado				€uros
Caja	90074	900742	150x105 mm	GR	-	10	200	
Blister	92151	921518	150x105 mm	GR	2	-	10	

Poliamida/Acero Inoxidable



GRIS

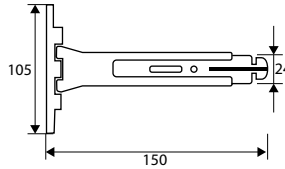

SEGURO PERSIANA PASADOR PR22

	Código	8431488	Medida Ax B	Acabado				€uros
Caja	90079	900797	6x80 mm	BC	-	10	250	
	90080	900803	6x150 mm	BC	-	10	250	
Blister	92152	921525	6x80 mm	BC	2	-	10	

Acero



BICROMATADO



SEGURO PERSIANA PR9

	Código	8431488	Medida	Acabado				€uros
Caja	90004	900049	120x25x8 mm	BL	-	6	60	
	90005	900056	120x25x8 mm	NE	-	6	60	
	90006	900063	120x25x8 mm	CB	-	6	60	
Blister	91575	915753	120x25x8 mm	BL	2	-	10	
	91576	915760	120x25x8 mm	NE	2	-	10	
	91577	915777	120x25x8 mm	CB	2	-	10	

Acero



BLANCO

NEGRO

CROMO BRILLO

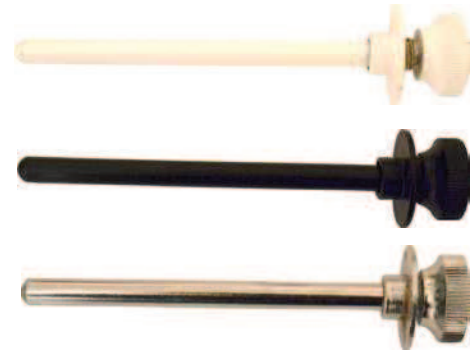
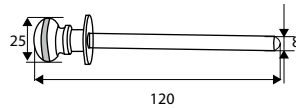

SEGURO PERSIANA CUÑA DENTADA PR25

	Código	8431488	Medida	Acabado				€uros
Caja	90093	900933	135x37 mm	INOX	-	6	60	
Blister	92370	923703	135x37 mm	INOX	2	-	10	

Acero Inoxidable



INOX

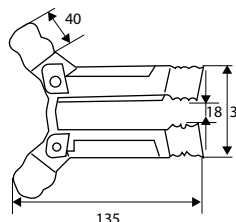



TOPE PERSIANA PR8



	Código	8431488	Medida	Acabado				€uros
Caja	90041	900414	40 mm	BL	-	25	250	
	90042	900421	40 mm	GR	-	25	250	
	90043	900438	40 mm	MA	-	25	250	
	90044	900445	40 mm	MF	-	25	250	
	90045	900452	60 mm	BL	-	25	250	
	90046	900469	60 mm	GR	-	25	250	
	90047	900476	60 mm	MA	-	25	250	
	90048	900483	60 mm	MF	-	25	250	
Blister	91774	917740	40 mm	BL	2	-	10	
	91775	917757	40 mm	GR	2	-	10	
	91776	917764	40 mm	MA	2	-	10	
	91777	917771	40 mm	MF	2	-	10	
	91778	917788	60 mm	BL	2	-	10	
	91779	917795	60 mm	GR	2	-	10	
	91780	917801	60 mm	MA	2	-	10	
	91781	917818	60 mm	MF	2	-	10	

Tornillo metálico

Poliestireno

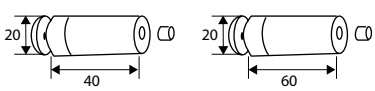

POLEA PLÁSTICO P/RODAMIENTO PR21

	Código	8431488	Cinta	Acabado				€uros
	90077	900773	18 mm	NE	-	1	5	

Válido para medidas de cinta inferiores

Nylon

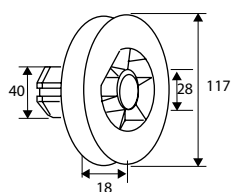

POLEA PLÁSTICO ESPIGA PR21

	Código	8431488	Cinta	Acabado				€uros
	90078	900780	18 mm	NE	-	1	5	

Válido para medidas de cinta inferiores

Nylon

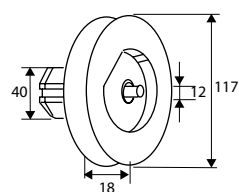

POLEA METÁLICA PR19

Código	8431488	Cinta	Acabado				€uros
	90075	900759	22 mm	ZN	-	1	5

Acero



Válido para medidas de cinta inferiores

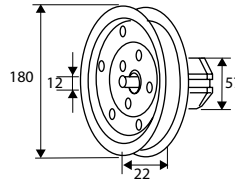

CONTERA METÁLICA PR20

Código	8431488	Medida A	Acabado				€uros
	90090	900902	42 mm	ZN	-	1	5
	90076	900766	57 mm	ZN	-	1	5

Acero

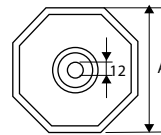

TUBO EJE OCTOGONAL PR23

Código	8431488	Medida A	Acabado				€uros
	90091	900919	42x2 mts	GV	-	1	6
	90092	900926	57x2 mts	GV	-	1	6

Acero



Espesor 0,4 mm

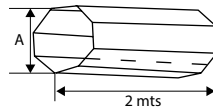

LAMA PERSIANA PR24

Código	8431488	Medida	Acabado				€uros
	90081	900810	39 mm x 2 mts	BL	-	20	-
	90083	900834	39 mm x 2 mts	MF	-	20	-
	90082	900827	52 mm x 2 mts	BL	-	20	-
	90084	900841	52 mm x 2 mts	MF	-	20	-

PVC



90081
90083



90082
90084

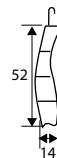

LAMA PERSIANA FINAL PR24

Código	8431488	Mod. Lama/Medida	Acabado				€uros
	90085	900858	39/50 mm x 2 mts	BL	-	10	-
	90087	900872	39/50 mm x 2 mts	MF	-	10	-
	90086	900865	52/50 mm x 2 mts	BL	-	10	-
	90088	900889	52/50 mm x 2 mts	MF	-	10	-

PVC



90085
90087



90086
90088

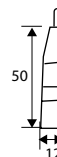

Válido para lama de 39 mm

Válido para lama de 52 mm





CINTA PERSIANA PR26

	Código	8431488	Medida	Acabado				€uros
	90049	900490	14x6 mts	BL	-	1	10	
	90050	900506	14x6 mts	GR	-	1	10	
	90051	900513	14x6 mts	MA	-	1	10	
	90052	900520	14x6 mts	BE	-	1	10	
	90053	900537	14x6 mts	BL/PI	-	1	10	
	90063	900636	14x50 mts	BL	-	1	10	
	90064	900643	14x50 mts	GR	-	1	10	
	90065	900650	14x50 mts	BE	-	1	10	
Blister	91782	917825	14x6 mts	BL	1	-	10	
	91783	917832	14x6 mts	GR	1	-	10	
	91784	917849	14x6 mts	MA	1	-	10	
	91785	917856	14x6 mts	BE	1	-	10	
	91786	917863	14x6 mts	BL/PI	1	-	10	

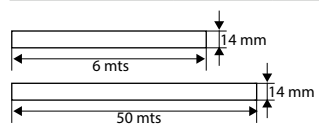

Polipropileno

BLANCO
 GRIS
 MARRÓN
 BEIGE
 BLANCO/PINTAS

CINTA PERSIANA PR26

	Código	8431488	Medida	Acabado				€uros
	90056	900568	18x6 mts	BL	-	1	10	
	90057	900575	18x6 mts	BL/PI	-	1	10	
	90058	900582	18x6 mts	GR	-	1	10	
	90059	900599	18x6 mts	BE	-	1	10	
	90066	900667	18x50 mts	BL	-	1	10	
	90067	900674	18x50 mts	GR	-	1	10	
	90068	900681	18x50 mts	BE	-	1	10	
	Blister	91789	917894	18x6 mts	BL	1	-	10
91790		917900	18x6 mts	BL/PI	1	-	10	
91791		917917	18x6 mts	GR	1	-	10	
91792		917924	18x6 mts	BE	1	-	10	

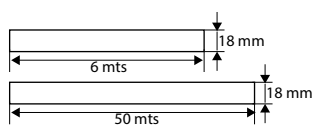

Polipropileno

BLANCO
 BLANCO/PINTAS
 GRIS
 BEIGE

CINTA PERSIANA PR26

	Código	8431488	Medida	Acabado				€uros	
	90060	900605	22x6 mts	BL	-	1	10		
	90061	900612	22x6 mts	GR/BL	-	1	10		
	90062	900629	22x6 mts	BE/BL	-	1	10		
	90069	900698	22x50 mts	BL	-	1	10		
	90070	900704	22x50 mts	GR/BL	-	1	10		
	90071	900711	22x50 mts	BE/BL	-	1	10		
	Blister	91793	917931	22x6 mts	BL	1	-	10	
		91794	917948	22x6 mts	GR/BL	1	-	10	
91795		917955	22x6 mts	BE/BL	1	-	10		

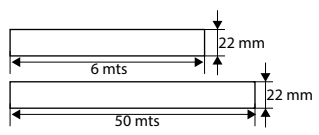

Polipropileno

BLANCO
 BEIGE/BLANCO
 GRIS/BLANCO





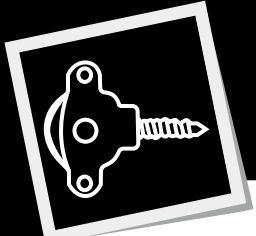

PERFIL PROTECTOR CANTOS C/ESQUINERAS SI2



	Código	8431488	Medida	Acabado				€uros
Blister	00458	004587	2 mts	BL	1	-	6	
	00459	004594	2 mts	MA	1	-	6	

Fácil de instalar gracias a su sistema adhesivo con cinta 3M
Fabricado en material acolchado, muy suave y blando
Reduce los daños ante caídas o golpes contra cantos o esquinas

Goma NBR



PERFIL PROTECTOR CANTOS SI1



	Código	8431488	Medida	Acabado				€uros
Blister	00456	004563	2 mts	BL	1	-	6	
	00457	004570	2 mts	MA	1	-	6	

Fácil de instalar gracias a su sistema adhesivo con cinta 3M
Fabricado en material acolchado, muy suave y blando
Reduce los daños ante caídas o golpes contra cantos o esquinas

Goma NBR



PROTECTOR ESQUINA SI3



	Código	8431488	Medida	Acabado				€uros
Blister	00460	004600	60x60 mm	BL	4	-	6	
	00461	004617	60x60 mm	MA	4	-	6	

Fácil de instalar gracias a su sistema adhesivo con cinta 3M
Fabricado en material acolchado, muy suave y blando
Reduce los daños ante caídas o golpes contra cantos o esquinas

Goma NBR



Seguridad infantil

PROTECTOR ESQUINA SI4

	Código	8431488	Medida	Acabado				€uros
Blister	00462	004624	42 mm	TR	4	-	6	

PVC

TRANSPARENTE

Fácil de instalar gracias a su sistema adhesivo con cinta 3M
Fabricado en material flexible y transparente, no altera el aspecto del mueble
Reduce los daños ante caídas o golpes contra cantos o esquinas

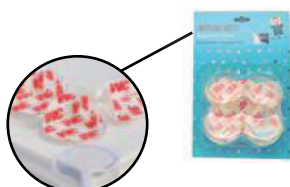

PROTECTOR ESQUINA SI5

	Código	8431488	Medida	Acabado				€uros
Blister	00463	004631	40x40 mm	TR	4	-	6	

PVC

TRANSPARENTE

Fácil de instalar gracias a su sistema adhesivo con cinta 3M
Fabricado en material flexible y transparente, no altera el aspecto del mueble
Reduce los daños ante caídas o golpes contra cantos o esquinas

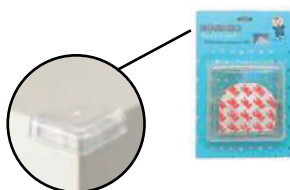

CIERRE SEGURIDAD SI6

	Código	8431488	Medida	Acabado				€uros
Blister	00464	004648	145 mm	BL	1	-	6	
	00465	004655	165 mm	BL	1	-	6	

PVC

BLANCO

Fácil de instalar gracias a su sistema adhesivo con cinta 3M
Cierre de manera segura sus armarios, cajones, etc.

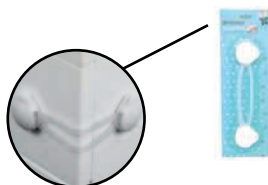

CIERRE SEGURIDAD REGULABLE SI7

	Código	8431488	Medida	Acabado				€uros
Blister	00466	004662	45x35 mm	TR	1	-	6	

ABS

BLANCO

Fácil de instalar gracias a su sistema adhesivo con cinta 3M
Correa auto-ajustable
Cierre de manera segura sus armarios, cajones, etc.



Seguridad infantil



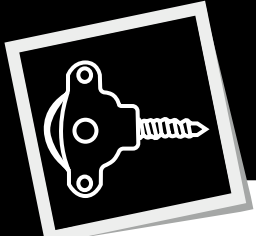

PROTECTOR TIRADOR ARMARIO SI8

	Código	8431488	Medida	Acabado				€uros
Blister	00467	004679	185x45 mm	BL	1	-	6	



Fácil de instalar
Horquilla ajustable
Cierre de manera segura sus armarios

Polipropileno

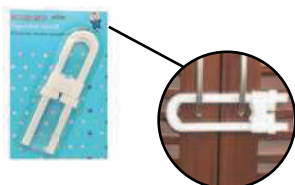

PROTECTOR ARMARIO SI9

	Código	8431488	Medida	Acabado				€uros
Blister	00468	004686	95 mm	BL	1	-	6	



Fácil de instalar gracias a su sistema adhesivo
Cierre de manera segura sus armarios

ABS



PROTECTOR CAJONES SI10

	Código	8431488	Medida	Acabado				€uros
Blister	00469	004693	70x40 mm	BL/AZ	1	-	6	



Fácil de instalar gracias a su sistema adhesivo
Cierre de manera segura sus cajones

ABS

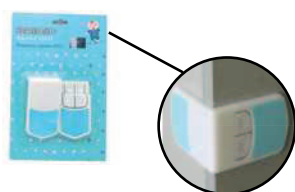

TOPE SALVA DEDOS SI11

	Código	8431488	Medida	Acabado				€uros
Blister	00470	004709	20 mm	BL	1	-	6	



Fácil de instalar: se fijan a presión en el canto de la puerta
Impide que la puerta se cierre completamente

Goma EVA



Seguridad infantil

PROTECTOR ENCHUFE GIRATORIO SI12

	Código	8431488	Medida	Acabado				€uros
Blister	00471	004716	30x35 mm	BL	6	-	6	

ABS



BLANCO

Fácil de instalar, permite la utilización del enchufe con normalidad
Impide accidentes con la corriente eléctrica



PROTECTOR ENCHUFE FIJO SI13

	Código	8431488	Medida	Acabado				€uros
Blister	00472	004723	32x35 mm	BL	6	-	6	

ABS



BLANCO

Fácil de instalar, es necesario retirar el protector para la utilización
del enchufe con normalidad. Impide accidentes con la corriente eléctrica



TOPE PUERTA CUÑA SI15

	Código	8431488	Medida	Acabado				€uros
Blister	00473	004730	113x45 mm	BL	1	-	6	

ABS



BLANCO

Fácil de instalar. Incluye colgador para poderlo dejar en la manivela
de la puerta. Impide que la puerta se cierre completamente



SEGURO VENTANA CORREDERA SI14

	Código	8431488	Medida	Acabado				€uros
Blister	00474	004747	19x19 mm	LT	4	-	6	

Latón



LATÓN

Fácil de colocar, mediante su sistema especial de tornillería (incluido)
Cierre de manera segura las ventanas y puertas correderas



Seguridad infantil

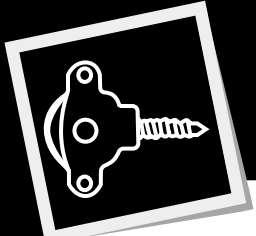

CANDADO ARCO NORMAL CN1



13234-13235-13236: Un cierre

13237-13238-13239-13240: Doble cierre

	Código	8431488	Medida A	Acabado				€uros
Caja	13234	132341	15 mm	LT	-	12	600	
	13235	132358	20 mm	LT	-	12	600	
	13236	132365	25 mm	LT	-	12	360	
	13237	132372	30 mm	LT	-	6	240	
	13238	132389	40 mm	LT	-	6	120	
	13239	132396	50 mm	LT	-	6	72	
	13240	132402	60 mm	LT	-	6	48	
Blister	13241	132419	15 mm	LT	1	-	6	
	13242	132426	20 mm	LT	1	-	6	
	13243	132433	25 mm	LT	1	-	6	
	13244	132440	30 mm	LT	1	-	6	
	13245	132457	40 mm	LT	1	-	6	
	13246	132464	50 mm	LT	1	-	6	
	13247	132471	60 mm	LT	1	-	6	

Presentación en caja individual

Latón



CANDADO ARCO NORMAL CN1 (LLAVES IGUALES)



13248-13249-13250: Un cierre

13251-13252-13253-13254: Doble cierre

	Código	8431488	Medida A	Acabado				€uros
Caja	13248	132488	15 mm	LT	-	12	600	
	13249	132495	20 mm	LT	-	12	600	
	13250	132501	25 mm	LT	-	12	360	
	13251	132518	30 mm	LT	-	6	240	
	13252	132525	40 mm	LT	-	6	120	
	13253	132532	50 mm	LT	-	6	72	
	13254	132549	60 mm	LT	-	6	48	
Blister	13255	132556	15 mm	LT	3	-	6	
	13256	132563	20 mm	LT	3	-	6	
	13257	132570	25 mm	LT	3	-	6	

Presentación en caja individual

Latón



CANDADO ARCO NORMAL CN4



Doble cierre

	Código	8431488	Medida A	Acabado				€uros
Blister	13282	132822	30 mm	INOX	1	-	6	
	13283	132839	40 mm	INOX	1	-	6	
	13284	132846	50 mm	INOX	1	-	6	

Acero Inoxidable



CANDADO ARCO LARGO CN2

	Código	8431488	Medida A	Acabado			€uros
Caja	13258	132587	20 mm	LT	-	12	480
	13259	132594	25 mm	LT	-	12	240
	13260	132600	30 mm	LT	-	6	180
	13261	132617	40 mm	LT	-	6	120
	13262	132624	50 mm	LT	-	6	60
	13263	132631	60 mm	LT	-	6	48
Blister	13264	132648	20 mm	LT	1	-	6
	13265	132655	25 mm	LT	1	-	6
	13266	132662	30 mm	LT	1	-	6
	13267	132679	40 mm	LT	1	-	6
	13268	132686	50 mm	LT	1	-	6
	13269	132693	60 mm	LT	1	-	6

Latón



Presentación en caja individual

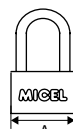

13258-13259: Un cierre

13260-13261-13262-13263: Doble cierre

CANDADO ARCO LARGO CN2 (LLAVES IGUALES)

	Código	8431488	Medida A	Acabado			€uros
Caja	13270	132709	30 mm	LT	-	6	180
	13271	132716	40 mm	LT	-	6	120
	13272	132723	50 mm	LT	-	6	60

Latón



Presentación en caja individual



Doble cierrel

CANDADO RECTANGULAR CN3

	Código	8431488	Medida A	Acabado			€uros
Caja	13273	132730	60 mm	LT	-	6	60
	13274	132747	70 mm	LT	-	6	48
	13275	132754	90 mm	LT	-	6	24
Blister	13276	132761	60 mm	LT	1	-	6
	13277	132778	70 mm	LT	1	-	6
	13278	132785	90 mm	LT	1	-	6

Latón



Presentación en caja individual

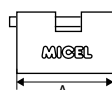

CANDADO RECTANGULAR CN3 (LLAVES IGUALES)

	Código	8431488	Medida A	Acabado			€uros
Caja	13279	132792	60 mm	LT	-	6	60
	13280	132808	70 mm	LT	-	6	48
	13281	132815	90 mm	LT	-	6	24

Latón



Presentación en caja individual

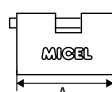

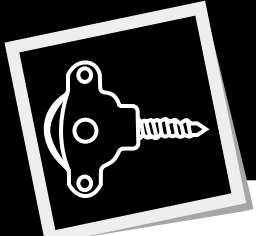

13285-13286: 3 combinaciones

13287: 4 combinaciones

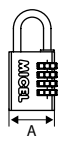

CANDADO COMBINACIÓN CN5

	Código	8431488	Medida A	Acabado				€uros
Blister	13285	132853	20 mm	LT	1	-	6	
	13286	132860	30 mm	LT	1	-	6	
	13287	132877	40 mm	LT	1	-	6	

Latón



LATÓN



20 mm: 3 combinaciones

30 y 40 mm: 4 combinaciones

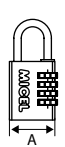

CANDADO COMBINACIÓN CN8

	Código	8431488	Medida A	Acabado				€uros
Blister	13347	133478	20 mm	AZUL	1	-	6	
	13348	133485	20 mm	ROJO	1	-	6	
	13349	133492	20 mm	NEGRO	1	-	6	
	13357	133577	20 mm	VERDE	1	-	6	
	13358	133584	20 mm	MORADO	1	-	6	
	13350	133508	30 mm	AZUL	1	-	6	
	13351	133515	30 mm	ROJO	1	-	6	
	13352	133522	30 mm	NEGRO	1	-	6	
	13359	133591	30 mm	VERDE	1	-	6	
	13360	133607	30 mm	MORADO	1	-	6	
	13353	133539	40 mm	AZUL	1	-	6	
	13354	133546	40 mm	ROJO	1	-	6	
	13355	133553	40 mm	NEGRO	1	-	6	
	13361	133614	40 mm	VERDE	1	-	6	
	13362	133621	40 mm	MORADO	1	-	6	

Aluminio



CANDADO COMBINACIÓN CABLE CN6

	Código	8431488	Medida	Acabado				€uros
Blister	13288	132884	20 mm	SURTIDO	1	-	6	



Zamak



SURTIDO



LLAVE BRUTO CANDADO CN1/CN2

	Código	8431488	Medida	Acabado				€uros
Caja	13289	132891	15 mm	NI	-	50	1250	
	13290	132907	20-25 mm	NI	-	50	1250	
	13292	132921	30 mm	NI	-	50	1250	
	13293	132938	40 mm	NI	-	50	1250	

Latón





LLAVE BRUTO CANDADO CN1/CN2/CN3

	Código	8431488	Medida	Acabado				€uros
Caja	13294	132945	50-60 mm	NI	-	50	1250	

Latón



LLAVE BRUTO CANDADO CN3

	Código	8431488	Medida	Acabado				€uros
Caja	13356	133560	70-90 mm	NI	-	25	625	

Latón



LLAVE BRUTO CANDADO CN4

	Código	8431488	Medida	Acabado				€uros
Caja	13291	132914	30 mm	NI	-	25	625	
	13295	132952	40 mm	NI	-	25	625	
	13297	132976	50 mm	NI	-	25	625	

Latón



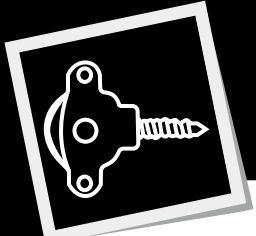

CANDADO FURGONETA CN7

	Código	8431488	Medida	Acabado				€uros
<i>Blister</i>	13298	132983	73 mm	CB	1	-	10	

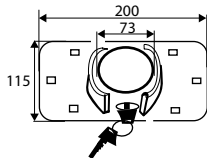

Acero #45



- Cuerpo de cerradura de acero #45 reforzado y cromado
- Cilindro de latón con 6 pitones
- 2 Partes del cerrojo para puertas de furgonetas en acero cromado
- Sin resortes que puedan oxidarse
- Sin grilletes exteriores cortantes
- 2 Llaves



KIT 2 CANDADOS FURGONETA CN7 (LLAVES IGUALES)

	Código	8431488	Medida	Acabado				€uros
<i>Caja</i>	13363	133638	73 mm	CB	-	1	6	

Acero #45



CERRADURA P/CANDADO FURGONETA CN7

	Código	8431488	Medida	Acabado				€uros
<i>Blister</i>	13364	133645	73 mm	CB	1	-	10	

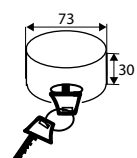

Acero #45



LLAVE BRUTO CANDADO FURGONETA CN7

	Código	8431488	Medida	Acabado				€uros
<i>Caja</i>	13346	133461	106x67 mm	LT	-	10	100	



Latón



GUARDALLAVES CAJA C/COMBINACIÓN CN9

	Código	8431488	Medida	Acabado				€uros
Caja	13302	133027	110x90 mm	GR/NE	-	1	30	

Acero

GRIS/
NEGRO

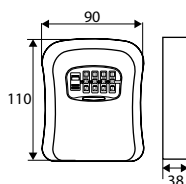

GUARDALLAVES CAJA C/COMBINACIÓN CN11

	Código	8431488	Medida	Acabado				€uros
Caja	13344	133447	145x105 mm	GR/NE	-	1	20	

Acero

GRIS/
NEGRO

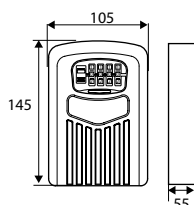

GUARDALLAVES CANDADO C/COMBINACIÓN CN10

	Código	8431488	Medida	Acabado				€uros
Caja	13303	133034	145x63x20 mm	GR/NE	-	1	50	

Acero

GRIS/
NEGRO

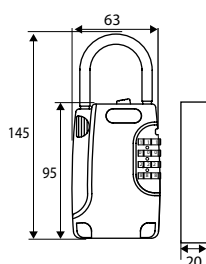

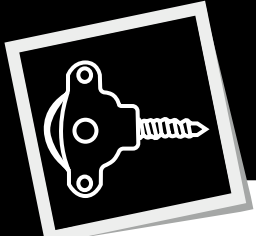

GUARDAPARKING VERTICAL GPK1



	Código	8431488	Medida	Acabado				€uros
Caja	13296	132969	600 mm	AMARILLO	-	1	-	

Cierre mediante cilindro

Acero

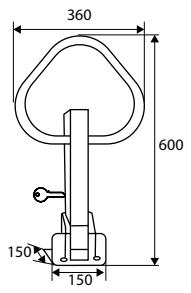

CADENA RECTA LISA CDN1



	Código	8431488	Medida	Acabado				€uros
Rollo	30537	305370	2x12,5x60 mts	LTD	-	1	-	
	30538	305387	2x12,5x60 mts	NI	-	1	-	
	30539	305394	2x12,5x60 mts	BR	-	1	-	
	30540	305400	2x12,5x60 mts	NE	-	1	-	
	30541	305417	3,4x43x20 mts	LTD	-	1	-	
	30542	305424	3,4x43x20 mts	NE	-	1	-	

30537-30538-30539-30540: Rollo de 60 mts
30541-30542: Rollo de 20 mts

Acero

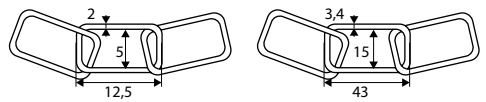

30537-30538-30539-30540

30541-30542



CADENA OVAL LISA CDN2



	Código	8431488	Medida	Acabado				€uros
Rollo	30543	305431	2,8x17x30 mts	LTD	-	1	-	
	30544	305448	2,8x17x30 mts	NE	-	1	-	

Rollo de 30 mts

Acero

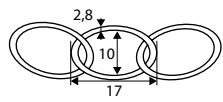

CADENA RECTA TORCIDA CDN3

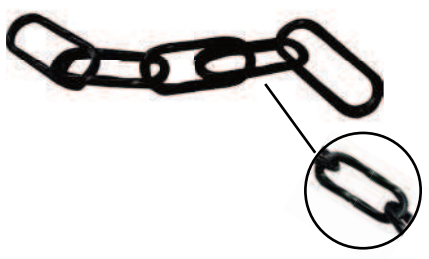

	Código	8431488	Medida	Acabado				€uros
Rollo	30545	305455	3,5x38x20 mts	LTD	-	1	-	
	30546	305462	3,5x38x20 mts	BR	-	1	-	
	30547	305479	3,5x38x20 mts	NE	-	1	-	

Rollo de 20 mts

Acero

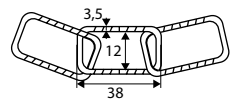

CADENA RECTA GRABADA CDN4

	Código	8431488	Medida	Acabado				€uros
Rollo	30548	305486	4x29x20 mts	LTD	-	1	-	
	30549	305493	4x29x20 mts	NI	-	1	-	

Acero

Rollo de 20 mts

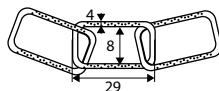

CADENA REDONDA GRABADA CDN5

	Código	8431488	Medida	Acabado				€uros
Caja	30550	305509	3,4x43x1 mt	LTD	-	10	30	
	30551	305516	3,4x43x1 mt	NI	-	10	30	
	30552	305523	3,4x43x1 mt	NE	-	10	30	
	92414	924144	3,4x43x1 mt	LTD	2	-	10	
	92415	924151	3,4x43x1 mt	NI	2	-	10	
	92416	944168	3,4x43x1 mt	NE	2	-	10	

Acero

Tira de 1 mt

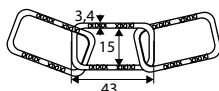

CADENA TORCIDA LISA CDN6

	Código	8431488	Medida	Acabado				€uros
Caja	30553	305530	2x10x30 mts	LTD	-	1	5	
	30554	305547	2x10x30 mts	NI	-	1	5	

Acero

Tira de 30 mts

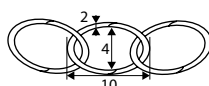

CADENA CATEDRAL CDN7

	Código	8431488	Medida	Acabado				€uros
Rollo	30557	305578	2,2x24x30 mts	LTD	-	1	-	

Acero

Rollo de 30 mts

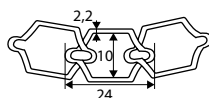

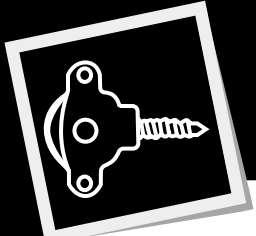

CADENA BOLAS CDN8

	Código	8431488	Medida	Acabado				€uros
Rollo	30558	305585	3,2x50 mts	CB	-	1	-	
	30559	305592	4x50 mts	CB	-	1	-	

1 Rollo de 50 mts

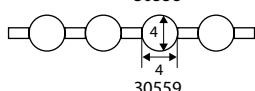
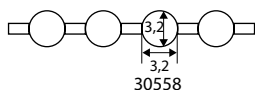

Latón

CROMO BRILLO

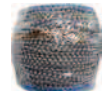

ENGANCHE CADENA BOLAS CDN8

	Código	8431488	Medida	Acabado				€uros
Caja	30560	305608	3,2 mm	CB	-	100	2500	
	30561	305615	4 mm	CB	-	100	2500	

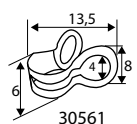
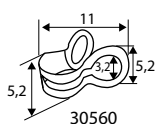

Acero

CROMO BRILLO

ENGANCHE LLAVERO CADENA CDN8

	Código	8431488	Medida	Acabado				€uros
Caja	30562	305622	3,2 mm	CB	-	100	2500	
	30563	305639	4 mm	CB	-	100	2500	

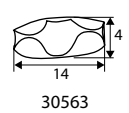
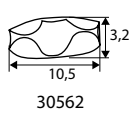

Acero

CROMO BRILLO

LLAVERO ANILLA CADENA CDN8

	Código	8431488	Medida	Acabado				€uros
Caja	30564	305646	18 mm	CB	-	100	2500	

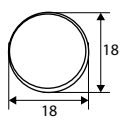

Acero

CROMO BRILLO

CADENA BOLAS MONTADA CDN8

	Código	8431488	Medida	Acabado				€uros
Caja	30565	305653	3,2x250 mm	CB	-	25	625	
	30566	305660	4x400 mm	CB	-	25	625	
	92408	924083	3,2x250 mm	CB	1	-	10	
	92409	924090	4x400 mm	CB	1	-	10	

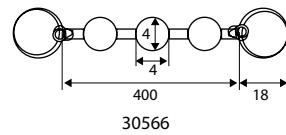
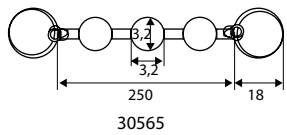

Latón

CROMO BRILLO

TENEDERO PARED TND1

	Código	8431488	Medida	Acabado			€uros
	89083	890838	550x20 mm	BL	-	1	20
	89084	890845	550x20 mm	NE	-	1	20

Acero

Precio unitario

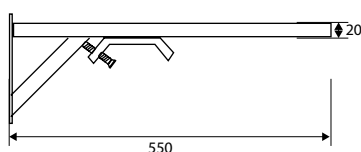

TENEDERO BalcÓN TND2

	Código	8431488	Medida	Acabado			€uros
	89085	890852	550x20 mm	BL	-	1	20
	89086	890869	550x20 mm	NE	-	1	20

Acero

Precio unitario

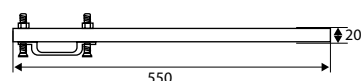

POLEA TENDER C/GANCHO POL5

	Código	8431488	Medida	Acabado			€uros
Caja	89071	890715	40 mm	ZN	-	25	250
Blistar	91888	918884	40 mm	ZN	2	-	10

Zamak

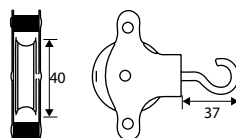

POLEA TENDER C/GANCHO POL6

	Código	8431488	Medida	Acabado			€uros
Caja	89070	890708	40 mm	ZN	-	25	250
Blistar	91887	918877	40 mm	ZN	2	-	10

Nylon

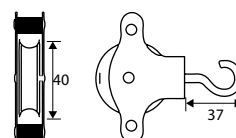

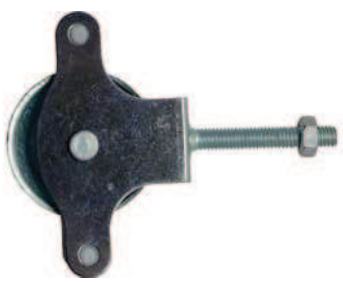
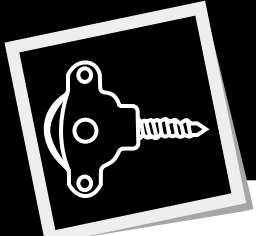

POLEA TENDER C/TUERCA POL1

	Código	8431488	Medida A	Acabado				€uros
Caja	89021	890210	40 mm	ZN	-	25	250	
	89022	890227	60 mm	ZN	-	25	250	
Blister	91156	911564	40 mm	ZN	2	-	10	
	91157	911571	60 mm	ZN	2	-	10	

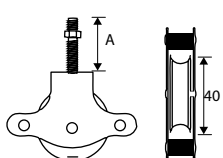

Zamak

ZINCADO

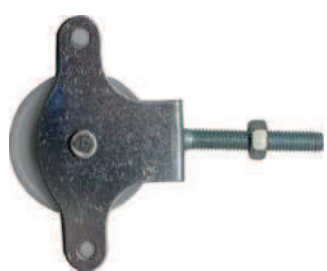

POLEA TENDER C/TUERCA POL2

	Código	8431488	Medida A	Acabado				€uros
Caja	89019	890197	40 mm	ZN	-	25	250	
	89020	890203	60 mm	ZN	-	25	250	
Blister	91154	911540	40 mm	ZN	2	-	10	
	91155	911557	60 mm	ZN	2	-	10	

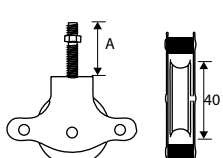

Nylon

ZINCADO

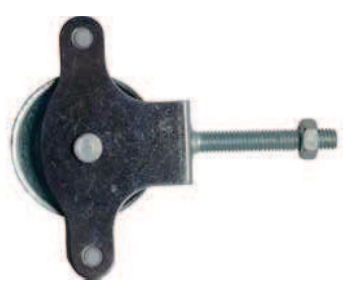

POLEA TENDER C/TUERCA POL7

	Código	8431488	Medida	Acabado				€uros
Caja	89087	890876	40 mm	INOX	-	25	250	
Blister	92265	922652	40 mm	INOX	2	-	10	

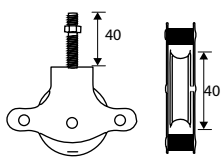

Acero Inoxidable

INOX

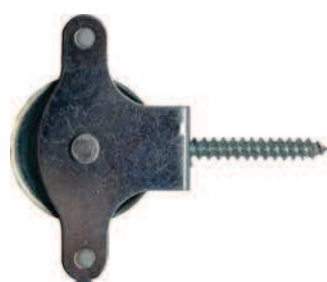

POLEA TENDER TORNILLO POL3

	Código	8431488	Medida	Acabado				€uros
Caja	89018	890180	40 mm	ZN	-	25	250	
Blister	91153	911533	40 mm	ZN	2	-	10	

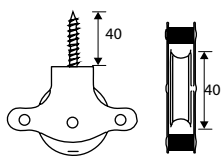

Zamak

ZINCADO

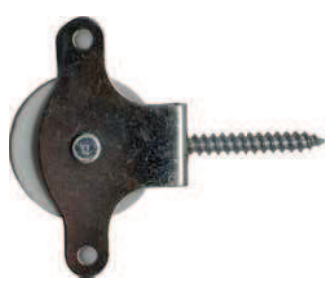

POLEA TENDER TORNILLO POL4

	Código	8431488	Medida	Acabado				€uros
Caja	89017	890173	40 mm	ZN	-	25	250	
Blister	91152	911526	40 mm	ZN	2	-	10	

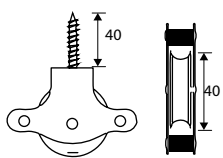

Nylon

ZINCADO

LLAVERO ANILLA LLV1

	Código	8431488	Medida A	Acabado				€uros
Caja	98616	986166	16 mm	NI	-	200	20000	
	98618	986180	18 mm	NI	-	200	10000	
	98620	986203	20 mm	NI	-	200	10000	
	98625	986258	25 mm	NI	-	200	6000	
	98630	986302	30 mm	NI	-	200	5000	
	98635	986357	35 mm	NI	-	200	2000	
Blister	90611	906119	16 mm	NI	15	-	10	
	90612	906126	18 mm	NI	15	-	10	
	90613	906133	20 mm	NI	15	-	10	
	90614	906140	25 mm	NI	15	-	10	
	90615	906157	30 mm	NI	15	-	10	
	90616	906164	35 mm	NI	15	-	10	

Acero



LLAVERO PORTAETIQUETAS PTQ2

	Código	8431488	Medida AxB	Acabado				€uros
Caja	98501	985015	58x22 mm	BLANCO	-	100	1000	
	98502	985022	58x22 mm	NEGRO	-	100	1000	
	98503	985039	58x22 mm	SURTIDO	-	100	1000	
	98504	985046	58x22 mm	AMARILLO	-	100	1000	
	98505	985053	58x22 mm	ROJO	-	100	1000	
	98506	985060	58x22 mm	AZUL	-	100	1000	
	98507	985077	58x22 mm	NARANJA	-	100	1000	
	98508	985084	58x22 mm	VERDE	-	100	1000	
	98509	985091	58x22 mm	GRIS	-	100	1000	
Blister	90602	906027	58x22 mm	BLANCO	8	-	10	
	90603	906034	58x22 mm	NEGRO	8	-	10	
	90604	906041	58x22 mm	SURTIDO	8	-	10	
	90605	906058	58x22 mm	AMARILLO	8	-	10	
	90606	906065	58x22 mm	ROJO	8	-	10	
	90607	906072	58x22 mm	AZUL	8	-	10	
	90608	906089	58x22 mm	NARANJA	8	-	10	
	90609	906096	58x22 mm	VERDE	8	-	10	
	90610	906102	58x22 mm	GRIS	8	-	10	

Polietileno



CAJA LLAVERO PORTAETIQUETAS PTQ1

	Código	8431488	Medida	Acabado				€uros
Caja	98500	985008	58x22 mm	SURTIDO	-	1	5	

Polietileno



Contenido: 200 unidades



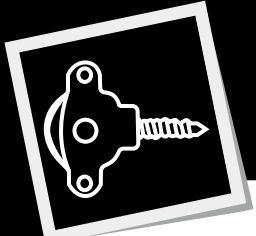

ANILLA P/LLAVE LLV3

	Código	8431488	Medida	Acabado				€uros
Caja	98498	984988	24 mm	SURTIDO	-	100	-	
Blister	91829	918297	24 mm	SURTIDO	10	-	10	

Polietileno

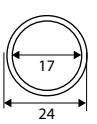

CAJA ANILLAS P/LLAVES LLV2

	Código	8431488	Medida	Acabado				€uros
Caja	98499	984995	24 mm	SURTIDO	-	1	5	

Contenido: 200 unidades

Polietileno

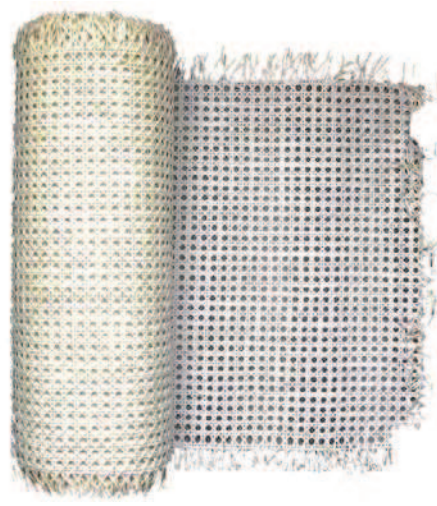

REJILLA VEGETAL RV1

	Código	8431488	Medida	Acabado				€uros
Rollo	97046	970462	46 cm	BE	-	1	-	
	97051	970516	51 cm	BE	-	1	-	
	97061	970615	61 cm	BE	-	1	-	
	97076	970769	76 cm	BE	-	1	-	
	97092	970929	92 cm	BE	-	1	-	

Rollos de 15 mts

Mimbres



MÉDULA P/REJILLA VEGETAL RV2

	Código	8431488	Medida	Acabado				€uros
Rollo	97035	970356	3,5 mm	BE	-	1	-	

Presentación en paquetes de 1 kg, conteniendo 75 -78 tiras de 3 a 5 mts. aproximadamente

Mimbres



CAJA CHINCHETAS TCH2

	Código	8431488	Medida	Acabado				€uros
Caja	11720	117201	10 mm	SURTIDO	-	1	50	
	11722	117225	10 mm	NI	-	1	50	
Blister	91225	912257	10 mm	SURTIDO	50	-	10	
	91226	912264	10 mm	NI	50	-	10	

Acero

Contenido: 50 unidades



TACHUELA PLANA TCH1

	Código	8431488	Medida AxB	Acabado				€uros
Caja	11705	117058	8x14 mm	LTD	-	500	12500	
	11706	117065	8x14 mm	CU	-	500	12500	
	11707	117072	8x14 mm	PV	-	500	12500	
	11708	117089	10x15 mm	LTD	-	500	12500	
	11709	117096	10x15 mm	CU	-	500	12500	
	11710	117102	10x15 mm	PV	-	500	12500	
	11711	117119	10x15 mm	BL	-	500	12500	
	11712	117126	10x15 mm	NE	-	500	12500	
	11717	117171	12x16 mm	LTD	-	500	5000	
	11718	117188	12x16 mm	CU	-	500	5000	
	11719	117195	12x16 mm	PV	-	500	5000	
Blister	91195	911953	8x14 mm	LTD	25	-	10	
	91196	911960	8x14 mm	CU	25	-	10	
	91197	911977	8x14 mm	PV	25	-	10	
	91198	911984	10x15 mm	LTD	25	-	10	
	91199	911991	10x15 mm	CU	25	-	10	
	91200	912004	10x15 mm	PV	25	-	10	
	91201	911201	10x15 mm	BL	25	-	10	
	91202	912028	10x15 mm	NE	25	-	10	
	91207	912073	12x16 mm	LTD	25	-	10	
	91208	912080	12x16 mm	CU	25	-	10	
	91209	912097	12x16 mm	PV	25	-	10	

Acero



CASCABEL LATÓN CCB1

	Código	8431488	Medida A	Acabado				€uros
Caja	11833	118338	8 mm	NI	-	100	2500	
	11834	118345	11 mm	NI	-	100	2500	
	11835	118352	13 mm	NI	-	100	2500	
	11836	118369	15 mm	NI	-	100	1000	
	11837	118376	17 mm	NI	-	50	500	
	11838	118383	20 mm	NI	-	50	250	
Blister	92254	922546	8 mm	NI	20	-	10	
	92255	922553	11 mm	NI	18	-	10	
	92256	922560	13 mm	NI	16	-	10	
	92257	922577	15 mm	NI	14	-	10	
	92258	922584	17 mm	NI	12	-	10	
	92259	922591	20 mm	NI	10	-	10	

Latón



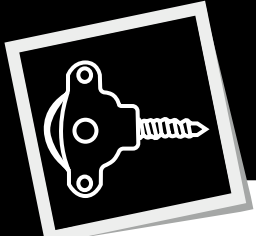

LLAVE MULTIPLE CONTADOR LLV4

	Código	8431488	Medida	Acabado				€uros
Caja	13367	133676	72x72 mm	NI	-	10	240	
Blister	92417	924175	72x72 mm	NI	1	-	10	

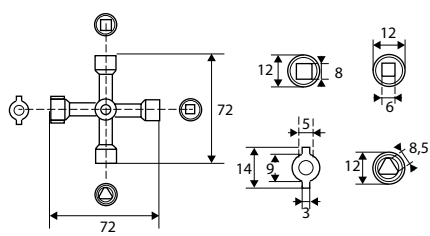

Zamak
●
NIQUEL



PAPEL MAGNÉTICO FOTOS IM36

	Código	8431488	Medida AxB	Acabado				€uros
Blister	10422	104225	150x100 mm	NE	10	-	10	
	10423	104232	250x200 mm	NE	5	-	10	

Convierte tus fotos en imanes

Ferrita
●
NEGRO

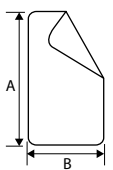

1 Retira el adhesivo

2 Pega tu foto

3 ¡Ya tienes tu foto imantada!

PORTAETIQUETAS ESTANFERÍA MAGNÉTICO IM37

	Código	8431488	Medida	Acabado				€uros
Caja	10424	104249	105x50 mm	NE	-	30	150	

Incluye etiqueta y plástico protector

Ferrita
●
NEGRO

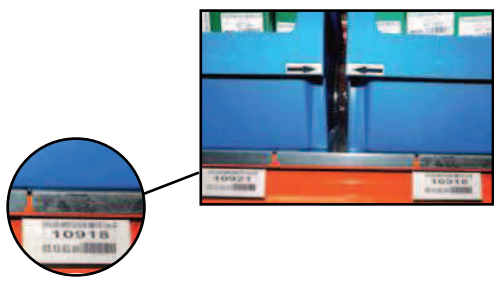
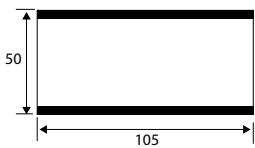

BRIMIC

SOLUCIONES
PENSADAS
A LA MEDIDA
DE TU PUNTO DE VENTA



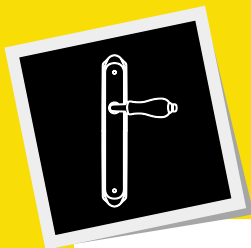

SOLUCIÓN MANILLAS

CÓDIGO	DESCRIPCIÓN	CANTIDAD
FILA 1		
17021	BL JGO MANILLA 1777 LTD	4
17017	BL JGO MANILLA 202 CU	4
17015	BL JGO MANILLA 202 BI	4
17016	BL JGO MANILLA 202 NS	4
17031	BL JGO MANILLA 707 LS	4
17032	BL JGO MANILLA 707 NS	4
FILA 2		
17028	BL JGO MANILLA 989 NS	4
17013	BL JGO MANILLA 1666 LTD	4
17024	BL JGO MANILLA 919 CU	4
17005	BL JGO MANILLA PORCELANA 787 CU	4
17042	BL JGO MANILLA 606 NS	4
17051	BL JGO MANILLA 272 NE	4
FILA 3		
17003	BL JGO ROSETA L CURVA 575 IN	4
17004	BL JGO ROSETA U 585 IN	4
17033	BL JGO ROSETA 707 LS	4
17034	BL JGO ROSETA 707 NS	4
17038	BL JGO ROSETA 404 NS	4
17035	BL JGO ROSETA CUADRADA 868 CN	4
FILA 4		
17026	BL JGO ROSETA 919 CU	4
17039	BL JGO ROSETA 909 NS	4
17075	BL JGO ROSETA 909 LS	4
17008	BL JGO ROSETA PORCELANA 787 CU	4
17046	BL JGO ROSETA 606 NS	4
17050	BL JGO ROSETA CUADRADA 616 NS	4
FILA 5		
11153	BL POMO PUERTA BOLA ENTRADA PP7 LP	3
11154	BL POMO PUERTA BOLA ENTRADA PP7 IN	3
90114	BL CUADRADILLO CDD1 6x90mm ZN	6
17005	BL BOCALLAVE PERA 707 50mm LS	5
17069	BL MULETILLA MANILLA C/DESBLOQUEO 10098 LP	5
17071	BL MULETILLA MANILLA C/DESBLOQUEO 10098 NS	5
17070	BL MULETILLA MANILLA C/DESBLOQUEO 10098 CU	5
17073	BL MULETILLA MANILLA C/DESBLOQUEO 10098 NE	5
17124	BL JGO MANILLA P/METALICA 232 25-38mm NE	4

CÓDIGO	DESCRIPCIÓN	CANTIDAD
FILA 6		
11155	BL POMO PUERTA BOLA BAÑO PP7 LP	3
11156	BL POMO PUERTA BOLA BAÑO PP7 IN	3
90115	BL CUADRADILLO CDD1 8x90mm ZN	6
17056	BL BOCALLAVE PERA 707 50mm NS	5
90116	BL REDUCTOR CUADRADILLO CDD7 8-6mm ZN	6
17057	BL BOCALLAVE PERA 787 50mm CU	5
17061	BL MULETILLA ROSETA 707 35mm LS	5
17062	BL MULETILLA ROSETA 707 35mm NS	5
17064	BL MULETILLA ROSETA 787 35mm CU	5
FILA 7		
11159	BL POMO PUERTA BOLA PASO PP7 LP	3
11160	BL POMO PUERTA BOLA PASO PP7 IN	3
17139	BL JGO MANILLA C/BOCALLAVE 704 NE	4
17140	BL JGO MANILLA CIEGA 704 NE	4
17141	BL JGO MANILLA C/POMO 704 NE	4
BANDEJA INFERIOR		
10008	POMO PUERTA AROS PP1 70mm LP	2
10009	POMO PUERTA LISO PP2 70mm LP	2
10240	POMO PUERTA LISO PP2 70mm CU	2
11092	POMO PUERTA LISO PP2 70mm NE	2
10239	POMO PUERTA LISO PP2 70mm NS	2
11904	POMO PUERTA LISO PP2 70mm IN	2
10620	MANILLON TORNEADO MN4 300mm NS	2
10006	MANILLON TORNEADO MN4 300mm LP	2
27216	MANILLON PLACA 272 NE	2
28200	MANILLON ROSETA L CURVA 575 200x19mm IN	2
16666	MANILLON PLACA 1666 LTD	2
17776	MANILLON PLACA 1777 LTD	2
02026	MANILLON PLACA 202 BI	2
02027	MANILLON PLACA 202 NS	2

1 mt



BRIMIC

SOLUCIÓN MANILLAS

61 referencias
218 unidades

FILA 1

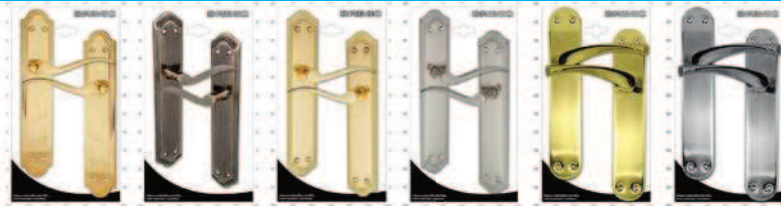

17021 17017 17015 17016 17031 17032

FILA 2



17028 17013 17024 17005 17042 17051

FILA 3

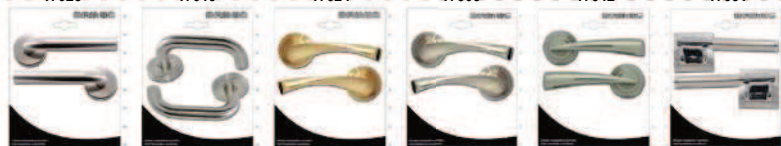

17003 17004 17033 17034 17038 17035

FILA 4

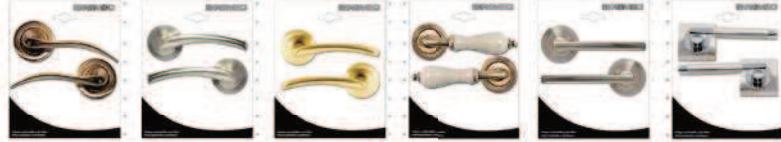

17026 17039 17075 17008 17046 17050

FILA 5



11153 11154 90114 17005 17069 17071 17070 17073 17124

FILA 6



11155 11156 90115 17056 17061 17062 17064 90116 17057

FILA 7



11159 11160 17139 17140 17141

BANDEJA INFERIOR

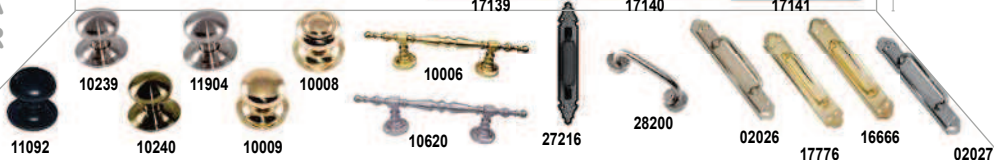

11092 10239 11904 10008 10006 10620 27216 28200 02026 17776 16666 02027

2 mts

SOLUCIONES BRIMIC

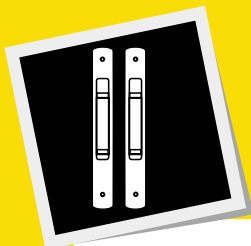

SOLUCIÓN ALUMINIO

CÓDIGO	DESCRIPCIÓN	CANTIDAD
FILA 1		
17083	BL JGO MANILLA 6802 ALUM BL	3
17084	BL JGO MANILLA 6802 ALUM NE	3
17087	BL CIERRE PRESION IZDA 6801 ALUM BL	3
17086	BL CIERRE PRESION DCHA 6801 ALUM BL	3
17089	BL CIERRE PRESION IZDA 6801 ALUM NE	3
17088	BL CIERRE PRESION DCHA 6801 ALUM NE	3
FILA 2		
17098	BL JGO MANILLA 702 ALUM BL	3
17099	BL JGO MANILLA 702 ALUM NE	3
17100	BL JGO MANILLA 702 ALUM PL	3
17080	BL JGO MANILLA 6800 ALUM BL	3
17081	BL JGO MANILLA 6800 ALUM NE	3
17082	BL JGO MANILLA 6800 ALUM PL	3
FILA 3		
17106	BL ASA PLACA RECTA 6804 ALUM BL	3
17107	BL ASA PLACA RECTA 6804 ALUM NE	3
17108	BL ASA PLACA RECTA 6804 ALUM PL	3
17109	BL ASA PLACA REDONDA 6803 ALUM BL	3
17110	BL ASA PLACA REDONDA 6803 ALUM NE	3
17111	BL ASA PLACA REDONDA 6803 ALUM PL	3
FILA 4		
17103	BL POMO RECUPERABLE 6807 ALUM BL	3
17104	BL POMO RECUPERABLE 6807 ALUM NE	3
91802	BL CIERRE CORREDERA 6820 ALUM BL	2
91803	BL CIERRE CORREDERA 6820 ALUM NE	2
91804	BL CIERRE CORREDERA 6821 ALUM BL	2
91805	BL CIERRE CORREDERA 6821 ALUM NE	2
92169	BL CIERRE CORREDERA LL/I 6826 ALUM BL	2
92170	BL CIERRE CORREDERA LL/I 6826 ALUM NE	2
FILA 5		
91487	BL CERRADERO LENGÜETA 6818-22 ZN	6
91488	BL CERRADERO LENGÜETA 6818-25 ZN	6
91964	BL CERRADERO LENGÜETA 6818-01 ZN	6
91483	BL CONTRACIERRE ZAMAK 6819-01 ZN	6
91484	BL CONTRACIERRE ZAMAK 6819-02 ZN	6
91485	BL CONTRACIERRE ZAMAK 6819-05 ZN	6
91486	BL CONTRACIERRE ZAMAK 6819-12 BC	6
91960	BL CONTRACIERRE ZAMAK 6819-00 NE	6
91335	BL RODAMIENTO ENDASA CLL RD10 BL	6
91334	BL RODAMIENTO 172 RD7 BL	6
91333	BL RODAMIENTO INASA 163 RD9 BL	6
91339	BL RODAMIENTO CO-22 RD8 BL	6
91327	BL RODAMIENTO INASA 151 RD12 ZN	6
91897	BL RODAMIENTO CO-1B RD31 AL	6
91336	BL RODAMIENTO CLL/104 RD18 BC	6
91329	BL RODAMIENTO 158 RD14 BC	6
91332	BL RODAMIENTO CLIMALIT 177 RD17 ZN	6
91331	BL RODAMIENTO INASA 162 RD16 ZN	6

CÓDIGO	DESCRIPCIÓN	CANTIDAD
FILA 6		
91796	BL RODAMIENTO MAMPARA RD1 16mm NE	6
91337	BL RODAMIENTO MAMPARA RD1 20mm NE	6
91338	BL RODAMIENTO MAMPARA RD1 26mm NE	6
91797	BL RODAMIENTO MAMPARA TUBO RD2 22mm BL	6
91798	BL RODAMIENTO MAMPARA TUBO RD2 24mm BL	6
91799	BL RODAMIENTO MAMPARA ART RD3 26mm BL	6
91901	BL RODAMIENTO ALUPRON 21 RD21 NE	6
91800	BL RODAMIENTO ALUGOM 400 RD20 NE	6
91465	BL GOLPETE 6810 ALUM BL	6
91466	BL GOLPETE 6810 ALUM NE	6
91462	BL PASADOR RULETA 6825 ALUM BL	6
91463	BL PASADOR RULETA 6825 ALUM NE	6
FILA 7		
91471	BL BISAGRA EU DCHA 6812 ALUM BL	4
91472	BL BISAGRA EU IZDA 6812 ALUM BL	4
91473	BL BISAGRA EU DCHA 6812 ALUM NE	4
91474	BL BISAGRA EU IZDA 6812 ALUM NE	4
91477	BL BISAGRA 40/20 DCHA 6813 ALUM BL	4
91478	BL BISAGRA 40/20 IZDA 6813 ALUM BL	4
91479	BL BISAGRA 40/20 DCHA 6813 ALUM NE	4
91480	BL BISAGRA 40/20 IZDA 6813 ALUM NE	4
FILA 8		
91810	BL CREMONA 2 PATILLAS 6814 ALUM BL	2
91811	BL CREMONA 2 PATILLAS 6814 ALUM NE	2
91812	BL CREMONA 2 PATILLAS 6815 ALUM BL	2
91813	BL CREMONA 2 PATILLAS 6815 ALUM NE	2
91934	BL CIERRE CORREDERA LL/I 6847 ALUM BL	2
91935	BL CIERRE CORREDERA LL/I 6847 ALUM NE	2

1 mt



BRIMIC

SOLUCIÓN ALUMINIO

70 referencias
296 unidades

FILA 1

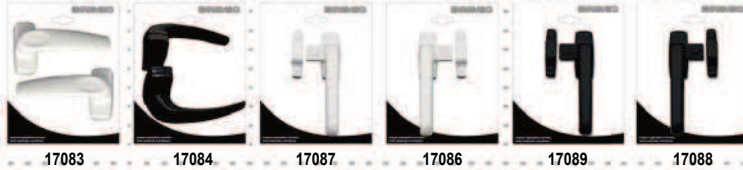

FILA 2

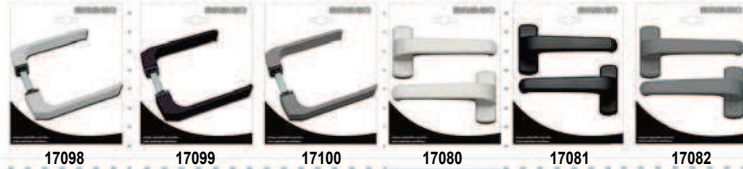

FILA 3



FILA 4



FILA 5



FILA 6



FILA 7



FILA 8



2 mts

SOLUCIONES BRIMIC



SOLUCIÓN COMPLEMENTOS PUERTA

CÓDIGO	DESCRIPCIÓN	CANTIDAD
FILA 1		
10260	BL NUMERO LATON 0 NM1 100mm LP	5
10261	BL NUMERO LATON 1 NM1 100mm LP	5
10262	BL NUMERO LATON 2 NM1 100mm LP	5
10263	BL NUMERO LATON 3 NM1 100mm LP	5
10264	BL NUMERO LATON 4 NM1 100mm LP	5
10265	BL NUMERO LATON 5 NM1 100mm LP	5
10266	BL NUMERO LATON 6-9 NM1 100mm LP	5
10267	BL NUMERO LATON 7 NM1 100mm LP	5
10268	BL NUMERO LATON 8 NM1 100mm LP	5
FILA 2		
10300	BL NUMERO LATON 0 NM1 100mm NS	5
10301	BL NUMERO LATON 1 NM1 100mm NS	5
10302	BL NUMERO LATON 2 NM1 100mm NS	5
10303	BL NUMERO LATON 3 NM1 100mm NS	5
10304	BL NUMERO LATON 4 NM1 100mm NS	5
10305	BL NUMERO LATON 5 NM1 100mm NS	5
10306	BL NUMERO LATON 6-9 NM1 100mm NS	5
10307	BL NUMERO LATON 7 NM1 100mm NS	5
10308	BL NUMERO LATON 8 NM1 100mm NS	5
FILA 3		
10271	BL LETRA LATON A LTR1 100mm LP	5
10272	BL LETRA LATON B LTR1 100mm LP	5
10273	BL LETRA LATON C LTR1 100mm LP	5
10274	BL LETRA LATON D LTR1 100mm LP	5
10275	BL LETRA LATON E LTR1 100mm LP	5
10311	BL LETRA LATON A LTR1 100mm NS	5
10312	BL LETRA LATON B LTR1 100mm NS	5
10313	BL LETRA LATON C LTR1 100mm NS	5
10314	BL LETRA LATON D LTR1 100mm NS	5
FILA 4		
91267	BL CILINDRO SEGURIDAD CS2 L13 30x30mm NI	6
91263	BL CILINDRO SEGURIDAD CS2 L15 30x30mm LT	6
91264	BL CILINDRO SEGURIDAD CS2 L15 30x30mm NI	6
91257	BL CILINDRO SEGURIDAD CS2 L15 30x40mm LT	6
91255	BL CILINDRO SEGURIDAD CS2 L15 35x35mm LT	6
91285	BL CILINDRO SERRETA CS3 L13 30x30mm NI	6
91271	BL CILINDRO SERRETA CS3 L15 30x30mm LT	6
91272	BL CILINDRO SERRETA CS3 L15 30x30mm NI	6
91691	BL ESCUDO SEGURIDAD ES1 63mm LS	6
FILA 5		
91159	BL GARRA PRECERCO PRC3 85x17,5mm ZN	6
90197	BL CUÑA DE MADERA PRC4 75x35mm	6
91493	BL TOPE PUERTA CLASICO TP9 MA	6
91492	BL TOPE PUERTA CLASICO TP9 BL	6
90128	BL TOPE PUERTA LUX TALADRO TP1 NS	6
90127	BL TOPE PUERTA LUX TALADRO TP1 CB	6
90125	BL TOPE PUERTA LUX TALADRO TP1 OR	6
91495	BL TOPE PUERTA RETENEDOR TP10 MA	6
91494	BL TOPE PUERTA RETENEDOR TP10 BL	6
91692	BL ESCUDO SEGURIDAD ES1 63mm NS	6

CÓDIGO	DESCRIPCIÓN	CANTIDAD
FILA 6		
90176	BL PASADOR HIERRO PS1 30mm LTD	6
90178	BL PASADOR HIERRO PS1 40mm LTD	6
90179	BL PASADOR HIERRO PS1 50mm LTD	6
90180	BL PASADOR HIERRO PS1 60mm LTD	6
90171	BL PASADOR HIERRO PS1 30mm NI	6
90173	BL PASADOR HIERRO PS1 40mm NI	6
90174	BL PASADOR HIERRO PS1 50mm NI	6
90175	BL PASADOR HIERRO PS1 60mm NI	6
90160	BL RETENEDOR PIE PEQ RT3 130x25 PL	4
FILA 7		
90163	BL PASADOR ALUMINIO D8 PS5 50mm BL	6
91546	BL PASADOR ALUMINIO D8 PS5 50mm NE	6
90165	BL PASADOR ALUMINIO D8 PS5 50mm PL	6
90164	BL PASADOR ALUMINIO D8 PS5 100mm BL	6
91697	BL PASADOR ALUMINIO D8 PS5 100mm NE	6
90166	BL PASADOR ALUMINIO D8 PS5 100mm PL	6
90300	BL ALDABA CLASICA DCHA ADB1 60mm NI	6
90301	BL ALDABA CLASICA IZDA ADB1 60mm NI	6
90294	BL ALDABA CLASICA DCHA ADB1 60mm LTD	6
90295	BL ALDABA CLASICA IZDA ADB1 60mm LTD	6
91191	BL ALDABILLA RETENIDA ADB3 3x40mm ZN	6
91192	BL ALDABILLA RETENIDA ADB3 3,5x60mm ZN	6
91193	BL ALDABILLA RETENIDA ADB3 4x80mm ZN	6
91194	BL ALDABILLA RETENIDA ADB3 4x100mm ZN	6
91290	BL ALDABA BARCO ADB2 100mm LP	6
91293	BL ALDABA BARCO ADB2 100mm NS	6
FILA 8		
44245	BL PASADOR ZAMAK PS2 45mm NI	6
44145	BL PASADOR ZAMAK PS2 45mm LTD	6
91516	BL PASADOR FORJA PS11 40mm NE	6
91600	BL PASADOR RULETA PS4 40mm LTD	6
91601	BL PASADOR RULETA PS4 40mm CB	6
90114	BL CUADRADILLO CDD1 6x90mm ZN	6
90115	BL CUADRADILLO CDD1 8x90mm ZN	6
90116	BL REDUCTOR CUADRADILLO CDD7 8-6mm ZN	6
91296	BL PORTACANDADO CC10 75mm ZN	6
91297	BL PORTACANDADO CC10 100mm ZN	6
91298	BL PORTACANDADO CC10 120mm ZN	6
FILA 9		
90482	BL PLACA CIEGA PLP1 100x70mm LP	5
90484	BL PLACA CIEGA PLP1 100x70mm NS	5
90488	BL PLACA BOCALLAVE PLP2 100x70mm LP	5
90490	BL PLACA BOCALLAVE PLP2 100x70mm NS	5
30523	BL RETENEDOR PUERTA RT1 108x63mm LTD	5
30524	BL RETENEDOR PUERTA RT1 108x63mm NS	5
30503	BL RETENEDOR CADENILLA RT2 85x38mm LTD	5
30504	BL RETENEDOR CADENILLA RT2 85x38mm NI	5
FILA 10		
10167	MIRILLA DIGITAL MD1 ORO	2
10168	MIRILLA DIGITAL MD1 PLATA	2
90110	BL MIRILLA 14mm 180° MR1 35/60mm NS	6
90103	BL MIRILLA 14mm 180° MR1 35/60mm LTD	6
90650	BL LLAMADOR INGLES LLM1 200x90mm LP	3
90652	BL LLAMADOR INGLES LLM1 200x90mm NS	3
90181	BL PASADOR PORTACANDADO PS12 70mm BC	5
90182	BL PASADOR PORTACANDADO PS12 85mm BC	4

1 mt



BRIMIC

SOLUCIÓN COMPLEMENTOS PUERTA

98 referencias
534 unidades

FILA 1



FILA 2



FILA 3



FILA 4



FILA 5



FILA 6



FILA 7



FILA 8



FILA 9



FILA 10



2 mts

SOLUCIONES BRIMIC

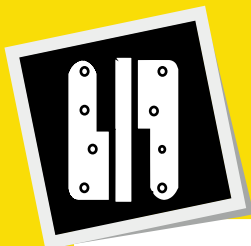

SOLUCIÓN BISAGRAS Y PICAPORTES

CÓDIGO	DESCRIPCIÓN	CANTIDAD
FILA 1		
90504	BL BISAGRA CAZOLETA SOBREPONER BC10 ZN	5
90491	BL BISAGRA CAZOLETA RECTA BC1 26mm ZN	5
90492	BL BISAGRA CAZOLETA ACOD BC1 26mm ZN	5
90493	BL BISAGRA CAZOLETA S-AC BC1 26mm ZN	5
90494	BL BISAGRA CAZOLETA RECTA BC2 35mm ZN	5
90495	BL BISAGRA CAZOLETA ACOD BC2 35mm ZN	5
90496	BL BISAGRA CAZOLETA S-AC BC2 35mm ZN	5
FILA 2		
90497	BL BISAGRA CAZOLETA CLIP RECTA BC3 35mm ZN	5
90498	BL BISAGRA CAZOLETA CLIP ACOD BC3 35mm ZN	5
90499	BL BISAGRA CAZOLETA CLIP S-AC BC3 35mm ZN	5
90501	BL BISAGRA CAZOLETA PISTON RECTA BC5 35mm ZN	5
90502	BL BISAGRA CAZOLETA PISTON ACOD BC5 35mm ZN	5
90503	BL BISAGRA CAZOLETA PISTON S-AC BC5 35mm ZN	5
91872	BL BISAGRA CAZOLETA 90° RINCONERA BC12 ZN	5
FILA 3		
90948	BL PERNIO S/R DCHA PN7 100x58mm IN	6
90949	BL PERNIO S/R IZDA PN7 100x58mm IN	6
90924	BL PERNIO C/R DCHA PN3 100x58mm LS	6
90925	BL PERNIO C/R IZDA PN3 100x58mm LS	6
90934	BL PERNIO S/R DCHA PN4 100x58mm NS	6
90935	BL PERNIO S/R IZDA PN4 100x58mm NS	6
90932	BL PERNIO S/R DCHA PN4 100x58mm LS	6
90933	BL PERNIO S/R IZDA PN4 100x58mm LS	6
90721	BL OVALILLO PERNIO OV1 LTD	6
90722	BL OVALILLO PERNIO OV1 NE	6
91885	BL OVALILLO PERNIO OV1 IN	6
91654	BL OVALILLO OV2 10x7x1,5mm LT	6
91655	BL OVALILLO OV2 12x8x1,5mm LT	6
91656	BL OVALILLO OV2 14x9x2mm LT	6
91657	BL OVALILLO OV2 16x11x2mm LT	6
91658	BL OVALILLO OV2 18x11x2mm LT	6
91659	BL OVALILLO OV2 20x12x2mm LT	6
91660	BL OVALILLO OV2 22x14x2,5mm LT	6
FILA 4		
91508	BL BISAGRA ALAS BS6 80x65mm NE	6
91509	BL BISAGRA ALAS BS7 75x45mm NE	6
91311	BL PERNIO PERFIL GOTA 695 10x60mm PU	6
91302	BL PERNIO TORNEADO 692 10x58mm PU	6
91303	BL PERNIO TORNEADO 692 12x70mm PU	6
91304	BL PERNIO TORNEADO 692 14x80mm PU	6
91305	BL PERNIO TORNEADO 692 16x100mm PU	6
91317	BL PERNIO PALA LARGA 699 14x80mm PU	6
91315	BL PERNIO PALA 696 14x80mm PU	6
91316	BL PERNIO PALA 696 16x100mm PU	5
91362	BL BISAGRA 840 4" BS31 100x70mm ZN	6

CÓDIGO	DESCRIPCIÓN	CANTIDAD
FILA 5		
91511	BL BISAGRA FORMA T BS8 75x75mm NE	6
91345	BL BISAGRA RAMAL 2" BS28 22x50mm ZN	6
91347	BL BISAGRA RAMAL 3" BS28 25x75mm ZN	6
91348	BL BISAGRA RAMAL 4" BS28 25x100mm ZN	6
91381	BL BISAGRA 5005 1" BS27 25x20mm LTD	6
91382	BL BISAGRA 5005 1"1/2 BS27 37x26mm LTD	6
91383	BL BISAGRA 5005 2" BS27 50x30mm LTD	6
91384	BL BISAGRA 5005 2"1/2 BS27 63x32mm LTD	6
91385	BL BISAGRA 5005 3" BS27 75x42mm LTD	6
90306	BL BISAGRA ESTUCHE BS22 13x20mm LP	6
90307	BL BISAGRA ESTUCHE BS22 13x25mm LP	6
90310	BL BISAGRA BS22+CIERRE EST. CC11 13x20+25mm LP	6
90945	BL BISAGRA SOLAPADA S/REM BS25 53mm LTD	6
90946	BL BISAGRA SOLAPADA S/REM BS25 53mm CB	6
90947	BL BISAGRA SOLAPADA S/REM BS25 53mm LE	6
33206	BISAGRA PIANO BS21 32x960mm NI	10
33203	BISAGRA PIANO BS21 32x960mm LTD	10
FILA 6		
57219	BL CIERRAPUERTAS C/RETENEDOR MC1-C PL	2
57218	BL CIERRAPUERTAS S/RETENEDOR MC1-S NE	2
57216	BL CIERRAPUERTAS S/RETENEDOR MC1-S PL	2
FILA 7		
57001	BL BISAGRA DOBLE ACCION BS10 BL	3
57004	BL BISAGRA DOBLE ACCION BS10 PL	3
57002	BL BISAGRA DOBLE ACCION BS10 NE	3
57201	BL MUELLE CIERRAPUERTAS BRAZO MC2 BL	3
57204	BL MUELLE CIERRAPUERTAS BRAZO MC2 PL	3
57202	BL MUELLE CIERRAPUERTAS BRAZO MC2 NE	3
FILA 8		
91685	BL COMPAS CABALLETE BCP10 216x15mm ZN	5
90119	BL PICAPORTE TUBULAR C/C PCT3 35mm LTD	5
90120	BL PICAPORTE TUBULAR C/C PCT3 35mm NS	5
90121	BL PICAPORTE TUBULAR C/C PCT3 45mm LTD	5
90122	BL PICAPORTE TUBULAR C/C PCT3 45mm NS	5
91578	BL PICAPORTE TUBULAR C/C PCT3 60mm LTD	5
91579	BL PICAPORTE TUBULAR C/C PCT3 60mm NS	5
FILA 9		
90637	BL PISTON GAS ELEVABLE BCP1 12kg AL	3
90601	BL BISAGRA COMPAS BCP5 200mm ZN	3
90842	BL PICAPORTE CONDENA C/R PCT1 47mm LTD	3
90843	BL PICAPORTE CONDENA C/R PCT1 47mm NS	3
91186	BL PICAPORTE CONDENA C/R PCT2 70mm LTD	3
91187	BL PICAPORTE CONDENA C/R PCT2 70mm NS	3

1 mt



BRIMIC

SOLUCIÓN BISAGRAS Y PICAPORTES

82 referencias
418 unidades

FILA 1



FILA 2



FILA 3



FILA 4



FILA 5



FILA 6



FILA 7



FILA 8



FILA 9



2 mts

SOLUCIONES BRIMIC



SOLUCIÓN COMPLEMENTOS ARMARIO Y MUEBLE

CÓDIGO	DESCRIPCIÓN	CANTIDAD
FILA 1		
91635	BL CANTO ADHESIVO CAN1 19x5mts BLANCO	5
91644	BL CANTO ADHESIVO CAN1 19x5mts ROBLE	5
91639	BL CANTO ADHESIVO CAN1 19x5mts HAYA	5
91642	BL CANTO ADHESIVO CAN1 19x5mts SAPELI	5
91606	BL CANTO MELAMINA CAN2 22x5mts BLANCO	5
91632	BL CANTO MELAMINA CAN2 22x5mts ROBLE	5
91610	BL CANTO MELAMINA CAN2 22x5mts HAYA	5
FILA 2		
90906	BL TAPON ADH TPN1 13mm BLANCO (20)	10
90912	BL TAPON ADH TPN1 13mm HAYA (20)	10
90913	BL TAPON ADH TPN1 13mm ROBLE (20)	10
90919	BL TAPON ADH TPN1 13mm WENGE (20)	10
90918	BL TAPON ADH TPN1 13mm SAPELI (20)	10
91828	BL TAPON ADH TPN1 13mm TEXTIL BEIGE (20)	10
91827	BL TAPON ADH TPN1 13mm TEXTIL CLARO (20)	10
90908	BL TAPON ADH TPN1 13mm NEGRO (20)	10
90910	BL TAPON ADH TPN1 13mm GRIS (20)	10
FILA 3		
91396	BL FIELTRO ADHESIVO DZ7 16mm BL	10
91389	BL FIELTRO ADHESIVO DZ7 16mm MA	10
91402	BL FIELTRO ADHESIVO DZ7 20mm BL	10
91395	BL FIELTRO ADHESIVO DZ7 20mm MA	10
91398	BL FIELTRO ADHESIVO DZ7 26mm BL	10
91391	BL FIELTRO ADHESIVO DZ7 26mm MA	10
91560	BL FIELTRO ADHESIVO DZ8 25x25mm BL	10
91555	BL FIELTRO ADHESIVO DZ8 25x25mm MA	10
91557	BL FIELTRO ADHESIVO DZ8 85x100mm MA	10
FILA 4		
90505	BL LAGRIMA ADHESIVA LGM1 7x1,5mm TR	10
91413	BL LAGRIMA ADHESIVA LGM1 8x2,2mm TR	10
91414	BL LAGRIMA ADHESIVA LGM1 10x1,5mm TR	10
90506	BL LAGRIMA ADHESIVA LGM1 10x3mm TR	10
91451	BL LAGRIMA ADHESIVA LGM3 16x7,9mm TR	10
90507	BL LAGRIMA ADHESIVA LGM2 13x4mm TR	10
91415	BL LAGRIMA ADHESIVA LGM4 20x6,2mm TR	10
91416	BL LAGRIMA ADHESIVA LGM5 10x10x2,5mm TR	10
91417	BL LAGRIMA ADHESIVA LGM6 12,5x12,5x5,8mm TR	10
FILA 5		
90204	BL TORNILLO MULTICORTE TRN7 M4x45mm BC	6
90207	BL TORNILLO DOWELL TRN9 M4x20mm ZN	6
90205	BL TORNILLO TRN10+TUERCA SILLA TRC8 3/16x50mm NI	6
90208	BL TORNILLO DOWELL TRN9 M6x70mm ZN	6
92116	BL TORNILLO CAMA TRN12 9x100mm BC	6
92113	BL TORNILLO CASCABEL TRN15 9x100mm BC	6
90556	BL TUERCA EMBUTIR TRC3 M6x12x12mm ZN	6
90558	BL TUERCA EMBUTIR TRC3 M8x13x16mm BC	6
90553	BL TUERCA PUA EMBUTIR TRC2 M6 ZN	6
90554	BL TUERCA PUA EMBUTIR TRC2 M8 ZN	6
91728	BL JGO TORNILLO UNION KOMBY TNE5 M4 NI	6
90322	BL JGO TORNILLO UNION KOMBY TNE4 M6 NI	6
90334	BL TORNILLO ENSAMBLE TNE8 34-40mm BL	6
90333	BL TORNILLO ENSAMBLE TNE8 26-32mm BL	6
90319	BL TORNILLO ENSAMBLE TNE1 5x50mm ZN	6
90320	BL TORNILLO ENSAMBLE TNE1 7x50mm ZN	6
90568	BL ENGANCHE EXCENTRICA 20+PERNO R/M EX4 NI	6
90561	BL EXCENTRICA 15+PERNO R/M EX6 ZN	6
FILA 6		
91230	BL EMPALME TUBO ARMARIO TA5 12mm ZN	6
91985	BL VARILLA HUECA VR1 M10/100x100mm+TUERCA TCR9 ZN	6
90375	BL DESLIZANTE CLAVO DZ1 17mm BL	6
90378	BL DESLIZANTE CLAVO DZ1 17mm MA	6
90373	BL TOPE 2 PUNTAS GRANDE TPM1 MA	6
90361	BL PORTAESTANTE SAFETY PE6 5mm TR	6
90362	BL PORTAESTANTE VITRINA GDE PE5 BL	6
90364	BL PORTAESTANTE VITRINA GDE PE5 MA	6
90363	BL PORTAESTANTE VITRINA PEQ PE5 BL	6

CÓDIGO	DESCRIPCIÓN	CANTIDAD
90365	BL PORTAESTANTE VITRINA PEQ PE5 MA	6
90352	BL PORTAESTANTE PE3 5x16mm LTD	6
90353	BL PORTAESTANTE PE3 5x16mm ZN	6
91724	BL OVALILLO ARANDELA OV3 14mm NI	6
91726	BL OVALILLO ARANDELA OV3 14mm LTD	6
90450	BL ANGULO C/TAPA PEQ AN20 18x20mm BL	6
90452	BL ANGULO C/TAPA PEQ AN20 18x20mm MA	6
91568	BL ANGULO TRASERA AN22 19x19mm NI	6
90582	BL GRAPA TRASERA RECTANGULAR GRP1 23x17mm ZN	6
FILA 7		
90604	BL LLAVERO PORTAETIQUETAS PTQ2 SURTIDO	6
91829	BL ANILLA P/LLAVE LLV3 SURTIDO	6
90611	BL LLAVERO ANILLA LLV1 16mm NI	6
90612	BL LLAVERO ANILLA LLV1 18mm NI	6
90613	BL LLAVERO ANILLA LLV1 20mm NI	6
90614	BL LLAVERO ANILLA LLV1 25mm NI	6
90615	BL LLAVERO ANILLA LLV1 30mm NI	6
90277	BL CIERRE TOCA-TOCA IM4 35x28mm BL	6
90272	BL CIERRE 2 RODILLOS GOMA IM1 ZN	6
90833	BL IMAN PIZARRA IM7 25mm SURTIDO	6
90281	BL CIERRE MAGNETICO IM2 42mm BL	6
90283	BL CIERRE MAGNETICO IM2 42mm MA	6
90536	BL EXPULSOR IMAN IM9 40mm C/BASE GR	6
90532	BL EXPULSOR C/BASE AMORTIGUADOR IM8 40mm GR	6
90290	BL CIERRE CAJA CC3 53x23mm ZN	6
90291	BL CIERRE CAJA CC1 75x23mm ZN	6
FILA 8		
90232	BL TAPON PASACABLES TPC1 60x22mm GR	6
90234	BL TAPON PASACABLES TPC1 60x22mm NE	6
90621	BL TAPON PASACABLES TPC1 60x22mm BL	6
90198	BL CUÑA NIVELADORA NV11 100x20x8mm MA	6
90341	BL ESPIGA DE MADERA ENS5 6x30mm	6
90342	BL ESPIGA DE MADERA ENS5 8x40mm	6
90343	BL ESPIGA DE MADERA ENS5 10x40mm	6
91195	BL TACHUELA PLANA TCH1 8x14mm LTD	6
91198	BL TACHUELA PLANA TCH1 10x15mm LTD	6
91226	BL CHINCHETA TCH2 NI	6
91225	BL CHINCHETA TCH2 SURTIDO	6
FILA 9		
90242	BL SOPORTE LATERAL OVAL STA6 NI	6
90249	BL SOPORTE LAT. STA6+CENTRAL OVAL STA7 25x15mm NI	6
90243	BL SOPORTE LATERAL OVAL STA6 LTD	6
90250	BL SOPORTE LAT. STA6+CENTRAL OVAL STA7 25x15mm LTD	6
90239	BL SOPORTE LATERAL STA1+CENTRAL STA2 19mm NI	6
90241	BL SOPORTE LATERAL STA1+CENTRAL STA2 12mm NI	6
90236	BL SOPORTE LATERAL STA1 19mm NI	6
90238	BL SOPORTE LATERAL STA1 12mm NI	6
90248	BL SOPORTE LATERAL OVAL STA15 17mm MA	6
90849	BL REMATE TUBO BELLOTA CT1 12mm CB	6
90848	BL ANILLA TUBO CT3 12mm CB	6
92123	BL CORCHETE CORTINA CT9 ZN	6
91388	BL CORCHETE CORTINA CT5 BL	6
92126	BL CORCHETE GUIA RIEL CT10 BL	6
FILA 10		
91228	BL ESPIRAL VISILLO FORRADO EV1 3mts BL	5
91648	BL RUEDA INFERIOR ARMARIO RUA5-H ZN	5
91647	BL RUEDA INFERIOR ARMARIO RUA5-M ZN	5
91550	BL POLEA PUERTA CORREDERA POL8 25mm LT	6
91099	BL CERRADURA VITRINA CM8 120mm CB	5
91095	BL CERRADURA MUEBLE CM1 26mm CB	6
91098	BL CERRADURA PULSAR CM3 26-35mm CB	6
91100	BL CERRADURA BUZON RECTA CM4 20mm CB	6
91102	BL CERRADURA BUZON CURVA CM5 20mm CB	6
BANDEJA INFERIOR		
94505	MARCO MICROONDAS MCR1 600x400mm BL	2
94508	MARCO MICROONDAS MCR1 600x400mm EI	2
94003	PANTALONERO 11 PERCHAS IA2 CB	2
94025	JGO ZAPATERO 2 BALDAS IA6 BL	2
94511	BL REJILLA FRIGO-HORNO 8 ELEM RJV1 BL	2
94512	BL REJILLA FRIGO-HORNO 8 ELEM RJV1 EI	2

1 mt



BRIMIC

SOLUCIÓN COMPLEMENTOS ARMARIO Y MUEBLE

126 referencias
829 unidades

FILA 1



91635 91644 91639 91642 91606 91632 91610

FILA 2



90906 90912 90913 90919 90918 91828 91827 90908 90910

FILA 3



91396 91389 91402 91395 91398 91391 91560 91555 91557

FILA 4



90505 91413 91414 90506 91451 90507 91415 91416 91417

FILA 5



90204 90207 90205 90208 92116 92113 90556 90558 90553 90554 91728 90322 90334 90333 90319 90320 90568 90561

FILA 6



91230 91985 90375 90378 90373 90361 90362 90364 90363 90365 90352 90353 91724 91726 90450 90452 91568 90582

FILA 7



90604 91829 90611 90612 90613 90614 90615 90277 90272 90833 90281 90283 90536 90532 90290 90291

FILA 8



90232 90234 90621 90198 90341 90342 90343 91195 91198 91226 91225

FILA 9



90242 90249 90243 90250 90239 90241 90236 90238 90248 90849 90848 92123 91388 92126

FILA 10



91228 91648 91647 91550 91099 91095 91098 91100 91102

2 mts

BANDEJA INFERIOR

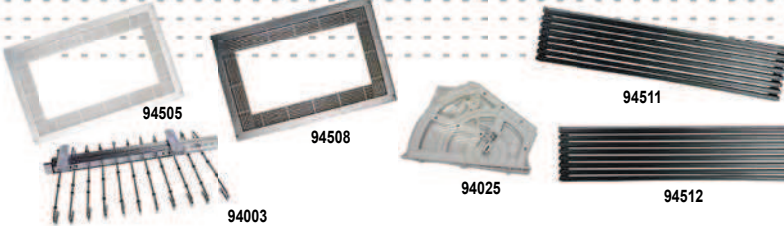

94505

94508

94025

94511

94512

94003

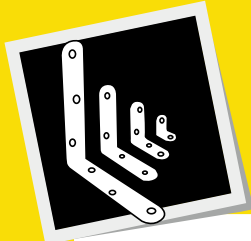

SOLUCIÓN ÁNGULOS Y COLGADORES

CÓDIGO	DESCRIPCIÓN	CANTIDAD
FILA 1		
91820	BL SOPORTE PELICANO SP8 42x53mm BL	6
91822	BL SOPORTE PELICANO SP8 42x53mm CM	6
90622	BL SOPORTE PELICANO SP4 75x65mm BL	5
90623	BL SOPORTE PELICANO SP4 75x65mm NE	5
90625	BL SOPORTE PELICANO SP4 75x65mm CB	5
90626	BL SOPORTE PELICANO SP4 75x65mm CM	5
90317	BL JGO BIVALENTE CG4+PLACA COLGAR CG2 BL	5
30513	BL JGO SOPORTE ESPEJOS SC7 45x25mm ZN	6
FILA 2		
90422	BL SOPORTE MEDIA LUNA SC6 5-6 mm BL	6
90420	BL SOPORTE MEDIA LUNA SC6 5-6mm CB	6
90431	BL SOPORTE MEDIA LUNA SC6 8-10mm BL	6
90429	BL SOPORTE MEDIA LUNA SC6 8-10mm CB	6
90385	BL EMBELLECEDOR LISO SC1 14mm NI	6
90386	BL EMBELLECEDOR LISO SC1 16mm NI	6
90381	BL EMBELLECEDOR LISO SC1 14mm LT	6
90382	BL EMBELLECEDOR LISO SC1 16mm LT	6
90393	BL EMBELLECEDOR FACETADO SC2 14mm NI	6
90394	BL EMBELLECEDOR FACETADO SC2 16mm NI	6
90389	BL EMBELLECEDOR FACETADO SC2 14mm LT	6
90390	BL EMBELLECEDOR FACETADO SC2 16mm LT	6
90398	BL SUJETALUNAS LISO SC3 2-6mm NI	6
90399	BL SUJETALUNAS LISO SC3 5-8mm NI	6
FILA 3		
90405	BL SOPORTE CILINDRICO SC4 5-6mm CB	6
90410	BL SOPORTE CILINDRICO SC4 8-10mm CB	6
90872	BL COLGADOR CUADROS PEQUEÑO CG16 BL	6
90873	BL COLGADOR CUADROS GRANDE CG17 BL	6
90457	BL GANCHO X N°1 CG13 LTD	6
90885	BL COLGADOR CUADROS TELA ENGOMADA CG18 BL	6
90460	BL COLGADOR CUADROS N°1 CG12 LTD	6
91886	BL COLGADOR CUADROS DENTADO CG19 LTD	6
90524	BL COLGADOR MUEBLE SENCILLO CG9 ZN	6
91121	BL COLGADOR MUEBLE EMBUTIR CG10 ZN	6
91242	BL PLACA COLGADOR EXTINTOR CG14 6kgs ZN	6
90315	BL JGO ESCUADRAS CG3+PLACA COLGAR CG2 ZN	6
90316	BL JGO GANCHO CG1+PLACA COLGADOR CG2 ZN	6
90838	BL COLGADOR ESCUADRA TRIANGULO CG7 ZN	6
FILA 4		
91140	BL ANGULO REFUERZO AN1 20x20x19mm BL	6
91141	BL ANGULO REFUERZO AN1 30x30x19mm BL	6
91142	BL ANGULO REFUERZO AN1 40x40x19mm BL	6
91143	BL ANGULO REFUERZO AN1 50x50x19mm BL	6
91144	BL ANGULO REFUERZO AN1 60x60x19mm BL	6
90444	BL ANGULO SUPER AN3 30x30mm BL	6
90446	BL ANGULO SUPER AN3 50x50mm BL	6
90445	BL ANGULO SUPER AN3 30x30mm NE	6
90447	BL ANGULO SUPER AN3 50x50mm NE	6
90526	BL PLACA COLGADOR GALERIA CG11 40x18mm ZN	6
90527	BL PLACA COLGADOR GALERIA CG11 50x18mm ZN	6
90528	BL PLACA COLGADOR GALERIA CG11 60x18mm ZN	6
FILA 5		
90433	BL ANGULO REFUERZO AN1 20x20x19mm BC	6
90434	BL ANGULO REFUERZO AN1 30x30x19mm BC	6
90435	BL ANGULO REFUERZO AN1 40x40x19mm BC	6
90436	BL ANGULO REFUERZO AN1 50x50x19mm BC	6
90437	BL ANGULO REFUERZO AN1 60x60x19mm BC	6
90439	BL ESCUADRA PLANA PLC4 30x30mm BC	6
90440	BL ESCUADRA PLANA PLC4 40x40mm BC	6
90441	BL ESCUADRA PLANA PLC4 50x50mm BC	6
90442	BL ESCUADRA PLANA PLC4 60x60mm BC	6
90516	BL PLACA RECTA UNION PLC1 40x16mm BC	6
90517	BL PLACA RECTA UNION PLC1 60x16mm BC	6
90518	BL PLACA RECTA UNION PLC1 80x19mm BC	6
90519	BL PLACA RECTA UNION PLC1 100x19mm BC	6
90523	BL PLACA RECTA UNION PLC2 100x15mm ZN	6

CÓDIGO	DESCRIPCIÓN	CANTIDAD
FILA 6		
91122	BL ANGULO REFUERZO AN2 20x20mm ZN	6
91123	BL ANGULO REFUERZO AN2 30x30mm ZN	6
91124	BL ANGULO REFUERZO AN2 40x40mm ZN	6
91125	BL ANGULO REFUERZO AN2 50x50mm ZN	6
91126	BL ANGULO REFUERZO AN2 60x60mm ZN	6
91128	BL ESCUADRA PLANA PLC5 40x40mm ZN	6
91129	BL ESCUADRA PLANA PLC5 50x50mm ZN	6
91130	BL ESCUADRA PLANA PLC5 60x60mm ZN	6
90844	BL PLACA CARTELA PLC3 30x13mm ZN	6
90845	BL PLACA CARTELA PLC3 40x15mm ZN	6
90846	BL PLACA CARTELA PLC3 50x17mm ZN	6
90847	BL PLACA CARTELA PLC3 60x20mm ZN	6
90522	BL PLACA RECTA UNION PLC2 80x15mm ZN	6
FILA 7		
92205	BL PLACA C/TUERCA PLC12 M8x50x50mm ZN	6
92206	BL PLACA C/TUERCA PLC12 M10x50x50mm ZN	6
91139	BL ANGULO FIJACION AN10 38x28x23 ZN	6
91132	BL PLACA CUADRADA PLC6 45x45mm ZN	6
91133	BL PLACA RECTANGULAR PLC7 70x35 ZN	6
91134	BL ANGULO REFUERZO AN5 20x20x40mm ZN	6
91135	BL ANGULO REFUERZO AN6 20x20x50mm ZN	6
91136	BL ANGULO REFUERZO AN7 21x21x67mm ZN	6
91137	BL ANGULO REFUERZO AN8 21x21x86mm ZN	6
FILA 8		
92131	BL ANILLA C/PLACA TOLDOS AP3 ZN	6
91243	BL HEMBRILLA C/T SOLDADA HM1 M3x30mm ZN	6
91244	BL HEMBRILLA C/T SOLDADA HM1 M4x30mm ZN	6
91245	BL HEMBRILLA C/T SOLDADA HM1 M5x40mm ZN	6
91246	BL HEMBRILLA C/T SOLDADA HM1 M6x50mm ZN	6
91247	BL HEMBRILLA C/T SOLDADA HM1 M8x60mm ZN	6
91249	BL HEMBRILLA C/T ABIERTA HM2 M4x30mm ZN	6
91250	BL HEMBRILLA C/T ABIERTA HM2 M5x35mm ZN	6
91251	BL HEMBRILLA C/T ABIERTA HM2 M6x50mm ZN	6
91252	BL HEMBRILLA C/T ABIERTA HM2 M8x60mm ZN	6
90465	BL GANCHO FORMA S CG23 30mm ZN	6
90467	BL GANCHO FORMA S CG23 40mm ZN	6
90468	BL GANCHO FORMA S CG23 50mm ZN	6
90469	BL GANCHO FORMA S CG23 60mm ZN	6
90470	BL GANCHO FORMA S CG23 70mm ZN	6
90471	BL GANCHO FORMA S CG23 80mm ZN	6
FILA 9		
90512	BL ASA ABATIBLE LISA TRM12 100x27mm ZN	5
90514	BL ASA ABATIBLE LISA TRM12 100x27mm BC	5
90510	BL ASA ABATIBLE LISA TRM12 100x27mm NE	5
92139	BL ANILLA SOLDADA C/HEMRILLA AP4 ZN	5
92140	BL ANILLA SOLDADA C/PLACA AP6 ZN	5
92141	BL GANCHO C/PLACA FIJO AP7 ZN	5
92142	BL GANCHO C/PLACA MOVIL AP5 ZN	5
91138	BL ANGULO REFUERZO AN9 40x40x90mm ZN	5
BANDEJA INFERIOR		
39134	PLACA PESANTE PLC9 80x50mm ZN	50
39135	PLACA PESANTE PLC9 120x50mm ZN	50
39136	PLACA PESANTE PLC9 160x50mm ZN	25
39137	PLACA PESANTE PLC9 200x50mm ZN	25
39149	ANGULO PESANTE AN12 40x40x20mm ZN	100
39150	ANGULO PESANTE AN12 40x40x40mm ZN	50
39151	ANGULO PESANTE AN12 50x50x40mm ZN	50
39152	ANGULO PESANTE AN14 60x60x40mm ZN	50
39138	ANGULO PESANTE AN13 40x40x50mm ZN	50
39139	ANGULO PESANTE AN13 60x60x50mm ZN	50
39140	ANGULO PESANTE AN13 80x80x50mm ZN	25
39141	ANGULO PESANTE AN13 100x100x50mm ZN	25
39142	ANGULO PESANTE AN15 60x60x50mm ZN	50
39143	ANGULO PESANTE AN16 85x85x65mm ZN	25
39144	ANGULO PESANTE AN17 100x100x90mm ZN	20
80044	SOPORTE HAMACA ABIERTO AP1 ZN	2
80046	SOPORTE HAMACA CERRADO AP2 ZN	2
39175	SOPORTE VIGA INCLINADO SV1 70x70x80mm ZN	4

1 mt



BRIMIC

SOLUCIÓN ÁNGULOS Y COLGADORES

126 referencias
1.288 unidades

FILA 1



FILA 2



FILA 3



FILA 4



FILA 5



FILA 6



FILA 7



FILA 8



FILA 9



2 mts

BANDEJA INFERIOR

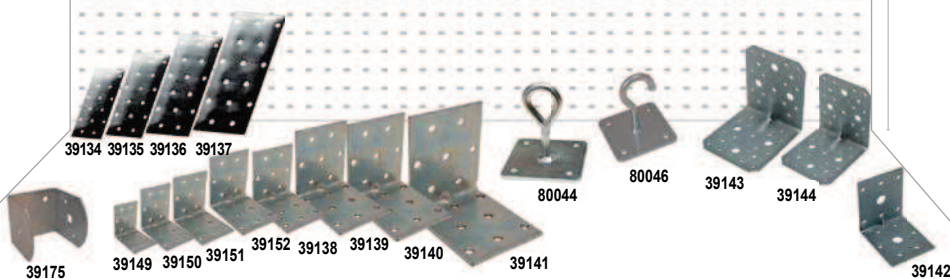

SOLUCIONES BRIMIC

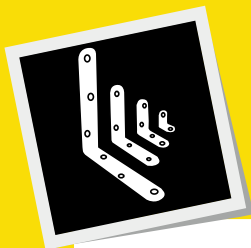

SOLUCIÓN BANDEJA ÁNGULOS

SOLUCIONES BRIMIC

CÓDIGO	DESCRIPCIÓN	CANTIDAD
FILA 1		
91140	BL ANGULO REFUERZO AN1 20x20x19mm BL	6
91141	BL ANGULO REFUERZO AN1 30x30X19mm BL	6
91142	BL ANGULO REFUERZO AN1 40x40X19mm BL	6
91143	BL ANGULO REFUERZO AN1 50x50X19mm BL	6
91144	BL ANGULO REFUERZO AN1 60x60X19mm BL	6
90444	BL ANGULO SUPER AN3 30x30mm BL	6
90446	BL ANGULO SUPER AN3 50x50mm BL	6
90445	BL ANGULO SUPER AN3 30x30mm NE	6
90447	BL ANGULO SUPER AN3 50x50mm NE	6
91139	BL ANGULO FIJACION AN10 38x28x23 ZN	6
FILA 2		
90433	BL ANGULO REFUERZO AN1 20x20x19mm BC	6
90434	BL ANGULO REFUERZO AN1 30x30X19mm BC	6
90435	BL ANGULO REFUERZO AN1 40x40X19mm BC	6
90436	BL ANGULO REFUERZO AN1 50x50X19mm BC	6
90437	BL ANGULO REFUERZO AN1 60x60X19mm BC	6
91122	BL ANGULO REFUERZO AN2 20x20mm ZN	6
91123	BL ANGULO REFUERZO AN2 30x30mm ZN	6
91124	BL ANGULO REFUERZO AN2 40x40mm ZN	6
91125	BL ANGULO REFUERZO AN2 50x50mm ZN	6
91126	BL ANGULO REFUERZO AN2 60x60mm ZN	6
90838	BL COLGADOR ESCUADRA TRIANGULO CG7 ZN	6
FILA 3		
90439	BL ESCUADRA PLANA PLC4 30x30mm BC	6
90440	BL ESCUADRA PLANA PLC4 40x40mm BC	6
90441	BL ESCUADRA PLANA PLC4 50x50mm BC	6
90442	BL ESCUADRA PLANA PLC4 60x60mm BC	6
91128	BL ESCUADRA PLANA PLC5 40x40mm ZN	6
91129	BL ESCUADRA PLANA PLC5 50x50mm ZN	6
91130	BL ESCUADRA PLANA PLC5 60x60mm ZN	6
90526	BL PLACA COLGADOR GALERIA CG11 40x18mm ZN	6
90527	BL PLACA COLGADOR GALERIA CG11 50x18mm ZN	6
90528	BL PLACA COLGADOR GALERIA CG11 60x18mm ZN	6
92131	BL ANILLA C/PLACA TOLDOS AP3 ZN	6
FILA 4		
90516	BL PLACA RECTA UNION PLC1 40x16mm BC	6
90517	BL PLACA RECTA UNION PLC1 60x16mm BC	6
90518	BL PLACA RECTA UNION PLC1 80x19mm BC	6
90519	BL PLACA RECTA UNION PLC1 100x19mm BC	6
90520	BL PLACA RECTA UNION PLC2 40x15mm ZN	6
90521	BL PLACA RECTA UNION PLC2 60x15mm ZN	6
90522	BL PLACA RECTA UNION PLC2 80x15mm ZN	6
90523	BL PLACA RECTA UNION PLC2 100x15mm ZN	6
90844	BL PLACA CARTELA PLC3 30x13mm ZN	6
90845	BL PLACA CARTELA PLC3 40x15mm ZN	6
90846	BL PLACA CARTELA PLC3 50x17mm ZN	6
90847	BL PLACA CARTELA PLC3 60x20mm ZN	6
FILA 5		
92205	BL PLACA C/TUERCA PLC12 M8x50x50mm ZN	6
92206	BL PLACA C/TUERCA PLC12 M10x50x50mm ZN	6
91132	BL PLACA CUADRADA PLC6 45x45mm ZN	6
91133	BL PLACA RECTANGULAR PLC7 70x35 ZN	6
91134	BL ANGULO REFUERZO AN5 20x20x40mm ZN	6
91135	BL ANGULO REFUERZO AN6 20x20x50mm ZN	6
91136	BL ANGULO REFUERZO AN7 21x21x67mm ZN	6
91137	BL ANGULO REFUERZO AN8 21x21x86mm ZN	6
91138	BL ANGULO REFUERZO AN9 40x40x90mm ZN	5

CÓDIGO	DESCRIPCIÓN	CANTIDAD
BANDEJA 1		
39133	ANGULO ANCLAJE C/TORNILLO AN19 30x36mm ZN	50
39121	ANGULO REFUERZO AN4 20x20x30mm ZN	50
39122	ANGULO REFUERZO AN4 30x30x30mm ZN	50
39123	ANGULO REFUERZO AN4 40x40x30mm ZN	50
39124	ANGULO REFUERZO AN4 50x50x30mm ZN	50
39125	ANGULO REFUERZO AN4 60x60x30mm ZN	50
39149	ANGULO PESANTE AN12 40x40x20mm ZN	100
39150	ANGULO PESANTE AN12 40x40x40mm ZN	50
39151	ANGULO PESANTE AN12 50x50x40mm ZN	50
BANDEJA 2		
91005	ET ANGULO REFUERZO AN1 80x80X19mm BC	100
91006	ET ANGULO REFUERZO AN1 100x100X19mm BC	50
39138	ANGULO PESANTE AN13 40x40x50mm ZN	50
39139	ANGULO PESANTE AN13 60x60x50mm ZN	50
39140	ANGULO PESANTE AN13 80x80x50mm ZN	25
39141	ANGULO PESANTE AN13 100x100x50mm ZN	25
39152	ANGULO PESANTE AN14 60x60x40mm ZN	50
39153	ANGULO PESANTE AN14 60x60x60mm ZN	50
39154	ANGULO PESANTE AN14 60x60x80mm ZN	25
BANDEJA 3		
39155	ANGULO PESANTE AN14 80x80x80mm ZN	25
39142	ANGULO PESANTE AN15 60x60x50mm ZN	50
39143	ANGULO PESANTE AN16 85x85x65mm ZN	25
39144	ANGULO PESANTE AN17 100x100x90mm ZN	20
39145	ANGULO PESANTE 135° AN18 80x80x50mm ZN	25
39126	PLACA RECTA UNION PLC8 40x30mm ZN	50
39127	PLACA RECTA UNION PLC8 60x30mm ZN	50
39128	PLACA RECTA UNION PLC8 80x30mm ZN	50
39129	PLACA RECTA UNION PLC8 100x30mm ZN	50
BANDEJA 4		
39130	PLACA RECTA UNION PLC8 120x30mm ZN	50
39134	PLACA PESANTE PLC9 80x50mm ZN	50
39135	PLACA PESANTE PLC9 120x50mm ZN	50
39136	PLACA PESANTE PLC9 160x50mm ZN	25
39137	PLACA PESANTE PLC9 200x50mm ZN	25
39156	PLACA RECTA PERFORADA PLC10 160x40mm ZN	50
39157	PLACA RECTA PERFORADA PLC10 200x60mm ZN	25
39158	PLACA RECTA PERFORADA PLC10 240x80mm ZN	25
39146	PLACA FORMA T PLC11 160x45x100mm ZN	20

1 mt



BRIMIC

SOLUCIÓN BANDEJA ÁNGULOS

89 referencias
1.907 unidades

FILA 1



FILA 2



FILA 3



FILA 4



FILA 5



2 mts

BANDEJA 1



BANDEJA 2



BANDEJA 3



BANDEJA 4



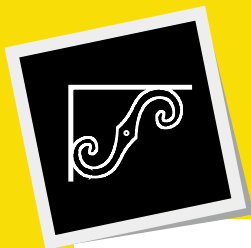

SOLUCIÓN PALOMILLAS

CÓDIGO	DESCRIPCIÓN	CANTIDAD
FILA 1		
80100	PALOMILLA CLASICA PLM1 100x75mm BL	20
80125	PALOMILLA CLASICA PLM1 125x100mm BL	20
80150	PALOMILLA CLASICA PLM1 150x125mm BL	20
80175	PALOMILLA CLASICA PLM1 175x150mm BL	20
80200	PALOMILLA CLASICA PLM1 200x150mm BL	20
80250	PALOMILLA CLASICA PLM1 250x200mm BL	20
80300	PALOMILLA CLASICA PLM1 300x250mm BL	20
80350	PALOMILLA CLASICA PLM1 350x300mm BL	20
80400	PALOMILLA CLASICA PLM1 400x350mm BL	20
35101	PALOMILLA SUPER PLM3 125x125mm BL	25
35102	PALOMILLA SUPER PLM3 150x125mm BL	25
35103	PALOMILLA SUPER PLM3 200x150mm BL	20
35104	PALOMILLA SUPER PLM3 250x200mm BL	10
35105	PALOMILLA SUPER PLM3 300x250mm BL	10
35106	PALOMILLA SUPER PLM3 350x250mm BL	6
FILA 2		
37530	PALOMILLA REFORZADA PLM4 300x220mm BL	10
37540	PALOMILLA REFORZADA PLM4 400x280mm BL	10
37550	PALOMILLA REFORZADA PLM4 500x350mm BL	10
37630	PALOMILLA REFORZADA PLM4 300x220mm GR	10
37640	PALOMILLA REFORZADA PLM4 400x280mm GR	10
37650	PALOMILLA REFORZADA PLM4 500x350mm GR	10

CÓDIGO	DESCRIPCIÓN	CANTIDAD
FILA 3		
37330	PALOMILLA 3 POSICIONES PLM6 300x300mm BL	10
37340	PALOMILLA 3 POSICIONES PLM6 400x400mm BL	6
37430	PALOMILLA 3 POSICIONES PLM6 300x300mm CB	10
37440	PALOMILLA 3 POSICIONES PLM6 400x400mm CB	6
33010	PALOMILLA ORNAMENTAL PLM5 100x90mm NE	10
33015	PALOMILLA ORNAMENTAL PLM5 150x115mm NE	10
33020	PALOMILLA ORNAMENTAL PLM5 200x150mm NE	10
33025	PALOMILLA ORNAMENTAL PLM5 250x190mm NE	10
BANDEJA INFERIOR		
31277	SOPORTE TV LCD STV1 17"-37" NE	1
31278	SOPORTE TV LCD STV2 17"-37" NE	1
31279	SOPORTE TV LCD STV3 17"-37" NE	1
31280	SOPORTE TV LCD STV4 17"-47" NE	1
80451	SOPORTE MICROONDAS MCR2 40kgs BL	1

1 mt



BRIMIC

SOLUCIÓN PALOMILLAS

34 referencias
413 unidades

FILA 1

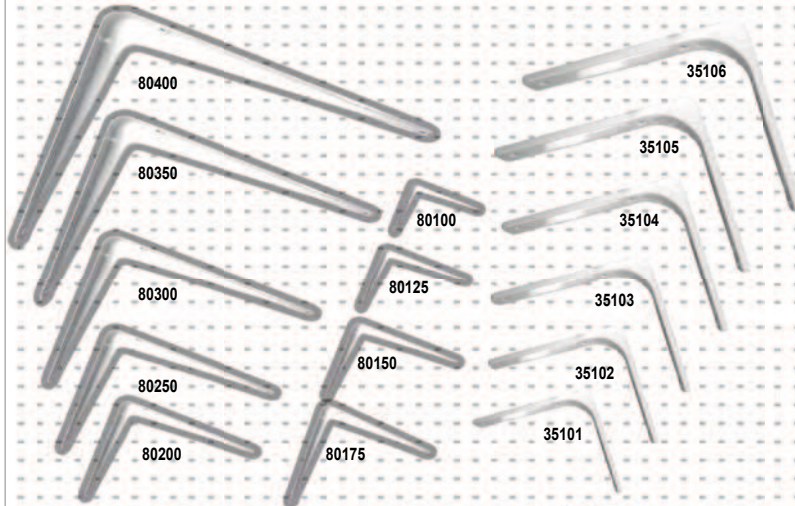

FILA 2

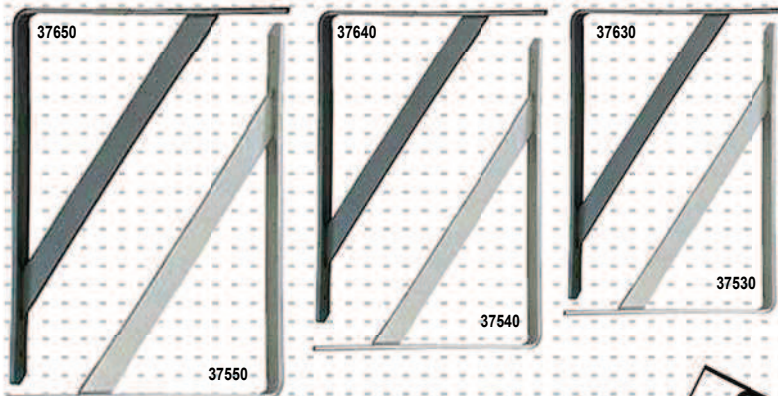

2 mts

FILA 3

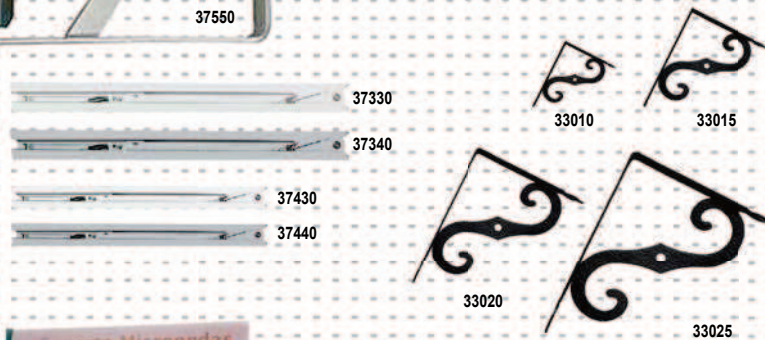

80451

BANDEJA INFERIOR



31277



31278



31279



31280



SOLUCIÓN PATAS

CÓDIGO	DESCRIPCIÓN	CANTIDAD
FILA 1		
96154	BL NIVELADOR PATA ECO NV9 M10x29mm CB	5
91491	BL RUEDA NIDO CIRCULAR RUM12 50mm GR	6
91490	BL RUEDA NIDO EMBUTIR RUM11 50mm GR	6
91489	BL RUEDA NIDO LATERAL RUM10 35mm ZN	6
91150	BL RUEDA MUEBLE FIJA RUM9 30mm ZN	6
91149	BL RUEDA MUEBLE FIJA RUM9 25mm ZN	6
91148	BL RUEDA MUEBLE FIJA RUM9 15mm ZN	6
92203	BL RUEDA EMBUTIR RUM1 22mm NE	6
91146	BL RUEDA EMBUTIR GIRATORIA RUM7 40mm NE	6
91147	BL RUEDA EMBUTIR FIJA RUM8 40mm NE	6
FILA 2		
96154	BL NIVELADOR PATA ECO NV9 M10x29mm CB	5
90850	BL CONTERA CUAD ALETAS CNT3 20X20mm NE	6
90852	BL CONTERA CUAD ALETAS CNT3 30X30mm NE	6
90856	BL CONTERA RECT ALETAS CNT4 20x40mm NE	6
90855	BL CONTERA RECT ALETAS CNT4 15X30mm NE	6
90859	BL CONTERA RED ALETAS CNT2 20mm NE	6
90860	BL CONTERA RED ALETAS CNT2 22mm NE	6
90861	BL CONTERA RED ALETAS CNT2 25mm NE	6
90862	BL CONTERA RED ALETAS CNT2 30mm NE	6
FILA 3		
96130	PATA ECO CUADRADA PT24 100x25mm BL	4
96136	PATA ECO CUADRADA PT24 100x25mm GR	4
96142	PATA ECO CUADRADA PT24 100x25mm NE	4
96106	PATA ECO REDONDA PT23 100x30mm BL	4
96112	PATA ECO REDONDA PT23 100x30mm GR	4
96118	PATA ECO REDONDA PT23 100x30mm NE	4
96203	PATA MUEBLE REDONDA PT14 80-110mm AL	4
92133	BL CONTERA RED CAUCHO CNT8 16-17mm NE	6
92134	BL CONTERA RED CAUCHO CNT8 18-19mm NE	6
92135	BL CONTERA RED CAUCHO CNT8 20-21mm NE	6
91925	BL CONTERA RED FLEXIBLE CNT7 22mm NE	6
FILA 4		
96131	PATA ECO CUADRADA PT24 150x25mm BL	4
96137	PATA ECO CUADRADA PT24 150x25mm GR	4
96143	PATA ECO CUADRADA PT24 150x25mm NE	4
96107	PATA ECO REDONDA PT23 150x30mm BL	4
96113	PATA ECO REDONDA PT23 150x30mm GR	4
96119	PATA ECO REDONDA PT23 150x30mm NE	4
96204	PATA MUEBLE REDONDA PT14 100-130mm AL	4
92136	BL CONTERA RED CAUCHO CNT8 25-26mm NE	5
91928	BL CONTERA RED FLEXIBLE CNT7 30mm NE	5
91931	BL CONTERA P/MULETAS CNT9 18-19mm NE	5

CÓDIGO	DESCRIPCIÓN	CANTIDAD
FILA 5		
96133	PATA ECO CUADRADA PT24 400x25mm BL	4
96139	PATA ECO CUADRADA PT24 400x25mm GR	4
96145	PATA ECO CUADRADA PT24 400x25mm NE	4
96109	PATA ECO REDONDA PT23 400x30mm BL	4
96115	PATA ECO REDONDA PT23 400x30mm GR	4
96121	PATA ECO REDONDA PT23 400x30mm NE	4
96205	PATA MUEBLE REDONDA PT14 120-150mm AL	4
91735	BL NIVELADOR REGULABLE NV3 M6x17mm NE	6
90551	BL NIVELADOR POMO NV8 M10x40mm NE	6
90549	BL NIVELADOR POMO NV8 M6x27mm NE	6
90550	BL NIVELADOR POMO NV8 M8x38mm NE	6
91731	BL NIVELADOR PLANO NV5 M6x32mm NE	6
91732	BL NIVELADOR PLANO NV5 M8x38mm NE	6
96206	PATA MUEBLE REDONDA PT14 150-170mm AL	4
91738	BL PLACA TRIANGULO C/ROSCA PLC13 M10 ZN	5
91733	BL NIVELADOR PLANO NV6 M8x38mm NE	5
91734	BL NIVELADOR PLANO NV6 M10x47mm NE	5
FILA 6		
96134	PATA ECO CUADRADA PT24 700x25mm BL	4
96140	PATA ECO CUADRADA PT24 700x25mm GR	4
96146	PATA ECO CUADRADA PT24 700x25mm NE	4
96110	PATA ECO REDONDA PT23 700x30mm BL	4
96116	PATA ECO REDONDA PT23 700x30mm GR	4
96122	PATA ECO REDONDA PT23 700x30mm NE	4
96208	PATA MUEBLE CUADRADA PT15 80x40mm AL	4
96209	PATA MUEBLE CUADRADA PT15 100x40mm AL	4
90474	BL PINZA ZOCALO MADERA/ALUMINIO ZCL5 NE	6
91599	BL PINZA ZOCALO PVC/ALUMINIO ZCL6 NE	6
96001	PATA MESA PT6 710x60mm BL	4
96002	PATA MESA PT6 710x60mm NE	4
96004	PATA MESA PT6 710x60mm NS	4
BANDEJA INFERIOR		
96400	JGO 4 PATAS SOMIER PT25 250x30x30mm S/R NE	2
96401	JGO 4 PATAS SOMIER PT25 250x30x30mm C/R NE	2
96404	JGO 4 PATAS SOMIER PT25 250x30x40mm S/R NE	2
96405	JGO 4 PATAS SOMIER PT25 250x30x40mm C/R NE	2
96406	JGO 4 PATAS CANAPE PT26 270x50mm S/R NE	2
96413	JGO 4 PATAS CANAPE PT26 270x50mm S/R GR	2
96301	PATA MUEBLE REDONDA PT11 130-200mm NE	16
96302	PATA MUEBLE REDONDA T/PLAST PT12 130-200mm NE	16
96303	PATA MUEBLE REDONDA T/ZAMAK PT12 130-200mm NE	16

1 mt



BRIMIC

SOLUCIÓN PATAS

79 referencias
406 unidades

FILA 1



96154 91491 91490 91489 91150 91149 91148 92203 91146 91147

FILA 2



96154 90850 90852 90856 90855 90859 90860 90861 90862

FILA 3



96130 96136 96142 96106 96112 96118 96203 92133 92134 92135 91925

FILA 4



96131 96137 96143 96107 96113 96119 96204 92136 91928 91931

FILA 5



96133 96139 96145 96109 96115 96121 96205 91735 90551 90549 90550 91731 91732

FILA 6

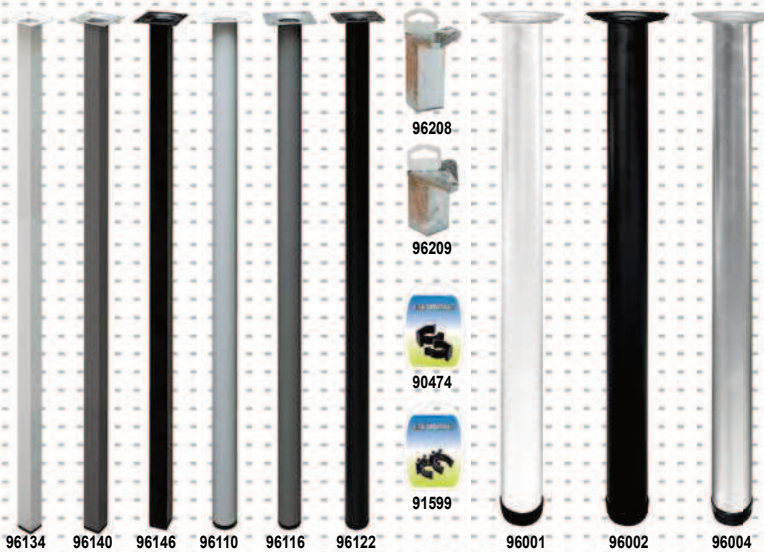

96134 96140 96146 96110 96116 96122 96206 91738 91733 91734 96208 96209 90474 91599 96001 96002 96004

2 mts

BANDEJA INFERIOR



96301



96400-96401-96404-96405



96406-96413



96302-96303



SOLUCIÓN HERRAJES DE PERSIANA

CÓDIGO	DESCRIPCIÓN	CANTIDAD
FILA 1		
91749	BL RECOGEDOR ABATIBLE PR2 14mm BL	3
91752	BL RECOGEDOR ABATIBLE PR2 14mm MF	3
91743	BL RECOGEDOR EMBUTIR PR1 14mm BL	3
91745	BL RECOGEDOR EMBUTIR PR1 14mm MA	3
91759	BL RECOGEDOR METALICO PR5 ZN	3
FILA 2		
91753	BL RECOGEDOR ABATIBLE PR2 18mm BL	3
91756	BL RECOGEDOR ABATIBLE PR2 18mm MF	3
91746	BL RECOGEDOR EMBUTIR PR1 18mm BL	3
91748	BL RECOGEDOR EMBUTIR PR1 18mm MA	3
91758	BL RECOGEDOR PLASTICO GRANDE PR4 BL	3
FILA 3		
91774	BL TOPE PERSIANA PR8 40mm BL	6
91775	BL TOPE PERSIANA PR8 40mm GR	6
91776	BL TOPE PERSIANA PR8 40mm MA	6
91777	BL TOPE PERSIANA PR8 40mm MF	6
91778	BL TOPE PERSIANA PR8 60mm BL	6
91779	BL TOPE PERSIANA PR8 60mm GR	6
91780	BL TOPE PERSIANA PR8 60mm MA	6
91781	BL TOPE PERSIANA PR8 60mm MF	6
92151	BL TIRANTE C/FLEJE PR18 GR	4
91757	BL RECOGEDOR PLASTICO PEQUEÑO PR4 BL	3
FILA 4		
91769	BL CARCASA GUIA CINTA PR12 BL	6
91767	BL GUIA CINTA PERSIANA METALICA PR11 BL	6
91768	BL GUIA CINTA PERSIANA METALICA PR11 AL	6
91766	BL GUIA CINTA PERSIANA PLASTICO PR10 BL	6
91771	BL SOPORTE PINCHO PR14 ZN	6
91772	BL SOPORTE RODILLOS PR13 ZN	6
91773	BL SOPORTE PR15+RODAMIENTO PR16 28mm ZN	6

CÓDIGO	DESCRIPCIÓN	CANTIDAD
FILA 5		
91786	BL CINTA PERSIANA PR26 14x6mts BL/PINTAS	5
91790	BL CINTA PERSIANA PR26 18x6mts BL/PINTAS	5
91794	BL CINTA PERSIANA PR26 22x6mts GR/BL	5
91784	BL CINTA PERSIANA PR26 14x6mts MA	5
92173	BL CUERDA P/TORNO PERSIANA PR17 6mts BL	6
92152	BL SEGURO PERSIANA PASADOR PR22 6x80mm BC	6
91575	BL SEGURO PERSIANA PR9 120mm BL	4
91577	BL SEGURO PERSIANA PR9 120mm CB	4
91576	BL SEGURO PERSIANA PR9 120mm NE	4
FILA 6		
91783	BL CINTA PERSIANA PR26 14x6mts GR	6
91785	BL CINTA PERSIANA PR26 14x6mts BE	6
91791	BL CINTA PERSIANA PR26 18x6mts GR	6
91792	BL CINTA PERSIANA PR26 18x6mts BE	6
91795	BL CINTA PERSIANA PR26 22x6mts BE/BL	6
92138	BL JGO ENGANCHE MOSQUITERA MQ1 NE	6
92137	BL JGO ENGANCHE MOSQUITERA MQ1 BL	6
91891	BL RODAMIENTO MOSQUITERA RD5 21mm NE	6
91892	BL RODAMIENTO MOSQUITERA RD5 23mm NE	6
FILA 7		
91156	BL POLEA TENDER C/TUERCA POL1 40mm ZN	5
91154	BL POLEA TENDER C/TUERCA POL2 40mm ZN	5
91153	BL POLEA TENDER TORNILLO POL3 40mm ZN	5
92186	BL KIT MOSQUITERA CORREDERA PEQ MQ2 BL	4
92187	BL KIT MOSQUITERA CORREDERA PEQ MQ2 NE	4
92184	BL KIT MOSQUITERA CORREDERA GDE MQ2 BL	4
92185	BL KIT MOSQUITERA CORREDERA GDE MQ2 NE	4
BANDEJA INFERIOR		
90073	MECANISMO TORNO PERSIANA EMPOTRAR PR17	2
90075	POLEA METALICA PR19 180mm ZN	3
90076	CONTERA METALICA PR20 57mm ZN	3
90078	POLEA PLASTICO ESPIGA CINTA 18mm PR21 NE	3
90077	POLEA PLASTICO P/RODAMIENTO CINTA 18mm PR21 NE	3

1 mt



BRIMIC

SOLUCIÓN HERRAJES DE PERSIANA

57 referencias
270 unidades

FILA 1



91749 91752 91743 91745 91759

FILA 2



91753 91756 91746 91748 91758

FILA 3



91774 91775 91776 91777 91778 91779 91780 91781

FILA 4



91769 91767 91768 91766 91771 91772 91773 92151 91757

FILA 5



91786 91790 91794 91784 92173 92152 91575 91577 91576

FILA 6



91783 91785 91791 91792 91795 92138 92137 91891 91892

FILA 7



91156 91154 91153 92186 92187 92184 92185

2 mts

BANDEJA INFERIOR



90073 90075 90076 90078 90077

SOLUCIONES BRIMIC

BRIMIC

Los expositores de este catálogo tienen unas dimensiones de 2x1 mts.

¡CONSULTA OTRAS MEDIDAS!





ALFABÉTICO

Descripción	Familia	Pág.	Descripción	Familia	Pág.	Descripción	Familia	Pág.
ABRAZADERA RECTANGULAR VN14	11	353	BISAGRA FORMA T BS23	5	190	CERRADURA VITRINA CM7	8	244
ABRAZADERA REDONDA VN13	11	353	BISAGRA FORMA T BS8	5	191	CERRADURA VITRINA CM8	8	244
ACCESORIOS MADERA PCR8	3	149	BISAGRA LIBRO 697	5	181	CERROJO SEGURIDAD CRR1	3	113
ADAPTADOR UNIFICADO CS8	3	112	BISAGRA MAMPARA 135° BSC6	4	161	CERROJO SEGURIDAD CRR2	3	113
ALDABA BARCO ADB2	3	132	BISAGRA MAMPARA 180° BSC7	4	161	CHINCHETA TCH2	15	415
ALDABA CLASICA ADB1	3	131	BISAGRA MAMPARA 90° BSC3	4	160	CIERRAPUERTAS MC1	5	173
ALDABA CUÑA ADB7	3	132	BISAGRA MAMPARA 90° BSC4	4	160	CIERRE 2 RODILLOS IM1	8	248
ALDABA FORJA ADB4	3	131	BISAGRA MAMPARA 90° BSC5	4	160	CIERRE ARCON CC8	3	135
ALDABA FORJA ADB5	3	131	BISAGRA MAMPARA FIJA BSC2	4	160	CIERRE ARCON CC9	3	135
ALDABA REVERSIBLE ADB6	3	130	BISAGRA MOSTRADOR BS19	5	184	CIERRE BOLAIM6	8	248
ALDABILLA RETENIDA ADB3	3	132	BISAGRA MUEBLE BS5	5	184	CIERRE CAJA C/LAVE CC7	8	291
ALFILER VISILLO CT13	8	238	BISAGRA OCULTA BS1	5	183	CIERRE CAJA CC1	8	290
ALZAPAÑO TORNEADO PER19	10	333	BISAGRA OCULTA BS2	5	183	CIERRE CAJA CC2	8	290
AMORTIGUADOR EMBUTIR IM13	8	250	BISAGRA OCULTA BS3	5	183	CIERRE CAJA CC3	8	291
AMORTIGUADOR GUIA GC15	7	212	BISAGRA OCULTA BS4	5	183	CIERRE CAJA CC4	8	291
AMORTIGUADORES AC2	9	303	BISAGRA PARED-CRISTAL BSC1	4	159	CIERRE CAJA CC5	8	291
ANCLAJE PRECERCO PRC1	3	118	BISAGRA PIANO BS21	5	190	CIERRE CAJA REGULABLE CC6	8	291
ANGULO ANCLAJE AN19	9	317	BISAGRA PIANO BS32	5	190	CIERRE CONTRAVENTANA 6840	2	57
ANGULO CONECTOR BSC20	4	162	BISAGRA PIVOTANTE BS13	5	182	CIERRE CORREDERA 6820	2	62
ANGULO CONECTOR CB27	4	155	BISAGRA PIVOTANTE BS14	5	182	CIERRE CORREDERA 6821	2	63
ANGULO FLUJACION AN10	9	309	BISAGRA PIVOTANTE BS9	5	182	CIERRE CORREDERA 6822	2	63
ANGULO FLUJACION AN11	9	310	BISAGRA PLANA CB2	4	153	CIERRE CORREDERA 6823	2	63
ANGULO MAMPARA 135° BSC19	4	162	BISAGRA PLANA CB26	4	153	CIERRE CORREDERA 6826	2	64
ANGULO MAMPARA 180° BSC18	4	162	BISAGRA PLANA CB3	4	153	CIERRE CORREDERA 6836	2	64
ANGULO MAMPARA 90° BSC16	4	161	BISAGRA RAMAL BS28	5	187	CIERRE CORREDERA 6841	2	66
ANGULO MAMPARA 90° BSC17	4	161	BISAGRA SEGURIDAD C/R BS15	5	176	CIERRE CORREDERA 6845	2	62
ANGULO PESANTE AN12	9	315	BISAGRA SEGURIDAD S/R BS16	5	176	CIERRE CORREDERA 6847	2	66
ANGULO PESANTE AN13	9	315	BISAGRA SIMPLE ACCION BS11	5	175	CIERRE CORREDERA 6859	2	64
ANGULO PESANTE AN14	9	315	BISAGRA SOLAPADA BS24	5	192	CIERRE CORREDERA 6865	2	66
ANGULO PESANTE AN15	9	316	BISAGRA SOLAPADA BS25	5	192	CIERRE ESTUCHE CC11	5	189
ANGULO PESANTE AN16	9	316	BISAGRA TAQUILLA CB28	4	153	CIERRE MAGNETICO IM2	8	248
ANGULO PESANTE AN17	9	316	BISAGRA Y PISTON CANAPE BCP4	13	382	CIERRE MAGNETICO IM3	8	249
ANGULO PESANTE AN18	9	316	BOCALLAVE PERA 131	1	49	CIERRE MAGNETICO IAS	8	249
ANGULO REFUERZO AN1	9	308	BOCALLAVE PERA 545	1	48	CIERRE PRESION 6801	2	56
ANGULO REFUERZO AN2	9	309	BOCALLAVE PERA 575	1	48	CIERRE PRESION 6805	2	57
ANGULO REFUERZO AN4	9	309	BOCALLAVE PERA 707	1	49	CIERRE PRESION 6857	2	57
ANGULO REFUERZO AN5	9	310	BOCALLAVE PERA 727	1	49	CIERRE PRESION 6858	2	56
ANGULO REFUERZO AN6	9	310	BOCALLAVE PERA 787	1	49	CIERRE PRESION 6864	2	56
ANGULO REFUERZO AN7	9	310	BOCALLAVE PERA 848	1	48	CIERRE PRESION CP1	3	130
ANGULO REFUERZO AN8	9	310	BOCALLAVE PERA 898	1	48	CIERRE PRESION CP2	3	130
ANGULO REFUERZO AN9	9	311	BOCALLAVE PERA 949	1	49	CIERRE PRESION CP3	3	130
ANGULO SUPER AN3	9	307	BURLETE ADHESIVO FLECO BLT4	3	119	CIERRE SEGURIDAD REGULABLE S17	15	399
ANGULO TAPA AN20	8	278	BURLETE ADHESIVO LABIO BLT5	3	119	CIERRE SEGURIDAD S16	15	399
ANGULO TRASERA AN21	8	278	BURLETE ADHESIVO MADERA BLT3	3	119	CIERRE TOCA-TOCA IM4	8	249
ANGULO TRASERA AN22	8	278	BURLETE ADHESIVO PVC BLT1	3	119	CIERRE VENTANA CV1	3	129
ANILLA LLAVE LLV3	15	414	BURLETE AUTOMATIC BLT11	3	120	CILINDRO SEGURIDAD CS1	3	102-103
ANILLA PLACA TOLDOS AP3	10	331	BURLETE BASCULANTE ALUM BLT6	3	120	CILINDRO SEGURIDAD CS2	3	106-107
ANILLA REDONDA CT17	8	236	BURLETE BASCULANTE ALUM BLT10	3	120	CILINDRO SEGURIDAD CS4	3	104-105
ANILLA SOLDADA AP4	10	330	BURLETE BASCULANTE MADERA BLT2	3	121	CILINDRO SEGURIDAD POMO CS6	3	111
ANILLA SOLDADA AP6	10	330	BURLETE EMBUTIR BLT9	3	120	CILINDRO SERRETA CS3	3	108-110
ANILLA TUBO CT3	8	236	BURLETE FREGADERO BLT12	11	349	CILINDRO SERRETA POMO CS7	3	111
ARO REDUCTOR VN3	11	351	BURLETE GARAJE FLECOS BLT8	3	121	CINTA CIERRE CT15	8	239
ASA ABATIBLE TRM12	6	205	BURLETE GARAJE LABIO BLT7	3	121	CINTA CIERRE CT16	8	239
ASA ABATIBLE TRM13	6	205	CABINA CORREDERA CB21	4	152; 158	CINTA PERSIANA PR26	14	396
ASA CIERRE 6849	2	62	CADENA BOLAS CDN8	15	410	CLAVO 4 PICOS CL5	3	98
ASA COMODILLA TRM10	6	204	CADENA CATEDRAL CDN7	15	409	CLAVO 8 PICOS CL4	3	98
ASA COMODILLA TRM11	6	204	CADENA OVAL LISA CDN2	15	408	CLAVO GOLF CL2	3	98
ASA CORREDERA 6809	2	61	CADENA RECTA GRABADA CDN4	15	409	CLAVO PIRAMIDE CL3	3	98
ASA CORREDERA 6862	2	61	CADENA RECTA LISA CDN1	15	408	CLAVO REDONDO CL1	3	98
ASA PLACA 6803	2	61	CADENA RECTA TORCIDA CDN3	15	408	CODO 45° HORIZONTAL VN8	11	352
ASA PLACA 6804	2	60	CADENA REDONDA GRABADA CDN5	15	409	CODO 45° REDONDO VN7	11	352
ASA PLACA 6843	2	58-59	CADENA TORCIDA LISA CDN6	15	409	CODO 90° HORIZONTAL VN11	11	354
BANDEJA VIERTEAGUAS ECR7	11	341	CAJA ANILLAS LLAVES LLV2	15	414	CODO 90° MIXTO VN12	11	354
BISAGRA 3 CUERPOS 6867	2	67	CAJA LLAVERO PORTAETIQUETAS PTQ1	15	413	CODO 90° REDONDO VN9	11	352
BISAGRA 3 NUDOS 6868	2	67	CAJETIN OBRA PR3	14	389	CODO 90° VERTICAL VN10	11	354
BISAGRA 40/20 6813	2	67	CAJON LATERAL SOFT GC13	7	218	COLGADOR BIVALENTE CG4	10	323
BISAGRA 5005 BS27	5	186	CANDADO ARCO LARGO CN2	15	403	COLGADOR COCINA CG5	10	324
BISAGRA 814 BS29	5	187	CANDADO ARCO NORMAL CN1	15	402; 405	COLGADOR CUADROS CG12	10	327
BISAGRA 816 BS30	5	188	CANDADO ARCO NORMAL CN4	15	402; 405	COLGADOR CUADROS CG16	10	328
BISAGRA 840 BS31	5	188	CANDADO COMBINACION CABLE CN6	15	404	COLGADOR CUADROS CG17	10	328
BISAGRA ALAS BS6	5	191	CANDADO COMBINACION CN5	15	404	COLGADOR CUADROS CG18	10	327
BISAGRA ALAS BS7	5	191	CANDADO COMBINACION CN8	15	404	COLGADOR CUADROS CG19	10	327
BISAGRA BIOMBO BS20	5	192	CANDADO FURGONETA CN7	15	406	COLGADOR ESCUADRA CG3	10	323
BISAGRA BS17	5	177	CANDADO RECTANGULAR CN3	15	403	COLGADOR ESCUADRA CG6	10	324
BISAGRA BS18	5	176	CANTO ADHESIVO CAN1	8	263	COLGADOR ESCUADRA TRIANGULO CG7	10	325
BISAGRA CAZOLETA 165° BC7	5	194	CANTO MELAMINA CAN2	8	263	COLGADOR MUEBLE CG10	10	325
BISAGRA CAZOLETA 30° BC8	5	195	CARCASA GUIA CINTA PR12	14	390	COLGADOR MUEBLE CG22	10	326
BISAGRA CAZOLETA 45° BC9	5	195	CARRIL SUELO POL10	8	247	COLGADOR MUEBLE CG8	10	325
BISAGRA CAZOLETA 90° BC12	5	195	CASCABEL LATON CCB1	15	415	COLGADOR MUEBLE CG9	10	325
BISAGRA CAZOLETA 90° BC13	5	195	CERRADERO 40/20 6850	2	74	COMPAS CABALLETE BCP10	13	386
BISAGRA CAZOLETA BC1	5	193	CERRADERO CRISTAL CCR2	4	159	COMPAS ELEVABLE BCP6	13	384
BISAGRA CAZOLETA BC2	5	193	CERRADERO ESCUADRA CM11	8	241	COMPAS ELEVABLE BCP8	13	384
BISAGRA CAZOLETA CLIP BC3	5	193	CERRADERO EUROPEO 6851	2	74	COMPAS ESCALERA BCP11	13	386
BISAGRA CAZOLETA PISTON BC5	5	194; 196	CERRADERO LENGÜETA 6818	2	65	COMPAS PUERTA BCP7	13	384
BISAGRA CAZOLETA PISTON-TETON BC6	5	194	CERRADURA ARCHIVADOR CM10	8	243	CONDENA PICAPORTE PCT4	5	169
BISAGRA CAZOLETA PUSH BC11	5	194	CERRADURA ARMARIO CM9	8	240	CONTERA CUADRADA CNT3	12	375
BISAGRA CAZOLETA SOBREPONER BC10	5	196	CERRADURA BUZON CM4	8	245	CONTERA CUADRADA CNT5	12	374
BISAGRA CAZOLETA TETON BC4	5	193	CERRADURA BUZON CM5	8	245	CONTERA METALICA PR20	14	395
BISAGRA COMPAS BCP12	13	385	CERRADURA COMBINACION CM13	8	245	CONTERA P/MULETAS CNT9	12	374
BISAGRA COMPAS BCP5	13	385	CERRADURA CRISTAL CCR1	4	159	CONTERA RECTANGULAR CNT4	12	376
BISAGRA COMPAS BCP9	13	385	CERRADURA EMBUTIR CM15	8	242	CONTERA REDONDA CNT1	12	374
BISAGRA COMPAS DESMONTABLE 6839	2	75	CERRADURA FALLEBA CM18	8	242	CONTERA REDONDA CNT10	12	372
BISAGRA COMPAS EUROPEO 6838	2	75	CERRADURA MUEBLE CM1	8	240	CONTERA REDONDA CNT2	12	375
BISAGRA CRISTAL BSC21	5	185	CERRADURA MUEBLE GANCHO CM2	8	240	CONTERA REDONDA CNT6	12	374
BISAGRA CRISTAL BSC22	5	185	CERRADURA MUEBLE HEBILLA CM19	8	243	CONTERA REDONDA CNT7	12	372-373
BISAGRA CRISTAL BSC23	5	185	CERRADURA PICOLORO CRR3	5	172	CONTERA REDONDA CNT8	12	373
BISAGRA DOBLE ACCION BS10	5	175	CERRADURA PULSAR CM3	8	243	CONTRACIERRE ZAMAK 6819	2	65
BISAGRA DOBLE ACCION BS12	5	175	CERRADURA SOBREPONER CM16	8	242	COPETE CLASSIC CPT1	11	344
BISAGRA ELEVABLE BS26	7	212	CERRADURA SOBREPONER CM17	8	242	COPETE ROUND CPT2	11	345
BISAGRA ESTUCHE BS22	5	189	CERRADURA TAQUILLA CM14	8	241	CORBATERO VARILLA IA8	8	225
BISAGRA EU 6812	2	67	CERRADURA VITRINA CM6	8	244	CORCHETE CORTINA CT11	8	238

ALFABÉTICO

Descripción	Familia	Pág.	Descripción	Familia	Pág.	Descripción	Familia	Pág.
CORCHETE CORTINA CT12	8	237	FIELTRO ADHESIVO DZ7	8	288	MANILLA 919	1	25
CORCHETE CORTINA CT5	8	237	FIELTRO ADHESIVO DZ8	8	289	MANILLA 959	1	33
CORCHETE CORTINA CT9	8	237	FIELTRO ADHESIVO DZ9	8	288	MANILLA 989	1	33
CORCHETE GUIA CT10	8	238	FRENO SUPERIOR RUA6	8	246	MANILLA BASCULANTE 231	1	47
CREMONA 1 PATILLA 6828	2	70	GALLETA MADERA ENS9	8	284	MANILLA CREMONA 414	1	43
CREMONA 2 PATILLAS 6814	2	69	GANCHO COLGADOR CG1	10	322	MANILLA FACHADA 6848	2	68
CREMONA 2 PATILLAS 6815	2	69	GANCHO CORTINA CT6	8	238	MANILLA MULTIPUNTO 6806	2	68
CREMONA 2 PATILLAS 6816	2	69	GANCHO FORMA S CG23	10	328	MANILLA MULTIPUNTO 6855	2	68
CREMONA 2 PATILLAS 6817	2	69	GANCHO PLACA FIJO AP7	10	330	MANILLA P/METALICA 232	1	47
CREMONA 2 PATILLAS 6829	2	70	GANCHO PLACA MOVIL AP5	10	330	MANILLA SIPLACA 181	1	43
CREMONA 2 PATILLAS 6856	2	72	GANCHO X CG13	10	327	MANILLON 1666	1	31
CREMONA 2 PATILLAS LL/I 6830	2	70	GARFIO CORTINA FRENTE CT7	8	237	MANILLON 1777	1	29
CREMONA AC-20 6835	2	73	GARFIO CORTINA TECHO CT8	8	237	MANILLON 202	1	26
CREMONA C/MUELLE 6832	2	71	GARRA PRECERCO PRC2	3	118	MANILLON 242	1	17
CREMONA FRONTAL 6863	2	73	GARRA PRECERCO PRC3	3	118	MANILLON 272	1	16
CREMONA PATILLA U 6831	2	70	GOLPETE 6810	2	75	MANILLON 505	1	24-25
CREMONA SEGURIDAD 6833	2	71	GOLPETE EU 6808	2	75	MANILLON 565	1	8
CREMONA SEGURIDAD 6834	2	72	GRAPA SUJECION GRP3	11	349	MANILLON 575	1	9
CUADRADILLO CDD1	3	114	GRAPA SUJECION GRP4	11	349	MANILLON 585	1	10-11
CUADRADILLO EXPANSION CDD3	3	114	GRAPA TRASERA GRP2	8	277	MANILLON 595	1	13
CUADRADILLO RANURADO CDD2	3	114	GRAPA TRASERA RECTANGULAR GRP1	8	277	MANILLON 606	1	37
CUBERTERO CBT1	11	342	GUARDALLAVES CAJA COMBINACION CN11	15	407	MANILLON 656	1	15
CUÑA MADERA PRC4	3	118	GUARDALLAVES CAJA COMBINACION CN9	15	407	MANILLON 666	1	30
CUÑA NIVELADORA NV11	8	287	GUARDALLAVES CANDADO COMBINACION CN10	15	407	MANILLON 6854	2	79
CUÑA NIVELADORA NV14	8	287	GUARDAPARKING VERTICAL GPK1	15	408	MANILLON 686	1	20
DEDAL EMBUTIR DDL1	3	138	GUIA CAJON GC1	7	213	MANILLON 6860	2	78
DEDAL EMBUTIR DDL2	3	138	GUIA CAJON GC12	7	212	MANILLON 6861	2	79
DESILIZANTE ADHESIVO DZ5	8	287	GUIA CINTA PERSIANA PR10	14	390	MANILLON 707	1	36
DESILIZANTE ATORNILLAR DZ10	8	287	GUIA CINTA PERSIANA PR11	14	390	MANILLON 727	1	23
DESILIZANTE ATORNILLAR DZ6	8	287	GUIA CUADRO PUSH GC10	7	218	MANILLON 777	1	28
DESILIZANTE CLAVO DZ1	8	286	GUIA CUADRO SOFT GC9	7	218	MANILLON 787	1	21
DESILIZANTE CLAVO SD DZ4	8	286	GUIA PORTATECLADO GC14	7	219	MANILLON 797	1	27
DESILIZANTE FIELTRO DZ2	8	286	GUIA TELESCOPICA 36mm GC4	7	215	MANILLON 989	1	33
DESILIZANTE METALICO DZ3	8	286	GUIA TELESCOPICA 45mm GC5	7	215	MANILLON CURVA MN1	3	95
EMBELLECEDOR FACETADO SC2	9	296	GUIA TELESCOPICA 53mm GC6	7	217	MANILLON DESPLAZADO 6866	2	78
EMBELLECEDOR LISO SC1	9	296	GUIA TELESCOPICA PUSH GC8	7	216	MANILLON DESPLAZADO MN6	3	94
EMBELLECEDOR MIRILLA MR3	3	97	GUIA TELESCOPICA SOFT GC7	7	216	MANILLON DESPLAZADO MN8	3	94
EMBELLECEDOR RECOGEDOR PR6	14	389	GUIA TELESCOPICA SOFT-PUSH GC11	7	217	MANILLON HUESO MN9	3	95
EMBELLECEDOR RECTANGULAR VN16	11	353	HEMBRILLA ABIERTA HM2	10	332	MANILLON RECTO MN2	3	95
EMBELLECEDOR REDONDO VN15	11	353	HEMBRILLA SOLDADA HM1	10	332	MANILLON RECTO MN3	3	95
EMPALME MIXTO VN6	11	351	IMAN PETANCA IM33	8	257	MANILLON TORNEADO MN4	3	94
EMPALME RECTANGULAR VN5	11	351	IMAN PIZARRA IM7	8	249	MANILLON TORNEADO MN5	3	94
EMPALME REDONDO VN4	11	351	JUNTA MARCO PCR10	3	150	MANILLON TORNEADO MN7	3	94
EMPALME TUBO TA5	8	228	KIT ABATIBLE 40/20 6852	2	74	MARCO MICROONDAS MCR1	11	343
EMPALME UNION CB20	4	155	KIT ABATIBLE EUROPEO 6853	2	74	MEDIA LUNA MDL1	8	276
ENGANCHE CAMA SMR3	8	292	KIT CORREDERA PCR6	3	148	MEDIA LUNA MDL2	8	276
ENGANCHE EX1	8	270	KIT PUERTA CORREDERA PCR2	3	146	MEDUJA REJILLA VEGETAL RV2	15	414
ENGANCHE EX2	8	271	KIT PUERTA CORREDERA PCR3	5	170	MICROGUIA 17mm GC2	7	214
ENGANCHE EX3	8	272	KIT PUERTA CORREDERA PCR4	5	171	MICROGUIA 27mm GC3	7	214
ENGANCHE EX5	8	269	KIT PUERTA CORREDERA PCR5	5	171	MIRILLA 14mm 180° MR1	3	96-97
ENGANCHE EXCENTRICA EX4	8	272	LAGRIMA ADHESIVA LGM1	8	258	MIRILLA 16mm 180° MR2	3	96
ENGANCHE FRONTAL ENG1	7	213	LAGRIMA ADHESIVA LGM2	8	258	MIRILLA DIGITAL MD1	3	97
ENGANCHE LARGUERO SMR4	8	292	LAGRIMA ADHESIVA LGM3	8	258	MOSQUITERA CORREDERA MR2	2	90
ENGANCHE MOSQUITERA MQ1	2	90	LAGRIMA ADHESIVA LGM4	8	258	MUELLE CIERRAPUERTAS ESPIRAL MC4	5	174
ENGANCHE STRONG ENG2	8	279	LAGRIMA ADHESIVA LGM5	8	259	MUELLE CIERRAPUERTAS MC2	5	174
ENGANCHE STRONG ENG3	8	279	LAGRIMA ADHESIVA LGM6	8	259	MUELLE CIERRAPUERTAS MC3	5	174
ENSAMBLE ENCIMERA ENS1	8	284	LAGRIMA ADHESIVA LGM7	8	259	MULETILLA C/INDICADOR CB1	4	152
ENSAMBLE ENCIMERA ENS2	8	284	LAGRIMA EMBUTIR LGM8	8	259	MULETILLA MANILLA 10014	1	52
ESCUADRA BAÑERA SMR5	8	293	LAMA PERSIANA PR24	14	395	MULETILLA MANILLA 10098	1	52
ESCUADRA MESA ESM1	8	289	LED SENSOR LD2	8	227	MULETILLA MINUSVALIDO CB11	4	152
ESCUADRA MESA ESM2	8	289	LETRA LATON LTR1	3	142-143	MULETILLA ROSETA 1095	1	52
ESCUADRA PLANA PLC4	9	313	LLAMADOR INGLES LLM1	3	92	MULETILLA ROSETA 131	1	50
ESCUADRA PLANA PLC5	9	314	LLAVE IGUAL CERRADURA CM12	8	241	MULETILLA ROSETA 545	1	50
ESCUADRA UNION CB8	4	156	LLAVE MULTIPLE CONTADOR LLV4	15	416	MULETILLA ROSETA 575	1	50
ESCUADO BOCALLAVE 6811	2	77	LLAVERO ANILLA LLV1	15	413	MULETILLA ROSETA 616	1	51
ESCUADO BOCALLAVE EBA1	8	243	LLAVERO PORTAETIQUETAS PTQ2	15	413	MULETILLA ROSETA 707	1	51
ESCUADO SEGURIDAD ES1	3	101	MANILLA 010	1	27	MULETILLA ROSETA 727	1	50
ESCUADO SEGURIDAD ES2	3	101	MANILLA 1646	1	32	MULETILLA ROSETA 787	1	51
ESCUADO SEGURIDAD ES3	3	101	MANILLA 1666	1	31	MULETILLA ROSETA 848	1	51
ESCUADO TAPAPOMO ES4	3	116	MANILLA 1777	1	29	MULETILLA ROSETA 898	1	50
ESCUADO TAPAPOMO ES5	3	116	MANILLA 202	1	26	MULETILLA ROSETA 949	1	50
ESCURREPLATOS ACOPLABLE ECR5	11	340	MANILLA 242	1	17	NEODIMIO ARO AVELLANADO IM31	8	256
ESCURREPLATOS ECR3	11	341	MANILLA 252	1	19	NEODIMIO BLOQUE IM30	8	255
ESCURREPLATO-VASO ECR1	11	340	MANILLA 272	1	16	NEODIMIO DISCO IM28	8	255
ESCURREPLATO-VASO ECR2	11	340	MANILLA 282	1	18	NEODIMIO DISCO IM29	8	254
ESCURREVASOS ECR4	11	341	MANILLA 292	1	18	NEODIMIO GANCHO IM32	8	256
ESPARRAGO 2 ROSCAS TRN14	8	283	MANILLA 327	1	32	NIVELADOR EMBUTIR NV2	12	368
ESPARRAGO R/MADERA TRN13	8	283	MANILLA 343	1	22	NIVELADOR PATA ECO NV9	12	369
ESPARRAGO TNE10	8	280	MANILLA 505	1	24	NIVELADOR PLANO NV4	12	370
ESPIGA MADERA ENS5	8	285	MANILLA 515	1	12	NIVELADOR PLANO NV5	12	371
ESPIGA METALICA ENS8	8	284	MANILLA 565	1	8	NIVELADOR PLANO NV6	12	371
ESPIRAL VISILLO EV1	8	226	MANILLA 575	1	9	NIVELADOR PLANO NV7	12	370
ESQUINERO ALUMINIO AN23	9	304	MANILLA 585	1	10	NIVELADOR POMO NV8	12	370
ESTERILLA ANTIDESLIZANTE DZ11	11	342	MANILLA 606	1	37	NIVELADOR REGULABLE NV1	12	369
ESTERILLA ANTIDESLIZANTE DZ12	11	342	MANILLA 666	1	30	NIVELADOR REGULABLE NV12	12	368
ESTUCHE RODAMIENTOS RD41	2	79	MANILLA 6800	2	54	NIVELADOR REGULABLE NV13	12	368
EXCENTRICA 15 EX6	8	273	MANILLA 6802	2	54	NIVELADOR REGULABLE NV3	12	369
EXCENTRICA 25 EX7	8	274	MANILLA 6824	2	58	NIVELADOR TOP NV10	12	368
EXCENTRICA 35 EX8	8	274	MANILLA 6827	2	55	NUDO CONECTOR CB6	4	155
EXPULSOR C/BASE AMORTIGUADOR IM23	8	252	MANILLA 6842	2	54	NUMERO LATON NM1	3	142
EXPULSOR C/BASE AMORTIGUADOR IM8	8	252	MANILLA 6846	2	55	OJO DE BUEY OB1	3	96
EXPULSOR C/BASE IMAN IM22	8	252	MANILLA 686	1	20	OVALLILLO ARANDELA OV3	8	277
EXPULSOR C/BASE IMAN IM9	8	252	MANILLA 702	2	55	OVALLILLO OV2	5	179
EXPULSOR EMBUTIR AMORTIGUADOR IM10	8	253	MANILLA 703	1	47	OVALLILLO PERNIO OV1	5	179
EXPULSOR EMBUTIR AMORTIGUADOR IM38	8	253	MANILLA 704	1	46	PALOMILLA 3 POSICIONES PLM6	9	305
EXPULSOR EMBUTIR IMAN IM11	8	253	MANILLA 707	1	36	PALOMILLA ALUMINIO PLM7	9	306
EXPULSOR EMBUTIR IMAN IM12	8	253	MANILLA 727	1	22	PALOMILLA ALUMINIO PLM8	9	304
EXTENSION ENCIMERA ENC3	11	346	MANILLA 777	1	28	PALOMILLA CLASICA PLM1	9	306
EXTENSION ENCIMERA ENC6	11	346	MANILLA 787	1	21	PALOMILLA ORNAMENTAL PLM5	9	305
FERRITA BLOQUE IM35	8	257	MANILLA 797	1	27	PALOMILLA PLUS PLM2	9	306
FERRITA DISCO IM34	8	257						

ÍNDICE DE PRODUCTOS

ALFABÉTICO

Descripción	Familia	Pág.	Descripción	Familia	Pág.	Descripción	Familia	Pág.
PALOMILLA REFORZADA PLM4	9	305	PICAPORTE TUBULAR PCT3	5	169	PORTAESTANTE PERNO PE17	8	267
PALOMILLA SUPER PLM3	9	307	PICAPORTE VAIVEN PCT6	5	170	PORTAESTANTE PRESION PE11	8	268
PANTALONERO 11 PERCHAS IA2	8	224	PINZA ESCUADRA CB17	4	156	PORTAESTANTE REDONDO PE14	8	268
PANTALONERO 8 PERCHAS IA1	8	224	PINZA ESQUADRA CB18	4	156	PORTAESTANTE SAFETY PE6	8	266
PAPEL MAGNETICO FOTOS IM36	15	416	PINZA MAMPARA BSC15	4	161	PORTAESTANTE SAFETY PE7	8	266
PASADOR 700	3	137	PINZA UNION CB12	4	156	PORTAESTANTE VENTOSA PE15	8	269
PASADOR ALUMINIO PS5	2	76-77	PINZA UNION TUBO CB7	4	154	PORTAESTANTE VITRINA PE5	8	264
PASADOR COLA MILANO PS13	3	134	PINZA ZOCALO MADERA/ALUMINIO ZCL5	12	367	PORTAETIQUETAS MAGNETICO IM37	15	416
PASADOR EMBUTIR PS10	3	137	PINZA ZOCALO PVC/ALUMINIO ZCL6	12	367	PORTAETIQUETAS PTQ3	3	144
PASADOR EMBUTIR PS8	3	137	PISTON GAS ABATIBLE BCP3	13	383	PORTAETIQUETAS PTQ4	3	144
PASADOR EMBUTIR PS9	3	137	PISTON GAS BCP1	13	383	PORTASTANTE ROSCADO PE13	8	268
PASADOR EUROPEO 6837	2	73	PISTON GAS ELEVABLE BCP2	13	383	PROTECTOR ARMARIO SI9	15	400
PASADOR FORJA PS11	3	133	PIVOTE CENTRADOR MESA ESM3	8	289	PROTECTOR CAJONES SI10	15	400
PASADOR HIERRO PS1	3	134	PIVOTE SUJETA CAMPANA PVT1	11	350	PROTECTOR CAMPANA PTR2	11	349
PASADOR LATON PS7	3	136	PLACA ADHESIVA IM25	8	254	PROTECTOR COSTADO FRIGO PTR3	11	347
PASADOR PORTACANDADO PS12	3	136	PLACA AMARRE AP10	10	329	PROTECTOR COSTADO FRIGO PTR4	11	347
PASADOR RULETA 6825	2	77	PLACA AMARRE AP11	10	329	PROTECTOR ENCHUFE FIJO SI13	15	401
PASADOR RULETA PS4	3	134	PLACA AMARRE AP8	10	329	PROTECTOR ENCHUFE GIRATORIO SI12	15	401
PASADOR SEGURIDAD PS6	3	136	PLACA AMARRE AP9	10	329	PROTECTOR ESQUINA SI3	15	398
PASADOR ZAMAK PS2	3	133	PLACA ATORNILLAR IM26	8	254	PROTECTOR ESQUINA SI4	15	399
PASADOR ZAMAK PS3	3	133	PLACA BOCALLAVE PLP2	3	100	PROTECTOR ESQUINA SI5	15	399
PATA CANAPE PT26	12	362	PLACA CARTELA PLC3	9	313	PROTECTOR FONDO FREGADERO PTR1	11	349
PATA CANAPE PT27	12	362	PLACA CIEGA PLP1	3	99	PROTECTOR TIRADOR ARMARIO SI8	15	400
PATA ECO CUADRADA PT24	12	361	PLACA CIEGA PLP3	3	99	PROTECTOR VITROCERAMICA PTR5	11	347
PATA ECO REDONDA PT23	12	361	PLACA CLAVO IM24	8	254	PROTECTOR ZOCALO PTR7	11	348
PATA MESA PLEG/REG PT9	12	359	PLACA COLGADOR CG11	10	326	PUERTA CORREDERA RUSTICO PCR1	3	146-147
PATA MESA PLEGABLE PT5	12	358	PLACA COLGADOR CG14	10	326	PUNTA LATON PNT2	5	189
PATA MESA PLEGABLE PT7	12	358	PLACA COLGADOR CG15	10	326	PUNTILLA PERDIDA PNT1	3	116
PATA MESA PLEGABLE PT8	12	358	PLACA COLGADOR CG2	10	322	RECOGEDOR ABATIBLE PR2	14	388
PATA MESA PT6	12	360	PLACA COLGADOR CG20	10	324	RECOGEDOR EMBUTIR PR1	14	388
PATA MESA REGULABLE PT10	12	359	PLACA COLGADOR CG21	10	324	RECOGEDOR METALICO PR5	14	389
PATA MUEBLE CUADRADA PT1	12	363	PLACA CUADRADA PLC6	9	311	RECOGEDOR PLASTICO PR4	14	389
PATA MUEBLE CUADRADA PT15	12	365	PLACA CUADRADILLO CDD5	3	115	REDUCTOR CUADRADILLO CDD7	3	115
PATA MUEBLE CUADRADA PT16	12	365	PLACA EMBUTIR IM27	8	254	REDUCTOR CUADRADILLO CDD8	3	115
PATA MUEBLE CUADRADA PT19	12	365	PLACA ESPARRAGO CDD6	3	115	REGLETA ESCURREPLATO ECR6	11	341
PATA MUEBLE CUADRADA PT21	12	363, 369	PLACA FORMA T PLC11	9	317	REJILLA EMPOTRAR RJV3	11	356
PATA MUEBLE CUADRADA PT22	12	363, 369	PLACA IDENTIFICATIVA PLP6	3	141	REJILLA FRIGO-HORNO RJV1	11	343
PATA MUEBLE REDONDA PT11	12	366	PLACA IDENTIFICATIVA PLP7	3	141	REJILLA MOSQUITERA RJV4	11	356
PATA MUEBLE REDONDA PT12	12	367	PLACA IDENTIFICATIVA PLP8	3	141	REJILLA PLANA RJV2	11	356
PATA MUEBLE REDONDA PT13	12	364	PLACA IDENTIFICATIVA PLP9	3	141	REJILLA VEGETAL RV1	15	414
PATA MUEBLE REDONDA PT14	12	364	PLACA PESANTE PLC9	9	314	REMATE BELLOTA PMN6	3	140
PATA MUEBLE REDONDA PT17	12	367	PLACA PISA PUERTA PLP4	3	100	REMATE BOLA PMN5	3	140
PATA MUEBLE REDONDA PT18	12	364	PLACA PISA PUERTA PLP5	3	100	REMATE TUBO CT1	8	236
PATA MUEBLE REDONDA PT2	12	366	PLACA RECTA PLC1	9	312	REMATE TUBO CT2	8	236
PATA MUEBLE REDONDA PT20	12	367	PLACA RECTA PLC10	9	314	RETENEDOR CADENILLA RT2	3	128
PATA MUEBLE REDONDA PT3	12	366	PLACA RECTA PLC2	9	312	RETENEDOR FORMA S RT6	3	129
PATA MUEBLE REDONDA PT4	12	366	PLACA RECTA PLC3	9	311	RETENEDOR PIE RT3	3	128
PATA REGULABLE CB10	4	154	PLACA RECTANGULAR PLC7	9	311	RETENEDOR PUERTA CLIP3	3	127
PATA SOMIER PT25	12	362	PLACA TRIANGULO PLC13	12	371	RETENEDOR PUERTA RT1	3	128
PERCHA CUADRADA PER11	10	337	PLACA TUERCA PLC12	9	317	RETENEDOR PUERTA RT4	3	127
PERCHA DOBLE PER14	10	336	POLEA GUIA 698	3	149	RETENEDOR PUERTA RT5	3	127
PERCHA DOBLE PER2	10	336	POLEA METALICA PR19	14	395	RETENEDOR VENTANA CLIP1	3	129
PERCHA EMBUTIR PER10	10	333	POLEA PLASTICO PR21	14	394	RETENEDOR VENTANA CLIP2	3	129
PERCHA EMBUTIR PER9	10	333	POLEA PUERTA CORREDERA POL8	8	247	RINCON ZOCALO ALUMINIO ZCL4	11	348
PERCHA FORJA PER5	10	334	POLEA SUPERIOR ESCUADRA POL9	8	247	RODAMIENTO 157 RD13	2	82
PERCHA FORJA PER6	10	334	POLEA TENDER GANCHO POL5	15	411	RODAMIENTO 158 RD14	2	83
PERCHA FORJA PER7	10	335	POLEA TENDER GANCHO POL6	15	411	RODAMIENTO 158/S RD15	2	83
PERCHA FORJA PER8	10	335	POLEA TENDER TORNILLO POL3	15	412	RODAMIENTO 172 RD7	2	80
PERCHA GANCHOS PER15	10	337	POLEA TENDER TORNILLO POL4	15	412	RODAMIENTO ALTA RD11	2	81
PERCHA PROBADOR PER3	10	338	POLEA TENDER TUERCA POL1	15	412	RODAMIENTO ALUGOM RD20	2	81
PERCHA REDONDA PER1	10	337	POLEA TENDER TUERCA POL2	15	412	RODAMIENTO ALUPRON RD21	2	81
PERCHA RUSTICA PER16	10	334	POLEA TENDER TUERCA POL7	15	412	RODAMIENTO CLIMALIT RD17	2	83
PERCHA RUSTICA PER17	10	335	POLIPELO TIRA PCR9	3	150	RODAMIENTO CLL/104 RD18	2	84
PERCHA SIMPLE PER12	10	336	POMO ARMARIO BOLA PA1	6	203	RODAMIENTO CO-1B RD31	2	85
PERCHA TOPE PER18	4	154	POMO ARMARIO BOLA PA10	6	203	RODAMIENTO CO-22 RD19	2	84
PERCHA TROBOL PER4	10	338	POMO ARMARIO BOLA PA11	6	203	RODAMIENTO CO-22 RD33	2	85
PERCHERO ABATIBLE IA5	8	226	POMO ARMARIO BOLA PA9	6	203	RODAMIENTO CO-22 RD8	2	80
PERFIL CORTINA CT14	8	239	POMO ARMARIO CILINDRICO PA15	6	201	RODAMIENTO CO-36 RD32	2	85
PERFIL ESQUINERO CB16	4	157	POMO ARMARIO CONICO PA7	6	201	RODAMIENTO ELITE RD23	2	82
PERFIL GUIA PCR7	3	149	POMO ARMARIO CUADRADO PA14	6	202	RODAMIENTO ENDASA RD10	2	80
PERFIL L INTERIOR CB13	4	157	POMO ARMARIO CUADRADO PA4	6	202	RODAMIENTO INASA RD12	2	82
PERFIL L EXTERIOR CB14	4	157	POMO ARMARIO MARGARITA PA13	6	204	RODAMIENTO INASA RD16	2	83
PERFIL MAMPARA BAÑERA PF4	4	164	POMO ARMARIO MUESCA PA12	6	202	RODAMIENTO INASA RD9	2	80
PERFIL MAMPARA BURBUJA PF3	4	164	POMO ARMARIO MUESCA PA6	6	202	RODAMIENTO MAMPARA RD1	2	87
PERFIL MAMPARA JUNTA PF5	4	165	POMO ARMARIO PLANO PA5	6	204	RODAMIENTO MAMPARA RD2	2	89
PERFIL MAMPARA JUNTA PF8	4	165	POMO ARMARIO PLANO PA8	6	201	RODAMIENTO MAMPARA RD25	2	88
PERFIL MAMPARA MAGNETICO PF1	4	166	POMO MAMPARA BSC12	4	163	RODAMIENTO MAMPARA RD26	2	88
PERFIL MAMPARA MAGNETICO PF2	4	166	POMO MAMPARA BSC13	4	163	RODAMIENTO MAMPARA RD27	2	88
PERFIL MAMPARA VIERTEAGUA PF6	4	164	POMO MAMPARA BSC14	4	163	RODAMIENTO MAMPARA RD28	2	88
PERFIL MAMPARA VIERTEAGUA PF7	4	165	POMO PLACA 6844	2	59	RODAMIENTO MAMPARA RD3	2	89
PERFIL PELDAÑO TJ9	3	121	POMO PUERTA PP1	3	92	RODAMIENTO MAMPARA RD4	2	89
PERFIL PROTECTOR CANTOS SI1	15	398	POMO PUERTA PP2	3	93	RODAMIENTO MAMPARA RD6	2	89
PERFIL PROTECTOR CANTOS SI2	15	398	POMO PUERTA PP3	3	92	RODAMIENTO MOSQUITERA RD5	2	90
PERFIL SUPERIOR CB19	4	157	POMO PUERTA PP4	3	93	RODAMIENTO P-60 RD22	2	81
PERFIL U ARRANQUE CB15	4	157	POMO PUERTA PP5	3	93	RODAMIENTO PERSIANA PR16	14	391
PERNIO C/R PN3	5	178	POMO PUERTA PP6	3	93	RODAMIENTO REGULABLE ALUGOM RD36	2	86
PERNIO PALA 696	5	181	POMO PUERTA PP7	1	44-45	RODAMIENTO REGULABLE ALUPRON RD37	2	86
PERNIO PALA 699	5	181	POMO RECUPERABLE 6807	2	60	RODAMIENTO REGULABLE CORTIZO RD40	2	86
PERNIO PERFIL 695	5	180	POMOS CB4	4	152	RODAMIENTO REGULABLE INASA RD34	2	84
PERNIO RODAMIENTO 694	5	180	PORTACANDADO CC10	3	135	RODAMIENTO REGULABLE INASA RD35	2	84
PERNIO S/R PN4	5	178	PORTAESTANTE ARANDELA PE3	8	265	RODAMIENTO REGULABLE P60/P65 RD39	2	86
PERNIO S/R PN6	5	178	PORTAESTANTE CLAVAR PE16	8	264	RODAMIENTO REGULABLE SILVER RD38	2	86
PERNIO S/R PN7	5	177	PORTAESTANTE CRISTAL PE4	8	265	RODAMIENTO TRIANA RD24	2	82
PERNIO S/R PN9	5	177	PORTAESTANTE CRISTAL PE9	8	267	RODAMIENTO VITRINA RD29	2	85
PERNIO TORNEADO 692	5	180	PORTAESTANTE ESCUADRA PE8	8	266	RODAMIENTO VITRINA RD30	2	85
PERNIO TORNEADO 693	5	180	PORTAESTANTE ESTAMPADO PE12	8	268	ROSETA 020	1	19
PICAPORTE CONDENA PCT1	5	168-169	PORTAESTANTE EURO PE18	8	267	ROSETA 101	1	40
PICAPORTE CONDENA PCT2	5	168	PORTAESTANTE GOMA PE10	8	269	ROSETA 202	1	26
PICAPORTE CRISTAL CCR3	4	159	PORTAESTANTE PALETA PE1	8	267	ROSETA 303	1	41
PICAPORTE RODILLO PCT5	5	170	PORTAESTANTE PE2	8	265	ROSETA 313	1	41

ALFABÉTICO

Descripción	Familia	Pág.	Descripción	Familia	Pág.	Descripción	Familia	Pág.
ROSETA 327	1	32	SOPORTE OCULTO SBO2	9	302	TIRADOR TRM17	6	200
ROSETA 353	1	41	SOPORTE OCULTO SBO3	9	302	TIRADOR TRM18	6	200
ROSETA 363	1	35	SOPORTE OCULTO SBO4	9	302	TIRADOR TRM19	6	200
ROSETA 373	1	42	SOPORTE PASAMANOS PMN1	3	139	TIRADOR TRM2	6	198
ROSETA 383	1	41	SOPORTE PASAMANOS PMN2	3	139	TIRADOR TRM20	6	200
ROSETA 393	1	40	SOPORTE PASAMANOS PMN3	3	139	TIRADOR TRM4	6	198
ROSETA 404	1	42	SOPORTE PASAMANOS PMN4	3	140	TIRADOR TRM5	6	198
ROSETA 454	1	40	SOPORTE PELICANO SP1	9	301	TIRADOR VARILLA TRM9	6	199
ROSETA 464	1	39-40	SOPORTE PELICANO SP2	9	301	TIRANTE FLEJE PR18	14	393
ROSETA 474	1	35	SOPORTE PELICANO SP3	9	301	TOPE 2 PUNTAS TPM1	8	264
ROSETA 484	1	42	SOPORTE PELICANO SP4	9	300	TOPE ALAS AMORTIGUADOR IM20	8	251
ROSETA 494	1	35	SOPORTE PELICANO SP5	9	299	TOPE ALAS IMAN IM21	8	251
ROSETA 515	1	12	SOPORTE PELICANO SP6	9	299	TOPE C/BASE AMORTIGUADOR IM18	8	251
ROSETA 545	1	12	SOPORTE PELICANO SP7	9	300	TOPE C/BASE IMAN IM19	8	251
ROSETA 565	1	8	SOPORTE PELICANO SP8	9	300	TOPE EMBUTIR AMORTIGUADOR IM14	8	250
ROSETA 575	1	9	SOPORTE PERCHAS IA7	8	226	TOPE EMBUTIR AMORTIGUADOR REGULABLE IM16	8	250
ROSETA 585	1	10	SOPORTE PINCHO PR14	14	391	TOPE EMBUTIR IMAN IM15	8	250
ROSETA 595	1	13	SOPORTE POSTE SV6	9	320	TOPE EMBUTIR IMAN REGULABLE IM17	8	250
ROSETA 606	1	37	SOPORTE POSTE SV7	9	320	TOPE PERSIANA PR8	14	394
ROSETA 636	1	13	SOPORTE POSTE SV8	9	319	TOPE PUERTA CLASICO TP9	3	124
ROSETA 686	1	20	SOPORTE POSTE SV9	9	319	TOPE PUERTA CUÑA S115	15	401
ROSETA 707	1	36	SOPORTE RIEL GT4	8	238	TOPE PUERTA LUX TP1	3	125
ROSETA 717	1	15	SOPORTE RODAMIENTO PR15	14	391	TOPE PUERTA LUX TP2	3	125
ROSETA 727	1	22	SOPORTE RODILLOS PR13	14	390	TOPE PUERTA LUX TP7	3	125
ROSETA 737	1	12	SOPORTE SOMIER SMR1	8	293	TOPE PUERTA RETENEDOR TP10	3	124
ROSETA 747	1	13	SOPORTE TECHO STA13	8	234	TOPE PUERTA RETENEDOR TP12	3	124
ROSETA 767	1	15	SOPORTE TECHO STA12	8	234	TOPE PUERTA RETENEDOR TP8	3	124
ROSETA 787	1	21	SOPORTE TECHO STA17	8	234	TOPE PUERTA SETA TP3	3	126
ROSETA 898	1	34	SOPORTE TECHO STA21	8	235	TOPE PUERTA SETA TP4	3	126
ROSETA 909	1	42	SOPORTE TECLADO ST01	7	219	TOPE PUERTA SETA TP5	3	126
ROSETA 919	1	25	SOPORTE TUBO MAMPARA BSC11	4	162	TOPE PUERTA SETA TP6	3	126
ROSETA 949	1	35	SOPORTE TUBO PARED CB5	4	155	TOPE PUERTA STOP TP11	3	127
ROSETA 959	1	33	SOPORTE TV STV1	7	220	TOPE SALVA DEDOS S111	15	400
ROSETA CUADRADA 090	1	34	SOPORTE TV STV2	7	220	TORNILLO ANCLAJE TRN6	8	282
ROSETA CUADRADA 131	1	14	SOPORTE TV STV3	7	220	TORNILLO BISAGRA TRN5	5	196
ROSETA CUADRADA 161	1	14	SOPORTE TV STV4	7	221	TORNILLO CABINA CB25	4	158
ROSETA CUADRADA 191	1	14	SOPORTE TV STV5	7	221	TORNILLO CAMA TRN12	8	292
ROSETA CUADRADA 424	1	39	SOPORTE TV STV6	7	222	TORNILLO CASCABEL TRN15	8	282
ROSETA CUADRADA 434	1	39	SOPORTE TV STV7	7	222	TORNILLO CILINDRO TRN16	3	112
ROSETA CUADRADA 616	1	38	SOPORTE TV STV8	7	222	TORNILLO DOWELL TRN9	8	282
ROSETA CUADRADA 656	1	15	SOPORTE TV STV9	7	221	TORNILLO ENSAMBLE TNE1	8	279
ROSETA CUADRADA 676	1	14	SOPORTE VIGA SV1	9	318	TORNILLO ENSAMBLE TNE6	8	279
ROSETA CUADRADA 848	1	34	SOPORTE VIGA SV2	9	318	TORNILLO ENSAMBLE TNE7	8	278
ROSETA CUADRADA 868	1	38	SOPORTE VIGA SV3	9	318	TORNILLO ENSAMBLE TNE8	8	280
ROSETA CUADRADA 878	1	38	SOPORTE VIGA SV4	9	319	TORNILLO EURO TRN17	8	277
ROSETA CUADRADA 969	1	34	SOPORTE VIGA SV5	9	319	TORNILLO KOMBY TNE3	8	281
RUEDA COSTADO RUM2	12	376	SUJETALUNAS SC3	9	297	TORNILLO MULTICORTE TRN7	6	210
RUEDA EMBUTIR RUM1	12	379	TACHUELA PLANA TCH1	15	415	TORNILLO PASANTE CB22	4	158
RUEDA EMBUTIR RUM7	12	379	TACO GRAFILADO TC1	8	274	TORNILLO PASANTE CB23	4	158
RUEDA EMBUTIR RUM8	12	379	TAPA ENCIMERA ENC1	11	346	TORNILLO PASANTE CB24	4	158
RUEDA INFERIOR RUA3	8	246	TAPA ENCIMERA ENC4	11	346	TORNILLO PASANTE MULTICORTE TRN2	3	117
RUEDA INFERIOR RUA5	8	247	TAPAJUNTAS ESCALON TJ3	3	122	TORNILLO PASANTE TRN1	3	117
RUEDA MUEBLE RUM9	12	379	TAPAJUNTAS ESCALON TJ4	3	122	TORNILLO PASANTE TUBO TRN3	3	117
RUEDA NIDO RUM10	12	380	TAPAJUNTAS ESCALON TJ7	3	123	TORNILLO PRISIONERO TRN4	3	117
RUEDA NIDO RUM11	12	380	TAPAJUNTAS ESCALON TJ8	3	123	TORNILLO SILLA TRN10	8	283
RUEDA NIDO RUM12	12	380	TAPAJUNTAS PLANO TJ1	3	122	TORNILLO TIRADOR TRN8	6	210
RUEDA NIDO RUM13	12	380	TAPAJUNTAS PLANO TJ2	3	122	TORNILLO UNION KOMBY M4 TNE5	8	281
RUEDA PLACA RUM3	12	377	TAPAJUNTAS PLANO TJ5	3	123	TORNILLO UNION KOMBY M6 TNE4	8	281
RUEDA PLACA RUM5	12	378	TAPAJUNTAS PLANO TJ6	3	123	TORNILLO UNION TNE11	8	280
RUEDA ROSCA RUM4	12	377	TAPON ADH 13mm TPN1	8	260	TORNO PERSIANA PR17	14	392-393
RUEDA ROSCA RUM6	12	378	TAPON ADH 17mm TPN2	8	261	TUBO ARMARIO LD1	8	227
RUEDA SUPERIOR RUA1	8	246	TAPON ADH 25mm TPN3	8	261	TUBO ARMARIO TA1	8	228
RUEDA SUPERIOR RUA2	8	246	TAPON ADH BISAGRA TPN4	8	262	TUBO ARMARIO TA2	8	228
RUEDA SUPERIOR RUA4	8	246	TAPON MODULO CREMALLERA TPN7	8	262	TUBO ARMARIO TA3	8	229
SALVA ENCIMERA PTR6	11	347	TAPON PASACABLES TPC1	7	219	TUBO ARMARIO TA4	8	229
SEGURO PERSIANA PR22	14	393	TAPON PLASTICO ENVOLVENTE TPN6	8	262	TUBO CABINA CB9	4	155
SEGURO PERSIANA PR25	14	393	TAPON PLASTICO TPN5	8	262	TUBO EJE OCTOGONAL PR23	14	395
SEGURO PERSIANA PR9	14	393	TENDEDERO BALCON TND2	15	411	TUBO ESQUINERO TA6	8	229
SEGURO VENTANA CORREDERA S114	15	401	TENDEDERO PARED TND1	15	411	TUBO MAMPARA BSC10	4	162
SEPARADOR CRISTAL SC8	9	297	TERMINAL ESPIRAL VISILLO EV2	8	227	TUBO RECTANGULAR VN1	11	350
SOPORTE AIRE ACONDICIONADO AC1	9	303	TERMINAL ESPIRAL VISILLO EV3	8	227	TUBO REDONDO VN2	11	350
SOPORTE C/GARRAFA AC3	9	303	TIRACORDON CORTINA CT18	8	239	TUBO UNION KOMBY TNE2	8	281
SOPORTE CENTRAL STA10	8	233	TIRADOR 242	1	19	TUERCA CIEGA TRC1	8	294
SOPORTE CENTRAL STA2	8	230	TIRADOR 505	1	24	TUERCA EMBOLO TRC7	8	276
SOPORTE CENTRAL STA5	8	231	TIRADOR 575	1	11	TUERCA EMBUTIR TRC3	8	275
SOPORTE CENTRAL STA7	8	232	TIRADOR 666	1	31	TUERCA EMBUTIR TRC4	8	275
SOPORTE CENTRAL STA8	8	232	TIRADOR 686	1	20	TUERCA EMBUTIR TRC5	8	275
SOPORTE CERRADO STA11	8	233	TIRADOR 727	1	23	TUERCA ENSAMBLE TNE9	8	280
SOPORTE CERRADO STA3	8	230	TIRADOR 777	1	29	TUERCA EXPANSIBLE TRC6	8	275
SOPORTE CERRADO STA9	8	233	TIRADOR ALUMINIO TRM6	6	199	TUERCA PUA EMBUTIR TRC2	8	276
SOPORTE CILINDRICO SC4	9	298	TIRADOR ARCO TRM8	6	199	TUERCA RECTANGULAR TRC10	8	292
SOPORTE CRISTAL SC9	9	299	TIRADOR CAJA TRM15	6	205	TUERCA SILLA TRC8	8	283
SOPORTE ESCALERA LITERA SMR6	8	293	TIRADOR CARRUSEL TRM7	6	199	TUERCA TRC9	8	294
SOPORTE ESFERICO SC5	9	298	TIRADOR EMBUTIR BSC8	4	163	UNION ENCIMERA ENC2	11	346
SOPORTE ESPEJOS SC7	9	297	TIRADOR EMBUTIR CUADRADO TE3	6	208	UNION ENCIMERA ENC5	11	346
SOPORTE EXTENSIBLE STA18	8	235	TIRADOR EMBUTIR CUADRADO TE7	6	207	UNION PANELES ENS3	8	284
SOPORTE EXTENSIBLE STA19	8	235	TIRADOR EMBUTIR CUADRADO TE9	6	206	UNION PANELES ENS4	8	284
SOPORTE FRENTE STA16	8	235	TIRADOR EMBUTIR MEDIA LUNA TE13	6	207	VARILLA CUADRADILLO CDD4	3	114
SOPORTE HAMACA AP1	10	331	TIRADOR EMBUTIR OVAL TE11	6	206	VARILLA HUECA VR1	8	294
SOPORTE HAMACA AP2	10	331	TIRADOR EMBUTIR OVAL TE12	6	209	VARILLA MADERA ENS6	8	285
SOPORTE LARGUERO SMR2	8	293	TIRADOR EMBUTIR OVAL TE6	6	207	VARILLA MADERA ENS7	8	285
SOPORTE LATERAL STA15	8	231	TIRADOR EMBUTIR RECTANGULAR TE10	6	206	VENTANILLA MIXTA VN19	11	355
SOPORTE LATERAL STA1	8	230	TIRADOR EMBUTIR RECTANGULAR TE8	6	207	VENTANILLA SALIDA VN17	11	355
SOPORTE LATERAL STA14	8	231	TIRADOR EMBUTIR REDONDO TE5	6	206	VENTANILLA SALIDA VN18	11	355
SOPORTE LATERAL STA20	8	234	TIRADOR EMBUTIR TE1	6	209	ZAPATERO 2 BALDAS IA6	8	225
SOPORTE LATERAL STA4	8	231	TIRADOR EMBUTIR UNERO TE2	6	208	ZAPATERO CAJON EXT IA4	8	225
SOPORTE LATERAL STA6	8	232	TIRADOR EMBUTIR UNERO TE4	6	208	ZAPATERO EXT TOTAL IA3	8	224
SOPORTE MEDIA LUNA SC6	9	298	TIRADOR HIERRO TRM14	6	205	ZOCALO ALUMINIO ZCL1	11	348
SOPORTE MICROONDAS MCR2	11	343	TIRADOR TRM1	6	198	ZOCALO ALUMINIO ZCL3	11	348
SOPORTE OCULTO SBO1	9	302	TIRADOR TRM16	6	201	ZOCALO PVC ZCL2	11	348

NUMÉRICO

Código	Descripción	Pág.	Código	Descripción	Pág.	Código	Descripción	Pág.
00001	GRUPILLA MULETILLA PRESION 10014 NE	52	00855	CUADRADILLO EXPANSION CDD3 8x55mm ZN	114	05657	JGO MANILLA L RECTA 565 BL	8
00076	PLACA CLAVO P/IMAN IM24 15mm ZN	254	00868	JGO ROSETA CUADRADA 868 CN	38	05751	JGO ROSETA L CURVA 575 PVD	9
00077	PLACA ADHESIVA P/IMAN IM25 15mm NI	254	00878	JGO ROSETA CUADRADA 878 NS	38	05752	JGO ROSETA L CURVA 575 NE	9
00078	PLACA ATORNILLAR P/IMAN IM26 15mm ZN	254	00888	CUADRADILLO CDD1 9x120mm BC	114	05753	JGO ROSETA L CURVA 575 BL	9
00079	PLACA EMBUTIR P/IMAN IM27 10mm NI	254	00889	CUADRADILLO CDD1 8x80mm ZN	114	05754	JGO MANILLA L CURVA 575 IN	9
00086	REDUCTOR CUADRADILLO CDD7 8-6mm ZN	115	00890	CUADRADILLO CDD1 8x90mm ZN	114	05755	JGO MANILLA L CURVA 575 PVD	9
00087	REDUCTOR CUADRADILLO CDD8 8-7mm NE	115	00891	CUADRADILLO CDD1 8x100mm ZN	114	05756	JGO MANILLA L CURVA 575 NE	9
00088	REDUCTOR CUADRADILLO CDD8 7-6mm NE	115	00892	CUADRADILLO CDD1 8x120mm ZN	114	05757	JGO MANILLA L CURVA 575 BL	9
00089	REDUCTOR CUADRADILLO CDD8 9-8mm NE	115	00893	CUADRADILLO CDD1 8x150mm ZN	114	05758	MANILLON PLACA 585 IN	10
00100	JGO TORNILLO UNION KOMBY TNE4 M6 LTD	281	00894	VARILLA CUADRADILLO CDD4 8x1mt ZN	114	05759	MANILLON PLACA 585 PVD	10
00101	JGO TORNILLO UNION KOMBY TNE4 M6 NI	281	00901	JGO ROSETA CUADRADA 090 NM	34	05760	MANILLON PLACA 585 NE	10
00131	JGO ROSETA CUADRADA 131 IN	14	00902	JGO ROSETA CUADRADA 090 NN	34	05761	MANILLON PLACA 585 BL	10
00161	JGO ROSETA CUADRADA 161 IN	14	00959	JGO MANILLA 959 NS	33	05762	MANILLON POMO FIJO C/BOCALLAVE 585 IN	11
00191	JGO ROSETA CUADRADA 191 IN	14	00979	BOCALLAVE PERA 727 50mm LP	49	05763	MANILLON POMO FIJO C/BOCALLAVE 585 PVD	11
00206	JGO GANCHO CG1+PLACA COLGADOR CG2 ZN	322	00989	JGO MANILLA 989 NS	33	05764	MANILLON POMO FIJO C/BOCALLAVE 585 NE	11
00212	MANILLON ROSETA 727 LP	23	01001	JGO MANILLA 010 BI	27	05765	MANILLON POMO FIJO C/BOCALLAVE 585 BL	11
00231	JGO MANILLA BASCULANTE 231 NE	47	01002	JGO MANILLA 010 CU	27	05766	MANILLON ASA CORTA C/BOCALLAVE 585 IN	11
00232	JGO MANILLA P/METALICA 232 25-38mm NE	47	01003	JGO MANILLA 010 NS	27	05767	MANILLON ASA CORTA C/BOCALLAVE 585 PVD	11
00233	JGO MANILLA P/METALICA 232 25-38mm CB	47	01011	JGO ROSETA 101 NS	40	05768	MANILLON ASA CORTA C/BOCALLAVE 585 NE	11
00234	JGO MANILLA C/BOCALLAVE 704 NE	46	01012	JGO ROSETA 101 LTD	40	05769	MANILLON ASA CORTA C/BOCALLAVE 585 BL	11
00235	JGO MANILLA CIEGA 704 NE	46	01646	JGO MANILLA 1646 LTD	32	05851	JGO ROSETA U 585 PVD	10
00236	JGO MANILLA C/POMO 704 NE	46	01647	JGO MANILLA 1646 CU	32	05852	JGO ROSETA U 585 NE	10
00237	JGO MANILLA 703 ALUM PL	47	01666	JGO MANILLA 1666 LTD	31	05853	JGO ROSETA U 585 BL	10
00238	JGO MANILLA 703 ALUM OR	47	01777	JGO MANILLA 1777 LTD	29	05854	JGO MANILLA U 585 IN	10
00239	JGO MANILLA P/METALICA 232 35-50mm NE	47	01811	JGO MANILLA S/PLACA 181 LTD	43	05855	JGO MANILLA U 585 PVD	10
00240	JGO MANILLA P/METALICA 232 45-60mm NE	47	01812	JGO MANILLA S/PLACA 181 NS	43	05856	JGO MANILLA U 585 NE	10
00242	JGO MANILLA 242 NE	17	01813	JGO MANILLA S/PLACA 181 CB	43	05857	JGO MANILLA U 585 BL	10
00252	JGO MANILLA 252 NE	19	01814	JGO MANILLA S/PLACA 181 NE	43	06061	JGO ROSETA 606 LS	37
00272	JGO MANILLA 272 NE	16	01815	JGO MANILLA S/PLACA 181 BL	43	06062	JGO ROSETA 606 NS	37
00282	JGO MANILLA 282 NE	18	02001	JGO ROSETA 020 NE	19	06063	JGO ROSETA 606 CN	37
00292	JGO MANILLA 292 NE	18	02021	JGO MANILLA 202 LTD	26	06064	JGO MANILLA 606 LS	37
00343	JGO MANILLA 343 LP	22	02022	JGO MANILLA 202 BI	26	06065	JGO MANILLA 606 NS	37
00420	TORNILLO DOWELL TRN9 M4x20mm ZN	282	02023	JGO MANILLA 202 NS	26	06066	JGO MANILLA 606 CU	37
00421	TORNILLO DOWELL TRN9 M4x30mm ZN	282	02024	JGO MANILLA 202 CU	26	06067	JGO ROSETA 606 CU	37
00422	TORNILLO DOWELL TRN9 M6x40mm ZN	282	02025	MANILLON PLACA 202 LTD	26	06068	JGO ROSETA 606 NE	37
00423	TORNILLO DOWELL TRN9 M6x60mm ZN	282	02026	MANILLON PLACA 202 BI	26	06161	JGO ROSETA CUADRADA 616 LS	38
00425	TORNILLO DOWELL TRN9 M8x60mm ZN	282	02027	MANILLON PLACA 202 NS	26	06162	JGO ROSETA CUADRADA 616 NS	38
00426	TORNILLO DOWELL TRN9 M8x70mm ZN	282	02028	MANILLON PLACA 202 CU	26	06163	JGO ROSETA CUADRADA 616 CN	38
00427	TORNILLO DOWELL TRN9 M8x80mm ZN	282	02029	JGO ROSETA 202 LTD	26	06164	JGO ROSETA CUADRADA 616 CU	38
00428	TORNILLO DOWELL TRN9 M8x100mm ZN	282	02030	JGO ROSETA 202 BI	26	06861	JGO ROSETA PORCELANA 686 LE	20
00429	TORNILLO DOWELL TRN9 M10x50mm ZN	282	02031	JGO ROSETA 202 NS	26	07071	JGO ROSETA 707 LS	36
00430	TORNILLO DOWELL TRN9 M10x60mm ZN	282	02032	JGO ROSETA 202 CU	26	07072	JGO ROSETA 707 NS	36
00431	TORNILLO DOWELL TRN9 M10x90mm ZN	282	02033	JGO MANILLA 202 NE	26	07073	JGO MANILLA 707 LS	36
00432	TORNILLO DOWELL TRN9 M10x100mm ZN	282	02034	JGO ROSETA 202 NE	26	07074	JGO MANILLA 707 NS	36
00433	ESPARRAGO R/MADERA TRN13 8x60mm ZN	283	02035	MANILLON PLACA 202 NE	26	07075	JGO ROSETA 707 CB	36
00434	ESPARRAGO R/MADERA TRN13 8x70mm ZN	283	02122	MANILLON ROSETA 727 NS	23	07077	JGO ROSETA 707 NE	36
00435	ESPARRAGO R/MADERA TRN13 8x75mm ZN	283	02131	JGO MANILLON HUESO MN9 200mm LTD	95	07078	JGO MANILLA PLACA ANCHA 707 LTD	36
00436	ESPARRAGO 2 ROSCAS TRN14 4x40mm ZN	283	02132	JGO MANILLON HUESO MN9 200mm LS	95	07079	JGO MANILLA PLACA ANCHA 707 NS	36
00438	TORNILLO CASCABEL TRN15 9x40mm BC	282	02133	JGO MANILLON HUESO MN9 200mm NS	95	07272	JGO MANILLA 727 NS	22
00439	TORNILLO CASCABEL TRN15 9x60mm BC	282	02134	JGO MANILLON HUESO MN9 200mm CU	95	07273	JGO ROSETA 727 LP	22
00440	TORNILLO CASCABEL TRN15 9x80mm BC	282	02135	JGO MANILLON HUESO MN9 200mm CB	95	07275	JGO ROSETA 727 NS	22
00441	TORNILLO CASCABEL TRN15 9x100mm BC	282	02136	JGO MANILLON HUESO MN9 200mm NE	95	07871	JGO MANILLA PORCELANA 787 LE	21
00442	TORNILLO CAMA TRN12 9x60mm BC	292	02421	JGO MANILLA S/PLACA 242 NE	17	07872	JGO MANILLA PORCELANA 787 CU	21
00443	TORNILLO CAMA TRN12 9x80mm BC	292	02721	JGO MANILLA S/PLACA 272 NE	16	07873	JGO ROSETA PORCELANA 787 LE	21
00444	TORNILLO CAMA TRN12 9x100mm BC	292	02821	JGO MANILLA S/PLACA 282 NE	18	07874	JGO ROSETA PORCELANA 787 CU	21
00445	TUERCA RECTANGULAR TRC10 9x16mm BC	292	02921	JGO MANILLA S/PLACA 292 NE	18	07876	JGO ROSETA PORCELANA 787 PE*	21
00456	BL PERFIL PROTECTOR CANTOS S11 2mts BL	398	03031	JGO ROSETA 303 NS	41	07971	JGO MANILLA 797 LTD	27
00457	BL PERFIL PROTECTOR CANTOS S11 2mts MA	398	03032	JGO ROSETA 303 LTD	41	07972	JGO MANILLA 797 NS	27
00458	BL PERFIL PROTECTOR CANTOS C/ESQ S12 2mts BL	398	03131	JGO ROSETA 313 NS	41	07973	MANILLON PLACA 797 LTD	27
00459	BL PERFIL PROTECTOR CANTOS C/ESQ S12 2mts MA	398	03271	JGO MANILLA 327 NS	32	07974	MANILLON PLACA 797 NS	27
00460	BL PROTECTOR ESQUINA S13 60x60mm BL	398	03272	JGO ROSETA 327 NS	32	08103	CUADRADILLO RANURADO CDD2 8x80mm ZN	114
00461	BL PROTECTOR ESQUINA S13 60x60mm MA	398	03432	JGO MANILLA 343 NS	22	08104	CUADRADILLO RANURADO CDD2 8x90mm ZN	114
00462	BL PROTECTOR ESQUINA S14 42mm TR	399	03531	JGO ROSETA 353 CN	41	08105	CUADRADILLO RANURADO CDD2 8x100mm ZN	114
00463	BL PROTECTOR ESQUINA S15 40x40mm TR	399	03631	JGO ROSETA 363 CN	35	08481	JGO ROSETA CUADRADA 848 NN	34
00464	BL CIERRE SEGURIDAD S16 145mm BL	399	03731	JGO ROSETA 373 CN	42	08482	JGO ROSETA CUADRADA 848 NS	34
00465	BL CIERRE SEGURIDAD S16 165mm BL	399	03831	JGO ROSETA 383 NS	41	08981	JGO ROSETA 898 NN	34
00466	BL CIERRE SEGURIDAD REGULABLE S17 BL	399	03832	JGO ROSETA 383 LTD	41	08982	JGO ROSETA 898 NN	34
00467	BL PROTECTOR TIRADOR ARMARIO S18 185x45mm BL	400	03931	JGO ROSETA 393 NS	40	09091	JGO ROSETA 909 LS	42
00468	BL PROTECTOR ARMARIO S19 95mm BL	400	04041	JGO ROSETA 404 LS	42	09092	JGO ROSETA 909 NS	42
00469	BL PROTECTOR CAJONES S110 70x40mm BL/AZ	400	04042	JGO ROSETA 404 NS	42	09192	JGO MANILLA 919 CU	25
00470	BL TOPE SALVA DEDOS S111 20mm BL	400	04241	JGO ROSETA CUADRADA 424 NS	39	09193	JGO MANILLA 919 NS	25
00471	BL PROTECTOR ENCHUFE GIRATORIO S112 BL	401	04341	JGO ROSETA CUADRADA 434 NS	39	09195	JGO ROSETA 919 CU	25
00472	BL PROTECTOR ENCHUFE FIJO S113 BL	401	04541	JGO ROSETA 454 NS	40	09196	JGO ROSETA 919 NS	25
00473	BL TOPE PUERTA CUÑA S115 BL	401	04641	JGO ROSETA CUADRADA 464 NS	39	09491	JGO ROSETA 949 CB	35
00474	BL SEGURO VENTANA CORREDERA S114 LT	401	04642	JGO ROSETA 464 NS	40	09591	JGO ROSETA 959 NS	33
00475	TORNILLO CAMA TRN12 9x140mm BC	292	04741	JGO ROSETA 474 NS	35	09691	JGO ROSETA CUADRADA 969 NN	34
00476	TORNILLO CASCABEL TRN15 9x120mm BC	282	04841	JGO ROSETA 484 NS	42	09692	JGO ROSETA CUADRADA 969 NN	34
00477	TORNILLO CASCABEL TRN15 9x140mm BC	282	04842	JGO ROSETA 484 LTD	42	09792	BOCALLAVE PERA 727 50mm NS	49
00505	JGO MANILLA 505 BI	24	04941	JGO ROSETA 494 NS	35	09793	BOCALLAVE PERA 575 53mm IN	48
00515	JGO ROSETA 515 IN	12	04942	JGO ROSETA 494 LTD	35	09795	BOCALLAVE PERA 727 50mm CU	49
00545	JGO ROSETA 545 IN	12	04943	JGO ROSETA 494 CU	35	10001	POMO PUERTA BOLA PP5 70mm IN	93
00565	JGO ROSETA L RECTA 565 IN	8	05051	JGO MANILLA 505 CU	24	10002	POMO PUERTA AROS PP1 70mm NS	92
00575	JGO ROSETA L CURVA 575 IN	9	05052	MANILLON ASA CORTA 505 BI	25	10003	POMO PUERTA BOLA PP5 60mm IN	93
00585	JGO ROSETA U 585 IN	10	05053	MANILLON POMO FIJO 505 BI	25	10006	MANILLON TORNEADO MN4 300mm LP	94
00595	JGO ROSETA 595 IN	13	05054	MANILLON ASA CORTA 505 LP	25	10007	MANILLON TORNEADO MN4 400mm LP	94
00636	JGO ROSETA 636 IN	13	05055	MANILLON POMO FIJO 505 LP	25	10008	POMO PUERTA AROS PP1 70mm LP	92
00656	JGO ROSETA CUADRADA 656 IN	15	05056	MANILLON ASA CORTA 505 NS	25	10009	POMO PUERTA LISO PP2 70mm LP	93
00666	JGO MANILLA 666 LP	30	05057	MANILLON POMO FIJO 505 NS	25	10010	POMO PUERTA BOLA PP4 75mm LP	93
00670	TORNILLO DOWELL TRN9 M6x70mm ZN	282	05151	JGO ROSETA 515 PVD	12	10011	POMO PUERTA OCTOGONAL PP3 65mm LP	92
00676	JGO ROSETA CUADRADA 676 IN	14	05152	JGO ROSETA 515 NE	12	10012	EMBELLECEDOR MIRILLA MR3 45mm LP	97
00686	JGO MANILLA PORCELANA 686 LE	20	05153	JGO ROSETA 515 BL	12	10013	MIRILLA 14mm 180° MR1 35/60mm LTD	96
00689	CUADRADILLO CDD1 6x80mm ZN	114	05154	JGO MANILLA 515 IN	12	10014	MULETILLA MANILLA 10014 LP	52
00690	CUADRADILLO CDD1 6x90mm ZN	114	05155	JGO MANILLA 515 PVD	12	10016	TOPE PUERTA SETA TP4 20mm LTD	126
00691	CUADRADILLO CDD1 6x100mm ZN	114	05156	JGO MANILLA 515 NE	12	10017	TOPE PUERTA SETA TP4 20mm NS	126
00692	VARILLA CUADRADILLO CDD4 6x1mt ZN	114	05157	JGO MANILLA 515 BL	12	10018	LLAMADOR INGRES LLM1 200x90mm LP	92
00717	JGO ROSETA 717 IN	15	05651	JGO ROSETA L RECTA 565 PVD	8	10019	TOPE PUERTA SETA TP3 20mm LP	126
00727	JGO MANILLA 727 LP	22	05652	JGO ROSETA L RECTA 565 NE	8	10020	TOPE PUERTA LUX TALADRO TP1 OR	125
00737	JGO ROSETA 737 IN	12	05653	JGO ROSETA L RECTA 565 BL	8	10023	TIRADOR ARMARIO S/B 727 LP	23
00747	JGO ROSETA 747 IN	13	05654	JGO MANILLA L RECTA 565 IN	8	10025	TIRADOR MALETERO 727 LP	23
00767	JGO ROSETA 767 IN	15	05655	JGO MANILLA L RECTA 565 PVD	8	10033	TIRADOR ARMARIO S/B 727 NS	23
00777	JGO MANILLA 777 LP	28	05656	JGO MANILLA L RECTA 565 NE	8	10035	TIRADOR MALETERO 727 NS	23

NUMÉRICO

Código	Descripción	Pág.	Código	Descripción	Pág.	Código	Descripción	Pág.
10038	ASA ABATIBLE LISA TRM12 100x27mm NE	205	10229	TOPE PUERTA CLASICO TP9 BL	124	10355	BL LETRA LATON P LTR1 100mm NE	143
10039	ASA ABATIBLE LISA TRM12 125x27mm NE	205	10230	TOPE PUERTA CLASICO TP9 MA	124	10356	BL LETRA LATON Q LTR1 100mm NE	143
10040	ESCUDO TAPAPOMO REDONDO ES4 60mm LP	116	10231	TOPE PUERTA LUX ADHESIVO TP2 SAPELI*	125	10357	BL LETRA LATON R LTR1 100mm NE	143
10041	ASA ABATIBLE LISA TRM12 100x27mm ZN	205	10232	TOPE PUERTA STOP ADHESIVO TP11 IN	127	10358	BL LETRA LATON S LTR1 100mm NE	143
10042	ASA ABATIBLE LISA TRM12 125x27mm ZN	205	10235	TOPE PUERTA SETA TP6 32mm GR	126	10359	BL LETRA LATON T LTR1 100mm NE	143
10043	ASA ABATIBLE LISA TRM12 100x27mm BC	205	10236	TOPE PUERTA LUX ADHESIVO TP7 47mm GR	125	10360	BL LETRA LATON U LTR1 100mm NE	143
10044	ASA ABATIBLE LISA TRM12 125x27mm BC	205	10237	TOPE PUERTA RETENEDOR TP12 IN	124	10361	BL LETRA LATON V LTR1 100mm NE	143
10047	ASA ABATIBLE REFORZADA TRM13 110mm ZN	205	10238	TORNILLO PRISIONERO MANILLA TRN4 M5x6mm IN	117	10362	BL LETRA LATON W LTR1 100mm NE	143
10064	REMATE BOLA PMN5 43x65x31mm LP	140	10239	POMO PUERTA LISO PP2 70mm NS	93	10363	BL LETRA LATON X LTR1 100mm NE	143
10065	REMATE BOLA PMN5 58x100x35mm LP	140	10240	POMO PUERTA LISO PP2 70mm CU	93	10364	BL LETRA LATON Y LTR1 100mm NE	143
10066	REMATE BOLA PMN5 70x120x40mm LP	140	10241	ESCUDO TAPAPOMO REDONDO ES4 60mm NS	116	10365	BL LETRA LATON Z LTR1 100mm NE	143
10067	SOPORTE PASAMANOS TORNILLOS PMN1 LP	139	10242	EMBELLECEDOR MIRILLA MR3 45mm NS	97	10366	BL LETRA LATON I LTR1 100mm NS	143
10069	REMATE BELLOTA PMN6 60x110x35mm LP	140	10244	CIERRE BOLA IM6 44mm LT	248	10367	BL LETRA LATON J LTR1 100mm NS	143
10079	BL CORBATERO VARILLA IA8 250mm OR	225	10245	CIERRE BOLA IM6 44mm NS	248	10368	BL LETRA LATON K LTR1 100mm NS	143
10080	BL CORBATERO VARILLA IA8 300mm OR	225	10246	CIERRE BOLA IM6 50mm NS	248	10369	BL LETRA LATON L LTR1 100mm NS	143
10081	BL CORBATERO VARILLA IA8 350mm OR	225	10247	CIERRE BOLA IM6 70mm NS	248	10370	BL LETRA LATON M LTR1 100mm NS	143
10082	BL CORBATERO VARILLA IA8 400mm OR	225	10249	POMO PUERTA BOLA PP4 75mm NS	93	10371	BL LETRA LATON N LTR1 100mm NS	143
10083	BL CORBATERO VARILLA IA8 450mm OR	225	10250	CIERRE BOLA IM6 50mm LT	248	10372	BL LETRA LATON O LTR1 100mm NS	143
10084	BL CORBATERO VARILLA IA8 500mm OR	225	10251	SOPORTE PASAMANOS TORNILLOS PMN1 NS	139	10373	BL LETRA LATON P LTR1 100mm NS	143
10089	CIERRE 2 RODILLOS GOMA IM1 1mm BC	248	10252	SOPORTE PASAMANOS TORNILLOS PMN1 NE	139	10374	BL LETRA LATON Q LTR1 100mm NS	143
10092	BISAGRA CAZOLETA SOBREPONER BC10 ZN	196	10253	SOPORTE PASAMANOS DOWELL PMN2 NS	139	10375	BL LETRA LATON R LTR1 100mm NS	143
10096	MULETILLA ROSETA 727 35mm LP	50	10254	SOPORTE PASAMANOS DOWELL PMN2 NE	139	10376	BL LETRA LATON S LTR1 100mm NS	143
10097	MULETILLA MINUSVALIDO CB11 50mm IN	152	10255	TORNILLO PRISIONERO MANILLA TRN4 M6x6mm IN	117	10377	BL LETRA LATON T LTR1 100mm NS	143
10098	MULETILLA MANILLA C/DESBLOQUEO 10098 LP	52	10260	BL NUMERO LATON 0 NM1 100mm LP	142	10378	BL LETRA LATON U LTR1 100mm NS	143
10100	PICAPORTE CONDENA C/R PCT1 47mm LTD	168	10261	BL NUMERO LATON 1 NM1 100mm LP	142	10379	BL LETRA LATON V LTR1 100mm NS	143
10101	PICAPORTE CONDENA C/R PCT1 47mm NS	168	10262	BL NUMERO LATON 2 NM1 100mm LP	142	10380	BL LETRA LATON W LTR1 100mm NS	143
10102	PICAPORTE CONDENA C/R PCT1 47mm NE	168	10263	BL NUMERO LATON 3 NM1 100mm LP	142	10381	BL LETRA LATON X LTR1 100mm NS	143
10103	PICAPORTE CONDENA C/R PCT1 47mm CU	168	10264	BL NUMERO LATON 4 NM1 100mm LP	142	10382	BL LETRA LATON Y LTR1 100mm NS	143
10106	CERRADERO PICAPORTE CONDENA PCT1 LTD	169	10265	BL NUMERO LATON 5 NM1 100mm LP	142	10383	BL LETRA LATON Z LTR1 100mm NS	143
10107	CERRADERO PICAPORTE CONDENA PCT1 NS	169	10266	BL NUMERO LATON 6-9 NM1 100mm LP	142	10384	NEODIMIO DISCO IM28 5x3mm NI	255
10108	CERRADERO PICAPORTE TUBULAR PCT3 LTD	169	10267	BL NUMERO LATON 7 NM1 100mm LP	142	10385	NEODIMIO DISCO IM28 9,5x1,5mm NI	255
10109	CERRADERO PICAPORTE TUBULAR PCT3 NS	169	10268	BL NUMERO LATON 8 NM1 100mm LP	142	10386	NEODIMIO DISCO IM28 10x3mm NI	255
10110	POMO PUERTA MARGARITA PP6 75mm CU	93	10270	CIERRE BOLA IM6 70mm LT	248	10387	NEODIMIO DISCO IM28 14x4mm NI	255
10111	PICAPORTE TUBULAR C/C PCT3 35mm LTD	169	10271	BL LETRA LATON A LTR1 100mm LP	142	10388	NEODIMIO DISCO IM28 20x5mm NI	255
10112	PICAPORTE TUBULAR C/C PCT3 35mm NS	169	10272	BL LETRA LATON B LTR1 100mm LP	142	10389	NEODIMIO DISCO IM28 22x10mm NI	255
10114	PICAPORTE TUBULAR C/R PCT3 45mm LTD	169	10273	BL LETRA LATON C LTR1 100mm LP	142	10390	NEODIMIO DISCO IM28 28x10mm NI	255
10115	PICAPORTE TUBULAR C/R PCT3 45mm NS	169	10274	BL LETRA LATON D LTR1 100mm LP	142	10391	NEODIMIO DISCO IM28 40x20mm NI	255
10116	PICAPORTE TUBULAR C/R PCT3 45mm LTD	169	10275	BL LETRA LATON E LTR1 100mm LP	142	10392	NEODIMIO DISCO IM28 50x25mm NI	255
10117	PICAPORTE TUBULAR C/R PCT3 45mm NS	169	10276	BL LETRA LATON F LTR1 100mm LP	142	10393	NEODIMIO DISCO IM28 60x30mm NI	255
10119	PICAPORTE TUBULAR C/C PCT3 60mm LTD	169	10277	BL LETRA LATON G LTR1 100mm LP	142	10394	NEODIMIO DISCO ADH IM29 9,5x1,5mm NI	254
10120	PICAPORTE TUBULAR C/C PCT3 60mm NS	169	10278	BL LETRA LATON H LTR1 100mm LP	142	10395	NEODIMIO DISCO ADH IM29 12,5x1,5mm NI	254
10121	PICAPORTE TUBULAR C/C PCT3 70mm LTD	169	10280	BL NUMERO LATON 0 NM1 100mm NE	142	10396	NEODIMIO BLOQUE IM30 20x10x5mm NI	255
10122	PICAPORTE TUBULAR C/C PCT3 70mm NS	169	10281	BL NUMERO LATON 1 NM1 100mm NE	142	10398	NEODIMIO BLOQUE IM30 30x9x2mm NI	255
10123	EMBELLECEDOR MIRILLA MR3 45mm CU	97	10282	BL NUMERO LATON 2 NM1 100mm NE	142	10399	NEODIMIO BLOQUE IM30 30x10x5mm NI	255
10124	EMBELLECEDOR MIRILLA MR3 45mm NE	97	10283	BL NUMERO LATON 3 NM1 100mm NE	142	10400	NEODIMIO BLOQUE IM30 40x20x5mm NI	255
10125	PICAPORTE RODILLO PCT5 80x18mm BC	170	10284	BL NUMERO LATON 4 NM1 100mm NE	142	10401	NEODIMIO BLOQUE IM30 40x20x10mm NI	255
10126	PICAPORTE RODILLO PCT5 100x21mm BC	170	10285	BL NUMERO LATON 5 NM1 100mm NE	142	10402	ESCUDO TAPAPOMO CUADRADO ES5 60mm LP	116
10127	PICAPORTE RODILLO PCT5 120x23mm BC	170	10286	BL NUMERO LATON 6-9 NM1 100mm NE	142	10403	ESCUDO TAPAPOMO CUADRADO ES5 60mm NS	116
10128	PICAPORTE VAIVEN PCT6 60x15mm BC	170	10287	BL NUMERO LATON 7 NM1 100mm NE	142	10404	NEODIMIO ARO AVELLANADO IM31 10x3mm (8-4) NI	256
10129	PICAPORTE VAIVEN PCT6 80x18mm BC	170	10288	BL NUMERO LATON 8 NM1 100mm NE	142	10405	NEODIMIO ARO AVELLANADO IM31 20x3mm (8-4) NI	256
10130	MIRILLA 14mm 180° MR1 60/100mm NS	96	10291	BL LETRA LATON A LTR1 100mm NE	143	10406	NEODIMIO ARO AVELLANADO IM31 18x4mm (8-4) NI	256
10131	MIRILLA 14mm 180° MR1 15/25mm LTD	96	10292	BL LETRA LATON B LTR1 100mm NE	143	10407	IMAN PETAÑCA NEODIMIO IM33 NE	257
10132	MIRILLA 14mm 180° MR1 25/42mm LTD	96	10293	BL LETRA LATON C LTR1 100mm NE	143	10408	NEODIMIO GANCHO IM32 16x9,5mm NI	256
10134	MIRILLA 14mm 180° MR1 35/60mm NS	96	10294	BL LETRA LATON D LTR1 100mm NE	143	10409	NEODIMIO GANCHO IM32 20x14mm NI	256
10136	MIRILLA 14mm 180° MR1 25/42mm NS	96	10295	BL LETRA LATON E LTR1 100mm NE	143	10410	NEODIMIO GANCHO IM32 25x20mm NI	256
10137	MIRILLA 14mm 180° MR1 35/60mm CU	96	10296	BL LETRA LATON F LTR1 100mm NE	143	10411	FERRITA DISCO IM34 12x2,5mm NE	257
10138	MIRILLA 14mm 180° MR1 60/100mm LTD	96	10297	BL LETRA LATON G LTR1 100mm NE	143	10413	FERRITA DISCO IM34 22x3mm NE	257
10139	MIRILLA 14mm 180° MR1 15/25mm NS	96	10298	BL LETRA LATON H LTR1 100mm NE	143	10414	FERRITA DISCO IM34 25x5mm NE	257
10142	PICAPORTE VAIVEN PCT6 100x21mm BC	170	10300	BL NUMERO LATON 0 NM1 100mm NS	142	10415	FERRITA BLOQUE IM35 20x10x15mm NE	257
10143	MULETILLA MANILLA 10014 NS	52	10301	BL NUMERO LATON 1 NM1 100mm NS	142	10416	FERRITA BLOQUE IM35 40x20x10mm NE	257
10145	CONDENA PICAPORTE TUBULAR PCT4 LTD	169	10302	BL NUMERO LATON 2 NM1 100mm NS	142	10418	NEODIMIO ARO AVELLANADO IM31 12x6mm (8-4) NI	256
10146	CONDENA PICAPORTE TUBULAR PCT4 NS	169	10303	BL NUMERO LATON 3 NM1 100mm NS	142	10419	NEODIMIO ARO AVELLANADO IM31 20x3mm (8-4) NI	256
10162	MANILLON TORNEADO MN5 140-230mm LP	94	10304	BL NUMERO LATON 4 NM1 100mm NS	142	10420	NEODIMIO ARO AVELLANADO IM31 25x5mm (6,7-3,1) NI	256
10163	MANILLON DESPLAZADO MN6 140-230mm LP	94	10305	BL NUMERO LATON 5 NM1 100mm NS	142	10421	NEODIMIO ARO AVELLANADO IM31 30x7mm (4,5-0,9) NI	256
10165	MIRILLA 16mm 180° MR2 35/60mm LTD	96	10306	BL NUMERO LATON 6-9 NM1 100mm NS	142	10422	BL PAPEL MAGNETICO FOTOS IM36 100x150mm	416
10166	MIRILLA 16mm 180° MR2 35/60mm NS	96	10307	BL NUMERO LATON 7 NM1 100mm NS	142	10423	BL PAPEL MAGNETICO FOTOS IM36 250x200mm	416
10167	MIRILLA DIGITAL MD1 ORO	97	10308	BL NUMERO LATON 8 NM1 100mm NS	142	10424	PORTAETIQUETAS MAGNETICO IM37 105x50mm NE	416
10168	MIRILLA DIGITAL MD1 PLATA	97	10311	BL LETRA LATON A LTR1 100mm NS	143	10425	NEODIMIO ARO AVELLANADO IM31 32x7mm (5,5-1,1) NI	256
10169	MANILLON TORNEADO MN7 300mm LP	94	10312	BL LETRA LATON B LTR1 100mm NS	143	10426	NEODIMIO ARO AVELLANADO IM31 35x7mm (4,5-0,9) NI	256
10170	PICAPORTE CONDENA C/R PCT2 70mm LTD	168	10313	BL LETRA LATON C LTR1 100mm NS	143	10620	MANILLON TORNEADO MN4 300mm NS	94
10171	PICAPORTE CONDENA C/R PCT2 70mm NS	168	10314	BL LETRA LATON D LTR1 100mm NS	143	10630	MANILLON TORNEADO MN4 300mm NE	94
10172	PICAPORTE CONDENA C/R PCT2 70mm NE	168	10315	BL LETRA LATON E LTR1 100mm NS	143	10661	SOPORTE PASAMANOS DOWELL PMN3 LTD	139
10178	MANILLON DESPLAZADO MN8 300mm LP	94	10316	BL LETRA LATON F LTR1 100mm NS	143	10662	SOPORTE PASAMANOS DOWELL PMN3 NE	139
10179	MANILLON TORNEADO MN5 230-300mm LP	94	10317	BL LETRA LATON G LTR1 100mm NS	143	10663	SOPORTE PASAMANOS DOWELL PMN3 NS	139
10180	MANILLON DESPLAZADO MN6 230-300mm LP	94	10318	BL LETRA LATON H LTR1 100mm NS	143	10664	SOPORTE PASAMANOS DOWELL PMN3 CU	139
10182	LLAMADOR INGLÉS LLM1 200x90mm NS	92	10330	BL LETRA LATON I LTR1 100mm LP	142	10665	SOPORTE PASAMANOS DOWELL PMN4 BC	140
10192	TOPE PUERTA SETA TP3 20mm CB	126	10331	BL LETRA LATON J LTR1 100mm LP	142	10671	SOPORTE PASAMANOS DOWELL PMN2 LP	139
10193	TOPE PUERTA SETA TP3 20mm NS	126	10332	BL LETRA LATON K LTR1 100mm LP	142	10792	BL CORBATERO VARILLA IA8 250mm NI	225
10196	TOPE PUERTA RETENEDOR TP8 90mm IN	124	10333	BL LETRA LATON L LTR1 100mm LP	142	10802	BL CORBATERO VARILLA IA8 300mm NI	225
10198	TOPE PUERTA SETA TP3 20mm IN	126	10334	BL LETRA LATON M LTR1 100mm LP	142	10803	PLACA IDENTIFICATIVA HOMBRE PLP6 75mm IN	141
10199	TOPE PUERTA SETA PARQUET TP5 20mm IN	126	10335	BL LETRA LATON N LTR1 100mm LP	142	10804	PLACA IDENTIFICATIVA MUJER PLP7 75mm IN	141
10200	POMO PUERTA MARGARITA PP6 75mm LP	93	10336	BL LETRA LATON O LTR1 100mm LP	142	10805	PLACA IDENTIFICATIVA TOILETTE PLP8 75mm IN	141
10201	TOPE PUERTA LUX TALADRO TP1 OM	125	10337	BL LETRA LATON P LTR1 100mm LP	142	10807	PLACA IDENTIFICATIVA MINIVULNEROS PLP9 75mm IN	141
10202	TOPE PUERTA LUX TALADRO TP1 CB	125	10338	BL LETRA LATON Q LTR1 100mm LP	142	10812	BL CORBATERO VARILLA IA8 350mm NI	225
10203	TOPE PUERTA LUX TALADRO TP1 NS	125	10339	BL LETRA LATON R LTR1 100mm LP	142	10822	BL CORBATERO VARILLA IA8 400mm NI	225
10204	TOPE PUERTA LUX TALADRO TP1 BL	125	10340	BL LETRA LATON S LTR1 100mm LP	142	10832	BL CORBATERO VARILLA IA8 450mm NI	225
10206	TOPE PUERTA LUX TALADRO TP1 CU*	125	10341	BL LETRA LATON T LTR1 100mm LP	142	10842	BL CORBATERO VARILLA IA8 500mm NI	225
10210	TOPE PUERTA LUX ADHESIVO TP2 OR*	125	10342	BL LETRA LATON U LTR1 100mm LP	142	10891	CIERRE 2 RODILLOS GOMA IM1 1mm ZN	248
10211	TOPE PUERTA LUX ADHESIVO TP2 OM*	125	10343	BL LETRA LATON V LTR1 100mm LP	142	10894	CIERRE 2 RODILLOS GOMA IM1 1mm CU	248
10213	TOPE PUERTA LUX ADHESIVO TP2 NS	125	10344	BL LETRA LATON W LTR1 100mm LP	142	10895	AMORTIGUADOR EMBUTIR IM13 BL	250
10219	TOPE PUERTA SETA TP6 32mm HAYA	126	10345	BL LETRA LATON X LTR1 100mm LP	142	10901	CIERRE MAGNETICO IM2 42mm BL	248
10220	TOPE PUERTA SETA TP6 32mm BL	126	10346	BL LETRA LATON Y LTR1 100mm LP	142	10902	CIERRE MAGNETICO IM2 42mm MA	248
10221	TOPE PUERTA SETA TP6 32mm SAPELI	126	10347	BL LETRA LATON Z LTR1 100mm LP	142	10903	CIERRE TOCA-TOCA IM4 35x28mm BL	249
10222	TOPE PUERTA SETA TP6 32mm RB	126	10348	BL LETRA LATON I LTR1 100mm NE	143	10904	CIERRE TOCA-TOCA IM4 35x28mm BL	249
10223	TOPE PUERTA LUX ADHESIVO TP7 47mm HAYA	125	10349	BL LETRA LATON J LTR1 100mm NE	143	10907	CIERRE MAGNETICO C/MUELLE IM3 BL	249

NUMÉRICO

Código	Descripción	Pág.	Código	Descripción	Pág.	Código	Descripción	Pág.
10915	EXPULSOR C/BASE IMAN IM9 40mm GR	252	11154	BL POMO PUERTA BOLA ENTRADA PP7 IN	44	13034	CILINDRO SEGURIDAD CS2 L15 35x35mm NI	106
10916	EXPULSOR C/BASE AMORTIGUADOR IM8 40mm GR	252	11155	BL POMO PUERTA BOLA BAÑO PP7 LP	44	13035	CILINDRO SEGURIDAD CS2 L15 30x50mm NI	106
10917	EXPULSOR EMBUTIR IMAN IM11 37mm GR	253	11156	BL POMO PUERTA BOLA BAÑO PP7 IN	44	13036	CILINDRO SEGURIDAD CS2 L15 30x40mm NI	106
10918	EXPULSOR EMBUTIR AMORTIGUADOR IM10 37mm GR	253	11157	BL POMO PUERTA BOLA HOTEL PP7 LP	45	13037	CILINDRO SEGURIDAD CS2 L15 40x40mm LT	106
10919	AMORTIGUADOR GUIA GC15 224mm GR	212	11158	BL POMO PUERTA BOLA HOTEL PP7 IN	45	13038	CILINDRO SEGURIDAD CS2 L15 40x40mm NI	106
10921	EXPULSOR EMBUTIR IMAN IM11 16mm GR	253	11159	BL POMO PUERTA BOLA PASO PP7 LP	45	13039	CILINDRO SEGURIDAD CS2 L15 30x50mm LT	106
10922	EXPULSOR EMBUTIR AMORTIGUADOR IM10 16mm GR	253	11160	BL POMO PUERTA BOLA PASO PP7 IN	45	13040	CILINDRO SEGURIDAD CS2 L15 30x50mm NI	106
10923	EXPULSOR EMBUTIR IMAN REG IM12 17mm GR	253	11161	BL POMO PUERTA BOLA ENTRADA PP7 BL	44	13041	CILINDRO SEGURIDAD CS2 L15 40x50mm LT	106
10924	EXPULSOR EMBUTIR AMORTIGUADOR REG IM38 17mm GR	253	11162	BL POMO PUERTA BOLA BAÑO PP7 BL	44	13042	CILINDRO SEGURIDAD CS2 L15 40x50mm NI	106
10925	IMAN PIZARRA IM7 25mm BLANCO	249	11163	BL POMO PUERTA BOLA HOTEL PP7 BL	45	13043	CILINDRO SEGURIDAD CS2 L13 30x10mm NI	107
10926	IMAN PIZARRA IM7 25mm MARRON	249	11164	BL POMO PUERTA BOLA PASO PP7 BL	45	13044	CILINDRO SEGURIDAD CS2 L13 40x10mm NI	107
10927	IMAN PIZARRA IM7 25mm NEGRO	249	11165	LLAVE BRUTO POMO PUERTA BOLA PP7 NI	45	13045	CILINDRO SEGURIDAD CS2 L13 30x30mm NI	107
10928	IMAN PIZARRA IM7 25mm ROJO	249	11166	CERRADURA ARMARIO CM9 22mm CB	240	13046	CILINDRO SEGURIDAD CS2 L13 35x35mm NI	107
10929	IMAN PIZARRA IM7 25mm AMARILLO	249	11167	CERRADURA ARCHIVADOR CM10 18mm CB	243	13047	CILINDRO SEGURIDAD CS2 L13 30x40mm NI	107
10930	IMAN PIZARRA IM7 25mm AZUL	249	11168	CERRADURA ARCHIVADOR LLI/ CM10 18mm CB	243	13048	CILINDRO SEGURIDAD CS2 L13 40x40mm NI	107
10931	IMAN PIZARRA IM7 25mm SURTIDO	249	11169	CERRADURA BUZON RECTA LLI/ CM4 30mm CB	245	13049	CILINDRO SERRETA CS3 L15 30x30mm LT	108
10932	CIERRE MAGNETICO REG IM5 30x30mm BL	249	11170	CERRADURA ARMARIO LLI/ CM9 22mm CB	240	13050	CILINDRO SERRETA CS3 L15 30x30mm NI	108
10933	CIERRE MAGNETICO REG IM5 30x30mm MA	249	11171	CERRADURA TAQUILLA CM14 26mm MK1 CB	241	13051	CILINDRO SERRETA CS3 L15 35x35mm LT	108
10934	CIERRE MAGNETICO REG IM5 30x30mm NE	249	11172	CERRADURA TAQUILLA CM14 26mm MK2 CB	241	13052	CILINDRO SERRETA CS3 L15 35x35mm NI	108
10935	TOPE EMBUTIR AMORTIGUADOR IM14 GR	250	11173	CERRADURA TAQUILLA CM14 26mm MK3 CB	241	13053	CILINDRO SERRETA CS3 L15 30x40mm LT	108
10936	TOPE EMBUTIR IMAN IM15 GR	250	11174	LLAVE CERRADURA TAQUILLA CM14 MK1 VERDE	241	13054	CILINDRO SERRETA CS3 L15 30x40mm NI	108
10937	TOPE EMBUTIR AMORTIGUADOR REGULABLE IM16 GR	250	11175	LLAVE CERRADURA TAQUILLA CM14 MK2 VERDE	241	13055	CILINDRO SERRETA CS3 L15 40x40mm LT	108
10938	TOPE EMBUTIR IMAN REGULABLE IM17 GR	250	11176	LLAVE CERRADURA TAQUILLA CM14 MK3 VERDE	241	13056	CILINDRO SERRETA CS3 L15 40x40mm NI	108
10939	TOPE ALAS AMORTIGUADOR IM20 GR	251	11177	LLAVE MASTER CERRADURA TAQUILLA CM14 MK1-2-3 AZUL	241	13057	CILINDRO SERRETA CS3 L15 30x50mm LT	108
10940	TOPE ALAS IMAN IM21 GR	251	11178	CERRADURA COMBINACION TAQUILLA CM13 CB	245	13058	CILINDRO SERRETA CS3 L15 30x50mm NI	108
10941	TOPE C/BASE AMORTIGUADOR IM18 GR	251	11179	CERRADURA COMBINACION TAQUILLA CM13 NE	245	13059	CILINDRO SERRETA CS3 L15 40x50mm LT	108
10942	TOPE C/BASE IMAN IM19 GR	251	11180	CERRADURA SOBREPONER CM17 22mm LTD	242	13060	CILINDRO SERRETA CS3 L15 40x50mm NI	108
10943	EXPULSOR C/BASE IMAN IM22 GR	252	11181	LLAMADOR INGLES LLM1 200x90mm NE	92	13061	CILINDRO SERRETA CS3 L13 30x10mm NI	110
10944	EXPULSOR C/BASE AMORTIGUADOR IM23 GR	252	11182	CERRADURA EMBUTIR CM15 15mm LP	242	13062	CILINDRO SERRETA CS3 L13 40x10mm NI	110
10952	MULETILLA ROSETA 727 50mm NS	50	11183	CERRADURA EMBUTIR CM15 20mm LP	242	13063	CILINDRO SERRETA CS3 L13 30x30mm NI	110
10953	MULETILLA ROSETA 727 53mm IN	50	11184	CERRADURA EMBUTIR CM15 25mm LP	242	13064	CILINDRO SERRETA CS3 L13 35x35mm NI	110
10957	MULETILLA ROSETA C/LLAVE C/R 1095 50mm NS	52	11185	CERRADURA EMBUTIR CM15 30mm LP	242	13065	CILINDRO SERRETA CS3 L13 30x40mm NI	110
10958	MULETILLA ROSETA C/LLAVE C/C 1095 50mm NS	52	11186	CERRADURA EMBUTIR CM15 35mm LP	242	13066	CILINDRO SERRETA CS3 L13 40x40mm NI	110
10959	MULETILLA ROSETA C/LLAVE C/R 1095 50mm LTD	52	11187	CERRADURA EMBUTIR CM15 40mm LP	242	13067	LLAVE BRUTO CILINDRO SEGURIDAD CS2 NI	112
10960	MULETILLA ROSETA C/LLAVE C/C 1095 50mm LTD	52	11188	CERRADURA SOBREPONER CM16 20mm LTD	242	13068	LLAVE BRUTO CILINDRO SERRETA CS3 NI	112
10961	MULETILLA ROSETA 727 35mm NS	50	11189	CERRADURA SOBREPONER CM16 25mm LTD	242	13069	CILINDRO SERRETA CS3 LLI/ L15 30x30mm LT	108
10962	MULETILLA ROSETA 727 35mm IN	50	11190	CERRADURA SOBREPONER CM16 30mm LTD	242	13070	CILINDRO SERRETA CS3 LLI/ L15 30x30mm NI	108
10963	MULETILLA ROSETA 727 35mm CU	50	11191	CERRADURA SOBREPONER CM16 35mm LTD	242	13071	CILINDRO SERRETA CS3 LLI/ L15 35x35mm LT	108
10966	MULETILLA ROSETA 545 54mm IN	50	11192	CERRADURA SOBREPONER CM16 40mm LTD	242	13072	CILINDRO SERRETA CS3 LLI/ L15 35x35mm NI	108
10967	MULETILLA ROSETA 575 35mm PVD	50	11193	CERRADURA FALLEBA CM18 18,5mm BL	242	13073	CILINDRO SERRETA CS3 LLI/ L15 30x40mm LT	108
10968	MULETILLA ROSETA 575 35mm NE	50	11194	CERRADURA FALLEBA CM18 18,5mm MA	242	13074	CILINDRO SERRETA CS3 LLI/ L15 30x40mm NI	108
10969	MULETILLA ROSETA 575 35mm BL	50	11195	CERRADURA MUEBLE HEBILLA CM19 80x32mm CB	243	13075	CILINDRO SERRETA CS3 LLI/ L15 30x10mm NI	110
10970	MULETILLA ROSETA CUADRADA 131 35mm IN	50	11196	CERRADURA MUEBLE HEBILLA CM19 94x32mm CB	243	13076	CILINDRO SERRETA CS3 LLI/ L15 30x30mm NI	110
10973	MULETILLA ROSETA CUADRADA 131 53mm IN	50	11197	CERRADURA MUEBLE HEBILLA CM19 110x40mm CB	243	13077	CILINDRO SERRETA CS3 LLI/ L15 35x35mm NI	110
10974	MULETILLA ROSETA 898 50mm NM	50	11701	CLAVO REDONDO CL1 30x30mm NE	98	13078	CILINDRO SERRETA CS3 LLI/ L13 30x40mm NI	110
10975	MULETILLA ROSETA 898 50mm NN	50	11702	CLAVO REDONDO CL1 40x30mm NE	98	13079	CILINDRO SEGURIDAD CS2 L15 45x45mm LT	106
10976	MULETILLA ROSETA CUADRADA 848 50x50mm NM	51	11703	CLAVO PIRAMIDE CL3 30x30mm NE	98	13080	CILINDRO SEGURIDAD CS2 L15 45x45mm NI	106
10977	MULETILLA ROSETA CUADRADA 848 50x50mm NN	51	11705	TACHUELA PLANA TCH1 8x14mm LTD	415	13081	CILINDRO SEGURIDAD CS2 L15 30x60mm LT	106
10978	MULETILLA ROSETA 949 50mm CB	50	11706	TACHUELA PLANA TCH1 8x14mm CU	415	13082	CILINDRO SEGURIDAD CS2 L15 30x60mm NI	106
10981	MULETILLA MANILLA C/DESBLOQUEO 10098 CU	52	11707	TACHUELA PLANA TCH1 8x14mm PV	415	13083	CILINDRO SEGURIDAD CS2 L15 50x50mm LT	106
10982	MULETILLA MANILLA C/DESBLOQUEO 10098 NS	52	11708	TACHUELA PLANA TCH1 10x15mm LTD	415	13084	CILINDRO SEGURIDAD CS2 L15 50x50mm NI	106
10987	MULETILLA MANILLA C/DESBLOQUEO 10098 LE	52	11709	TACHUELA PLANA TCH1 10x15mm CU	415	13085	CILINDRO SERRETA CS3 L15 45x45mm LT	108
11012	OVALLILLO PERNIO OV1 LTD	179	11710	TACHUELA PLANA TCH1 10x15mm PV	415	13086	CILINDRO SERRETA CS3 L15 45x45mm NI	108
11013	OVALLILLO PERNIO OV1 NE	179	11711	TACHUELA PLANA TCH1 10x15mm BL	415	13087	CILINDRO SERRETA CS3 L15 23x23mm LT	108
11014	OVALLILLO PERNIO OV1 IN	179	11712	TACHUELA PLANA TCH1 10x15mm NE	415	13088	CILINDRO SERRETA CS3 L15 23x23mm NI	108
11015	PERNIO S/R DCHA PN9 95x54mm LTD	177	11717	TACHUELA PLANA TCH1 12x16mm LTD	415	13089	CILINDRO SEGURIDAD CS2 L15 40x60mm LT	106
11016	PERNIO S/R IZDA PN9 95x54mm LTD	177	11718	TACHUELA PLANA TCH1 12x16mm CU	415	13090	CILINDRO SEGURIDAD CS2 L15 40x60mm NI	106
11017	PERNIO S/R DCHA PN9 95x54mm NS	177	11719	TACHUELA PLANA TCH1 12x16mm LTD	415	13091	CILINDRO SEGURIDAD CS2 L15 30x70mm LT	106
11018	PERNIO S/R IZDA PN9 95x54mm NS	177	11720	CAJA CHINCHETA TCH2 SURTIDO (50 UNID)	415	13092	CILINDRO SEGURIDAD CS2 L15 30x70mm NI	106
11020	BISAGRA CR DCHA BS18 90x65x2,5mm IN	176	11722	CAJA CHINCHETA TCH2 NI (50 UNID)	415	13093	CILINDRO SEGURIDAD CS2 L15 60x60mm LT	106
11021	BISAGRA CR IZDA BS18 90x65x2,5mm IN	176	11725	CLAVO REDONDO CL1 25x30mm NE	98	13094	CILINDRO SEGURIDAD CS2 L15 60x60mm NI	106
11022	BISAGRA CC DCHA BS18 90x65x2,5mm IN	176	11726	CLAVO REDONDO CL1 35x30mm NE	98	13095	CILINDRO SEGURIDAD CS2 L15 40x80mm LT	106
11023	BISAGRA CC IZDA BS18 90x65x2,5mm IN	176	11727	CLAVO GOLF CL2 25x30mm NE	98	13096	CILINDRO SEGURIDAD CS2 L15 40x80mm NI	106
11024	BISAGRA CRS DCHA BS17 90x65x2,5mm IN	177	11728	CLAVO GOLF CL2 30x30mm NE	98	13097	CILINDRO SEGURIDAD CS2 L13 30x30mm LT	107
11025	BISAGRA CRS IZDA BS17 90x65x2,5mm IN	177	11729	CLAVO PIRAMIDE CL3 25x30mm NE	98	13098	CILINDRO SEGURIDAD CS2 L13 35x35mm LT	107
11028	BISAGRA CRS DCHA BS17 100x86x3mm IN	177	11730	CLAVO PIRAMIDE CL3 35x30mm NE	98	13099	CILINDRO SEGURIDAD CS2 L13 30x40mm LT	107
11029	BISAGRA CRS IZDA BS17 100x86x3mm IN	177	11731	CLAVO 8 PICOS CL4 30x30mm NE	98	13100	CILINDRO SEGURIDAD CS2 L13 40x40mm LT	107
11030	BISAGRA CCS DCHA BS17 100x86x3mm IN	177	11732	CLAVO 8 PICOS CL4 40x30mm NE	98	13101	CILINDRO SEGURIDAD CS2 L13 30x50mm LT	107
11031	BISAGRA CCS IZDA BS17 100x86x3mm IN	177	11733	CLAVO 4 PICOS CL5 20x20mm NE	98	13102	CILINDRO SEGURIDAD CS2 L13 30x50mm NI	107
11040	PERNIO C/R DCHA PN3 100x58mm LS	178	11734	CLAVO 4 PICOS CL5 40x30mm NE	98	13103	CILINDRO SERRETA CS3 L15 30x10mm LT	108
11041	PERNIO C/R IZDA PN3 100x58mm LS	178	11735	CLAVO GOLF CL2 35x30mm NE	98	13104	CILINDRO SERRETA CS3 L15 30x10mm NI	108
11060	PERNIO C/R DCHA PN3 100x58mm CU	178	11736	CLAVO GOLF CL2 40x30mm NE	98	13105	CILINDRO SERRETA CS3 L15 40x10mm LT	108
11061	PERNIO C/R IZDA PN3 100x58mm CU	178	11833	CASCABEL LATON CCB1 8mm NI	415	13106	CILINDRO SERRETA CS3 L15 40x10mm NI	108
11070	PERNIO C/R DCHA PN3 100x58mm NE	178	11834	CASCABEL LATON CCB1 11mm NI	415	13107	CILINDRO SERRETA CS3 L15 50x10mm LT	108
11071	PERNIO C/R IZDA PN3 100x58mm NE	178	11835	CASCABEL LATON CCB1 13mm NI	415	13108	CILINDRO SERRETA CS3 L15 50x10mm NI	108
11080	PERNIO S/R DCHA PN4 100x58mm LS	178	11836	CASCABEL LATON CCB1 15mm NI	415	13109	CILINDRO SERRETA CS3 L15 60x10mm LT	108
11081	PERNIO S/R IZDA PN4 100x58mm LS	178	11837	CASCABEL LATON CCB1 17mm NI	415	13110	CILINDRO SERRETA CS3 L15 60x10mm NI	108
11090	PERNIO S/R DCHA PN4 100x58mm NS	178	11838	CASCABEL LATON CCB1 20mm NI	415	13111	CILINDRO SERRETA CS3 L15 30x60mm LT	108
11091	PERNIO S/R IZDA PN4 100x58mm NS	178	11904	POMO PUERTA LISO PP2 70mm IN	93	13112	CILINDRO SERRETA CS3 L15 30x60mm NI	108
11092	POMO PUERTA LISO PP2 70mm NE	93	11960	MULETILLA ROSETA NYLON 707 35mm NS	51	13113	CILINDRO SERRETA CS3 L15 50x50mm LT	108
11131	CERRADURA MUEBLE CM1 26mm CB	240	11961	MULETILLA ROSETA 707 35mm LTD	51	13114	CILINDRO SERRETA CS3 L15 50x50mm NI	108
11132	CERRADURA MUEBLE LLI/ CM1 26mm CB	240	11962	MULETILLA ROSETA 707 35mm LS	51	13115	CILINDRO SERRETA CS3 L15 40x60mm LT	108
11133	CERRADURA MUEBLE CM1 32mm CB	240	11965	MULETILLA ROSETA 787 35mm CU	51	13116	CILINDRO SERRETA CS3 L15 40x60mm NI	108
11134	CERRADURA BUZON RECTA CM4 20mm CB	245	11966	MULETILLA ROSETA 707 35mm NS	51	13117	CILINDRO SERRETA CS3 L15 30x70mm LT	108
11135	CERRADURA BUZON CURVA CM5 20mm CB	245	11967	MULETILLA ROSETA 787 35mm LE	51	13118	CILINDRO SERRETA CS3 L15 30x70mm NI	108
11136	CERRADURA BUZON RECTA CM4 30mm CB	245	11969	MULETILLA ROSETA 787 35mm PE	51	13119	CILINDRO SERRETA CS3 L15 60x60mm LT	108
11137	CERRADURA PULSAR CM3 26-35mm CB	243	11987	MULETILLA MANILLA C/DESBLOQUEO 10098 BL	52	13120	CILINDRO SERRETA CS3 L15 60x60mm NI	108
11138	CERRADURA VITRINA CM8 120mm CB	244	11988	MULETILLA MANILLA C/DESBLOQUEO 10098 NE	52	13121	CILINDRO SERRETA CS3 L15 40x80mm LT	108
11139	CERRADERO ESCUADRA CM11 CB	241	12100	TUBO ARMARIO TA1 12x1mt CB	228	13122	CILINDRO SERRETA CS3 L15 40x80mm NI	108
11142	CERRADURA VITRINA LLI/ CM8 120mm CB	244	12150	TUBO ARMARIO TA1 12x1,5mts CB	228	13123	CILINDRO SEGURIDAD CS2 LLI/ L15 30x30mm LT	107
11143	LLAVE IGUAL CERRADURA MUEBLE CM12 NI	241	12200	TUBO ARMARIO TA1 12x2mts CB	228	13124	CILINDRO SEGURIDAD CS2 LLI/ L15 30x30mm NI	107
11144	CERRADURA PULSAR LLI/ CM3 26-35mm CB	243	12250	TUBO ARMARIO TA1 12x2,50mts CB	228	13125	CILINDRO SEGURIDAD CS2 LLI/ L15 35x35mm LT	107
11145	CERRADURA BUZON RECTA LLI/ CM4 20mm CB	245	12300	TUBO ARMARIO TA1 12x3mts CB	228	13126	CILINDRO SEGURIDAD CS2 LLI/ L15 25x35mm NI	107
11146	CERRADURA BUZON CURVA LLI/ CM5 20mm CB	245	12400	TUBO ARMARIO TA1 12x4mts CB	228	13127	CILINDRO SEGURIDAD CS2 LLI/ L15 30x40mm LT	107
11147	CERRADURA MUEBLE GANCHO CM2 22mm CB	240	12401	TUBO ARMARIO TA1 12x4mts BL	228	13128	CILINDRO SEGURIDAD CS2 LLI/ L15 30x40mm NI	107
11148	CERRADURA VITRINA 1P CM6 32x35mm CB	244	13002	ADAPTADOR UNIFICADO CERRADURA CS8 ZN	112	13129	CILINDRO SEGURIDAD CS2 LLI/ L15 40x40mm LT	107
11149	CERRADURA VITRINA 2P CM7 48x35mm CB	244	13003	LEVA L13 PICILINDRO CS2 NE	112	13130	CILINDRO SEGURIDAD CS2 LLI/ L15 40x40mm NI	107
11150	CERRADURA VITRINA 1P LLI/ CM6 32x35mm CB	244	13001	CILINDRO SEGURIDAD CS2 L15 30x30mm LT	106	13131	CILINDRO SEGURIDAD CS2 LLI/ L15 30x50mm LT	107
11151	CERRADURA VITRINA 2P LLI/ CM7 48x35mm CB	244						

NUMÉRICO

Código	Descripción	Pág.	Código	Descripción	Pág.	Código	Descripción	Pág.
13134	CILINDRO SEGURIDAD CS2 LL/I L13 35x35mm NI	107	13252	CANDADO ARCO NORMAL LL/I CN1 40mm LT	402	16150	TUBO ARMARIO TA1 16x1,5mts CB	228
13135	CILINDRO SEGURIDAD CS2 LL/I L13 30x40mm NI	107	13253	CANDADO ARCO NORMAL LL/I CN1 50mm LT	402	16200	TUBO ARMARIO TA1 16x2mts CB	228
13136	CILINDRO SEGURIDAD CS2 LL/I L13 40x40mm NI	107	13254	CANDADO ARCO NORMAL LL/I CN1 60mm LT	402	16250	TUBO ARMARIO TA1 16x2,5mts CB	228
13137	CILINDRO SEGURIDAD CS2 LL/I L13 30x50mm NI	107	13255	BL 3 CANDADO ARCO NORMAL LL/I CN1 15mm LT	402	16300	TUBO ARMARIO TA1 16x3mts CB	228
13138	CILINDRO SERRETA CS3 LL/I L15 40x40mm LT	108	13256	BL 3 CANDADO ARCO NORMAL LL/I CN1 20mm LT	402	16400	TUBO ARMARIO TA1 16x4mts CB	228
13139	CILINDRO SERRETA CS3 LL/I L15 40x40mm NI	108	13257	BL 3 CANDADO ARCO NORMAL LL/I CN1 25mm LT	402	16401	TUBO ARMARIO TA1 16x4mts BL	228
13140	CILINDRO SERRETA CS3 LL/I L15 30x50mm LT	108	13258	CANDADO ARCO LARGO CN2 20mm LT	403	16666	MANILLON PLACA 1666 LTD	31
13141	CILINDRO SERRETA CS3 LL/I L15 30x50mm NI	108	13259	CANDADO ARCO LARGO CN2 25mm LT	403	17001	BL JGO ROSETA 595 IN	13
13142	CILINDRO SERRETA CS3 LL/I L13 40x40mm NI	110	13260	CANDADO ARCO LARGO CN2 30mm LT	403	17002	BL JGO ROSETA L RECTA 565 IN	8
13143	CILINDRO SERRETA CS3 LL/I L13 30x50mm NI	110	13261	CANDADO ARCO LARGO CN2 40mm LT	403	17003	BL JGO ROSETA L CURVA 575 IN	9
13144	CILINDRO SERRETA CS3 L13 30x30mm LT	110	13262	CANDADO ARCO LARGO CN2 50mm LT	403	17004	BL JGO ROSETA U 585 IN	10
13145	CILINDRO SERRETA CS3 L13 35x35mm LT	110	13263	CANDADO ARCO LARGO CN2 60mm LT	403	17005	BL JGO MANILLA PORCELANA 787 CU	21
13146	CILINDRO SERRETA CS3 L13 30x40mm LT	110	13264	BL CANDADO ARCO LARGO CN2 20mm LT	403	17006	BL JGO MANILLA PORCELANA 787 LE	21
13147	CILINDRO SERRETA CS3 L13 40x40mm LT	110	13265	BL CANDADO ARCO LARGO CN2 25mm LT	403	17008	BL JGO ROSETA PORCELANA 787 CU	21
13148	CILINDRO SERRETA CS3 L13 30x50mm LT	110	13266	BL CANDADO ARCO LARGO CN2 30mm LT	403	17009	BL JGO ROSETA PORCELANA 787 LE	21
13149	CILINDRO SERRETA CS3 L13 30x50mm NI	110	13267	BL CANDADO ARCO LARGO CN2 40mm LT	403	17010	BL JGO ROSETA PORCELANA 787 PE*	21
13150	CILINDRO SEGURIDAD POMO CS6 L15 30x30mm LT	111	13268	BL CANDADO ARCO LARGO CN2 50mm LT	403	17011	BL JGO MANILLA 666 LP	30
13151	CILINDRO SEGURIDAD POMO CS6 L15 30x30mm NS	111	13269	BL CANDADO ARCO LARGO CN2 60mm LT	403	17013	BL JGO MANILLA 1666 LTD	31
13152	CILINDRO SEGURIDAD POMO CS6 L15 35x35mm LT	111	13270	CANDADO ARCO LARGO LL/I CN2 30mm LT	403	17014	BL JGO MANILLA 202 LTD	26
13153	CILINDRO SEGURIDAD POMO CS6 L15 35x35mm NS	111	13271	CANDADO ARCO LARGO LL/I CN2 40mm LT	403	17015	BL JGO MANILLA 202 BI	26
13154	CILINDRO SEGURIDAD POMO CS6 L15 30x40mm LT	111	13272	CANDADO ARCO LARGO LL/I CN2 50mm LT	403	17016	BL JGO MANILLA 202 NS	26
13155	CILINDRO SEGURIDAD POMO CS6 L15 30x40mm NS	111	13273	CANDADO RECTANGULAR CN3 60mm LT	403	17017	BL JGO MANILLA 202 CU	26
13156	CILINDRO SEGURIDAD POMO CS6 L15 40x40mm LT	111	13274	CANDADO RECTANGULAR CN3 70mm LT	403	17019	BL JGO MANILLA 777 LP	28
13157	CILINDRO SEGURIDAD POMO CS6 L15 40x40mm NS	111	13275	CANDADO RECTANGULAR CN3 90mm LT	403	17021	BL JGO MANILLA 1777 LTD	29
13158	CILINDRO SEGURIDAD POMO CS6 L15 30x50mm LT	111	13276	BL CANDADO RECTANGULAR CN3 60mm LT	403	17022	BL JGO MANILLA 1646 LTD	32
13159	CILINDRO SEGURIDAD POMO CS6 L15 30x50mm NS	111	13277	BL CANDADO RECTANGULAR CN3 70mm LT	403	17023	BL JGO MANILLA 1646 CU	32
13160	CILINDRO SERRETA POMO CS7 L15 30x30mm LT	111	13278	BL CANDADO RECTANGULAR CN3 90mm LT	403	17024	BL JGO MANILLA 919 CU	25
13161	CILINDRO SERRETA POMO CS7 L15 30x30mm NS	111	13279	CANDADO RECTANGULAR LL/I CN3 60mm LT	403	17025	BL JGO MANILLA 919 NS	25
13162	CILINDRO SERRETA POMO CS7 L15 35x35mm LT	111	13280	CANDADO RECTANGULAR LL/I CN3 70mm LT	403	17026	BL JGO ROSETA 919 CU	25
13163	CILINDRO SERRETA POMO CS7 L15 35x35mm NS	111	13281	CANDADO RECTANGULAR LL/I CN3 90mm LT	403	17027	BL JGO ROSETA 919 NS	25
13164	CILINDRO SERRETA POMO CS7 L15 30x40mm LT	111	13282	BL CANDADO ARCO NORMAL CN4 30mm IN	402	17028	BL JGO MANILLA 989 NS	33
13165	CILINDRO SERRETA POMO CS7 L15 30x40mm NS	111	13283	BL CANDADO ARCO NORMAL CN4 40mm IN	402	17029	BL JGO MANILLA 959 NS	33
13166	CILINDRO SERRETA POMO CS7 L15 40x40mm LT	111	13284	BL CANDADO ARCO NORMAL CN4 50mm IN	402	17030	BL JGO ROSETA 959 NS	33
13167	CILINDRO SERRETA POMO CS7 L15 40x40mm NS	111	13285	BL CANDADO COMBINACION CN5 20mm LT	404	17031	BL JGO MANILLA 707 LS	36
13168	CILINDRO SERRETA POMO CS7 L15 30x50mm LT	111	13286	BL CANDADO COMBINACION CN5 30mm LT	404	17032	BL JGO MANILLA 707 NS	36
13169	CILINDRO SERRETA POMO CS7 L15 30x50mm NS	111	13287	BL CANDADO COMBINACION CN5 40mm LT	404	17033	BL JGO ROSETA 707 LS	36
13170	CILINDRO SERRETA CS3 LL/I L15 30x10mm LT	108	13288	BL CANDADO COMBINACION CABLE CN6 SURTIDO	404	17034	BL JGO ROSETA 707 NS	36
13171	CILINDRO SERRETA CS3 LL/I L15 30x10mm NI	108	13289	LLAVE BRUTO CANDADO CN1/CN2 15mm NI	405	17035	BL JGO ROSETA CUADRADA 868 CN	38
13172	TORNILLO CILINDRO TRN16 M5x65mm LTD	112	13290	LLAVE BRUTO CANDADO CN1/CN2 20-25mm NI	405	17036	BL JGO ROSETA CUADRADA 878 NS	38
13173	TORNILLO CILINDRO TRN16 M5x65mm NI	112	13291	LLAVE BRUTO CANDADO CN4 30mm NI	405	17037	BL JGO ROSETA 404 LS	42
13174	CILINDRO SEGURIDAD CS1 L15 30x30mm LT	102	13292	LLAVE BRUTO CANDADO CN1/CN2 30mm NI	405	17038	BL JGO ROSETA 404 NS	42
13175	CILINDRO SEGURIDAD CS1 L15 30x30mm NI	102	13293	LLAVE BRUTO CANDADO CN1/CN2 40mm NI	405	17039	BL JGO ROSETA 909 NS	42
13176	CILINDRO SEGURIDAD CS1 L15 35x35mm LT	102	13294	LLAVE BRUTO CANDADO CN1/CN2/CN3 50-60mm NI	405	17040	BL JGO MANILLA 606 CU	37
13177	CILINDRO SEGURIDAD CS1 L15 35x35mm NI	102	13295	LLAVE BRUTO CANDADO CN4 40mm NI	405	17041	BL JGO MANILLA 606 LS	37
13178	CILINDRO SEGURIDAD CS1 L15 30x40mm LT	102	13296	GUARDAPARKING VERTICAL GPK1 600mm AM	408	17042	BL JGO MANILLA 606 NS	37
13179	CILINDRO SEGURIDAD CS1 L15 30x40mm NI	102	13297	LLAVE BRUTO CANDADO CN4 50mm NI	405	17043	BL JGO ROSETA 606 CN	37
13180	CILINDRO SEGURIDAD CS1 L15 40x40mm LT	102	13298	BL CANDADO FURGONETA CN7 73mm CB	406	17044	BL JGO ROSETA 606 CU	37
13181	CILINDRO SEGURIDAD CS1 L15 40x40mm NI	102	13299	CERROJO SEGURIDAD SOBREPONER CRR1 LTD	113	17045	BL JGO ROSETA 606 LS	37
13182	CILINDRO SEGURIDAD CS1 L15 30x50mm LT	102	13300	CERROJO SEGURIDAD SOBREPONER CRR1 NI	113	17046	BL JGO ROSETA 606 NS	37
13183	CILINDRO SEGURIDAD CS1 L15 30x50mm NI	102	13301	CERROJO SEGURIDAD SOBREPONER CRR2 PINTADO	113	17047	BL JGO ROSETA CUADRADA 616 CN	38
13184	CILINDRO SEGURIDAD CS1 L15 45x45mm LT	102	13302	GUARDALLAVES CAJA C/COMBINACION CN9 GR/NE	407	17048	BL JGO ROSETA CUADRADA 616 CU	38
13185	CILINDRO SEGURIDAD CS1 L15 45x45mm NI	102	13303	GUARDALLAVES CANDADO C/COMBINACION CN10 GR/NE	407	17049	BL JGO ROSETA CUADRADA 616 LS	38
13186	CILINDRO SEGURIDAD CS1 L15 30x60mm LT	102	13304	CILINDRO SEGURIDAD CS4 L15 30x30mm LT	104	17050	BL JGO ROSETA CUADRADA 616 NS	38
13187	CILINDRO SEGURIDAD CS1 L15 30x60mm NI	102	13305	CILINDRO SEGURIDAD CS4 L15 30x30mm NI	104	17051	BL JGO MANILLA 272 NE	16
13188	CILINDRO SEGURIDAD CS1 L15 40x50mm LT	102	13306	CILINDRO SEGURIDAD CS4 L15 35x35mm LT	104	17052	BL JGO MANILLA 242 NE	17
13189	CILINDRO SEGURIDAD CS1 L15 40x50mm NI	102	13307	CILINDRO SEGURIDAD CS4 L15 35x35mm NI	104	17053	BL JGO MANILLA 282 NE	18
13190	CILINDRO SEGURIDAD CS1 L15 50x50mm LT	102	13308	CILINDRO SEGURIDAD CS4 L15 30x40mm LT	104	17054	BL JGO MANILLA 292 NE	18
13191	CILINDRO SEGURIDAD CS1 L15 50x50mm NI	102	13309	CILINDRO SEGURIDAD CS4 L15 30x40mm NI	104	17055	BL BOCALLAVE PERA 707 50mm LS	49
13192	CILINDRO SEGURIDAD CS1 L13 30x30mm NI	102	13310	CILINDRO SEGURIDAD CS4 L15 40x40mm LT	104	17056	BL BOCALLAVE PERA 707 50mm NS	49
13193	CILINDRO SEGURIDAD CS1 L13 35x35mm NI	102	13311	CILINDRO SEGURIDAD CS4 L15 40x40mm NI	104	17057	BL BOCALLAVE PERA 787 50mm CU	49
13194	CILINDRO SEGURIDAD CS1 L13 30x40mm NI	102	13312	CILINDRO SEGURIDAD CS4 L15 30x50mm LT	104	17058	BL BOCALLAVE PERA 787 50mm LE	49
13195	LLAVE BRUTO CILINDRO SEGURIDAD CS1 NI	103	13313	CILINDRO SEGURIDAD CS4 L15 30x50mm NI	104	17059	BL BOCALLAVE PERA 787 50mm PE	49
13196	TORNILLO CILINDRO TRN16 M5x85mm LTD	112	13314	CILINDRO SEGURIDAD CS4 L13 30x30mm NI	105	17060	BL BOCALLAVE PERA 575 53mm IN	48
13197	TORNILLO CILINDRO TRN16 M5x85mm NI	112	13315	CILINDRO SEGURIDAD CS4 L13 35x35mm NI	105	17061	BL MULETILLA ROSETA 707 35mm LS	51
13198	CILINDRO SEGURIDAD CS4 LL/I G2 L15 30x30mm LT	104	13316	CILINDRO SEGURIDAD CS4 L13 30x40mm NI	105	17062	BL MULETILLA ROSETA 707 35mm NS	51
13199	CILINDRO SEGURIDAD CS4 LL/I G2 L15 30x30mm NI	104	13317	CILINDRO SEGURIDAD CS4 LL/I G1 L15 30x30mm LT	104	17064	BL MULETILLA ROSETA 787 35mm CU	51
13200	CILINDRO SEGURIDAD CS4 LL/I G2 L15 35x35mm LT	104	13318	CILINDRO SEGURIDAD CS4 LL/I G1 L15 30x30mm NI	104	17065	BL MULETILLA ROSETA 787 35mm LE	51
13201	CILINDRO SEGURIDAD CS4 LL/I G2 L15 35x35mm NI	104	13319	CILINDRO SEGURIDAD CS4 LL/I G1 L15 35x35mm LT	104	17066	BL MULETILLA ROSETA 787 35mm PE	51
13202	CILINDRO SEGURIDAD CS4 LL/I G2 L15 30x40mm LT	104	13320	CILINDRO SEGURIDAD CS4 LL/I G1 L15 35x35mm NI	104	17067	BL MULETILLA ROSETA 575 35mm IN	50
13203	CILINDRO SEGURIDAD CS4 LL/I G2 L15 30x40mm NI	104	13321	CILINDRO SEGURIDAD CS4 LL/I G1 L15 30x40mm LT	104	17069	BL MULETILLA MANILLA C/DESDBLOQUEO 10098 LP	52
13204	CILINDRO SEGURIDAD CS4 LL/I G2 L13 30x30mm NI	105	13322	CILINDRO SEGURIDAD CS4 LL/I G1 L15 30x40mm NI	105	17070	BL MULETILLA MANILLA C/DESDBLOQUEO 10098 CU	52
13205	CILINDRO SEGURIDAD CS4 LL/I G2 L13 35x35mm NI	105	13323	CILINDRO SEGURIDAD CS4 LL/I G1 L13 30x30mm NI	105	17071	BL MULETILLA MANILLA C/DESDBLOQUEO 10098 NS	52
13206	CILINDRO SEGURIDAD CS4 LL/I G2 L13 30x40mm NI	105	13324	CILINDRO SEGURIDAD CS4 LL/I G1 L13 35x35mm NI	105	17072	BL MULETILLA MANILLA C/DESDBLOQUEO 10098 LE	52
13207	CILINDRO SEGURIDAD CS4 LL/I G2 L15 30x30mm LT	104	13325	CILINDRO SEGURIDAD CS4 LL/I G1 L13 30x40mm NI	105	17073	BL MULETILLA MANILLA C/DESDBLOQUEO 10098 NE	52
13208	CILINDRO SEGURIDAD CS4 LL/I G3 L15 30x30mm NI	104	13343	ESTUCHE AMAESTRAMIENTO CILINDRO CS1	103	17075	BL JGO ROSETA 909 LS	42
13209	CILINDRO SEGURIDAD CS4 LL/I G3 L15 35x35mm LT	104	13344	GUARDALLAVES CAJA C/COMBINACION CN11 GR/NE	407	17080	BL JGO MANILLA 6800 ALUM BL	54
13210	CILINDRO SEGURIDAD CS4 LL/I G3 L15 35x35mm NI	104	13345	LEVA L13 P/CILINDRO CS1 NE	103	17081	BL JGO MANILLA 6800 ALUM NE	54
13211	CILINDRO SEGURIDAD CS4 LL/I G3 L15 30x40mm LT	104	13346	LLAVE BRUTO CANDADO FURGONETA CN7 LT	406	17082	BL JGO MANILLA 6800 ALUM PL	54
13212	CILINDRO SEGURIDAD CS4 LL/I G3 L15 30x40mm NI	104	13347	BL CANDADO COMBINACION CN8 20mm AZUL	404	17083	BL JGO MANILLA 6802 ALUM BL	54
13213	CILINDRO SEGURIDAD CS4 LL/I G3 L13 30x30mm NI	105	13348	BL CANDADO COMBINACION CN8 20mm ROJO	404	17084	BL JGO MANILLA 6802 ALUM NE	54
13214	CILINDRO SEGURIDAD CS4 LL/I G3 L13 35x35mm NI	105	13349	BL CANDADO COMBINACION CN8 20mm NE	404	17085	BL JGO MANILLA 6802 ALUM PL	54
13215	CILINDRO SEGURIDAD CS4 LL/I G3 L13 30x40mm NI	105	13350	BL CANDADO COMBINACION CN8 30mm AZUL	404	17086	BL CIERRE PRESION DCHA 6801 ALUM BL	56
13234	CANDADO ARCO NORMAL CN1 15mm LT	402	13351	BL CANDADO COMBINACION CN8 30mm ROJO	404	17087	BL CIERRE PRESION IZDA 6801 ALUM BL	56
13235	CANDADO ARCO NORMAL CN1 20mm LT	402	13352	BL CANDADO COMBINACION CN8 30mm NE	404	17088	BL CIERRE PRESION DCHA 6801 ALUM NE	56
13236	CANDADO ARCO NORMAL CN1 25mm LT	402	13353	BL CANDADO COMBINACION CN8 40mm AZUL	404	17089	BL CIERRE PRESION IZDA 6801 ALUM NE	56
13237	CANDADO ARCO NORMAL CN1 30mm LT	402	13354	BL CANDADO COMBINACION CN8 40mm ROJO	404	17090	BL CIERRE PRESION DCHA 6801 ALUM PL	56
13238	CANDADO ARCO NORMAL CN1 40mm LT	402	13355	BL CANDADO COMBINACION CN8 40mm NE	404	17091	BL CIERRE PRESION IZDA 6801 ALUM PL	56
13239	CANDADO ARCO NORMAL CN1 50mm LT	402	13356	LLAVE BRUTO CANDADO CN3 70-90mm NI	405	17092	BL CIERRE PRESION DCHA 6805 ALUM BL	57
13240	CANDADO ARCO NORMAL CN1 60mm LT	402	13357	BL CANDADO COMBINACION CN8 20mm VERDE	404	17093	BL CIERRE PRESION IZDA 6805 ALUM BL	57
13241	BL CANDADO ARCO NORMAL CN1 15mm LT	402	13358	BL CANDADO COMBINACION CN8 20mm MORADO	404	17094	BL CIERRE PRESION DCHA 6805 ALUM NE	57
13242	BL CANDADO ARCO NORMAL CN1 20mm LT	402	13359	BL CANDADO COMBINACION CN8 30mm VERDE	404	17095	BL CIERRE PRESION IZDA 6805 ALUM NE	57
13243	BL CANDADO ARCO NORMAL CN1 25mm LT	402	13360	BL CANDADO COMBINACION CN8 30mm MORADO	404	17096	BL CIERRE PRESION DCHA 6805 ALUM PL	57
13244	BL CANDADO ARCO NORMAL CN1 30mm LT	402	13361	BL CANDADO COMBINACION CN8 40mm VERDE	404	17097	BL CIERRE PRESION IZDA 6805 ALUM PL	57
13245	BL CANDADO ARCO NORMAL CN1 40mm LT	402	13362	BL CANDADO COMBINACION CN8 40mm MORADO	404	17098	BL JGO MANILLA 702 ALUM BL	55
13246	BL CANDADO ARCO NORMAL CN1 50mm LT	402	13363	KIT 2 CANDADOS FURGONETA LL/I CN7 73mm CB	406	17099	BL JGO MANILLA 702 ALUM NE	55
13247	BL CANDADO ARCO NORMAL CN1 60mm LT	402	13364	BL CERRADURA PICANUDO FURGONETA CN7 73mm CB	406	17100	BL JGO MANILLA 702 ALUM PL	55
13248	CANDADO ARCO NORMAL LL/I CN1 15mm LT	402	13365	LLAVE BRUTO CERROJO SEGURIDAD CRR1 NI	113	17101	BL JGO MANILLA C/B 6824 ALUM BL	58
13249	CANDADO ARCO NORMAL LL/I CN1 20mm LT	402	13366	LLAVE BRUTO CERROJO SEGURIDAD CRR2 NI	113	17102	BL JGO MANILLA C/B 6824 ALUM NE	58
13250	CANDADO ARCO NORMAL LL/I CN1 25mm LT	402	13367	LLAVE MULTIPLE CONTADOR LLV4 NI	416	17103	BL POMO RECUPERABLE 6807 ALUM BL	60
13251	CANDADO ARCO NORMAL LL/I CN1 30mm LT	402	16100	TUBO ARMARIO TA1 16x1mt CB	228	17104	BL POMO RECUPERABLE 6807 ALUM NE	60

NUMÉRICO

Código	Descripción	Pág.	Código	Descripción	Pág.	Código	Descripción	Pág.
17105	BL POMO RECUPERABLE 6807 ALUM PL	60	17217	BL JGO MANILLA 202 NE	51	18535	PERFIL MAMPARA JUNTA 23mm PF8 8/10mm TR	165
17106	BL ASA PLACA RECTA 6804 ALUM BL	60	17218	BL JGO ROSETA 202 NE	51	18536	PERFIL MAMPARA MAGNETICO 45° N-S PF2 8/10mm TR	166
17107	BL ASA PLACA RECTA 6804 ALUM NE	60	17219	BL JGO MANILLA 252 NE	50	18537	PERFIL MAMPARA MAGNETICO 45° S-N PF2 8/10mm TR	166
17108	BL ASA PLACA RECTA 6804 ALUM PL	60	17222	BL MULETILLA ROSETA CUADRADA 131 35mm IN	26	19100	TUBO ARMARIO TA1 19x1mt CB	228
17109	BL ASA PLACA REDONDA 6803 ALUM BL	61	17224	BL JGO MANILLA 797 LTD	26	19150	TUBO ARMARIO TA1 19x1,5mts CB	228
17110	BL ASA PLACA REDONDA 6803 ALUM NE	61	17225	BL JGO MANILLA 797 NS	19	19200	TUBO ARMARIO TA1 19x2mts CB	228
17111	BL ASA PLACA REDONDA 6803 ALUM PL	61	17226	BL JGO MANILLA 327 NS	50	19201	BISAGRA CAZOLETA RECTA BC2 35mm ZN	193
17112	BL JGO MANILLA 505 BI	24	17227	BL JGO ROSETA 327 NS	27	19202	BISAGRA CAZOLETA ACOD BC2 35mm ZN	193
17113	BL JGO MANILLA 505 CU	24	17228	BL JGO MANILLA 010 BI	27	19203	BISAGRA CAZOLETA S-AC BC2 35mm ZN	193
17114	BL JGO MANILLA 727 LP	22	17229	BL JGO MANILLA 010 CU	32	19211	BISAGRA CAZOLETA CLIP RECTA BC3 35mm ZN	193
17115	BL JGO MANILLA 727 NS	22	17230	BL JGO MANILLA 010 NS	32	19212	BISAGRA CAZOLETA CLIP ACOD BC3 35mm ZN	193
17116	BL JGO ROSETA 727 LP	22	17231	BL JGO MANILLA S/PLACA 181 LTD	27	19213	BISAGRA CAZOLETA CLIP S-AC BC3 35mm ZN	193
17117	BL JGO ROSETA 727 NS	22	17232	BL JGO MANILLA S/PLACA 181 NS	27	19214	BISAGRA CAZOLETA TETON RECTA BC4 35mm ZN	193
17118	BL JGO MANILLA PORCELANA 686 LE	20	17233	BL JGO MANILLA S/PLACA 181 CB	27	19215	BISAGRA CAZOLETA TETON ACOD BC4 35mm ZN	193
17119	BL JGO ROSETA PORCELANA 686 LE	20	17234	BL JGO MANILLA S/PLACA 181 NE	43	19216	BISAGRA CAZOLETA TETON S-AC BC4 35mm ZN	193
17120	BL JGO MANILLA 343 LP	22	17235	BL JGO MANILLA S/PLACA 181 BL	43	19217	BISAGRA CAZOLETA PISTON-TETON RECTA BC6 ZN	194
17121	BL JGO MANILLA 343 NS	22	17236	BL MULETILLA MANILLA C/DESBLOQUEO 10098 BL	43	19218	BISAGRA CAZOLETA PISTON-TETON ACOD BC6 ZN	194
17124	BL JGO MANILLA P/METALICA 232 25-38mm NE	47	17237	BL JGO MANILLA L CURVA 575 IN	43	19219	BISAGRA CAZOLETA PISTON-TETON S-AC BC6 ZN	194
17125	BL JGO MANILLA P/METALICA 232 25-38mm CB	47	17238	BL JGO MANILLA L CURVA 575 PVD	43	19221	BISAGRA CAZOLETA RECTA BC1 26mm ZN	193
17136	BL MULETILLA ROSETA CUADRADA 616 35mm NS	51	17239	BL JGO MANILLA L CURVA 575 NE	52	19222	BISAGRA CAZOLETA ACOD BC1 26mm ZN	193
17137	BL JGO MANILLA P/METALICA 232 35-50mm NE	47	17240	BL JGO MANILLA L CURVA 575 BL	9	19223	BISAGRA CAZOLETA S-AC BC1 26mm ZN	193
17138	BL JGO MANILLA P/METALICA 232 45-60mm NE	47	17241	BL JGO ROSETA L CURVA 575 PVD	9	19224	BISAGRA CAZOLETA 165° RECTA BC7 ZN	194
17139	BL JGO MANILLA C/BOCALLAVE 704 NE	46	17242	BL JGO ROSETA L CURVA 575 NE	9	19225	BISAGRA CAZOLETA 30° BC8 35mm ZN	195
17140	BL JGO MANILLA C/BOCALLAVE 704 NE	46	17243	BL JGO ROSETA L CURVA 575 BL	9	19226	BISAGRA CAZOLETA 45° BC8 35mm ZN	195
17141	BL JGO MANILLA C/POMO 704 NE	46	17244	BL JGO MANILLA 515 IN	9	19227	TAPA EMBELLEDDOR BISAGRA CAZOLETA BC5 ZN*	196
17142	BL JGO MANILLA 6827 ALUM BL	55	17245	BL JGO MANILLA 515 PVD	9	19228	BASE AVION CLIP TRIPLE REGULACION BC5 ZN*	196
17143	BL JGO MANILLA 6827 ALUM NE	55	17246	BL JGO MANILLA 515 NE	9	19229	BISAGRA CAZOLETA 165° ACOD BC7 ZN	194
17144	BL JGO MANILLA 6827 ALUM PL	55	17247	BL JGO MANILLA 515 BL	12	19230	BISAGRA CAZOLETA 165° S-AC BC7 ZN	194
17145	BL JGO MANILLA 6846 ALUM BL	55	17248	BL JGO ROSETA 515 IN	12	19234	BISAGRA CAZOLETA PUSH RECTA BC11 35mm ZN	194
17146	BL JGO MANILLA 6846 ALUM NE	55	17249	BL JGO ROSETA 515 PVD	12	19235	BISAGRA CAZOLETA PUSH ACOD BC11 35mm ZN	194
17147	BL JGO MANILLA 6846 ALUM PL	55	17250	BL JGO ROSETA 515 NE	12	19236	BISAGRA CAZOLETA PUSH S-AC BC11 35mm ZN	194
17148	BL JGO POMO PLACA C/B 6844 ALUM BL	59	17251	BL JGO ROSETA 515 BL	12	19237	BISAGRA CAZOLETA 90° RINCONERA BC12 ZN	195
17149	BL JGO POMO PLACA C/B 6844 ALUM NE	59	17252	BL JGO MANILLA L RECTA 565 IN	12	19238	BISAGRA CAZOLETA 90° PISTON RINCONERA BC13 ZN	195
17150	BL ASA PLACA C/B 6843 ALUM BL	59	17253	BL JGO MANILLA L RECTA 565 PVD	12	19241	BISAGRA CAZOLETA PISTON RECTA BC5 35mm ZN	194
17151	BL ASA PLACA C/B 6843 ALUM NE	59	17254	BL JGO MANILLA L RECTA 565 NE	12	19242	BISAGRA CAZOLETA PISTON ACOD BC5 35mm ZN	194
17152	BL JGO MANILLA 703 ALUM PL	47	17255	BL JGO MANILLA L RECTA 565 BL	8	19243	BISAGRA CAZOLETA PISTON S-AC BC5 35mm ZN	194
17153	BL JGO MANILLA 703 ALUM OR	47	17256	BL JGO ROSETA L RECTA 565 PVD	8	19250	TUBO ARMARIO TA1 19x2,5mts CB	228
17154	BL JGO ROSETA 545 IN	12	17257	BL JGO MANILLA L RECTA 565 NE	8	19300	TUBO ARMARIO TA1 19x3mts CB	228
17155	BL MULETILLA ROSETA 545 54mm IN	50	17258	BL JGO ROSETA L RECTA 565 BL	8	19310	BISAGRA FORMA T BS23 100mm ZN	190
17156	BL BOCALLAVE PERA 545 54mm IN	48	17259	BL JGO MANILLA U 585 IN	8	19313	BISAGRA FORMA T BS23 130mm ZN	190
17157	BL JGO ROSETA 202 LTD	26	17260	BL JGO MANILLA U 585 PVD	8	19315	BISAGRA FORMA T BS23 150mm ZN	190
17158	BL JGO ROSETA 202 BI	26	17261	BL JGO MANILLA U 585 NE	8	19317	BISAGRA FORMA T BS23 175mm ZN	190
17159	BL JGO ROSETA 202 NS	26	17262	BL JGO MANILLA U 585 BL	10	19320	BISAGRA FORMA T BS23 200mm ZN	190
17160	BL JGO ROSETA 202 CU	26	17263	BL JGO ROSETA U 585 PVD	10	19325	BISAGRA FORMA T BS23 250mm ZN	190
17161	BL JGO ROSETA 313 NS	41	17264	BL JGO ROSETA U 585 NE	10	19330	BISAGRA FORMA T BS23 300mm ZN	190
17162	BL JGO ROSETA 353 CN	41	17265	BL JGO ROSETA U 585 BL	10	19400	TUBO ARMARIO TA1 19x4mts CB	228
17163	BL JGO ROSETA 383 CN	35	17266	BL BOCALLAVE PERA 575 53mm PVD	10	19410	BISAGRA FORMA T BS23 100mm NE	190
17164	BL JGO ROSETA 373 CN	42	17267	BL BOCALLAVE PERA 575 53mm NE	10	19413	BISAGRA FORMA T BS23 130mm NE	190
17165	BL JGO ROSETA 383 NS	41	17268	BL BOCALLAVE PERA 575 53mm BL	10	19415	BISAGRA FORMA T BS23 150mm NE	190
17166	BL JGO ROSETA 383 LTD	41	17269	BL MULETILLA ROSETA 575 35mm PVD	48	19417	BISAGRA FORMA T BS23 175mm NE	190
17167	BL JGO ROSETA 393 NS	40	17270	BL MULETILLA ROSETA 575 35mm NE	48	19420	BISAGRA FORMA T BS23 200mm NE	190
17168	BL JGO ROSETA CUADRADA 424 NS	39	17271	BL MULETILLA ROSETA 575 35mm BL	48	19425	BISAGRA FORMA T BS23 250mm NE	190
17169	BL JGO ROSETA CUADRADA 434 NS	39	17272	BL JGO ROSETA 020 NE	50	19430	BISAGRA FORMA T BS23 300mm NE	190
17170	BL JGO ROSETA 454 NS	40	17273	BL JGO ROSETA 606 NE	50	20020	POMO ARMARIO BOLA PA1 20mm LP	203
17171	BL JGO ROSETA CUADRADA 464 NS	39	17274	BL JGO ROSETA 707 NE	50	20025	POMO ARMARIO BOLA PA1 25mm LP	203
17172	BL JGO ROSETA 464 NS	40	17275	BL JGO MANILLA 6842 ALUM BL	19	20027	POMO ARMARIO BOLA PA10 28mm NS	203
17173	BL JGO ROSETA 474 NS	35	17276	BL JGO MANILLA 6842 ALUM NE	37	20028	POMO ARMARIO MUESCA PA12 20mm NS	202
17174	BL JGO ROSETA 484 NS	42	17277	BL JGO MANILLA 6842 ALUM PL	36	20029	POMO ARMARIO BOLA PA11 20mm LTD	203
17175	BL JGO ROSETA 484 LTD	42	17278	BL JGO MANILLA CIEGA 6824 ALUM BL	54	20030	POMO ARMARIO BOLA PA1 30mm LP	203
17176	BL JGO ROSETA 494 NS	35	17279	BL JGO MANILLA CIEGA 6824 ALUM NE	54	20031	POMO ARMARIO BOLA PA11 20mm NS	203
17177	BL JGO ROSETA 494 LTD	35	17280	BL ASA PLACA CIEGA 6843 ALUM BL	54	20032	POMO ARMARIO BOLA PA11 25mm LTD	203
17178	BL JGO ROSETA 494 CU	35	17281	BL ASA PLACA CIEGA 6843 ALUM NE	58	20033	POMO ARMARIO BOLA PA11 25mm NS	203
17179	BL JGO ROSETA 303 NS	41	17282	BL JGO POMO PLACA CIEGA 6844 ALUM BL	58	20034	POMO ARMARIO MARGARITA PA13 14mm LT	204
17180	BL JGO ROSETA 303 LTD	41	17283	BL JGO POMO PLACA CIEGA 6844 ALUM NE	58	20035	POMO ARMARIO MARGARITA PA13 16mm LT	204
17181	BL JGO ROSETA 101 NS	40	17284	BL CIERRE PRESION L/LI DCHA 6858 ALUM BL	58	20036	POMO ARMARIO MARGARITA PA13 18mm LT	204
17182	BL JGO ROSETA 101 LTD	40	17285	BL CIERRE PRESION L/LI IZDA 6858 ALUM BL	59	20037	POMO ARMARIO MARGARITA PA13 20mm LT	204
17183	BL JGO MANILLA 1777 CU	29	17286	BL CIERRE PRESION L/LI DCHA 6858 ALUM NE	59	20202	POMO ARMARIO BOLA PA1 20mm NS	203
17184	BL JGO ROSETA 707 CB	36	17287	BL CIERRE PRESION L/LI IZDA 6858 ALUM NE	56	20252	POMO ARMARIO BOLA PA1 25mm NS	203
17185	BL MULETILLA ROSETA 707 35mm LTD	51	17288	BL CIERRE PRESION DCHA 6864 ALUM PL	56	20253	POMO ARMARIO BOLA PA1 25mm CU	203
17186	BL BOCALLAVE PERA 707 50mm LTD	49	17289	BL CIERRE PRESION IZDA 6864 ALUM PL	56	20302	POMO ARMARIO BOLA PA1 30mm NS	203
17187	BL JGO ROSETA CUADRADA 131 IN	14	17290	BL JGO MANILLA PLACA ANCHA 707 LTD	56	20400	TUBO ARMARIO TA1 25x4mts CB	228
17188	BL JGO ROSETA CUADRADA 161 IN	14	17291	BL JGO MANILLA PLACA ANCHA 707 NS	56	20701	PERNIO S/R DCHA PN7 100x58mm IN	177
17189	BL JGO ROSETA CUADRADA 191 IN	14	17292	BL ASA CORREDERA 6809 ALUM BL	56	20702	PERNIO S/R IZDA PN7 100x58mm IN	177
17190	BL JGO ROSETA CUADRADA 656 IN	15	17293	BL ASA CORREDERA 6809 ALUM NE	36	20703	PERNIO S/R DCHA PN7 80x50mm IN	177
17191	BL JGO ROSETA CUADRADA 676 IN	14	17294	BL ASA CORREDERA 6809 ALUM PL	36	20704	PERNIO S/R IZDA PN7 80x50mm IN	177
17192	BL JGO ROSETA 636 IN	13	17771	JGO MANILLA 1777 CU	29	21270	POMO ARMARIO BOLA PA9 20mm IN	203
17193	BL JGO ROSETA 717 IN	15	17776	MANILLON PLACA 1777 LTD	29	21271	POMO ARMARIO BOLA PA9 25mm IN	203
17194	BL JGO ROSETA 737 IN	12	18001	RETENEDOR PUERTA PARED RT5 LTD	127	21273	POMO ARMARIO MUESCA PA6 15mm IN	202
17195	BL JGO ROSETA 747 IN	13	18002	RETENEDOR PUERTA PARED RT5 CB	127	21274	POMO ARMARIO MUESCA PA6 20mm IN	202
17196	BL JGO ROSETA 767 IN	15	18011	RETENEDOR PUERTA SUELO RT4 LTD	127	21275	POMO ARMARIO MUESCA PA6 25mm IN	202
17197	BL BOCALLAVE PERA CUADRADO 131 53x53mm IN	49	18012	RETENEDOR PUERTA SUELO RT4 CB	127	21277	POMO ARMARIO CONICO PA7 12mm IN	201
17198	BL JGO ROSETA CUADRADA 848 NM	34	18516	JGO SOPORTE AIRE AC1 500x400mm BE	303	21278	POMO ARMARIO CONICO PA7 20mm IN	201
17199	BL JGO ROSETA CUADRADA 848 NN	34	18517	JGO SOPORTE AIRE AC1 500x450mm BE	303	21279	POMO ARMARIO CONICO PA8 30mm IN	201
17200	BL JGO ROSETA 898 NM	34	18518	JGO SOPORTE AIRE AC1 500x500mm BE	303	21280	POMO ARMARIO PLANO PA5 31mm CM	204
17201	BL JGO ROSETA 898 NN	34	18519	JGO AMORTIGUADORES AC2 35kgs NE	303	21281	POMO ARMARIO PLANO PA5 31mm NS	204
17202	BL JGO ROSETA 949 CB	35	18520	JGO AMORTIGUADORES AC2 45kgs NE	303	21282	POMO ARMARIO PLANO PA8 20mm IN	201
17203	BL JGO ROSETA CUADRADA 969 NM	34	18521	SOPORTE C/GARRAFA Sils AIRE AC3	303	21283	POMO ARMARIO CUADRADO PA14 20mm IN	202
17204	BL JGO ROSETA CUADRADA 969 NN	34	18522	PERFIL MAMPARA MAGNETICO 180° PF1 6/8mm TR	166	21284	POMO ARMARIO CUADRADO PA14 25mm IN	202
17205	BL JGO ROSETA CUADRADA 090 NN	34	18523	PERFIL MAMPARA MAGNETICO 45° N-S PF2 6/8mm TR	166	21285	POMO ARMARIO CILINDRICO PA15 20mm IN	201
17206	BL JGO ROSETA CUADRADA 090 NN	34	18524	PERFIL MAMPARA MAGNETICO 45° S-N PF2 6/8mm TR	166	21286	POMO ARMARIO CILINDRICO PA15 25mm IN	201
17207	BL BOCALLAVE PERA 898 50mm NM	48	18525	PERFIL MAMPARA BURBUJA PF3 6/8mm TR	164	22001	TIRADOR ARCO TRM8 128mm IN	199
17208	BL BOCALLAVE PERA 898 50mm NN	48	18526	PERFIL MAMPARA BURBUJA PF3 8/10mm TR	164	22006	TIRADOR CARRUSEL TRM7 64mm IN	199
17209	BL BOCALLAVE PERA 949 50mm CB	49	18527	PERFIL MAMPARA BAÑERA PF4 6/8mm TR	164	22007	TIRADOR CARRUSEL TRM7 96mm IN	199
17210	BL BOCALLAVE PERA CUADRADO 848 50x50mm NM	48	18528	PERFIL MAMPARA JUNTA CRUCE 18mm PF5 6/8mm TR	165	22008	TIRADOR CARRUSEL TRM7 128mm IN	199
17211	BL BOCALLAVE PERA CUADRADO 848 50x50mm NN	48	18529	PERFIL MAMPARA VIERTEAGUA 19,5mm PF6 6/8mm TR	164	22014	TIRADOR TRM2 160mm CM	198
17212	BL MULETILLA ROSETA 898 50mm NM	50	18530	PERFIL MAMPARA VIERTEAGUA 11,5mm PF6 6/8mm TR	164	22021	TIRADOR TRM5 128mm CM	198
17213	BL MULETILLA ROSETA 898 50mm NN	50	18531	PERFIL MAMPARA VIERTEAGUA CENTRAL PF7 6/8mm TR	165	22022	TIRADOR TRM5 128mm CB	198
17214	BL MULETILLA ROSETA CUADRADA 848 50x50mm NM	51	18532	PERFIL MAMPARA JUNTA 23mm PF8 6/8mm TR	165	22023	TIRADOR TRM5 128mm NS	198
17215	BL MULETILLA ROSETA CUADRADA 848 50x50mm NN	51	18533	PERFIL MAMPARA JUNTA 13mm PF8 6/8mm TR	165	22032	TIRADOR TRM1 128mm NS	198
17216	BL MULETILLA ROSETA 949 50mm CB	50	18534	PERFIL MAMPARA VIERTEAGUA 11,5mm PF6 8/10mm TR	164	22042	TIRADOR TRM4 160mm CB	198

NUMÉRICO

Código	Descripción	Pág.	Código	Descripción	Pág.	Código	Descripción	Pág.
22043	TIRADOR TRM4 160mm CM	198	30020	PASADOR EMBUTIR C/C PS8 200mm LTD	137	30551	CADENA REDONDA GRABADA CDN5 3,4x43x1mt NI	409
22044	TIRADOR TRM4 160mm NS	198	30101	PASADOR EMBUTIR PS10 152mm LP	137	30552	CADENA REDONDA GRABADA CDN5 3,4x43x1mt NE	409
22048	TIRADOR TRM16 192mm IN	201	30102	PASADOR EMBUTIR PS10 200mm LP	137	30553	CADENA TORCIDA LISA CDN6 2x10x30mts LTD	409
22049	TIRADOR TRM17 128mm IN	200	30103	PASADOR EMBUTIR PS10 305mm LP	137	30554	CADENA TORCIDA LISA CDN6 2x10x30mts NI	409
22050	TIRADOR TRM17 192mm IN	200	30104	PASADOR EMBUTIR PS10 152mm NS	137	30557	CADENA CATEDRAL CDN7 2,2x24x30mts LTD	409
22051	TIRADOR TRM17 256mm IN	200	30105	PASADOR EMBUTIR PS10 200mm NS	137	30558	CADENA BOLAS CDN8 3,2x50mts CB	410
22052	TIRADOR TRM17 320mm IN	200	30106	PASADOR EMBUTIR PS10 305mm NS	137	30559	CADENA BOLAS CDN8 4x50mts CB	410
22053	TIRADOR TRM18 160mm IN	200	30150	PASADOR COLA MILANO PS13 50mm LP*	134	30560	ENGANCHE CADENA BOLAS CDN8 3,2mm CB	410
22054	TIRADOR TRM18 192mm IN	200	30151	PASADOR EMBUTIR C/C PS8 160mm NS	137	30561	ENGANCHE CADENA BOLAS CDN8 4mm CB	410
22055	TIRADOR TRM18 256mm IN	200	30155	PASADOR EMBUTIR C/R PS9 160mm LTD	137	30562	ENGANCHE LLAVERO CADENA CDN8 3,2mm CB	410
22056	TIRADOR TRM18 320mm IN	200	30156	PASADOR EMBUTIR C/R PS9 160mm NS	137	30563	ENGANCHE LLAVERO CADENA CDN8 4mm CB	410
22057	TIRADOR TRM19 160mm IN	200	30160	PASADOR COLA MILANO PS13 60mm LP*	134	30564	LLAVERO ANILLA CADENA CDN8 18mm CB	410
22058	TIRADOR TRM19 192mm IN	200	30201	PASADOR EMBUTIR C/C PS8 200mm NS	137	30565	CADENA BOLAS MONTADA CDN8 3,2x250mm CB	410
22059	TIRADOR TRM19 256mm IN	200	30202	TORNILLO ENSAMBLE TNE1 5x50mm ZN	279	30566	CADENA BOLAS MONTADA CDN8 4x400mm CB	410
22060	TIRADOR TRM20 128mm IN	200	30203	TORNILLO ENSAMBLE TNE1 7x50mm ZN	279	30615	BISAGRA ESTUCHE BS22 13x15mm LP	189
22065	TIRADOR EMBUTIR REDONDO TE5 65mm IN	206	30212	TORNILLO ENSAMBLE TNE1 5x50mm NE	279	30620	BISAGRA ESTUCHE BS22 13x20mm LP	189
22066	TIRADOR EMBUTIR RECTANGULAR TE8 150x50mm IN	207	30213	TORNILLO ENSAMBLE TNE1 7x50mm NE	279	30625	BISAGRA ESTUCHE BS22 13x25mm LP	189
22067	TIRADOR EMBUTIR CUADRADO TE7 50x50mm IN	207	30301	TORNILLO ENSAMBLE TNE8 34-44mm MA	280	30725	CIERRE ESTUCHE CC11 25mm LP	189
22068	TIRADOR EMBUTIR CUADRADO TE7 70x70mm IN	207	30302	TORNILLO ENSAMBLE TNE8 34-44mm PL	280	30795	OVALLILLO ARANDELA OV3 12mm LTD	277
22069	TIRADOR EMBUTIR CUADRADO C/M TE9 80x80mm IN	206	30311	TORNILLO ENSAMBLE TNE8 26-36mm MA	280	30796	OVALLILLO ARANDELA OV3 14mm LTD	277
22070	TIRADOR EMBUTIR RECTANGULAR C/M TE10 155x45mm IN	206	30312	TORNILLO ENSAMBLE TNE8 26-36mm PL	280	30797	OVALLILLO ARANDELA OV3 12mm NI	277
22071	TIRADOR EMBUTIR OVAL C/M TE11 155x45mm IN	206	30316	TUERCA SILLA TRC8 3/16 ZN	283	30798	OVALLILLO ARANDELA OV3 14mm NI	277
22072	TIRADOR EMBUTIR MEDIA LUNA TE13 40x40mm IN	207	30384	TUBO ESQUINERO OVAL TA6 30x1mt PL	229	30799	GRAPA TRASERA REDONDA GRP2 15mm ZN	277
22073	TIRADOR EMBUTIR MEDIA LUNA TE13 50x50mm IN	207	30385	TUBO ESQUINERO OVAL TA6 30x1mt OR*	229	30800	GRAPA TRASERA RECTANGULAR GRP1 23x17mm ZN	277
22120	TIRADOR EMBUTIR OVAL TE6 120x40mm IN	207	30386	TUBO ARMARIO RETRAC OVAL TA3 25x15x1,5mts LTD	229	30801	TUERCA EMBULO TRC7 M6x10x14mm NI	276
22121	TIRADOR EMBUTIR RECT PCR1 165x54mm NE	147	30387	TUBO ARMARIO ALUM OVAL TA4 30x15x2mts PL	229	30802	TUERCA EMBUTIR TRC3 1/4x10x12mm BC*	276
22122	JGO TIRADOR REDONDO PCR1 50mm NE	147	30388	TUBO ARMARIO ALUM OVAL TA4 30x15x2mts OR	229	30804	TUERCA PUA EMBUTIR TRC2 M4 ZN	276
22123	JGO MANILLON RECTO PCR1 180x25mm NE	147	30390	TUBO ARMARIO RETRAC OVAL TA3 30x15x1mt CB	229	30806	TUERCA PUA EMBUTIR TRC2 M6 ZN	276
22150	MANILLON CUADRADO 656 150x19mm IN	15	30391	TUBO ARMARIO RETRAC OVAL TA3 30x15x2mts CB	229	30808	TUERCA PUA EMBUTIR TRC2 M8 ZN	276
22200	MANILLON CUADRADO 656 200x19mm IN	15	30394	TUBO ARMARIO RETRAC OVAL TA3 25x15x1,5mts CB	229	30810	TUERCA PUA EMBUTIR TRC2 M10 ZN	276
22250	MANILLON CUADRADO 656 250x19mm IN	15	30395	TUBO ARMARIO RETRAC OVAL TA3 19x1,5mts CB	229	30812	EXCENTRICA 15 EX6 12,5x8mm ZN	273
22300	MANILLON CUADRADO 656 300x19mm IN	15	30396	TUBO ARMARIO RETRAC OVAL TA3 25x15x2,5mts CB	229	30813	EXCENTRICA 15 EX6 14x9mm ZN	273
22301	MANILLON ROSETA CUADRADO 656 IN	15	30400	TUBO ARMARIO ALUM OVAL TA4 30x15x4mts PL	229	30814	PERNO R/MADERA EX6 45x34x11mm ZN	273
24096	TIRADOR VARILLA TRM9 96mm IN	199	30401	TUBO ARMARIO ALUM OVAL TA4 30x15x4mts OR	229	30815	PERNO M6 EX6 42x34x8mm ZN	273
24128	TIRADOR VARILLA TRM9 128mm IN	199	30404	TUBO ARMARIO RETRAC TA3 19x1mt CB	229	30816	TAPON EXCENTRICA EX6 17mm BL	273
24160	TIRADOR VARILLA TRM9 160mm IN	199	30405	TUBO ARMARIO RETRAC TA3 19x2mts CB	229	30817	TAPON EXCENTRICA EX6 17mm MA	273
24192	TIRADOR VARILLA TRM9 192mm IN	199	30406	TUBO ARMARIO RETRAC OVAL TA3 25x15x1mt CB	229	30818	TAPON EXCENTRICA EX6 17mm NE	273
24210	TIRADOR ARMARIO S/B 242 NE	19	30407	TUBO ARMARIO RETRAC OVAL TA3 25x15x2mts CB	229	30819	ENGANCHE EXCENTRICA EX4 13x8x16mm NI	272
24213	TIRADOR MALETERO 242 NE	19	30408	TUBO ARMARIO RETRAC OVAL TA3 25x15x1mt LTD	229	30822	ENGANCHE EXCENTRICA EX4 13x8x16mm NE*	272
24216	MANILLON PLACA 242 NE	17	30409	TUBO ARMARIO RETRAC OVAL TA3 25x15x2mts LTD	229	30823	ENGANCHE EX5 13x8x16mm BL	269
24256	TIRADOR VARILLA TRM9 256mm IN	199	30410	TORNILLO TIRADOR TRN8 M4x10mm ZN	210	30826	TORNILLO ENGANCHE EX5 14x6mm ZN	269
24320	TIRADOR VARILLA TRM9 320mm IN	199	30414	TORNILLO TIRADOR TRN8 M4x14mm ZN	210	30828	TUERCA EMBUTIR TRC3 M6x12x12mm ZN	275
24384	TIRADOR VARILLA TRM9 384mm IN	199	30420	TORNILLO TIRADOR TRN8 M4x20mm ZN	210	30829	TUERCA EMBUTIR TRC3 M6x12x14mm ZN	275
24448	TIRADOR VARILLA TRM9 448mm IN	199	30422	TORNILLO TIRADOR TRN8 M4x22mm ZN	210	30830	TUERCA EMBUTIR TRC3 M6x13x16mm BC	275
24512	TIRADOR VARILLA TRM9 512mm IN	199	30425	TORNILLO TIRADOR TRN8 M4x25mm ZN	210	30831	TUERCA EMBUTIR TRC4 M6x11x11mm BL	275
25200	TUBO ARMARIO OVAL TA2 25x15x2mts CB	228	30428	TORNILLO TIRADOR TRN8 M4x28mm ZN	210	30832	PERNO R/MADERA EX4 6x11mm ZN	272
25201	TUBO ARMARIO OVAL TA2 25x15x2mts LTD	228	30430	TORNILLO TIRADOR TRN8 M4x30mm ZN	210	30833	TUERCA EXPANSIBLE TRC6 M6x12x8mm LT	275
25400	TUBO ARMARIO OVAL TA2 25x15x4mts CB	228	30435	TORNILLO TIRADOR TRN8 M4x35mm ZN	210	30834	TORNILLO EURO TRN17 6,3x7,7x10mm ZN	277
25401	TUBO ARMARIO OVAL TA2 25x15x4mts LTD	228	30440	TORNILLO TIRADOR TRN8 M4x40mm ZN	210	30835	TUERCA EMBUTIR TRC3 M10x15x17mm BC	275
25402	TUBO ARMARIO OVAL TA2 25x15x4mts BL	228	30445	TORNILLO MULTICORTE TRN7 M4x45mm BC	210	30836	TACO GRAFILADO TC1 M6x23x8mm LT	274
25403	TUBO ARMARIO OVAL TA2 30x15x4mts CB	228	30446	TORNILLO MULTICORTE TRN7 M4x45mm ZN	210	30837	TACO GRAFILADO TC1 M8x28x10mm LT	274
26032	TIRADOR ALUMINIO TRM6 32mm CM	199	30480	TORNILLO TIRADOR TRN8 M4x8mm ZN	210	30838	ENGANCHE EX1 10,5x7x14mm GR	270
26064	TIRADOR ALUMINIO TRM6 64mm CM	199	30500	TORNILLO ENSAMBLE TNE7 78x28mm ZN	278	30839	PERNO ENGANCHE MADERA EX1 ZN	270
26128	TIRADOR ALUMINIO TRM6 128mm CM	199	30502	TORNILLO ENSAMBLE TNE6 39x39mm BC	279	30840	PERNO ENGANCHE EURO EX1 ZN	270
26160	TIRADOR ALUMINIO TRM6 160mm CM	199	30503	BL RETENEDOR CADENILLA RT2 85x38mm LTD	128	30841	PERNO ENGANCHE PRESION EX1 ZN	270
27216	MANILLON PLACA 272 NE	16	30504	BL RETENEDOR CADENILLA RT2 85x38mm NI	128	30842	ENGANCHE EX2 13,4x16mm GR	271
27361	ASA COMODILLA TRM10 36x36mm OR*	204	30506	ENGANCHE STRONG ENG2 BL	279	30843	SOPORTE ENGANCHE TACO EX2 NI	271
27364	TIRADOR HIERRO TRM14 145mm ZN	205	30507	ENGANCHE STRONG ENG2 MA	279	30844	SOPORTE ENGANCHE TORNILLO EX2 NI	271
27365	TIRADOR HIERRO TRM14 170mm ZN	205	30508	ENGANCHE STRONG ENG3 ZN	279	30845	TUERCA EMBUTIR TRC5 M6x10x13mm ZKN	275
27366	TIRADOR CAJA TRM15 80mm NI	205	30510	CIERRE CAJA CANDADO CC1 75x23mm ZN	290	30846	ENSAMBLE ENCIMERA ENS1 M8x48mm BL	284
27367	TIRADOR CAJA TRM15 100mm NI	205	30511	CIERRE CAJA CC1 75x23mm ZN	290	30847	ENSAMBLE ENCIMERA ENS2 M6x150mm ZN	284
27368	TIRADOR CAJA TRM15 120mm NI	205	30512	CIERRE CAJA CC3 53x23mm ZN	291	30848	TUERCA EMBUTIR TRC5 M8x12x18mm ZKN	275
27369	TIRADOR CAJA TRM15 140mm NI	205	30513	BL JGO SOPORTE ESPEJOS SC7 45x25mm ZN	297	30849	EXCENTRICA 25 EX7 11,7x6,6mm	274
27370	TIRADOR CAJA TRM15 160mm NI	205	30514	UNION PANELES SUSPENDIDOS ENS3 NE	284	30850	COLGADOR MUEBLE SENCILLO CG9 ZN	325
27801	ASA COMODILLA TRM11 80x36mm ORO	204	30515	UNION PANELES SOBREPUESTOS ENS4 NE	284	30851	COLGADOR MUEBLE EMBUTIR CG10 ZN	325
27802	ASA COMODILLA TRM11 80x36mm CM	204	30516	PIVOTE CENTRADOR MESA ESM3 8mm LTD	289	30852	ENGANCHE EX3 M6x31,7x18,3mm NI	272
27803	ASA COMODILLA TRM11 80x36mm CU	204	30517	PIVOTE CENTRADOR MESA ESM3 10mm LTD	289	30853	EXCENTRICA 35 EX8 6,3x9,4mm ZN	274
28001	PERCHA RUSTICA PER16 108x75mm LE	334	30518	RETENEDOR VENTANA CLIP1 NE	129	30854	PERNO M6 EX8 44x35x9mm ZN	276
28003	PERCHA RUSTICA PER16 108x75mm PE	334	30519	RETENEDOR VENTANA CLIP2 NE	129	30855	MEDIA LUNA MDL1 M8x32mm	274
28004	PERCHA RUSTICA PER16 108x75mm LP	334	30520	RETENEDOR PUERTA CLIP3 NE	127	30856	MEDIA LUNA MDL1 M8x32mm	276
28008	PERCHA TREBOL PER4 80x65mm LTD	338	30521	ESCUADRA MESA ESM1 60x34x34mm ZN	289	30857	MEDIA LUNA MDL2 6x28mm BL	276
28009	PERCHA TREBOL PER4 80x65mm ZN	338	30522	ESCUADRA MESA ESM2 60x38x60mm ZN	289	30858	COLGADOR MUEBLE EMBUTIR CG22 ZN	326
28010	PERCHA TREBOL PER4 80x65mm BL	338	30523	BL RETENEDOR PUERTA RT1 108x63mm LTD	128	30880	COLGADOR MUEBLE DOBLE CG9 ZN	325
28011	PERCHA RUSTICA PER17 205x75mm LE	335	30524	BL RETENEDOR PUERTA RT1 108x63mm NS	128	30881	COLGADOR MUEBLE REVERSIBLE CG8 ZN	325
28013	PERCHA RUSTICA PER17 205x75mm PE	335	30525	CIERRE CAJA CC1 131x43mm ZN	290	30940	PLACA COLGADOR GALERIA CG11 40x18mm ZN	326
28014	PERCHA RUSTICA PER17 205x75mm LP	335	30526	CIERRE CAJA CANDADO CC1 131x43mm ZN	290	30950	PLACA COLGADOR GALERIA CG11 50x18mm ZN	326
28015	PERCHA FORJA PER5 70x70mm NE	334	30527	CIERRE CAJA CC1 100x34mm ZN	290	30960	PLACA COLGADOR GALERIA CG11 60x18mm ZN	326
28016	PERCHA FORJA PER6 70x70mm NE	334	30528	CIERRE CAJA CANDADO CC1 100x34mm ZN	290	30970	PLACA COLGADOR GALERIA CG11 70x20mm ZN	326
28017	PERCHA FORJA PER7 120x85mm NE	335	30529	CIERRE CAJA CC2 42x23mm ZN	290	30980	PLACA COLGADOR GALERIA CG11 80x20mm ZN	326
28018	PERCHA FORJA PER8 120x85mm NE	335	30530	CIERRE CAJA CANDADO CC2 42x23mm ZN	290	31011	PORTAESTANTE ARANDELA PE3 5x16mm LTD	265
28023	PERCHA REDONDA PER1 32x50mm IN	337	30531	CIERRE CAJA CC4 50x22mm ZN	291	31013	PORTAESTANTE ARANDELA PE3 5x16mm ZN	265
28024	PERCHA DOBLE PER2 170x72x42mm IN	336	30532	CIERRE CAJA CC5 70x28mm ZN	291	31014	PORTAESTANTE ARANDELA PE4 5x16mm ZN	265
28025	PERCHA PROBADOR PER3 55x20mm IN	338	30533	CIERRE CAJA REGULABLE CC6 138-150mm ZN	291	31015	PORTAESTANTE CRISTAL PE4 5x16mm ZN	265
28026	PERCHA EMBUTIR PER9 80x20x13,5mm NS	333	30534	CIERRE CAJA C/LLAVE CC7 131x43mm NE	291	31016	PORTAESTANTE CRISTAL PE4 3x16mm ZN	265
28027	PERCHA EMBUTIR PER10 140x16x13,5mm NS	333	30535	ESCUDO BOCALLAVE ARMARIO EBA1 31mm PL	243	31017	PORTAESTANTE ARANDELA PE3 3x5x16mm ZN	265
28028	PERCHA CUADRADA PER11 43x35mm IN	337	30536	ESCUDO BOCALLAVE ARMARIO EBA1 31mm NS	243	31021	PORTAESTANTE ARANDELA PE3 5x16mm LTD (100)	265
28029	PERCHA SIMPLE PER12 79x20mm IN	336	30537	CADENA RECTA LISA CDN1 2x12,5x60mts LTD	408	31023	PORTAESTANTE ARANDELA PE3 5x16mm ZN (100)	265
28030	PERCHA SIMPLE PER12 60x20mm IN	336	30538	CADENA RECTA LISA CDN1 2,8x17,5x60mts NI	408	31111	PORTAESTANTE C/GOMA PE10 5mm LT	269
28031	PERCHA DOBLE PER14 90x20mm IN	336	30539	CADENA RECTA LISA CDN1 2x12,5x60mts BR	408	31112	PORTAESTANTE C/GOMA PE10 5mm NI	269
28032	PERCHA 2 GANCHOS PER15 185x72mm IN	337	30540	CADENA RECTA LISA CDN1 2x12,5x60mts LTD	408	31121	SOPORTE BALDA OCULTO SBO3 150mm BC	302
28150	MANILLON ROSETA L CURVA 575 150x19mm IN	9	30541	CADENA RECTA LISA CDN1 3,4x43x20mts NE	408	31122	SOPORTE BALDA OCULTO SBO3 190mm BC	302
28200	MANILLON ROSETA L CURVA 575 200x19mm IN	9	30542	CADENA RECTA LISA CDN1 3,4x43x20mts NE	408	31123	SOPORTE BALDA OCULTO SBO4 8x100mm ZN	302
28201	MANILLON ROSETA L CURVA 575 200x19mm PVD	9	30543	CADENA OVAL LISA CDN2 2,8x17,5x30mts LTD	408	31124	SOPORTE BALDA OCULTO SBO4 8x140mm ZN	302
28202	MANILLON ROSETA L CURVA 575 200x19mm NE	9	30544	CADENA OVAL LISA CDN2 2,8x17,5x30mts NE	408	31125	SOPORTE BALDA OCULTO SBO4 10x100mm ZN	302
28203	MANILLON ROSETA L CURVA 575 200x19mm BL	9	30545	CADENA RECTA TORCIDA CDN3 3,5x38x20mts LTD	408	31126	SOPORTE BALDA OCULTO SBO4 10x140mm ZN	302
28250	MANILLON ROSETA L CURVA 575 250x19mm IN	9	30546	CADENA RECTA TORCIDA CDN3 3,5x38x20mts BR	408	31127	SOPORTE BALDA OCULTO SBO4 10x170mm ZN	302
28300	MANILLON ROSETA L CURVA 575 300x19mm IN	9	30547	CADENA RECTA TORCIDA CDN3 3,5x38x20mts NE	408	31128	SOPORTE BALDA OCULTO SBO1 150mm ZN	302
28400	MANILLON ROSETA L CURVA 575 400x19mm IN	9	30548	CADENA RECTA GRABADA CDN4 4x29x20mts LTD	409	31129	SOPORTE BALDA OCULTO SBO2 150mm ZN	302
28500	MANILLON ROSETA L CURVA 575 500x19mm IN	9	30549	CADENA RECTA GRABADA CDN4 4x29x2				

NUMÉRICO

Código	Descripción	Pág.	Código	Descripción	Pág.	Código	Descripción	Pág.
31203	SOPORTE PELICANO SP4 75x65mm OR	300	33202	BISAGRA PIANO BS21 32x720mm LTD	190	38212	PLACA RECTA UNION PCL2 120x15mm ZN	312
31204	SOPORTE PELICANO SP4 75x65mm CB	300	33203	BISAGRA PIANO BS21 32x720mm LTD	190	38240	PLACA RECTA UNION PCL2 40x15mm ZN	312
31205	SOPORTE PELICANO SP4 75x65mm CM	300	33204	BISAGRA PIANO BS21 32x720mm LTD	190	38260	PLACA RECTA UNION PCL2 60x15mm ZN	312
31206	SOPORTE PELICANO SP1 28x39mm CM	301	33205	BISAGRA PIANO BS21 32x720mm LTD	190	38280	PLACA RECTA UNION PCL2 80x15mm ZN	312
31207	SOPORTE PELICANO SP2 111x70mm CM	301	33206	BISAGRA PIANO BS21 32x720mm LTD	190	39000	ANGULO REFUERZO AN1 20x20x19mm BL	308
31208	SOPORTE PELICANO SP3 111x70mm CM	301	33207	BISAGRA PIANO BS21 32x720mm LTD	190	39001	ANGULO REFUERZO AN1 30x30x19mm BL	308
31209	SOPORTE PELICANO SP8 30x46mm CM	299	33208	BISAGRA PIANO BS21 32x720mm LTD	190	39002	ANGULO REFUERZO AN1 40x40x19mm BL	308
31210	SOPORTE PELICANO SP6 77x112mm CM	299	33209	BISAGRA PIANO BS21 32x720mm LTD	190	39003	ANGULO REFUERZO AN1 50x50x19mm BL	308
31211	PORTAESTANTE REDONDO PE14 14x4x1/8mm LT	268	33210	BISAGRA PIANO BS21 32x720mm LTD	190	39004	ANGULO REFUERZO AN1 60x60x19mm BL	308
31212	PORTAESTANTE REDONDO PE14 14x4x1/8mm NI	268	33211	BISAGRA PIANO BS21 32x720mm LTD	190	39020	ANGULO REFUERZO AN1 20x20x19mm BC	308
31221	SOPORTE PELICANO SP7 110x87mm BL	300	33212	BISAGRA PIANO BS21 32x720mm LTD	190	39030	ANGULO REFUERZO AN1 30x30x19mm BC	308
31222	SOPORTE PELICANO SP7 110x87mm BL	300	33213	BISAGRA PIANO BS21 32x720mm LTD	190	39040	ANGULO REFUERZO AN1 40x40x19mm BC	308
31223	SOPORTE PELICANO SP7 110x87mm OR	300	33214	BISAGRA PIANO BS21 32x720mm LTD	190	39050	ANGULO REFUERZO AN1 50x50x19mm BC	308
31224	SOPORTE PELICANO SP7 110x87mm CM	300	33215	BISAGRA PIANO BS21 32x720mm LTD	190	39060	ANGULO REFUERZO AN1 60x60x19mm BC	308
31225	SOPORTE PELICANO SP7 110x87mm NS	300	33216	BISAGRA PIANO BS21 32x720mm LTD	190	39080	ANGULO REFUERZO AN1 80x80x19mm BC	308
31226	SOPORTE PELICANO SP7 110x87mm CU	300	33217	BISAGRA PIANO BS21 32x720mm LTD	190	39100	ANGULO REFUERZO AN1 100x100x19mm BC	308
31227	SOPORTE PELICANO SP7 110x87mm LE	300	33218	BISAGRA PIANO BS21 32x720mm LTD	190	39101	ANGULO REFUERZO AN2 20x20x15mm ZN	309
31241	SOPORTE PELICANO SP8 42x53mm BL	300	33219	BISAGRA PIANO BS21 32x720mm LTD	190	39102	ANGULO REFUERZO AN2 30x30x15mm ZN	309
31243	SOPORTE PELICANO SP8 42x53mm OR	300	33220	BISAGRA PIANO BS21 32x720mm LTD	190	39103	ANGULO REFUERZO AN2 40x40x15mm ZN	309
31245	SOPORTE PELICANO SP8 42x53mm CM	300	33221	BISAGRA PIANO BS21 32x720mm LTD	190	39104	ANGULO REFUERZO AN2 50x50x15mm ZN	309
31277	SOPORTE TV LCD STV1 17"-37" NE	220	33222	BISAGRA PIANO BS21 32x720mm LTD	190	39105	ANGULO REFUERZO AN2 60x60x15mm ZN	309
31278	SOPORTE TV LCD STV2 17"-37" NE	220	33223	BISAGRA PIANO BS21 32x720mm LTD	190	39106	ANGULO REFUERZO AN2 80x80x15mm ZN	309
31279	SOPORTE TV LCD STV3 17"-37" NE	220	33224	BISAGRA PIANO BS21 32x720mm LTD	190	39107	ANGULO REFUERZO AN2 100x100x15mm ZN	309
31280	SOPORTE TV LCD STV4 17"-47" NE	221	33225	BISAGRA PIANO BS21 32x720mm LTD	190	39108	ESCUADRA PLANA PLC5 40x40x12mm ZN	314
31281	SOPORTE TV LCD STV5 17"-55" NE	221	33226	BISAGRA PIANO BS21 32x720mm LTD	190	39109	ESCUADRA PLANA PLC5 50x50x12mm ZN	314
31282	SOPORTE TV LCD STV6 30"-63" NE	222	33227	BISAGRA PIANO BS21 32x720mm LTD	190	39110	ESCUADRA PLANA PLC5 60x60x12mm ZN	314
31283	SOPORTE TV LCD STV7 30"-70" NE	222	33228	BISAGRA PIANO BS21 32x720mm LTD	190	39111	ESCUADRA PLANA PLC5 80x80x18mm ZN	314
31284	SOPORTE TV LCD STV8 30"-63" NE	222	33229	BISAGRA PIANO BS21 32x720mm LTD	190	39112	ESCUADRA PLANA PLC5 100x100x18mm ZN	314
31285	SOPORTE TV LCD STV9 30"-70" NE	221	33230	BISAGRA PIANO BS21 32x720mm LTD	190	39113	ESCUADRA PLANA PLC5 120x120x18mm ZN	314
31311	PORTAESTANTE ESTAMPADO PE12 7mm LTD	268	33231	BISAGRA PIANO BS21 32x720mm LTD	190	39114	PLACA CUADRADA PLC6 45x45mm ZN	311
31321	CASQUILLO ESTAMPADO PE12 7mm LTD	268	33232	BISAGRA PIANO BS21 32x720mm LTD	190	39115	PLACA RECTANGULAR PLC7 70x35mm ZN	311
31401	PIVOTE SUJETA CAMPANA PVT1 ZN	350	33233	BISAGRA PIANO BS21 32x720mm LTD	190	39116	ANGULO REFUERZO AN5 20x20x40mm ZN	310
31411	PORTAESTANTE ROSCADO PE13 10x21xM6 LT	268	33234	BISAGRA PIANO BS21 32x720mm LTD	190	39117	ANGULO REFUERZO AN6 20x20x50mm ZN	310
31412	PORTAESTANTE ROSCADO PE13 10x21xM6 NI	268	33235	BISAGRA PIANO BS21 32x720mm LTD	190	39118	ANGULO REFUERZO AN7 21x21x67mm ZN	310
31421	CASQUILLO ROSCADO PE13 9x8xM6 LT	268	33236	BISAGRA PIANO BS21 32x720mm LTD	190	39119	ANGULO REFUERZO AN8 21x21x86mm ZN	310
31422	CASQUILLO ROSCADO PE13 9x8xM6 NI	268	33237	BISAGRA PIANO BS21 32x720mm LTD	190	39120	ANGULO REFUERZO AN9 40x40x90mm ZN	311
31511	PORTAESTANTE PRESION PE11 10x20mm LT	268	33238	BISAGRA PIANO BS21 32x720mm LTD	190	39121	ANGULO REFUERZO AN4 20x20x30mm ZN	309
31512	PORTAESTANTE PRESION PE11 10x20mm NI	268	33239	BISAGRA PIANO BS21 32x720mm LTD	190	39122	ANGULO REFUERZO AN4 30x30x30mm ZN	309
31521	CASQUILLO PRESION PE11 9x7,5mm LT	268	33240	BISAGRA PIANO BS21 32x720mm LTD	190	39123	ANGULO REFUERZO AN4 40x40x30mm ZN	309
31522	CASQUILLO PRESION PE11 9x7,5mm NI	268	33241	BISAGRA PIANO BS21 32x720mm LTD	190	39124	ANGULO REFUERZO AN4 50x50x30mm ZN	309
31602	PORTAESTANTE VENTOSA PE15 5mm NI	269	33242	BISAGRA PIANO BS21 32x720mm LTD	190	39125	ANGULO REFUERZO AN4 60x60x30mm ZN	309
31603	PORTAESTANTE CRISTAL PE9 5mm NI	267	33243	BISAGRA PIANO BS21 32x720mm LTD	190	39126	PLACA RECTA UNION PCL8 40x30mm ZN	311
31604	SOPORTE CRISTAL PIVOTE SC9 5mm NI	299	33244	BISAGRA PIANO BS21 32x720mm LTD	190	39127	PLACA RECTA UNION PCL8 60x30mm ZN	311
31606	PORTAESTANTE PALETA PE1 5mm NI	267	33245	BISAGRA PIANO BS21 32x720mm LTD	190	39128	PLACA RECTA UNION PCL8 80x30mm ZN	311
31607	PORTAESTANTE PERNO PE17 5mm NI	267	33246	BISAGRA PIANO BS21 32x720mm LTD	190	39129	PLACA RECTA UNION PCL8 100x30mm ZN	311
31608	PORTAESTANTE EURO PE18 5mm NI	267	33247	BISAGRA PIANO BS21 32x720mm LTD	190	39130	PLACA RECTA UNION PCL8 120x30mm ZN	311
31609	PORTAESTANTE PE2 5mm NI	265	33248	BISAGRA PIANO BS21 32x720mm LTD	190	39131	ANGULO FIJACION AN10 38x28x23mm ZN	309
31615	TORNILLO KOMBY TNE3 M6x15mm LTD	281	33249	BISAGRA PIANO BS21 32x720mm LTD	190	39132	ANGULO FIJACION AN11 28x28x30mm ZN	310
31625	TUBO UNION KOMBY TNE2 M6x8x29mm LTD	281	33250	BISAGRA PIANO BS21 32x720mm LTD	190	39133	ANGULO ANCLAJE C/TORNILLO AN19 30x36mm ZN	317
32000	COLGADOR CUADROS N°0 CG12 LTD	327	33251	BISAGRA PIANO BS21 32x720mm LTD	190	39134	PLACA PESANTE PCL9 80x50mm ZN	314
32001	COLGADOR CUADROS N°1 CG12 LTD	327	33252	BISAGRA PIANO BS21 32x720mm LTD	190	39135	PLACA PESANTE PCL9 120x50mm ZN	314
32002	COLGADOR CUADROS N°2 CG12 LTD	327	33253	BISAGRA PIANO BS21 32x720mm LTD	190	39136	PLACA PESANTE PCL9 160x50mm ZN	314
32003	COLGADOR CUADROS TELA ENGOMADA CG18 BL	327	33254	BISAGRA PIANO BS21 32x720mm LTD	190	39137	PLACA PESANTE PCL9 200x50mm ZN	314
32006	COLGADOR CUADROS DENTADO CG19 LTD	327	33255	BISAGRA PIANO BS21 32x720mm LTD	190	39138	ANGULO PESANTE AN13 40x40x50mm ZN	315
32100	GANCHO X N°0 CG13 LTD	327	33256	BISAGRA PIANO BS21 32x720mm LTD	190	39139	ANGULO PESANTE AN13 60x60x50mm ZN	315
32101	GANCHO X N°1 CG13 LTD	327	33257	BISAGRA PIANO BS21 32x720mm LTD	190	39140	ANGULO PESANTE AN13 80x80x50mm ZN	315
32102	GANCHO X N°2 CG13 LTD	327	33258	BISAGRA PIANO BS21 32x720mm LTD	190	39141	ANGULO PESANTE AN13 100x100x50mm ZN	315
32501	SOPORTE MEDIA LUNA SC6 5-6mm OR	298	33259	BISAGRA PIANO BS21 32x720mm LTD	190	39142	ANGULO PESANTE AN15 60x60x50mm ZN	316
32502	SOPORTE MEDIA LUNA SC6 5-6mm CB	298	33260	BISAGRA PIANO BS21 32x720mm LTD	190	39143	ANGULO PESANTE AN16 85x85x55mm ZN	316
32503	SOPORTE MEDIA LUNA SC6 5-6mm CM	298	33261	BISAGRA PIANO BS21 32x720mm LTD	190	39144	ANGULO PESANTE AN17 100x100x90mm ZN	316
32504	SOPORTE MEDIA LUNA SC6 5-6mm BL	298	33262	BISAGRA PIANO BS21 32x720mm LTD	190	39145	ANGULO PESANTE 135° AN18 80x80x50mm ZN	316
32506	JGO BISAGRA CRISTAL BSC21 LTD	185	33263	BISAGRA PIANO BS21 32x720mm LTD	190	39146	PLACA FORMA T PCL11 160x45x100mm ZN	317
32507	JGO BISAGRA CRISTAL BSC21 CB	185	33264	BISAGRA PIANO BS21 32x720mm LTD	190	39147	PLACA C/TUERCA PCL12 M8x50x50mm ZN	317
32508	JGO BISAGRA CRISTAL BSC21 NE	185	33265	BISAGRA PIANO BS21 32x720mm LTD	190	39148	PLACA C/TUERCA PCL12 M10x50x50mm ZN	317
32509	JGO BISAGRA CRISTAL BSC21 NS	185	33266	BISAGRA PIANO BS21 32x720mm LTD	190	39149	ANGULO PESANTE AN12 40x40x20mm ZN	315
32510	JGO BISAGRA CRISTAL BSC22 NI	185	33267	BISAGRA PIANO BS21 32x720mm LTD	190	39150	ANGULO PESANTE AN12 40x40x40mm ZN	315
32511	SOPORTE MEDIA LUNA SC6 8-10mm OR	298	33268	BISAGRA PIANO BS21 32x720mm LTD	190	39151	ANGULO PESANTE AN12 50x50x40mm ZN	315
32512	SOPORTE MEDIA LUNA SC6 8-10mm CB	298	33269	BISAGRA PIANO BS21 32x720mm LTD	190	39152	ANGULO PESANTE AN14 60x60x40mm ZN	315
32513	SOPORTE MEDIA LUNA SC6 8-10mm CM	298	33270	BISAGRA PIANO BS21 32x720mm LTD	190	39153	ANGULO PESANTE AN14 60x60x60mm ZN	315
32514	SOPORTE MEDIA LUNA SC6 8-10mm BL	298	33271	BISAGRA PIANO BS21 32x720mm LTD	190	39154	ANGULO PESANTE AN14 60x60x80mm ZN	315
32516	SEPARADOR CRISTAL SC8 12x25mm IN	297	33272	BISAGRA PIANO BS21 32x720mm LTD	190	39155	ANGULO PESANTE AN14 80x80x80mm ZN	315
32517	SEPARADOR CRISTAL SC8 15x50mm IN	297	33273	BISAGRA PIANO BS21 32x720mm LTD	190	39156	PLACA RECTA PERFORADA PCL10 160x40mm ZN	314
32518	SEPARADOR CRISTAL SC8 18x75mm IN	297	33274	BISAGRA PIANO BS21 32x720mm LTD	190	39157	PLACA RECTA PERFORADA PCL10 200x60mm ZN	314
32519	SEPARADOR CRISTAL SC8 20x100mm IN	297	33275	BISAGRA PIANO BS21 32x720mm LTD	190	39158	PLACA RECTA PERFORADA PCL10 240x80mm ZN	314
32520	JGO BISAGRA CRISTAL BSC23 CB	185	33276	BISAGRA PIANO BS21 32x720mm LTD	190	39159	SOPORTE VIGA ABIERTO SV2 70x125mm ZN	318
32601	SOPORTE ESFERICO SC5 5-6mm OR*	298	33277	BISAGRA PIANO BS21 32x720mm LTD	190	39160	SOPORTE VIGA CERRADO SV3 70x125mm ZN	318
32602	SOPORTE ESFERICO SC5 5-6mm CB	298	33278	BISAGRA PIANO BS21 32x720mm LTD	190	39161	SOPORTE VIGA ABIERTO SV2 80x120mm ZN	318
32603	SOPORTE ESFERICO SC5 5-6mm CM*	298	33279	BISAGRA PIANO BS21 32x720mm LTD	190	39162	SOPORTE VIGA CERRADO SV3 80x120mm ZN	318
32604	SOPORTE ESFERICO SC5 5-6mm BL	298	33280	BISAGRA PIANO BS21 32x720mm LTD	190	39163	SOPORTE VIGA ABIERTO SV2 100x140mm ZN	318
32605	SOPORTE ESFERICO SC5 5-6mm NE*	298	33281	BISAGRA PIANO BS21 32x720mm LTD	190	39164	SOPORTE VIGA CERRADO SV3 100x140mm ZN	318
32615	TORNILLO KOMBY TNE3 M6x15mm NI	281	33282	BISAGRA PIANO BS21 32x720mm LTD	190	39166	SOPORTE VIGA PIE SV4 71x17mm ZN	319
32616	TORNILLO KOMBY TNE3 M6x20mm NI	281	33283	BISAGRA PIANO BS21 32x720mm LTD	190	39167	SOPORTE VIGA PIE SV4 91x91mm ZN	319
32617	TORNILLO KOMBY TNE3 M6x25mm NI	281	33284	BISAGRA PIANO BS21 32x720mm LTD	190	39169	SOPORTE VIGA PIE SV4 121x121mm ZN	319
32618	TORNILLO KOMBY TNE3 M6x30mm NI	281	33285	BISAGRA PIANO BS21 32x720mm LTD	190	39173	SOPORTE VIGA CLAVAR SV5 70x70mm ZN*	319
32619	TORNILLO KOMBY TNE3 M6x35mm NI	281	33286	BISAGRA PIANO BS21 32x720mm LTD	190	39174	SOPORTE VIGA CLAVAR SV5 90x90mm ZN*	319
32620	TORNILLO KOMBY TNE3 M6x40mm NI	281	33287	BISAGRA PIANO BS21 32x720mm LTD	190	39175	SOPORTE VIGA INCLINADO SV1 70x70x80mm ZN	318
32621	TORNILLO KOMBY TNE3 M6x50mm NI	281	33288	BISAGRA PIANO BS21 32x720mm LTD	190	39176	SOPORTE VIGA INCLINADO SV1 90x90x95mm ZN	318
32622	TORNILLO KOMBY TNE3 M6x60mm NI	281	33289	BISAGRA PIANO BS21 32x720mm LTD	190	39177	SOPORTE POSTE REDONDO SV6 80-100mm ZN	320
32623	JGO TORNILLO UNION KOMBY TNE5 M4 NI	281	33290	BISAGRA PIANO BS21 32x720mm LTD	190	39178	SOPORTE POSTE REDONDO SV7 80-100mm ZN	320
32624	TORNILLO UNION TNE11 4x27mm NI	280	33291	BISAGRA PIANO BS21 32x720mm LTD	190	39179	SOPORTE POSTE SUELO SV8 80mm ZN	319
32625	TUBO UNION KOMBY TNE2 M6x8x29mm NI	281	33292	BISAGRA PIANO BS21 32x720mm LTD	190	39180	SOPORTE POSTE SUELO SV8 100mm ZN	319
32626	TORNILLO UNION TNE11 4x31mm NI	280	33293	BISAGRA PIANO BS21 32x720mm LTD	190	39181	SOPORTE POSTE SUELO SV8 120mm ZN*	319
32701	SOPORTE CILINDRICO SC4 5-6mm OR	298	33294	BISAGRA PIANO BS21 32x720mm LTD	190	39182	SOPORTE POSTE CLAVAR SV9 100mm ZN*	319
32702	SOPORTE CILINDRICO SC4 5-6mm CB	298	33295	BISAGRA PIANO BS21 32x720mm LTD	190	39183	SOPORTE POSTE CLAVAR SV9 100mm ZN*	319
32703	SOPORTE CILINDRICO SC4 5-6mm CM	298	33296	BISAGRA PIANO BS21 32x720mm LTD	190	39184	SOPORTE RIEL CT4 120x70mm ZN	238
32704	SOPORTE CILINDRICO SC4 5-6mm BL	298	33297	BISAGRA PIANO BS21 32x720mm LTD	190	39500	COLGADOR ESCUADRA TRIANGULO CG7 ZN	325
32712	SOPORTE CILINDRICO SC4 8-10mm CB	298	33298	BISAGRA PIANO BS21 32x720mm LTD	190	39501	PLACA COLGADOR CG2 50x50mm ZN	322
32713	SOPORTE CILINDRICO SC4 8-10mm CM	298	33299	BISAGRA PIANO BS21 32x720mm LTD	190	39502	PLACA COLGADOR EXTINTOR CG14 6kgs ZN	326
33010	PALOMILLA ORNAMENTAL PLM5 100x90mm							

NUMÉRICO

Código	Descripción	Pág.	Código	Descripción	Pág.	Código	Descripción	Pág.
39507	PLACA COLGADOR EXTINTOR CG15 5kgs ZN	326	44138	BL PASADOR ZAMAK PS2 35mm LE*	133	49102	TUERCA CIEGA TRC1 M10x13x12mm NI	294
39511	GANCHO COLGADOR CG1 70x15mm ZN	322	44139	BL PASADOR ZAMAK PS2 35mm NE*	133	50041	BL PALOMILLA ALUMINIO PLM8 150mm BL	304
39521	COLGADOR ESCUADRA DERECHA CG3 ZN	323	44145	BL PASADOR ZAMAK PS2 45mm LTD	133	50042	BL PALOMILLA ALUMINIO PLM8 200mm BL	304
39522	COLGADOR ESCUADRA IZQUIERDA CG3 ZN	323	44146	PASADOR FORJA PS11 40mm NE	133	50043	BL PALOMILLA ALUMINIO PLM8 250mm BL	304
39531	COLGADOR ESCUADRA REGULABLE CG6 ZN	324	44147	PASADOR FORJA PS11 50mm NE	133	50044	BL PALOMILLA ALUMINIO PLM8 300mm BL	304
39541	COLGADOR BIVALENTE CG4 59x49mm BL	323	44235	BL PASADOR ZAMAK PS2 35mm NI	133	50045	BL PALOMILLA ALUMINIO PLM8 350mm BL	304
39542	COLGADOR BIVALENTE CG4 59x49mm BE	323	44245	BL PASADOR ZAMAK PS2 45mm NI	133	50046	BL PALOMILLA ALUMINIO PLM8 400mm BL	304
39551	PLACA COLGADOR DOBLE CG21 130x30mm ZN	324	44246	BL PASADOR ZAMAK PS2 45mm NS	133	50047	BL PALOMILLA ALUMINIO PLM8 150mm PL	304
39552	PLACA COLGADOR TIRA CG20 2mts ZN	324	44330	PASADOR HIERRO PS1 30mm LTD	134	50048	BL PALOMILLA ALUMINIO PLM8 200mm PL	304
39561	JGO COLGADOR COCINA OCULTO CG5 ZN	324	44335	PASADOR HIERRO PS1 35mm LTD	134	50049	BL PALOMILLA ALUMINIO PLM8 250mm PL	304
40001	TUERCA ENSAMBLE TNE9 13x11x1/4 LT	280	44340	PASADOR HIERRO PS1 40mm LTD	134	50050	BL PALOMILLA ALUMINIO PLM8 300mm PL	304
40002	TUERCA ENSAMBLE TNE9 13x11x1/4 NI	280	44350	PASADOR HIERRO PS1 50mm LTD	134	50051	BL PALOMILLA ALUMINIO PLM8 350mm PL	304
40030	ESPARRAGO TNE10 1/4x30mm ZN	280	44360	PASADOR HIERRO PS1 60mm LTD	134	50052	BL PALOMILLA ALUMINIO PLM8 400mm PL	304
40061	VARILLA HUECA VR1 M10/100x20mm ZN	294	44510	PASADOR HIERRO PS1 100mm NI	134	50225	ALZAPANO TORNEADO PER19 25mm LT	333
40062	VARILLA HUECA VR1 M10/100x40mm ZN	294	44530	PASADOR HIERRO PS1 30mm NI	134	50325	GANCHO FORMA S CG23 25mm ZN	328
40063	VARILLA HUECA VR1 M10/100x100mm ZN	294	44535	PASADOR HIERRO PS1 35mm NI	134	50330	GANCHO FORMA S CG23 30mm ZN	328
40064	VARILLA HUECA VR1 M10/100x1mt ZN	294	44540	PASADOR HIERRO PS1 40mm NI	134	50335	GANCHO FORMA S CG23 35mm ZN	328
40065	TUERCA TRC9 M10/100x13x4mm ZN	294	44550	PASADOR HIERRO PS1 50mm NI	134	50340	GANCHO FORMA S CG23 40mm ZN	328
40101	TORNILLO PASANTE TRN1 M3x55mm LTD	117	44560	PASADOR HIERRO PS1 60mm NI	134	50350	GANCHO FORMA S CG23 50mm ZN	328
40102	TORNILLO PASANTE TRN1 M3x55mm NS	117	44570	PASADOR HIERRO PS1 70mm NI	134	50360	GANCHO FORMA S CG23 60mm ZN	328
40103	TORNILLO PASANTE CABINA CB22 IN	158	44585	PASADOR HIERRO PS1 85mm NI	134	50370	GANCHO FORMA S CG23 70mm ZN	328
40104	TORNILLO PASANTE CABINA CB23 IN	158	44633	PASADOR ZAMAK PS3 35mm BL	133	50380	GANCHO FORMA S CG23 80mm ZN	328
40105	TORNILLO PASANTE MULTICORTE TRN2 M4x75mm LTD	117	44634	PASADOR ZAMAK PS3 50mm BL	133	50540	TIRADOR ARMARIO S/B 505 CU	24
40106	TORNILLO PASANTE MULTICORTE TRN2 M4x75mm NS	117	44635	PASADOR ZAMAK PS3 35mm LTD	133	50543	TIRADOR MALETERO 505 CU	24
40107	TORNILLO CABINA CB25 3,5x14mm IN	158	44650	PASADOR ZAMAK PS3 50mm LTD	133	50546	MANILLON PLACA 505 CU	24
40108	TORNILLO PASANTE TUBO TRN3 M3x60mm ZN	117	44735	PASADOR ZAMAK PS3 35mm CB	133	51100	CREMALLERA ALUMINIO PLM8 1mt BL	304
40109	TORNILLO PASANTE TUBO TRN3 M4x75mm ZN	117	44750	PASADOR ZAMAK PS3 50mm CB	133	51150	CREMALLERA ALUMINIO PLM8 1,5mts BL	304
40110	TORNILLO PASANTE CABINA CB24 IN	158	44830	TORNILLO ANCLAJE TRN6 M6x30mm BC	282	51200	CREMALLERA ALUMINIO PLM8 2mts BL	304
40111	TORNILLO CABINA CB25 3,5x12,5mm IN	158	44910	PASADOR PORTACANDADO PS12 100mm BC	136	51401	ALDABA CLASICA DCHA ADB1 40mm NI	131
40250	JGO MANILLON CURVA MN1 250x25mm IN	95	44912	PASADOR PORTACANDADO PS12 120mm BC	136	51402	ALDABA CLASICA IZDA ADB1 40mm NI	131
40300	JGO MANILLON CURVA MN1 300x25mm IN	95	44970	PASADOR PORTACANDADO PS12 70mm BC	136	51601	ALDABA CLASICA DCHA ADB1 60mm NI	131
41018	GALLETA MADERA ENS9 N°0	284	44985	PASADOR PORTACANDADO PS12 85mm BC	136	51602	ALDABA CLASICA IZDA ADB1 60mm NI	131
41019	GALLETA MADERA ENS9 N°10	284	44986	PORTACANDADO CC10 75mm ZN	135	51801	ALDABA CLASICA DCHA ADB1 80mm NI	131
41020	GALLETA MADERA ENS9 N°20	284	44987	PORTACANDADO CC10 100mm ZN	135	51802	ALDABA CLASICA IZDA ADB1 80mm NI	131
41021	ESPIGA METALICA ENS9 3,3x37mm ZN/VE	284	44988	PORTACANDADO CC10 120mm ZN	135	51803	ALDABILLA RETENIDA ADB3 3x40mm ZN	132
41035	ESPIGA MADERA ENS5 10x35mm	285	44989	PORTACANDADO CC10 150mm ZN	135	51804	ALDABILLA RETENIDA ADB3 3,5x60mm ZN	132
41040	ESPIGA MADERA ENS5 10x40mm	285	44990	PORTACANDADO CC10 75mm NE	135	51805	ALDABILLA RETENIDA ADB3 4x80mm ZN	132
41060	VARILLA MADERA ESTRIADA ENS6 6x1mt	285	44991	PORTACANDADO CC10 100mm NE	135	51806	ALDABILLA RETENIDA ADB3 4x100mm ZN	132
41080	VARILLA MADERA ESTRIADA ENS6 8x1mt	285	44992	PORTACANDADO CC10 120mm NE	135	51807	ALDABILLA RETENIDA ADB3 4,5x120mm ZN	132
41100	VARILLA MADERA ESTRIADA ENS6 10x1mt	285	44993	PORTACANDADO CC10 150mm NE	135	51808	ALDABA BARCO ADB2 75mm LP	132
41120	VARILLA MADERA ESTRIADA ENS6 12x1mt	285	45121	EMBELLECEDOR LISO SC1 12mm LT	296	51809	ALDABA BARCO ADB2 100mm LP	132
41140	VARILLA MADERA ESTRIADA ENS6 14x1mt	285	45122	EMBELLECEDOR LISO SC1 12mm NI	296	51810	ALDABA BARCO ADB2 125mm LP	132
41141	VARILLA MADERA LISA ENS7 5x0,8mts	285	45141	EMBELLECEDOR LISO SC1 14mm LT	296	51811	ALDABA BARCO ADB2 75mm NS	132
41142	VARILLA MADERA ESTRIADA ENS6 18x1mt	285	45142	EMBELLECEDOR LISO SC1 14mm NI	296	51812	ALDABA BARCO ADB2 100mm NS	132
41143	VARILLA MADERA ESTRIADA ENS6 20x1mt	285	45161	EMBELLECEDOR LISO SC1 16mm LT	296	51813	ALDABA BARCO ADB2 125mm NS	132
41160	VARILLA MADERA ESTRIADA ENS6 16x1mt	285	45162	EMBELLECEDOR LISO SC1 16mm NI	296	51814	ALDABA BARCO ADB2 100mm NE	132
41161	VARILLA MADERA LISA ENS7 6x1mt	285	45181	EMBELLECEDOR LISO SC1 18mm LT	296	51815	ALDABA BARCO ADB2 150mm NE	132
41162	VARILLA MADERA LISA ENS7 8x1mt	285	45182	EMBELLECEDOR LISO SC1 18mm NI	296	51816	ALDABA BARCO ADB2 200mm NE	132
41163	VARILLA MADERA LISA ENS7 10x1mt	285	46121	EMBELLECEDOR FACETADO SC2 12mm LT	296	51817	ALDABA REVERSIBLE PEQUEÑA ADB3 IN	130
41164	VARILLA MADERA LISA ENS7 12x1mt	285	46122	EMBELLECEDOR FACETADO SC2 12mm NI	296	51818	ALDABA REVERSIBLE GRANDE ADB6 IN	130
41165	VARILLA MADERA LISA ENS7 14x1mt	285	46141	EMBELLECEDOR FACETADO SC2 14mm LT	296	51819	CIERRE PRESION PEQUEÑO CP1 IN	130
41166	VARILLA MADERA LISA ENS7 16x1mt	285	46142	EMBELLECEDOR FACETADO SC2 14mm NI	296	51820	CIERRE PRESION GRANDE CP1 IN	130
41167	VARILLA MADERA LISA ENS7 18x1mt	285	46161	EMBELLECEDOR FACETADO SC2 16mm LT	296	51821	CIERRE PRESION CUADRADO CP2 IN	130
41168	VARILLA MADERA LISA ENS7 20x1mt	285	46162	EMBELLECEDOR FACETADO SC2 16mm NI	296	51822	CIERRE PRESION CUCHARA CP3 LP	130
41169	VARILLA MADERA LISA ENS7 25x1mt	285	46181	EMBELLECEDOR FACETADO SC2 18mm LT	296	51823	CIERRE PRESION CUCHARA CP2 NS	130
41240	ESPIGA MADERA ENS5 12x40mm	285	46182	EMBELLECEDOR FACETADO SC2 18mm NI	296	51824	ALDABA CUÑA ADB7 60mm NS	132
41250	JGO MANILLON RECTO MN2 250x25mm IN	95	46300	ESPIGA MADERA ENS5 6x30mm	285	51825	ALDABA CUÑA ADB7 60mm LS	132
41300	JGO MANILLON RECTO MN2 300x25mm IN	95	46350	ESPIGA MADERA ENS5 6x35mm	285	51826	ALDABA CUÑA ADB7 60mm NE	132
41401	MANILLA CREMONA 414 LP	43	46400	ESPIGA MADERA ENS5 6x40mm	285	52100	CREMALLERA ALUMINIO PLM8 1mt PL	304
41402	MANILLA CREMONA 414 NS	43	47011	SUJETALUNAS LISO SC3 2-6mm LT	297	52150	CREMALLERA ALUMINIO PLM8 1,5mts PL	304
41403	VARILLA CREMONA 1/2 CAÑA 414 1,5mts LP	43	47012	SUJETALUNAS LISO SC3 2-6mm NI	297	52200	CREMALLERA ALUMINIO PLM8 2mts PL	304
41404	VARILLA CREMONA 1/2 CAÑA 414 1,5mts NS	43	47111	SUJETALUNAS LISO SC3 5-8mm LT	297	52401	ALDABA CLASICA DCHA ADB1 40mm LTD	131
41425	JGO MANILLON RECTO MN2 425x25mm IN	95	47112	SUJETALUNAS LISO SC3 5-8mm NI	297	52402	ALDABA CLASICA IZDA ADB1 40mm LTD	131
41440	ESPIGA MADERA ENS5 14x60mm*	285	48001	KIT PUERTA CORREDERA PCR3 35mm LTD	170	52601	ALDABA CLASICA DCHA ADB1 60mm LTD	131
41460	ESPIGA MADERA ENS5 14x60mm*	285	48002	KIT PUERTA CORREDERA PCR3 35mm NS	170	52602	ALDABA CLASICA IZDA ADB1 60mm LTD	131
42300	JGO MANILLON RECTO MN3 300x30mm IN	95	48003	KIT PUERTA CORREDERA PCR3 35mm CU	170	52801	ALDABA CLASICA DCHA ADB1 80mm LTD	131
42350	JGO MANILLON RECTO MN3 350x30mm IN	95	48008	KIT PUERTA CORREDERA PCR3 35mm NE	170	52802	ALDABA CLASICA IZDA ADB1 80mm LTD	131
42450	JGO MANILLON RECTO MN3 450x30mm IN	95	48011	SUJETALUNAS FACETADO SC3 2-6mm LT	297	54501	MULETILLA ROSETA C/INDICADOR CB1 IN	152
42600	JGO MANILLON RECTO MN3 600x30mm IN	95	48012	SUJETALUNAS FACETADO SC3 2-6mm NI	297	54502	BISAGRA PLANA S/MUELLE CB2 IN	153
42900	JGO MANILLON RECTO MN3 900x30mm IN	95	48101	TIRADOR EMBUTIR TE1 45mm LP	209	54503	BISAGRA PLANA C/MUELLE CB3 IN	153
43001	ANCLAJE PRECERCO V PRC1 30x30mm NE	118	48102	TIRADOR EMBUTIR TE1 45mm NS	209	54504	JGO POMOS CB4 25mm IN	152
43002	GARRA PRECERCO PRC2 140x20mm ZN	118	48103	TIRADOR EMBUTIR TE1 45mm CU	209	54505	SOPORTE TUBO PARED CB5 IN	155
43003	GARRA PRECERCO PRC3 85x17,5mm ZN	118	48108	TIRADOR EMBUTIR TE1 45mm NE	209	54506	NUDO CONECTOR TUBO CB6 90° IN	155
43158	TORNILLO SILLA TRN10 3/16x15mm NI	283	48111	SUJETALUNAS FACETADO SC3 5-8mm LT	297	54507	PINZA UNION TUBO PANEL CB7 IN	154
43159	TORNILLO SILLA TRN10 3/16x20mm NI	283	48112	SUJETALUNAS FACETADO SC3 5-8mm NI	297	54508	ESCUADRA UNION PANEL 90° CB8 IN	156
43160	TORNILLO SILLA TRN10 3/16x25mm NI	283	48201	TIRADOR EMBUTIR UNERO TE2 19mm LP	208	54509	TUBO CABINA CB9 25x2mts IN	155
43161	TORNILLO SILLA TRN10 3/16x30mm NI	283	48202	TIRADOR EMBUTIR UNERO TE2 19mm NS	208	54510	PATA REGULABLE CB10 110/180mm IN	154
43162	TORNILLO SILLA TRN10 3/16x35mm NI	283	48203	TIRADOR EMBUTIR UNERO TE2 19mm CU	208	54511	NUDO CONECTOR TUBO CB6 180° IN	155
43163	TORNILLO SILLA TRN10 3/16x40mm NI	283	48208	TIRADOR EMBUTIR UNERO TE2 19mm NE	208	54512	PINZA UNION LATERAL CB12 IN	156
43164	TORNILLO SILLA TRN10 3/16x45mm NI	283	48300	ESPIGA MADERA ENS5 8x30mm	285	54513	PERCHA TOPE GOMA PER18 50x70mm IN	154
43165	TORNILLO SILLA TRN10 3/16x50mm NI	283	48350	ESPIGA MADERA ENS5 8x35mm	285	54514	PERFIL L INTERIOR CB13 20x1800mm IN	157
43166	TORNILLO SILLA TRN10 3/16x60mm NI	283	48400	ESPIGA MADERA ENS5 8x40mm	285	54515	PERFIL L EXTERIOR CB14 33x1800mm IN	157
43167	TORNILLO SILLA TRN10 3/16x70mm NI	283	48401	KIT PUERTA CORREDERA BOCA PCR5 LTD	171	54516	PERFIL U ARRANQUE CB15 1800mm IN	157
43510	CUÑA NIVELADORA NV11 100x20x8mm MA	287	48402	KIT PUERTA CORREDERA BOCA PCR5 NS	171	54517	PINZA ESCUADRA UNION TU CB17 IN	156
43511	CUÑA NIVELADORA NV14 60x30x7mm TR	287	48403	KIT PUERTA CORREDERA BOCA PCR5 CU	171	54518	PINZA ESCUADRA UNION LU CB18 IN	156
43516	TORNILLO BISAGRA TRN5 3,5x16mm NI	196	48501	KIT PUERTA CORREDERA CUADRADO PCR4 LTD	171	54519	TUBO CABINA CB9 25x3mts IN	155
43575	CUÑA DE MADERA PRC4 75x35mm	118	48502	KIT PUERTA CORREDERA CUADRADO PCR4 NS	171	54520	EMPALME UNION TUBO CB20 IN	155
43576	CUÑA DE MADERA PRC4 250x40x30mm	118	48601	TIRADOR EMBUTIR CUADRADO TE3 LP	208	54521	KIT CABINA CORREDERA CB21 IN	158
44016	TORNILLO BISAGRA TRN5 4,0x16mm NI	196	48602	TIRADOR EMBUTIR CUADRADO TE3 NS	208	54522	MULETILLA CORREDERA CB21 IN	152
44020	PASADOR SEGURIDAD PS6 200mm BC	136	48701	TIRADOR EMBUTIR UNERO CUADRADO TE4 LP	208	54523	GUIA INFERIOR CORREDERA CB21 IN	158
44025	PASADOR SEGURIDAD PS6 250mm BC	136	48702	TIRADOR EMBUTIR UNERO CUADRADO TE4 NS	208	54524	PERFIL SUPERIOR CABINA CB19 3950mm AL	157
44030	PASADOR SEGURIDAD PS6 300mm BC	136	49041	TUERCA CIEGA TRC1 M4x7x6,5mm LT	294	54525	PERFIL U ARRANQUE CB15 1800mm AL	157
44040	PASADOR SEGURIDAD PS6 400mm BC	136	49042	TUERCA CIEGA TRC1 M4x7x6,5mm NI	294	54526	BISAGRA PLANA C/MUELLE CB26 IN	153
44050	PASADOR SEGURIDAD PS6 500mm BC	136	49051	TUERCA CIEGA TRC1 M5x8x7mm LT	294	54527	BISAGRA PARED-CRISTAL BSC1 180° EI	159
44060	PASADOR SEGURIDAD PS6 600mm BC	136	49052	TUERCA CIEGA TRC1 M5x8x7mm NI	294	54528	BISAGRA PARED-CRISTAL BSC1 180° NE	159
44133	PASADOR RULETA PS4 40mm LTD	134	49061	TUERCA CIEGA TRC1 M6x10x8mm LT	294	54529	CERRADURA CRISTAL "U" S/CILINDRO CCR1 IN	159
44134	PASADOR RULETA PS4 40mm CB	134	49062	TUERCA CIEGA TRC1 M6x10x8mm NI	294	54530	CERRADURA CRISTAL "U" S/CILINDRO CCR1 NE	159
44135	BL PASADOR ZAMAK PS2 35mm LTD	133	49081	TUERCA CIEGA TRC1 M8x12x10mm LT	294	54531	CERRADERO CRISTAL CCR2 IN	159
44136	BL PASADOR ZAMAK PS2 35mm NS	133	49082	TUERCA CIEGA TRC1 M8x12x10mm NI	294	54532	CERRADERO CRISTAL CCR2 NE	159
44137	BL PASADOR ZAMAK PS2 35mm CU*	133	49101	TUERCA CIEGA TRC1 M10x13x12mm LT	294	54533	PICAPORTE CRISTAL "U" CCR3 IN	159

ÍNDICE DE PRODUCTOS

NUMÉRICO

Código	Descripción	Pág.	Código	Descripción	Pág.	Código	Descripción	Pág.
54534	PICAPORTE CRISTAL "U" CCR3 NE	159	57218	BL CIERRAPUERTAS S/RETENEDOR MC1-S NE	173	60550	FIELTRO ADHESIVO DZ7 20mm MA	288
54535	JGO OJO DE BUEY OB1 IN	96	57219	BL CIERRAPUERTAS C/RETENEDOR MC1-C PL	173	60551	FIELTRO ADHESIVO DZ7 22mm MA	288
54536	BISAGRA MAMPARA FIJA BSC2 IN	160	57301	RETENEDOR PIE PEQ RT3 130x25mm BL	128	60552	FIELTRO ADHESIVO DZ7 26mm MA	288
54537	BISAGRA MAMPARA 90° S/ACCION BSC3 IN	160	57302	RETENEDOR PIE PEQ RT3 130x25mm NE	128	60553	FIELTRO ADHESIVO DZ7 28mm MA	288
54538	BISAGRA MAMPARA 90° D/ACCION BSC4 IN	160	57303	RETENEDOR PIE PEQ RT3 130x25mm OR	128	60554	FIELTRO ADHESIVO DZ7 34mm MA	288
54539	BISAGRA MAMPARA 90° D/ACCION BSC5 IN	160	57304	RETENEDOR PIE PEQ RT3 130x25mm PL	128	60555	FIELTRO ADHESIVO DZ7 16mm BL	288
54540	BISAGRA MAMPARA 135° D/ACCION BSC6 IN	161	57311	RETENEDOR PIE GDE RT3 180x30mm BL	128	60556	FIELTRO ADHESIVO DZ7 20mm BL	288
54541	BISAGRA MAMPARA 180° D/ACCION BSC7 IN	161	57312	RETENEDOR PIE GDE RT3 180x30mm NE	128	60557	FIELTRO ADHESIVO DZ7 22mm BL	288
54542	JGO TIRADOR EMBUTIR MAMPARA BSC8 IN	163	57313	RETENEDOR PIE GDE RT3 180x30mm OR	128	60558	FIELTRO ADHESIVO DZ7 26mm BL	288
54543	ANGULO CONECTOR TUBO MAMPARA BSC20 IN	162	57314	RETENEDOR PIE GDE RT3 180x30mm PL	128	60559	FIELTRO ADHESIVO DZ7 28mm BL	288
54544	TUBO MAMPARA EXTENSIBLE BSC10 600-800mm IN	162	58180	BISAGRA SEGURIDAD C/R CR BS15 150x80mm LTD	176	60560	FIELTRO ADHESIVO DZ7 34mm BL	288
54545	TUBO MAMPARA EXTENSIBLE BSC10 800-1000mm IN	162	58181	BISAGRA SEGURIDAD C/R CR BS15 150x80mm CU	176	60561	FIELTRO ADHESIVO DZ8 17x17mm MA	289
54546	SOPORTE TUBO MAMPARA BSC11 IN	162	58183	BISAGRA SEGURIDAD C/R CR BS15 150x80mm NE	176	60562	FIELTRO ADHESIVO DZ8 22x22mm MA	289
54547	BISAGRA MAMPARA FIJA BSC2 CB	160	58184	BISAGRA SEGURIDAD C/R CR BS15 150x80mm NS	176	60563	FIELTRO ADHESIVO DZ8 25x25mm MA	289
54548	BISAGRA MAMPARA 90° S/ACCION BSC3 CB	160	58185	BISAGRA SEGURIDAD C/R CR BS15 150x80mm PE*	176	60564	FIELTRO ADHESIVO DZ8 30x30mm MA	289
54549	BISAGRA MAMPARA 90° D/ACCION BSC4 CB	160	58186	BISAGRA SEGURIDAD S/R CR BS16 150x80mm IN	176	60565	FIELTRO ADHESIVO DZ8 100x100mm MA	289
54550	BISAGRA MAMPARA 90° D/ACCION BSC5 CB	160	58187	BISAGRA SEGURIDAD S/R CR BS16 150x80mm NS	176	60566	FIELTRO ADHESIVO DZ8 50x100mm MA	289
54551	BISAGRA MAMPARA 135° D/ACCION BSC6 CB	161	59180	BISAGRA SEGURIDAD C/R CC BS15 150x80mm LTD	176	60567	FIELTRO ADHESIVO DZ8 17x17mm BL	289
54552	BISAGRA MAMPARA 180° D/ACCION BSC7 CB	161	59181	BISAGRA SEGURIDAD C/R CC BS15 150x80mm CU	176	60568	FIELTRO ADHESIVO DZ8 22x22mm BL	289
54553	JGO POMO MAMPARA BSC12 CB	163	59183	BISAGRA SEGURIDAD C/R CC BS15 150x80mm NE	176	60569	FIELTRO ADHESIVO DZ8 25x25mm BL	289
54554	JGO POMO MAMPARA BSC13 CB	163	59184	BISAGRA SEGURIDAD C/R CC BS15 150x80mm NS	176	60570	FIELTRO ADHESIVO DZ8 30x30mm BL	289
54555	JGO POMO MAMPARA BSC14 CB	163	59185	BISAGRA SEGURIDAD C/R CC BS15 150x80mm PE*	176	60571	FIELTRO ADHESIVO DZ8 100x100mm BL	289
54556	PINZA MAMPARA PARED-CRISTAL BSC15 IN	161	59186	BISAGRA SEGURIDAD S/R CC BS16 150x80mm IN	176	60572	FIELTRO ADHESIVO DZ8 50x100mm BL	289
54557	ANGULO MAMPARA 90° PARED-CRISTAL BSC16 IN	161	59187	BISAGRA SEGURIDAD S/R CC BS16 150x80mm NS	176	60573	FIELTRO ADHESIVO DZ8 85x100mm MA	289
54558	ANGULO MAMPARA 90° CRISTAL-CRISTAL BSC17 IN	161	59516	MANILLON ROSETA 595 IN	13	60574	FIELTRO ADHESIVO DZ8 85x100mm BL	289
54559	ANGULO MAMPARA 135° CRISTAL-CRISTAL BSC19 IN	162	60001	TAPON PLASTICO P/TORNILLO TPN5 5mm BL	262	60575	FIELTRO ADHESIVO DZ9 85x1mm MA	288
54560	PINZA MAMPARA PARED-CRISTAL BSC15 CB	161	60002	TAPON PLASTICO P/TORNILLO TPN5 5mm NE	262	60576	FIELTRO ADHESIVO DZ9 85x1mm BL	288
54561	ANGULO MAMPARA 90° PARED-CRISTAL BSC16 CB	161	60003	TAPON PLASTICO P/TORNILLO TPN5 5mm MA	262	60601	TOPE 2 PUNTAS PEQUEÑO TPM1 BL	264
54562	ANGULO MAMPARA 90° CRISTAL-CRISTAL BSC17 CB	161	60004	TAPON PLASTICO P/TORNILLO TPN5 5mm BE	262	60602	TOPE 2 PUNTAS PEQUEÑO TPM1 MA	264
54563	ANGULO MAMPARA 180° CRISTAL-CRISTAL BSC18 CB	162	60101	TAPON PLASTICO P/TORNILLO TPN5 7mm BL	262	60603	TOPE 2 PUNTAS PEQUEÑO TPM1 BL (100)	264
54564	ANGULO MAMPARA 135° CRISTAL-CRISTAL BSC19 CB	162	60102	TAPON PLASTICO P/TORNILLO TPN5 7mm NE	262	60604	TOPE 2 PUNTAS PEQUEÑO TPM1 MA (100)	264
54565	PERFIL ESQUINERO CB16 30x30x1800mm AL	157	60103	TAPON PLASTICO P/TORNILLO TPN5 7mm MA	262	60611	TOPE 2 PUNTAS GRANDE TPM1 BL	264
54566	PATA REGULABLE CB10 210/370mm IN	154	60104	TAPON PLASTICO P/TORNILLO TPN5 7mm BE	262	60612	TOPE 2 PUNTAS GRANDE TPM1 MA	264
54567	PATA REGULABLE CB10 110/180mm AISI316	154	60105	TAPON PLASTICO ENVOLVENTE TPN6 BL	262	60613	TOPE 2 PUNTAS GRANDE TPM1 BL (100)	264
54568	MULETILLA ROSETA CINDICADORA CB1 AISI316	152	60106	TAPON PLASTICO ENVOLVENTE TPN6 MA	262	60614	TOPE 2 PUNTAS GRANDE TPM1 MA (100)	264
54569	ANGULO CONECTOR TUBO CB27 IN	155	60107	TAPON PLASTICO ENVOLVENTE TPN6 GR	262	60636	MANILLON ROSETA 606 NS	37
54570	BISAGRA TAQUILLA CB28 IN	153	60108	TAPON MODULO CREMALLERA TPN7 5mm BL	262	60701	PORTAESTANTE CLAVAR PE16 BL	264
54571	ANGULO MAMPARA 180° CRISTAL-CRISTAL BSC18 IN	162	60109	TAPON MODULO CREMALLERA TPN7 5mm GR	262	60702	PORTAESTANTE CLAVAR PE16 MA	264
55050	KIT CORREDERA P/CRISTAL PCR6 IN	148	60201	PORTAESTANTE ESCUADRA PE8 5mm BL	266	60801	SOPORTE LATERAL OVAL STA15 17mm BL	231
55051	KIT CORREDERA P/MADERA PCR6 IN	148	60202	PORTAESTANTE ESCUADRA PE8 5mm MA	266	60802	SOPORTE LATERAL OVAL STA15 17mm MA	231
55052	SOPORTE TUBO PARED LATERAL PCR6 IN	148	60211	CASQUILLO PLASTICO PE8 5mm BL	266	60892	CONTERA RED FLEXIBLE CNT10 20mm TR	372
55053	TUBO CORREDERA PCR6 25x3mts IN	148	60212	CASQUILLO PLASTICO PE8 5mm MA	266	60893	CONTERA RED FLEXIBLE CNT10 25mm TR	372
55055	JGO ACCESORIOS P/MADERA PCR8 80kgs	149	60301	PORTAESTANTE SAFETY PE6 5mm BL	266	60894	CONTERA RED FLEXIBLE CNT10 30mm TR	372
55056	PERFIL GUIA ALUMINIO PCR7 1,5mts AL	149	60302	PORTAESTANTE SAFETY PE6 5mm MA	266	60895	CONTERA RECT ALETAS CNT4 10x40mm NE	376
55057	PERFIL GUIA ALUMINIO PCR7 2mts AL	149	60303	PORTAESTANTE SAFETY PE6 5mm TR	266	60896	CONTERA RED CAUCHO CNT8 16-17mm NE	373
55058	PERFIL GUIA ALUMINIO PCR7 3mts AL	149	60304	PORTAESTANTE SAFETY PE6 3mm TR	266	60897	CONTERA RED CAUCHO CNT8 18-19mm NE	373
55059	PERFIL GUIA ALUMINIO PCR7 4mts AL	149	60305	PORTAESTANTE SAFETY LARGO PE7 5mm TR	266	60898	CONTERA RED CAUCHO CNT8 20-21mm NE	373
55060	TUBO CORREDERA PCR6 25x2mts IN	148	60307	PORTAESTANTE SAFETY PE6 5mm BL (100)	266	60899	CONTERA RED CAUCHO CNT8 25-26mm NE	373
55061	TUBO CORREDERA PCR6 25x4mts IN	148	60308	PORTAESTANTE SAFETY PE6 5mm MA (100)	266	60900	CONTERA RED C/ROSCA CNT6 M10x50mm NE	374
55062	ESQUINERO ALUM AN23 20x20x2,5mts BL	304	60309	PORTAESTANTE SAFETY PE6 5mm TR (100)	266	60901	CONTERA RED REFORZADA CNT1 20mm NE	374
55063	ESQUINERO ALUM AN23 20x20x2,5mts PL	304	60311	PORTAESTANTE SAFETY PE6 3mm TR (100)	266	60902	CONTERA RED REFORZADA CNT1 25mm NE	374
55064	ESQUINERO ALUM AN23 25x25x2,5mts BL	304	60401	PORTAESTANTE VITRINA PEQ PE5 BL	264	60903	CONTERA RED ALETAS CNT2 20mm NE	375
55065	ESQUINERO ALUM AN23 25x25x2,5mts PL	304	60402	PORTAESTANTE VITRINA PEQ PE5 MA	264	60904	CONTERA RED ALETAS CNT2 22mm NE	375
55066	SOPORTE TUBO PARED FRONTAL PCR6 IN	148	60403	PORTAESTANTE VITRINA PEQ PE5 BE	264	60905	CONTERA RED ALETAS CNT2 25mm NE	375
55067	KIT PUERTA CORREDERA RUSTICO PCR1 2mts NE	146	60405	PORTAESTANTE VITRINA PEQ PE5 BL (100)	264	60906	CONTERA RED ALETAS CNT2 30mm NE	375
55068	KIT PUERTA CORREDERA RUSTICO PCR1 2,5mts NE	146	60406	PORTAESTANTE VITRINA PEQ PE5 MA (100)	264	60907	CONTERA RED ALETAS CNT2 35mm NE	375
55069	KIT PUERTA CORREDERA RUSTICO PCR2 2mts NE	146	60407	PORTAESTANTE VITRINA PEQ PE5 BE (100)	264	60908	CONTERA RED ALETAS CNT2 40mm NE	375
55070	KIT PUERTA CORREDERA RUSTICO SOFT PCR2 2,5mts NE	146	60411	PORTAESTANTE VITRINA GDE PE5 BL	264	60909	CONTERA RED ALETAS CNT2 50mm NE	375
55071	KIT PUERTA CORREDERA RUSTICO PCR1 2mts NS	146	60412	PORTAESTANTE VITRINA GDE PE5 MA	264	60910	CONTERA RED ALETAS CNT2 60mm NE	375
55072	KIT PUERTA CORREDERA RUSTICO PCR1 2,5mts NS	146	60413	PORTAESTANTE VITRINA GDE PE5 BE	264	60911	CONTERA RECT ALETAS CNT4 15x30mm NE	376
55073	KIT PUERTA CORREDERA RUSTICO PCR1 2mts BL	146	60415	PORTAESTANTE VITRINA GDE PE5 BL (100)	264	60912	CONTERA RECT ALETAS CNT4 20x40mm NE	376
55074	KIT PUERTA CORREDERA RUSTICO PCR1 2,5mts BL	146	60416	PORTAESTANTE VITRINA GDE PE5 MA (100)	264	60913	CONTERA RECT ALETAS CNT4 40x60mm NE	376
55103	POLIPELO TIRA PCR9 12x2150mm BL	150	60417	PORTAESTANTE VITRINA GDE PE5 BE (100)	264	60914	CONTERA RECT ALETAS CNT4 40x80mm NE	376
55104	POLIPELO TIRA PCR9 12x2150mm NE	150	60418	PORTAESTANTE VITRINA PEQ PE5 GR	264	60915	CONTERA CUAD ALETAS CNT3 20x20mm NE	375
55105	POLIPELO TIRA PCR9 12x2150mm RB	150	60419	PORTAESTANTE VITRINA GDE PE5 GR	264	60916	CONTERA CUAD ALETAS CNT3 25x25mm NE	375
55107	JUNTA MARCO TIRA PCR10 2150mm BL	150	60420	PORTAESTANTE VITRINA PEQ PE5 GR (100)	264	60917	CONTERA CUAD ALETAS CNT3 30x30mm NE	375
55108	JUNTA MARCO TIRA PCR10 2150mm NE	150	60421	PORTAESTANTE VITRINA GDE PE5 GR (100)	264	60918	CONTERA CUAD ALETAS CNT3 35x35mm NE	375
55109	JUNTA MARCO TIRA PCR10 2150mm RB	150	60503	DESIZANTE CLAVO DZ1 15mm BL (100)	286	60919	CONTERA CUAD ALETAS CNT3 40x40mm NE	375
56510	TIRADOR ARMARIO S/B 575 IN	11	60504	DESIZANTE CLAVO DZ1 15mm MA (100)	286	60920	CONTERA CUAD ALETAS CNT3 50x50mm NE	375
56513	TIRADOR MALETERO 575 IN	11	60505	DESIZANTE CLAVO DZ1 17mm BL (100)	286	60921	CONTERA CUAD ALETAS CNT3 60x60mm NE	375
56516	MANILLON ROSETA L RECTO 565 200x19mm IN	8	60506	DESIZANTE CLAVO DZ1 17mm MA (100)	286	60922	CONTERA CUAD C/ROSCA CNT5 M10x30x30mm NE	374
57001	BL BISAGRA DOBLE ACCION BS10 BL	175	60511	DESIZANTE CLAVO DZ1 15mm BL	286	60923	CONTERA CUAD C/ROSCA CNT5 M10x40x40mm NE	374
57002	BL BISAGRA DOBLE ACCION BS10 NE	175	60512	DESIZANTE CLAVO DZ1 15mm MA	286	60924	CONTERA RED C/ROSCA CNT6 M10x40mm NE	374
57003	BL BISAGRA DOBLE ACCION BS10 OR	175	60521	DESIZANTE CLAVO DZ1 17mm BL	286	60925	RUEDA EMBUTIR GIRATORIA RUM7 40mm NE	379
57004	BL BISAGRA DOBLE ACCION BS10 PL	175	60522	DESIZANTE CLAVO DZ1 17mm MA	286	60926	RUEDA EMBUTIR FIJA RUM8 40mm NE	379
57005	BL BISAGRA DOBLE ACCION BS10 BR	175	60523	DESIZANTE ATORNILLAR GOMA DZ10 20mm TR	287	60927	RUEDA MUEBLE FIJA RUM9 15mm ZN	379
57006	BISAGRA DOBLE ACCION BS12 75mm LTD	175	60524	DESIZANTE ATORNILLAR GOMA DZ10 25mm TR	287	60928	RUEDA MUEBLE FIJA RUM9 25mm ZN	379
57007	BISAGRA DOBLE ACCION BS12 100mm LTD	175	60525	DESIZANTE ATORNILLAR SD DZ6 19mm GR	287	60929	RUEDA MUEBLE FIJA RUM9 30mm ZN	379
57008	BISAGRA DOBLE ACCION BS12 125mm LTD	175	60526	DESIZANTE ATORNILLAR SD DZ6 25mm GR	287	60930	RUEDA NIDO LATERAL RUM10 35mm ZN	380
57101	BL BISAGRA SIMPLE ACCION BS11 BL	175	60527	DESIZANTE ATORNILLAR SD DZ6 30mm GR	287	60931	RUEDA NIDO EMBUTIR RUM11 GR	380
57102	BL BISAGRA SIMPLE ACCION BS11 NE	175	60528	DESIZANTE ATORNILLAR SD DZ6 38mm GR	287	60932	RUEDA NIDO CIRCULAR RUM12 50mm GR	380
57103	BL BISAGRA SIMPLE ACCION BS11 OR	175	60531	DESIZANTE METALICO DZ3 15mm NI	286	60933	RUEDA NIDO RECTANGULAR RUM13 50mm GR	380
57104	BL BISAGRA SIMPLE ACCION BS11 PL	175	60532	DESIZANTE METALICO DZ3 18mm NI	286	60934	RUEDA EMBUTIR RUM1 22mm NE	379
57201	BL MUELLE CIERRAPUERTAS BRAZO MC2 BL	174	60533	DESIZANTE METALICO DZ3 20mm NI	286	60935	CONTERA RED ALETAS CNT2 70mm NE	375
57202	BL MUELLE CIERRAPUERTAS BRAZO MC2 NE	174	60534	DESIZANTE METALICO DZ3 23mm NI	286	60936	CONTERA RED ALETAS CNT2 80mm NE	375
57203	BL MUELLE CIERRAPUERTAS BRAZO MC2 OR	174	60535	DESIZANTE METALICO DZ3 26mm NI	286	60937	CONTERA RED ALETAS CNT2 100mm NE	375
57204	BL MUELLE CIERRAPUERTAS BRAZO MC2 PL	174	60536	DESIZANTE FIELTRO DZ2 17mm MA	286	60938	CONTERA CUAD ALETAS CNT3 22x22mm NE	375
57205	MUELLE CIERRAPUERTAS MC3 N°1 ZN	174	60537	DESIZANTE FIELTRO DZ2 20mm MA	286	60939	CONTERA CUAD ALETAS CNT3 70x70mm NE	375
57206	MUELLE CIERRAPUERTAS MC3 N°2 ZN	174	60538	DESIZANTE FIELTRO DZ2 25mm MA	286	60940	CONTERA CUAD ALETAS CNT3 80x80mm NE	375
57207	MUELLE CIERRAPUERTAS ESPIRAL MC4 NI	174	60539	DESIZANTE FIELTRO DZ2 30mm MA	286	60941	CONTERA CUAD ALETAS CNT3 100x100mm NE	375
57208	CIERRAPUERTAS S/RETENEDOR MC1-S PL	173	60540	DESIZANTE ADHESIVO SD DZ5 20mm GR	287	60942	CONTERA RECT ALETAS CNT4 20x30mm NE	376
57209	CIERRAPUERTAS S/RETENEDOR MC1-S BL	173	60541	DESIZANTE ADHESIVO SD DZ5 25mm GR	287	60943	CONTERA RECT ALETAS CNT4 25x40mm NE	376
57210	CIERRAPUERTAS S/RETENEDOR MC1-S NE	173	60542	DESIZANTE ADHESIVO SD DZ5 30mm GR	287	60944	CONTERA RECT ALETAS CNT4 30x50mm NE	376
57211	CIERRAPUERTAS S/RETENEDOR MC1-S OR	173	60543	DESIZANTE ADHESIVO SD DZ5 24x24mm GR	287	60945	CONTERA RED REFORZADA CNT1 16mm NE	374
57212	CIERRAPUERTAS S/RETENEDOR MC1-C PL	173	60544	DESIZANTE ADHESIVO SD DZ5 30x30mm GR	287	60946	CONTERA RED REFORZADA CNT1 18mm NE	374
57213	CIERRAPUERTAS S/RETENEDOR MC1-C BL	173	60545	DESIZANTE ADHESIVO SD DZ5 24x100mm GR	287	60947	CONTERA RED REFORZADA CNT1 22mm NE	374
57214	CIERRAPUERTAS S/RETENEDOR MC1-C NE	173	60546	DESIZANTE CLAVO SD DZ4 20mm GR	286	60948	CONTERA RED REFORZADA CNT1 28mm NE	374
57215	CIERRAPUERTAS S/RETENEDOR MC1-C OR	173	60547	DESIZANTE CLAVO SD DZ4 25mm GR	286	60949	CONTERA RED REFORZADA CNT1 30mm NE	374
57216	BL CIERRAPUERTAS S/RETENEDOR MC1-S PL	173	60548	DESIZANTE CLAVO SD DZ4 30mm GR	286	60950	CONTERA RED REFORZADA CNT1 32mm NE	374
57217	BL CIERRAPUERTAS S/RETENEDOR MC1-S BL	173	60549	FIELTRO ADHESIVO DZ7 16mm MA	288	60951	RUEDA COSTADO S/F RUM2 16mm NE	376

NUMÉRICO

Código	Descripción	Pág.	Código	Descripción	Pág.	Código	Descripción	Pág.
60952	RUEDA COSTADO S/F RUM2 19mm NE	376	61950	TAPON ADH TPN1 13mm NOGAL	260	62109	CANTO MELAMINA CAN2 22x5mts ROBLE	263
60953	RUEDA COSTADO C/F RUM2 19mm NE	376	61951	TAPON ADH TPN1 13mm CEREZO	260	62111	CANTO MELAMINA CAN2 22x5mts ROBLE CLARO	263
60954	RUEDA PLACA S/F RUM3 30mm NE	377	61952	TAPON ADH TPN1 13mm MAPLE	260	62112	CANTO MELAMINA CAN2 22x5mts ROBLE OSCURO	263
60955	RUEDA PLACA S/F RUM3 40mm NE	377	61953	TAPON ADH TPN1 13mm SAPELI	260	62113	CANTO ADHESIVO CAN1 19x5mts BLANCO	263
60956	RUEDA PLACA S/F RUM3 45mm NE	377	61954	TAPON ADH TPN1 13mm WENGUE	260	62114	CANTO ADHESIVO CAN1 19x5mts NEGRO	263
60957	RUEDA PLACA S/F RUM3 50mm NE	377	61955	TAPON ADH TPN1 13mm PLATA	260	62115	CANTO ADHESIVO CAN1 19x5mts GRIS	263
60958	RUEDA PLACA C/F RUM3 50mm NE	377	61956	TAPON ADH TPN1 13mm PINTABLE	260	62116	CANTO ADHESIVO CAN1 19x5mts PINO	263
60959	RUEDA ROSCA S/F RUM4 30mm NE	377	61957	TAPON ADH TPN1 13mm CROMADO	260	62117	CANTO ADHESIVO CAN1 19x5mts HAYA	263
60960	RUEDA ROSCA S/F RUM4 40mm NE	377	61958	TAPON ADH TPN1 13mm CAOBA	260	62118	CANTO ADHESIVO CAN1 19x5mts WENGUE	263
60961	RUEDA ROSCA S/F RUM4 50mm NE	377	61959	TAPON ADH TPN1 13mm CEREZO CLARO	260	62119	CANTO ADHESIVO CAN1 19x5mts NOGAL	263
60962	RUEDA ROSCA C/F RUM4 50mm NE	377	61960	TAPON ADH TPN1 13mm PINO CLARO	260	62120	PASADOR LATON PS7 200mm LS	136
60963	RUEDA PLACA S/F RUM5 50mm NE/GR	378	61961	BL TAPON ADH TPN2 17mm BLANCO (60)	261	62121	CANTO ADHESIVO CAN1 19x5mts SAPELI	263
60964	RUEDA PLACA C/F RUM5 50mm NE/GR	378	61962	BL TAPON ADH TPN2 17mm NEGRO (60)	261	62122	CANTO ADHESIVO CAN1 19x5mts CEREZO	263
60965	RUEDA ROSCA S/F RUM6 50mm NE/GR	378	61963	BL TAPON ADH TPN2 17mm GRIS (60)	261	62123	CANTO ADHESIVO CAN1 19x5mts ROBLE	263
60966	RUEDA ROSCA C/F RUM6 50mm NE/GR	378	61964	BL TAPON ADH TPN2 17mm CREMA (60)	261	62124	CANTO ADHESIVO CAN1 19x5mts ROBLE CLARO	263
60967	CONTERA RED FLEXIBLE CNT7 10mm BL	372	61965	BL TAPON ADH TPN2 17mm HAYA (60)	261	62125	PASADOR LATON PS7 250mm LS	136
60968	CONTERA RED FLEXIBLE CNT7 12mm BL	372	61966	BL TAPON ADH TPN2 17mm ROBLE (60)	261	62126	CANTO ADHESIVO CAN1 19x5mts ROBLE OSCURO	263
60969	CONTERA RED FLEXIBLE CNT7 14mm BL	372	61967	BL TAPON ADH TPN2 17mm PINO (60)	261	62130	PASADOR LATON PS7 300mm LS	136
60970	CONTERA RED FLEXIBLE CNT7 16mm BL	372	61968	BL TAPON ADH TPN2 17mm NOGAL (60)	261	62140	PASADOR LATON PS7 400mm LS	136
60971	CONTERA RED FLEXIBLE CNT7 18mm BL	372	61969	BL TAPON ADH TPN2 17mm MAPLE (60)	261	62220	PASADOR LATON PS7 200mm NS	136
60972	CONTERA RED FLEXIBLE CNT7 20mm BL	372	61970	BL TAPON ADH TPN2 17mm SAPELI (60)	261	62225	PASADOR LATON PS7 250mm NS	136
60973	CONTERA RED FLEXIBLE CNT7 22mm BL	372	61971	BL TAPON ADH TPN2 17mm WENGUE (60)	261	62230	PASADOR LATON PS7 300mm NS	136
60974	CONTERA RED FLEXIBLE CNT7 25mm BL	372	61972	TAPON ADH TPN1 13mm ROBLE CLARO	260	62240	PASADOR LATON PS7 400mm NS	136
60975	CONTERA RED FLEXIBLE CNT7 28mm BL	372	61973	TAPON ADH TPN1 13mm ROBLE OSCURO	260	62320	PASADOR LATON PS7 200mm CU*	136
60976	CONTERA RED FLEXIBLE CNT7 30mm BL	372	61974	TAPON ADH TPN1 13mm CENIZA	260	62325	PASADOR LATON PS7 250mm CU*	136
60977	CONTERA RED FLEXIBLE CNT7 32mm BL	372	61975	TAPON ADH TPN1 13mm GRIS BEIGE	260	62330	PASADOR LATON PS7 300mm CU*	136
60978	CONTERA RED FLEXIBLE CNT7 35mm BL	372	61981	TAPON ADH TPN2 17mm BLANCO	261	62340	PASADOR LATON PS7 400mm CU*	136
60979	CONTERA RED FLEXIBLE CNT7 40mm BL	372	61982	TAPON ADH TPN2 17mm NEGRO	261	63105	PASADOR ALUMINIO D8 PS5 50mm OR	76
60980	CONTERA RED FLEXIBLE CNT7 42mm BL	372	61983	TAPON ADH TPN2 17mm GRIS	261	63107	PASADOR ALUMINIO D8 PS5 75mm OR	76
60981	CONTERA RED FLEXIBLE CNT7 45mm BL	372	61984	TAPON ADH TPN2 17mm CREMA	261	63110	PASADOR ALUMINIO D8 PS5 100mm OR	76
60982	CONTERA RED FLEXIBLE CNT7 50mm BL	372	61985	TAPON ADH TPN2 17mm HAYA	261	63115	PASADOR ALUMINIO D8 PS5 150mm OR	76
60983	CONTERA RED FLEXIBLE CNT7 10mm NE	372	61986	TAPON ADH TPN2 17mm ROBLE	261	63120	PASADOR ALUMINIO D8 PS5 200mm OR	76
60984	CONTERA RED FLEXIBLE CNT7 12mm NE	372	61987	TAPON ADH TPN2 17mm PINO	261	63125	PASADOR ALUMINIO D8 PS5 250mm OR	76
60985	CONTERA RED FLEXIBLE CNT7 14mm NE	372	61988	TAPON ADH TPN2 17mm NOGAL	261	63130	PASADOR ALUMINIO D8 PS5 300mm OR	76
60986	CONTERA RED FLEXIBLE CNT7 16mm NE	372	61989	TAPON ADH TPN2 17mm MAPLE	261	63140	PASADOR ALUMINIO D8 PS5 400mm OR	76
60987	CONTERA RED FLEXIBLE CNT7 18mm NE	372	61990	TAPON ADH TPN2 17mm SAPELI	261	63141	PASADOR ALUMINIO D12 PS5 100mm OR	77
60988	CONTERA RED FLEXIBLE CNT7 20mm NE	372	61991	TAPON ADH TPN2 17mm WENGUE	261	63142	PASADOR ALUMINIO D12 PS5 150mm OR	77
60989	CONTERA RED FLEXIBLE CNT7 22mm NE	372	61992	TAPON ADH TPN2 17mm CEREZO	261	63143	PASADOR ALUMINIO D12 PS5 200mm OR	77
60990	CONTERA RED FLEXIBLE CNT7 25mm NE	372	61995	TAPON ADH P/BISAGRA TPN4 BLANCO	262	63144	PASADOR ALUMINIO D12 PS5 250mm OR	77
60991	CONTERA RED FLEXIBLE CNT7 28mm NE	372	61996	TAPON ADH P/BISAGRA TPN4 GRIS	262	63145	PASADOR ALUMINIO D12 PS5 300mm OR	77
60992	CONTERA RED FLEXIBLE CNT7 30mm NE	372	61997	TAPON ADH P/BISAGRA TPN4 ROBLE	262	63146	PASADOR ALUMINIO D12 PS5 400mm OR	77
60993	CONTERA RED FLEXIBLE CNT7 32mm NE	372	61998	TAPON ADH P/BISAGRA TPN4 HAYA	262	63205	PASADOR ALUMINIO D8 PS5 50mm BL	76
60994	CONTERA RED FLEXIBLE CNT7 35mm NE	372	61999	TAPON ADH TPN3 25mm BLANCO	261	63207	PASADOR ALUMINIO D8 PS5 75mm BL	76
60995	CONTERA RED FLEXIBLE CNT7 40mm NE	372	62000	TAPON ADH TPN3 25mm NEGRO	261	63210	PASADOR ALUMINIO D8 PS5 100mm BL	76
60996	CONTERA RED FLEXIBLE CNT7 42mm NE	372	62001	TAPON ADH TPN3 25mm GRIS	261	63215	PASADOR ALUMINIO D8 PS5 150mm BL	76
60997	CONTERA RED FLEXIBLE CNT7 45mm NE	372	62002	TAPON ADH TPN3 25mm HAYA	261	63220	PASADOR ALUMINIO D8 PS5 200mm BL	76
60998	CONTERA RED FLEXIBLE CNT7 50mm NE	372	62003	TAPON ADH TPN3 25mm ROBLE	261	63225	PASADOR ALUMINIO D8 PS5 250mm BL	76
60999	CONTERA P/MULETAS CNT9 18-19mm NE	374	62004	TAPON ADH TPN3 25mm CEREZO	261	63230	PASADOR ALUMINIO D8 PS5 300mm BL	76
61000	ANGULO TRASERA AN22 19x19mm NI	278	62005	TAPON ADH TPN3 25mm WENGUE	261	63240	PASADOR ALUMINIO D8 PS5 400mm BL	76
61001	ANGULO C/TAPA PEQ AN20 18x20mm BL	278	62006	TAPON ADH TPN2 17mm TEXTIL OSCURO	261	63241	PASADOR ALUMINIO D12 PS5 100mm BL	77
61002	ANGULO C/TAPA GDE AN20 42x20mm BL	278	62007	TAPON ADH TPN2 17mm TEXTIL CLARO	261	63242	PASADOR ALUMINIO D12 PS5 150mm BL	77
61003	ANGULO TRASERA C/TORN AN21 14x12mm NE	278	62008	TAPON ADH TPN2 17mm TEXTIL BEIGE	261	63243	PASADOR ALUMINIO D12 PS5 200mm BL	77
61011	ANGULO C/TAPA PEQ AN20 18x20mm BE	278	62009	TAPON ADH TPN2 17mm GRIS MARENGO	261	63244	PASADOR ALUMINIO D12 PS5 250mm BL	77
61012	ANGULO C/TAPA GDE AN20 42x20mm BE	278	62010	TAPON ADH TPN2 17mm ANTRACITA	261	63245	PASADOR ALUMINIO D12 PS5 300mm BL	77
61021	ANGULO C/TAPA PEQ AN20 18x20mm MA	278	62011	BL TAPON ADH TPN2 17mm TEXTIL OSCURO (60)	261	63246	PASADOR ALUMINIO D12 PS5 400mm BL	77
61022	ANGULO C/TAPA GDE AN20 42x20mm MA	278	62012	BL TAPON ADH TPN2 17mm TEXTIL CLARO (60)	261	63247	PASADOR ALUMINIO D8 PS5 50mm NE	76
61901	BL TAPON ADH TPN1 13mm BLANCO (100)	260	62013	BL TAPON ADH TPN2 17mm TEXTIL BEIGE (60)	261	63248	PASADOR ALUMINIO D8 PS5 75mm NE	76
61902	BL TAPON ADH TPN1 13mm BL PORO (100)	260	62014	BL TAPON ADH TPN2 17mm GRIS MARENGO (60)	261	63249	PASADOR ALUMINIO D8 PS5 100mm NE	76
61903	BL TAPON ADH TPN1 13mm NEGRO (100)	260	62015	BL TAPON ADH TPN2 17mm ANTRACITA (60)	261	63250	PASADOR ALUMINIO D8 PS5 150mm NE	76
61904	BL TAPON ADH TPN1 13mm NE PORO (100)	260	62016	BL TAPON ADH TPN2 17mm TEXTIL OSCURO (20)	261	63251	PASADOR ALUMINIO D8 PS5 200mm NE	76
61905	BL TAPON ADH TPN1 13mm GRIS (100)	260	62017	BL TAPON ADH TPN2 17mm TEXTIL CLARO (20)	261	63252	PASADOR ALUMINIO D8 PS5 250mm NE	76
61906	BL TAPON ADH TPN1 13mm CREMA (100)	260	62018	BL TAPON ADH TPN2 17mm TEXTIL BEIGE (20)	261	63253	PASADOR ALUMINIO D8 PS5 300mm NE	76
61907	BL TAPON ADH TPN1 13mm HAYA (100)	260	62019	BL TAPON ADH TPN2 17mm GRIS MARENGO (20)	261	63254	PASADOR ALUMINIO D8 PS5 400mm NE	76
61908	BL TAPON ADH TPN1 13mm ROBLE (100)	260	62020	BL TAPON ADH TPN2 17mm ANTRACITA (20)	261	63255	PASADOR ALUMINIO D12 PS5 100mm NE	77
61909	BL TAPON ADH TPN1 13mm PINO (100)	260	62021	TAPON ADH TPN1 13mm ALUMINIO	260	63256	PASADOR ALUMINIO D12 PS5 150mm NE	77
61910	BL TAPON ADH TPN1 13mm NOGAL (100)	260	62022	TAPON ADH TPN1 13mm ABEDUL	260	63257	PASADOR ALUMINIO D12 PS5 200mm NE	77
61911	BL TAPON ADH TPN1 13mm CEREZO (100)	260	62023	TAPON ADH TPN1 13mm NUEZ	260	63258	PASADOR ALUMINIO D12 PS5 250mm NE	77
61912	BL TAPON ADH TPN1 13mm MAPLE (100)	260	62024	TAPON ADH TPN1 13mm OLMO CLARO	260	63259	PASADOR ALUMINIO D12 PS5 300mm NE	77
61913	BL TAPON ADH TPN1 13mm SAPELI (100)	260	62025	TAPON ADH TPN1 13mm OLMO OSCURO	260	63260	PASADOR ALUMINIO D12 PS5 400mm NE	77
61914	BL TAPON ADH TPN1 13mm WENGUE (100)	260	62026	TAPON ADH TPN1 13mm ROBLE BLANCO	260	63305	PASADOR ALUMINIO D8 PS5 50mm PL	76
61915	BL TAPON ADH TPN1 13mm PLATA (100)	260	62027	TAPON ADH TPN1 13mm SICOMORO	260	63307	PASADOR ALUMINIO D8 PS5 75mm PL	76
61916	BL TAPON ADH TPN1 13mm GRIS MARENGO (100)	260	62028	TAPON ADH TPN1 13mm WENGUE CENIZA	260	63310	PASADOR ALUMINIO D8 PS5 100mm PL	76
61917	BL TAPON ADH TPN1 13mm ANTRACITA (100)	260	62029	TAPON ADH TPN1 13mm FRESNO	260	63315	PASADOR ALUMINIO D8 PS5 150mm PL	76
61918	BL TAPON ADH TPN1 13mm GRIS MARENGO (20)	260	62030	BL TAPON ADH TPN1 13mm ALUMINIO (20)	260	63320	PASADOR ALUMINIO D8 PS5 200mm PL	76
61919	BL TAPON ADH TPN1 13mm ANTRACITA (20)	260	62031	BL TAPON ADH TPN1 13mm ABEDUL (20)	260	63325	PASADOR ALUMINIO D8 PS5 250mm PL	76
61921	LAGRIMA ADHESIVA LGM1 7x1,5mm TR	258	62032	BL TAPON ADH TPN1 13mm NUEZ (20)	260	63330	PASADOR ALUMINIO D8 PS5 300mm PL	76
61922	LAGRIMA ADHESIVA LGM1 10x3mm TR	258	62033	BL TAPON ADH TPN1 13mm OLMO CLARO (20)	260	63340	PASADOR ALUMINIO D8 PS5 400mm PL	76
61923	LAGRIMA ADHESIVA LGM2 13x4mm TR	258	62034	BL TAPON ADH TPN1 13mm OLMO OSCURO (20)	260	63341	PASADOR ALUMINIO D12 PS5 100mm PL	77
61924	LAGRIMA EMBUTIR BIMATERIAL LGM8 8,8x2,5mm TR	259	62035	BL TAPON ADH TPN1 13mm ROBLE BLANCO (20)	260	63342	PASADOR ALUMINIO D12 PS5 150mm PL	77
61925	LAGRIMA ADHESIVA LGM1 8x2,2mm TR	258	62036	BL TAPON ADH TPN1 13mm SICOMORO (20)	260	63343	PASADOR ALUMINIO D12 PS5 200mm PL	77
61926	LAGRIMA ADHESIVA LGM1 10x1,5mm TR	258	62037	BL TAPON ADH TPN1 13mm WENGUE CENIZA (20)	260	63344	PASADOR ALUMINIO D12 PS5 250mm PL	77
61927	LAGRIMA ADHESIVA LGM3 16x7,9mm TR	258	62038	BL TAPON ADH TPN1 13mm FRESNO (20)	260	63345	PASADOR ALUMINIO D12 PS5 300mm PL	77
61928	LAGRIMA ADHESIVA LGM4 20x6,2mm TR	258	62039	BL TAPON ADH TPN1 13mm ALUMINIO (100)	260	63346	PASADOR ALUMINIO D12 PS5 400mm PL	77
61929	LAGRIMA ADHESIVA LGM5 10x10x2,5mm TR	259	62040	BL TAPON ADH TPN1 13mm ABEDUL (100)	260	64004	DEDAL EMBUTIR CUADRADO DDL2 NE	138
61930	LAGRIMA ADHESIVA LGM6 12,5x12,5x5,8 TR	259	62041	BL TAPON ADH TPN1 13mm NUEZ (100)	260	64005	DEDAL EMBUTIR CUADRADO DDL2 CU	138
61932	LAGRIMA ADHESIVA LGM7 20,5x20,5x7,8 TR	259	62042	BL TAPON ADH TPN1 13mm OLMO CLARO (100)	260	64006	DEDAL EMBUTIR CUADRADO DDL2 LP	138
61936	TAPON ADH TPN1 13mm GRIS MARENGO	260	62043	BL TAPON ADH TPN1 13mm OLMO OSCURO (100)	260	64007	DEDAL EMBUTIR CUADRADO DDL2 NS	138
61937	TAPON ADH TPN1 13mm ANTRACITA	260	62044	BL TAPON ADH TPN1 13mm ROBLE BLANCA (100)	260	64008	DEDAL EMBUTIR DDL1 8mm LT	138
61938	TAPON ADH TPN1 13mm TEXTIL OSCURO	260	62045	BL TAPON ADH TPN1 13mm SICOMORO (100)	260	64010	DEDAL EMBUTIR DDL1 10mm LT	138
61939	TAPON ADH TPN1 13mm TEXTIL CLARO	260	62046	BL TAPON ADH TPN1 13mm WENGUE CENIZA (100)	260	64012	DEDAL EMBUTIR DDL1 12mm LT	138
61940	TAPON ADH TPN1 13mm TEXTIL BEIGE	260	62047	BL TAPON ADH TPN1 13mm FRESNO (100)	260	64014	DEDAL EMBUTIR DDL1 14mm LT	138
61941	TAPON ADH TPN1 13mm BLANCO	260	62100	CANTO MELAMINA CAN2 22x5mts BLANCO	263	64020	DEDAL EMBUTIR DDL1 20mm LT	138
61942	TAPON ADH TPN1 13mm BLANCO PORO	260	62101	CANTO MELAMINA CAN2 22x5mts NEGRO	263	64022	DEDAL EMBUTIR DDL1 22mm LT	138
61943	TAPON ADH TPN1 13mm NEGRO	260	62102	CANTO MELAMINA CAN2 22x5mts GRIS	263	64108	DEDAL EMBUTIR DDL1 8mm NI	138
61944	TAPON ADH TPN1 13mm NEGRO PORO	260	62103	CANTO MELAMINA CAN2 22x5mts PINO	263	64110	DEDAL EMBUTIR DDL1 10mm NI	138
61945	TAPON ADH TPN1 13mm GRIS	260	62104	CANTO MELAMINA CAN2 22x5mts HAYA	263	64112	DEDAL EMBUTIR DDL1 12mm NI	138
61946	TAPON ADH TPN1 13mm CREMA	260	62105	CANTO MELAMINA CAN2 22x5mts WENGUE	263	64114	DEDAL EMBUTIR DDL1 14mm NI	138
61947	TAPON ADH TPN1 13mm HAYA	260	62106	CANTO MELAMINA CAN2 22x5mts NOGAL	263	64120	DEDAL EMBUTIR DDL1 20mm NI	138
61948	TAPON ADH TPN1 13mm ROBLE	260	62107	CANTO MELAMINA CAN2 22x5mts SAPELI	263	64122	DEDAL EMBUTIR DDL1 22mm NI	138
61949	TAPON ADH TPN1 13mm PINO	260	62108	CANTO MELAMINA CAN2 22x5mts CEREZO	263	65001	JGO BISAGRA PIVOTANTE BS13 80x10mm LTD	182

NUMÉRICO

Código	Descripción	Pág.	Código	Descripción	Pág.	Código	Descripción	Pág.
65002	JGO BISAGRA PIVOTANTE BS14 60x10mm LTD	182	67342	BISAGRA 5005 2"1/4 BS27 56x31mm LTD	186	68088	PERNIO RODAMIENTO AXIAL 694 20x120mm PU	180
65003	JGO BISAGRA PIVOTANTE C/R BS9 100kgs IN	182	67343	BISAGRA 5005 2"1/2 BS27 63x32mm LTD	186	68089	PERNIO RODAMIENTO AXIAL 694 22x120mm PU	180
65004	JGO BISAGRA PIVOTANTE C/C BS9 100kgs IN	182	67344	BISAGRA 5005 2"3/4 BS27 69x36mm LTD	186	68090	PERNIO PERFIL GOTTA 695 10x60mm PU	180
65010	BISAGRA OCULTA BS1 10mm LS	183	67345	BISAGRA 5005 3" BS27 75x42mm LTD	186	68091	PERNIO PERFIL GOTTA 695 14x80mm PU	180
65012	BISAGRA OCULTA BS1 12mm LS	183	67346	BISAGRA 5005 3"1/2 BS27 87x49mm LTD	186	68092	PERNIO PERFIL GOTTA 695 16x100mm PU	180
65014	BISAGRA OCULTA BS1 14mm LS	183	67347	BISAGRA 5005 4" BS27 100x53mm LTD	186	68093	PERNIO PERFIL GOTTA 695 16x120mm PU	180
66610	TIRADOR ARMARIO S/B 666 LP	31	67350	BISAGRA OCULTA BS2 65x13mm LTD	183	68094	PERNIO PALA 696 10x60mm PU	181
66611	PLACA LIMPIEZA 666 LP	30	67351	BISAGRA OCULTA BS2 65x13mm NI	183	68095	PERNIO PALA 696 14x80mm PU	181
66613	TIRADOR MALETERO 666 LP	31	67352	BISAGRA OCULTA BS2 65x13mm BR	183	68096	PERNIO PALA 696 16x100mm PU	181
66616	MANILLON PLACA 666 LP	30	67353	BISAGRA OCULTA BS3 89x25mm IN	183	68097	PERNIO PALA 696 18x110mm PU	181
67252	BISAGRA 5005 3/4 BS27 19x15mm PU	186	67354	BISAGRA OCULTA BS4 60x12,7mm IN	183	68098	BISAGRA LIBRO 697 80x50mm PU	181
67253	BISAGRA 5005 1" BS27 25x20mm PU	186	67355	BISAGRA OCULTA BS4 70x15,8mm IN	183	68099	BISAGRA LIBRO 697 100x64mm PU	181
67254	BISAGRA 5005 1"1/4 BS27 31x22mm PU	186	67356	BISAGRA OCULTA BS4 95x19,5mm IN	183	68100	POLEA GUIA NYLON 698 30x30mm BL	149
67255	BISAGRA 5005 1"1/2 BS27 37x26mm PU	186	67358	BISAGRA MUEBLE BS5 26mm NI	184	68101	POLEA GUIA NYLON 698 35x35mm BL	149
67256	BISAGRA 5005 1"3/4 BS27 43x28mm PU	186	67359	SUPLEMENTO BISAGRA BS5 2mm NI*	184	68102	POLEA GUIA NYLON 698 40x40mm BL	149
67257	BISAGRA 5005 2" BS27 50x30mm PU	186	67360	SUPLEMENTO BISAGRA BS5 4mm NI*	184	68103	CAJA CERRADURA PICOLORO CRR3 40mm ZN	172
67258	BISAGRA 5005 2"1/4 BS27 56x31mm PU	186	68000	JGO MANILLA 6800 ALUM BL	54	68104	CAJA CERRADURA PICOLORO CRR3 50mm ZN	172
67259	BISAGRA 5005 2"1/2 BS27 63x32mm PU	186	68001	JGO MANILLA 6800 ALUM NE	54	68105	PASADOR 700 BASIC NI	137
67260	BISAGRA 5005 2"3/4 BS27 69x36mm PU	186	68002	JGO MANILLA 6800 ALUM PL	54	68106	PASADOR 700 STRONG NI	137
67261	BISAGRA 5005 3" BS27 75x42mm PU	186	68003	CIERRE PRESION DCHA 6801 ALUM BL	56	68107	PASADOR 700 DOUBLE NI	137
67262	BISAGRA 5005 3"1/2 BS27 87x49mm PU	186	68004	CIERRE PRESION IZDA 6801 ALUM BL	56	68108	REMATÉ PASADOR 700 M8 NI	137
67263	BISAGRA 5005 4" BS27 100x53mm PU	186	68005	CIERRE PRESION DCHA 6801 ALUM NE	56	68110	OVALILLO OV2 10x7x1,5mm LT	179
67264	BISAGRA 5005 3/4 BS27 19x15mm ZN	186	68006	CIERRE PRESION IZDA 6801 ALUM NE	56	68111	OVALILLO OV2 12x8x1,5mm LT	179
67265	BISAGRA 5005 1" BS27 25x20mm ZN	186	68007	CIERRE PRESION DCHA 6801 ALUM PL	56	68112	OVALILLO OV2 14x9x2mm LT	179
67266	BISAGRA 5005 1"1/4 BS27 31x22mm ZN	186	68008	CIERRE PRESION IZDA 6801 ALUM PL	56	68113	OVALILLO OV2 16x11x2mm LT	179
67267	BISAGRA 5005 1"1/2 BS27 37x26mm ZN	186	68009	JGO MANILLA 6802 ALUM BL	54	68114	OVALILLO OV2 18x11x2mm LT	179
67268	BISAGRA 5005 1"3/4 BS27 43x28mm ZN	186	68010	JGO MANILLA 6802 ALUM NE	54	68115	OVALILLO OV2 20x12x2mm LT	179
67269	BISAGRA 5005 2" BS27 50x30mm ZN	186	68011	JGO MANILLA 6802 ALUM PL	54	68116	OVALILLO OV2 22x14x2,5mm LT	179
67270	BISAGRA 5005 2"1/4 BS27 56x31mm ZN	186	68012	JGO POMO RECUPERABLE 6807 ALUM BL	60	68117	OVALILLO OV2 25x15x2,5mm LT	179
67271	BISAGRA 5005 2"1/2 BS27 63x32mm ZN	186	68013	JGO POMO RECUPERABLE 6807 ALUM NE	60	68118	CERRADURA PICOLORO CRR3 60mm ZN	172
67272	BISAGRA 5005 2"3/4 BS27 69x36mm ZN	186	68014	JGO POMO RECUPERABLE 6807 ALUM PL	60	68119	CERRADURA PICOLORO CRR3 40mm ZN	172
67273	BISAGRA 5005 3" BS27 75x42mm ZN	186	68015	ASA PLACA REDONDA 6803 ALUM BL	61	68120	CERRADURA PICOLORO CRR3 30mm ZN	172
67274	BISAGRA 5005 3"1/2 BS27 87x49mm ZN	186	68016	ASA PLACA REDONDA 6803 ALUM NE	61	68121	CERRADERO P/CERRADURA PICOLORO CRR3 ZN	172
67275	BISAGRA 5005 4" BS27 100x53mm ZN	186	68017	ASA PLACA REDONDA 6803 ALUM PL	61	68122	JGO MANILLA 702 ALUM BL	55
67276	BISAGRA RAMAL 2" BS28 22x50mm PU	187	68018	ASA PLACA RECTA 6804 ALUM BL	60	68123	JGO MANILLA 702 ALUM NE	55
67277	BISAGRA RAMAL 2"1/2 BS28 22x63 PU	187	68019	ASA PLACA RECTA 6804 ALUM NE	60	68124	JGO MANILLA 702 ALUM PL	55
67278	BISAGRA RAMAL 3" BS28 25x75mm PU	187	68020	ASA PLACA RECTA 6804 ALUM PL	60	68125	GOLPETE 6810 ALUM BL	75
67279	BISAGRA RAMAL 4" BS28 25x100mm PU	187	68021	ESCUUDO BOCALLAVE 6811 BL	77	68126	GOLPETE 6810 ALUM NE	75
67280	BISAGRA RAMAL 5" BS28 27x125mm PU	187	68022	ESCUUDO BOCALLAVE 6811 NE	77	68127	GOLPETE 6810 ALUM PL	75
67281	BISAGRA RAMAL 6" BS28 27x150mm PU	187	68024	ASA CORREDERA 6809 ALUM BL	61	68128	CONTRACRIERRE ZAMAK 6819-01 ZN	65
67282	BISAGRA RAMAL 7" BS28 22x50mm ZN	187	68025	ASA CORREDERA 6809 ALUM NE	61	68129	CONTRACRIERRE ZAMAK 6819-02 ZN	65
67283	BISAGRA RAMAL 2"1/2 BS28 22x63 ZN	187	68026	ASA CORREDERA 6809 ALUM PL	61	68130	CONTRACRIERRE ZAMAK 6819-05 ZN	65
67284	BISAGRA RAMAL 3" BS28 25x75mm ZN	187	68027	GOLPETE EU 6808 ALUM BL	75	68131	CONTRACRIERRE ZAMAK 6819-12 BC	65
67285	BISAGRA RAMAL 4" BS28 25x100mm ZN	187	68028	GOLPETE EU 6808 ALUM NE	75	68132	PASADOR RULETA 6825 ALUM BL	77
67286	BISAGRA RAMAL 5" BS28 27x125mm ZN	187	68029	GOLPETE EU 6808 ALUM PL	75	68133	PASADOR RULETA 6825 ALUM NE	77
67287	BISAGRA RAMAL 6" BS28 27x150mm ZN	187	68030	MANILLA MULTIPUNTO 6806 ALUM BL	68	68134	PASADOR RULETA 6825 ALUM PL	77
67288	BISAGRA 814 3/4 BS29 22x64mm PU	187	68031	MANILLA MULTIPUNTO 6806 ALUM NE	68	68135	CIERRE CORREDERA LLI/ 6826 ALUM BL	64
67289	BISAGRA 814 1" BS29 25x76mm PU	187	68032	CERRADERO LENGÜETA 6818-01 ZN	65	68136	CIERRE CORREDERA LLI/ 6826 ALUM NE	64
67290	BISAGRA 814 1"1/4 BS29 31x84mm PU	187	68033	BISAGRA EU DCHA 6812 ALUM BL	67	68137	PROLONGADOR CIERRE CORREDERA 6826 NI	64
67291	BISAGRA 814 1"1/2 BS29 37x90mm PU	187	68034	BISAGRA EU IZDA 6812 ALUM BL	67	68138	JGO MANILLA 6827 ALUM BL	55
67292	BISAGRA 814 1"3/4 BS29 43x102mm PU	187	68035	BISAGRA EU DCHA 6812 ALUM NE	67	68139	JGO MANILLA 6827 ALUM NE	55
67293	BISAGRA 814 2" BS29 50x112mm PU	187	68036	BISAGRA EU IZDA 6812 ALUM NE	67	68140	JGO MANILLA 6827 ALUM PL	55
67294	BISAGRA 814 2"1/4 BS29 56x130mm PU	187	68037	BISAGRA EU DCHA 6812 ALUM PL	67	68141	CREMONA 1 PATILLA 6828 ALUM BL	70
67295	BISAGRA 814 2"1/2 BS29 63x150mm PU	187	68038	BISAGRA EU IZDA 6812 ALUM PL	67	68142	CREMONA 1 PATILLA 6828 ALUM NE	70
67296	BISAGRA 814 3" BS29 75x175mm PU	187	68039	BISAGRA 40/20 DCHA 6813 ALUM BL	67	68143	CREMONA 2 PATILLAS 6829 ALUM BL	70
67297	BISAGRA 814 3/4 BS29 22x64mm ZN	187	68040	BISAGRA 40/20 IZDA 6813 ALUM BL	67	68144	CREMONA 2 PATILLAS 6829 ALUM NE	70
67298	BISAGRA 814 1" BS29 25x76mm ZN	187	68041	BISAGRA 40/20 DCHA 6813 ALUM NE	67	68145	CREMONA 2 PATILLAS LLI 6830 ALUM BL	70
67299	BISAGRA 814 1"1/4 BS29 31x84mm ZN	187	68042	BISAGRA 40/20 IZDA 6813 ALUM NE	67	68146	CREMONA 2 PATILLAS LLI 6830 ALUM NE	70
67300	BISAGRA 814 1"1/2 BS29 37x90mm ZN	187	68043	BISAGRA 40/20 DCHA 6813 ALUM PL	67	68147	CREMONA PATILLA U 6831 ALUM BL	70
67301	BISAGRA 814 1"3/4 BS29 43x102mm ZN	187	68044	BISAGRA 40/20 IZDA 6813 ALUM PL	67	68148	CREMONA PATILLA U 6831 ALUM NE	70
67302	BISAGRA 814 2" BS29 50x112mm ZN	187	68045	CIERRE PRESION DCHA 6805 ALUM BL	57	68149	CREMONA C/MUELLE 6832 ALUM BL	71
67303	BISAGRA 814 2"1/4 BS29 56x130mm ZN	187	68046	CIERRE PRESION IZDA 6805 ALUM BL	57	68150	CREMONA C/MUELLE 6832 ALUM NE	71
67304	BISAGRA 814 2"1/2 BS29 63x150mm ZN	187	68047	CIERRE PRESION DCHA 6805 ALUM NE	57	68151	CREMONA SEGURIDAD 6833 ALUM BL	71
67305	BISAGRA 814 3" BS29 75x175mm ZN	187	68048	CIERRE PRESION IZDA 6805 ALUM NE	57	68152	CREMONA SEGURIDAD 6833 ALUM NE	71
67306	BISAGRA 816 1" BS30 22x50mm PU	188	68049	CIERRE PRESION DCHA 6805 ALUM PL	57	68153	MANETA P/CREMONA 6833 ALUM BL	71
67307	BISAGRA 816 1"1/4 BS30 31x57mm PU	188	68050	CIERRE PRESION IZDA 6805 ALUM PL	57	68154	MANETA P/CREMONA 6833 ALUM NE	71
67308	BISAGRA 816 1"1/2 BS30 37x70mm PU	188	68051	CREMONA 2 PATILLAS 6814 ALUM BL	69	68155	CREMONA SEGURIDAD 6834 ALUM BL	72
67309	BISAGRA 816 1"3/4 BS30 43x78mm PU	188	68052	CREMONA 2 PATILLAS 6814 ALUM NE	69	68156	CREMONA SEGURIDAD 6834 ALUM NE	72
67310	BISAGRA 816 2" BS30 50x95mm PU	188	68053	CREMONA 2 PATILLAS 6815 ALUM BL	69	68157	MANETA P/CREMONA 6834 ALUM BL	72
67311	BISAGRA 816 2"1/4 BS30 56x103mm PU	188	68054	CREMONA 2 PATILLAS 6815 ALUM NE	69	68158	MANETA P/CREMONA 6834 ALUM NE	72
67312	BISAGRA 816 2"1/2 BS30 63x120mm PU	188	68055	CREMONA 2 PATILLAS 6816 ALUM BL	69	68159	CREMONA AC-20 OLD 6835 ALUM BL	73
67313	BISAGRA 816 1" BS30 22x50mm ZN	188	68056	CREMONA 2 PATILLAS 6816 ALUM NE	69	68160	CREMONA AC-20 OLD 6835 ALUM NE	73
67314	BISAGRA 816 1"1/4 BS30 31x57mm ZN	188	68057	CREMONA 2 PATILLAS 6817 ALUM BL	69	68161	CREMONA AC-20 NEW 6835 ALUM BL	73
67315	BISAGRA 816 1"1/2 BS30 37x70mm ZN	188	68058	CREMONA 2 PATILLAS 6817 ALUM NE	69	68162	CREMONA AC-20 NEW 6835 ALUM NE	73
67316	BISAGRA 816 1"3/4 BS30 43x78mm ZN	188	68059	CERRADERO LENGÜETA 6818-22 ZN	65	68163	CIERRE CORREDERA 6836 PLASTICO BL	64
67317	BISAGRA 816 2" BS30 50x95mm ZN	188	68060	CERRADERO LENGÜETA 6818-25 ZN	65	68164	CIERRE CORREDERA 6836 PLASTICO NE	64
67318	BISAGRA 816 2"1/4 BS30 56x103mm ZN	188	68061	CIERRE CORREDERA 6820 ALUM BL	62	68165	CONTRACRIERRE ZAMAK 6819-00 NE	65
67319	BISAGRA 816 2"1/2 BS30 63x120mm ZN	188	68062	CIERRE CORREDERA 6820 ALUM NE	62	68166	CONTRACRIERRE ZAMAK 6819-00 ZN	65
67320	BISAGRA 840 3" BS31 75x49mm PU	188	68063	CIERRE CORREDERA 6821 ALUM BL	63	68167	CONTRACRIERRE ZAMAK 6819-06 ZN	65
67321	BISAGRA 840 3"1/2 BS31 87x55mm PU	188	68064	CIERRE CORREDERA 6821 ALUM NE	63	68168	CONTRACRIERRE ZAMAK 6819-08 ZN	65
67322	BISAGRA 840 4" BS31 100x70mm PU	188	68065	CIERRE CORREDERA 6822 ALUM BL	63	68169	PASADOR EUROPEO 6837 142x20mm BL	73
67323	BISAGRA 840 4"1/2 BS31 112x75mm PU	188	68066	CIERRE CORREDERA 6822 ALUM NE	63	68170	PASADOR EUROPEO 6837 142x20mm NE	73
67324	BISAGRA 840 5" BS31 125x85mm PU	188	68067	CIERRE CORREDERA 6823 ALUM BL	63	68171	PASADOR EUROPEO 6837 217x20mm BL	73
67325	BISAGRA 840 5" BS31 125x85mm ZN	188	68068	CIERRE CORREDERA 6823 ALUM NE	63	68172	PASADOR EUROPEO 6837 217x20mm NE	73
67326	BISAGRA 840 3"1/2 BS31 87x55mm ZN	188	68069	JGO MANILLA C/B 6824 ALUM BL	58	68173	BISAGRA COMPAS EUROPEO 6838 ALUM BL	75
67327	BISAGRA 840 4" BS31 100x70mm ZN	188	68070	JGO MANILLA C/B 6824 ALUM NE	58	68174	BISAGRA COMPAS EUROPEO 6838 ALUM NE	75

NUMÉRICO

Código	Descripción	Pág.	Código	Descripción	Pág.	Código	Descripción	Pág.
68189	JGO MANILLA 6846 ALUM BL	55	68289	CERRADERO EUROPEO 6851 225x22mm NE	74	72161	SOPORTE CERRADO STA3 16mm NI	230
68190	JGO MANILLA 6846 ALUM NE	55	68290	KIT ABATIBLE 1 HOJA 40/20 6852 NE	74	72191	SOPORTE CERRADO STA3 19mm NI	230
68191	JGO MANILLA 6846 ALUM PL	55	68291	KIT ABATIBLE 2° HOJA 40/20 6852 NE	74	72716	MANILLON PLACA 727 LP	23
68192	CIERRE CORREDERA LLI/ 6847 ALUM BL	66	68292	KIT ABATIBLE 1 HOJA EUROPEO 6853 NE	74	72736	MANILLON PLACA 727 NS	23
68193	CIERRE CORREDERA LLI/ 6847 ALUM NE	66	68293	KIT ABATIBLE 2° HOJA EUROPEO 6853 NE	74	72999	JGO GUIA TELESCOPICA SOFT GC7 45x300mm ZN	216
68194	MANILLA FACHADA DCHA 6848 ALUM BL	68	68294	JGO MANILLON 6854 350mm BL	79	73000	JGO GUIA TELESCOPICA SOFT GC7 45x350mm ZN	216
68195	MANILLA FACHADA IZDA 6848 ALUM BL	68	68295	JGO MANILLON 6854 350mm NE	79	73001	JGO GUIA TELESCOPICA SOFT GC7 45x400mm ZN	216
68196	MANILLA FACHADA DCHA 6848 ALUM NE	68	68296	JGO MANILLON 6854 350mm EI	79	73002	JGO GUIA TELESCOPICA SOFT GC7 45x450mm ZN	216
68197	MANILLA FACHADA IZDA 6848 ALUM NE	68	68297	ASA CORREDERA 6862 ALUM BL	61	73003	JGO GUIA TELESCOPICA SOFT GC7 45x500mm ZN	216
68198	MANILLA FACHADA DCHA 6848 ALUM PL	68	68298	ASA CORREDERA 6862 ALUM NE	61	73004	JGO GUIA TELESCOPICA SOFT GC7 45x550mm ZN	216
68199	MANILLA FACHADA IZDA 6848 ALUM PL	68	68299	ASA CORREDERA 6862 ALUM PL	61	73005	JGO GUIA TELESCOPICA PUSH GC8 45x350mm ZN	216
68200	RODAMIENTO INASA 151 RD12 ZN	82	68300	MANILLA MULTIPUNTO 6855 ALUM BL	68	73006	JGO GUIA TELESCOPICA PUSH GC8 45x400mm ZN	216
68201	RODAMIENTO 157 RD13 BC	82	68301	MANILLA MULTIPUNTO 6855 ALUM NE	68	73007	JGO GUIA TELESCOPICA PUSH GC8 45x450mm ZN	216
68202	RODAMIENTO 158 RD14 BC	83	68302	CREMONA 2 PATILLAS 6856 ALUM BL	72	73008	JGO GUIA TELESCOPICA PUSH GC8 45x500mm ZN	216
68203	RODAMIENTO 158/S RD15 BC	83	68303	CREMONA 2 PATILLAS 6856 ALUM NE	72	73009	JGO GUIA TELESCOPICA PUSH GC8 45x550mm ZN	216
68204	RODAMIENTO INASA 162 RD16 ZN	83	68304	CIERRE PRESION 6857 ALUM BL	57	73012	JGO GUIA TELESCOPICA PUSH GC8 45x300mm ZN	216
68205	RODAMIENTO CLIMALIT 177 RD17 ZN	83	68305	CIERRE PRESION 6857 ALUM NE	57	73013	JGO GUIA TELESCOPICA SOFT GC7 45x600mm ZN	216
68206	RODAMIENTO INASA 163 RD9 BL	80	68306	JGO MANILLA CIEGA 6824 ALUM BL	58	73023	JGO GUIA TELESCOPICA SOFT-PUSH GC11 45x400mm ZN	217
68207	RODAMIENTO 172 RD7 BL	80	68307	JGO MANILLA CIEGA 6824 ALUM NE	58	73024	JGO GUIA TELESCOPICA SOFT-PUSH GC11 45x450mm ZN	217
68208	RODAMIENTO ENDASA CLL RD10 BL	80	68308	ASA PLACA CIEGA 6843 ALUM BL	58	73025	JGO GUIA TELESCOPICA SOFT-PUSH GC11 45x500mm ZN	217
68209	RODAMIENTO CLL/104 RD18 BC	84	68309	ASA PLACA CIEGA 6843 ALUM NE	58	73026	JGO GUIA TELESCOPICA SOFT-PUSH GC11 45x550mm ZN	217
68210	RODAMIENTO MAMPARA RD1 20mm NE	87	68310	JGO POMO PLACA CIEGA 6844 ALUM BL	59	73027	JGO GUIA TELESCOPICA SOFT-PUSH GC11 45x600mm ZN	217
68211	RODAMIENTO MAMPARA RD1 26mm NE	87	68311	JGO POMO PLACA CIEGA 6844 ALUM NE	59	73028	JGO GUIA TELESCOPICA SOFT-PUSH GC11 45x300mm ZN	217
68212	RODAMIENTO CO-22 RD8 BL	80	68312	CIERRE PRESION LLI/ DCHA 6858 ALUM BL	56	73029	JGO GUIA TELESCOPICA SOFT-PUSH GC11 45x350mm ZN	217
68213	TORNILLO RODAMIENTO RD1 M4x8mm IN	87	68313	CIERRE PRESION LLI/ IZDA 6858 ALUM BL	56	73030	JGO GUIA TELESCOPICA GC4 36x300mm ZN	215
68214	RUEDA SUPERIOR ARMARIO RUA1 NE	246	68314	CIERRE PRESION LLI/ DCHA 6858 ALUM NE	56	73035	JGO GUIA TELESCOPICA GC4 36x350mm ZN	215
68215	RUEDA SUPERIOR ARMARIO RUA2 ZN	246	68315	CIERRE PRESION LLI/ IZDA 6858 ALUM NE	56	73040	JGO GUIA TELESCOPICA GC4 36x400mm ZN	215
68216	RUEDA INFERIOR ARMARIO RUA3-M NE	246	68316	CIERRE CORREDERA LLI/ 6859 ALUM BL	64	73045	JGO GUIA TELESCOPICA GC4 36x450mm ZN	215
68217	RUEDA SUPERIOR ARMARIO RUA4 ZN	246	68317	CIERRE CORREDERA LLI/ 6859 ALUM NE	64	73050	JGO GUIA TELESCOPICA GC4 36x500mm ZN	215
68218	RUEDA INFERIOR ARMARIO RUA5-M ZN	247	68318	MANILLON 6860 350mm BL/NE	78	73251	SOPORTE CENTRAL OVAL STA7 25x15mm NI	232
68219	RUEDA INFERIOR ARMARIO RUA5-H ZN	247	68319	MANILLON 6860 350mm NE	78	73252	SOPORTE CENTRAL OVAL STA7 25x15mm LTD	232
68220	FRENO SUPERIOR ARMARIO RUA6 ZN	246	68320	MANILLON 6860 350mm PL/NE	78	73301	SOPORTE CENTRAL OVAL STA8 30x15mm NI	232
68221	RODAMIENTO MAMPARA RD1 16mm NE	87	68321	JGO MANILLON 6860 350mm BL/NE	78	73302	SOPORTE CENTRAL OVAL STA8 30x15mm LTD	232
68222	RODAMIENTO MAMPARA TUBO RD2 22mm BL	89	68322	JGO MANILLON 6860 350mm NE	78	73303	SOPORTE CENTRAL OVAL STA8 30x15mm AL	232
68223	RODAMIENTO MAMPARA TUBO RD2 24mm BL	89	68323	JGO MANILLON 6860 350mm PL/NE	78	73304	SOPORTE CENTRAL OVAL REG STA10 30x15mm CB	233
68224	RODAMIENTO MAMPARA ART RD3 26mm BL	89	68324	JGO MANILLON 6861 350mm BL	79	73305	SOPORTE CENTRAL OVAL REG STA10 30x15mm LTD	233
68225	RODAMIENTO ALUGOM 400 RD20 NE	81	68325	JGO MANILLON 6861 350mm NE	79	73306	SOPORTE CENTRAL OVAL REG STA10 30x15mm AL	233
68226	RODAMIENTO MOSQUITERA RD5 21mm NE	90	68326	MECANISMO INDIVIDUAL MANILLON 6861	79	73307	SOPORTE LATERAL N°7 STA20 12mm ZN	234
68227	RODAMIENTO MOSQUITERA RD5 23mm NE	90	68327	CREMONA FRONTAL 6863 ZAMAK BL/NE	73	73308	SOPORTE TECHO N°2 STA17 12mm ZN	234
68228	RODAMIENTO VITRINA RD29 ZN	85	68328	CIERRE PRESION DCHA 6864 ALUM PL	56	73309	SOPORTE FRENTE N°1 STA16 12mm ZN	235
68229	RODAMIENTO VITRINA RD30 NE	85	68329	CIERRE PRESION IZDA 6864 ALUM PL	56	73310	SOPORTE EXTENSIBLE N°4 STA18 12mm ZN	235
68230	RODAMIENTO REGULABLE INASA 2000 RD34 ZN	84	68330	CIERRE CORREDERA PULSAR 6865 ALUM BL	66	73311	SOPORTE EXTENSIBLE N°5 STA19 12mm ZN	235
68231	RODAMIENTO REGULABLE INASA 300 RD35 ZN	84	68331	CIERRE CORREDERA PULSAR 6865 ALUM NE	66	73312	SOPORTE DOBLE TECHO N°9 STA21 12mm ZN	235
68232	RODAMIENTO CO-1B RD31 AL	85	68332	CIERRE CORREDERA PULSAR 6865 ALUM PL	66	73313	REMATO TUBO BELLOTA CT1 12mm CB	236
68233	RODAMIENTO ALTA 300 RD11 BL	81	68333	MANILLON DESPLAZADO 6866 300mm PL	78	73314	ANILLA TUBO CT3 12mm CB	236
68234	RODAMIENTO ELITE VENTANA RD23 NE	82	68334	OVALILLO OV2 10x7x2mm LT	179	73315	SOPORTE FRENTE N°1 STA16 12mm BL	235
68235	RODAMIENTO TRIANA RD24 NE	82	68335	OVALILLO OV2 12x8x2mm LT	179	73316	SOPORTE TECHO N°2 STA17 12mm BL	234
68236	RODAMIENTO ALUPRON 21 RD21 NE	81	68336	OVALILLO OV2 14x9x3mm LT	179	73317	SOPORTE EXTENSIBLE N°4 STA18 12mm BL	235
68237	RODAMIENTO P-60 RD22 NE	81	68337	OVALILLO OV2 16x11x3mm LT	179	73318	REMATO TUBO BELLOTA CT1 12mm BL	236
68238	RODAMIENTO MAMPARA RD25 BL	88	68338	OVALILLO OV2 18x11x3mm LT	179	73319	ANILLA TUBO CT3 12mm BL	236
68239	RODAMIENTO MAMPARA RD26 BL	88	68339	OVALILLO OV2 20x12x3mm LT	179	73320	GANCHO CORTINA PEQUEÑO CT6 ZN	238
68240	RODAMIENTO MAMPARA RD27 BL	88	68340	CREMONA 2 PATILLAS 6829 ALUM PL	70	73321	GANCHO CORTINA GRANDE CT6 ZN	238
68241	RODAMIENTO MAMPARA RD28 BL	88	68341	ASA CIERRE OVAL 6849 ALUM PL	62	73322	CORCHETE CORTINA CT5 BL	237
68242	JGO ENGANCHE MOSQUITERA MQ1 BL	90	68342	BISAGRA 3 NUDOS EU 6868 ALUM BL	67	73323	SOPORTE CERRADO TECHO OVAL STA12 30x15mm AL	234
68243	JGO ENGANCHE MOSQUITERA MQ1 NE	90	68343	BISAGRA 3 NUDOS EU 6868 ALUM NE	67	73325	SOPORTE ESQUINA TECHO OVAL STA13 30x15mm AL	234
68244	ESTUCHE RODAMIENTOS RD41 SURTIDOS	79	68610	TIRADOR ARMARIO S/B 686 LE	20	73326	SOPORTE FRENTE N°1 STA16 16mm ZN	235
68245	KIT MOSQUITERA CORREDERA GDE MQ2 BL	90	68613	TIRADOR MALETERO 686 LE	20	73327	EMPALME TUBO ARMARIO TA5 12mm ZN	228
68246	KIT MOSQUITERA CORREDERA GDE MQ2 NE	90	68616	MANILLON ROSETA PORCELANA 686 LE	20	73328	ESPIRAL VISILLO FORRADO EV1 50mts BL	226
68247	KIT MOSQUITERA CORREDERA PEQ MQ2 BL	90	69401	CIERRE VENTANA P/BAJO CV1 62x44mm LT	129	73329	ANILLA TUBO CT3 16mm CB	236
68248	KIT MOSQUITERA CORREDERA PEQ MQ2 NE	90	69402	CUADRADILLO EXPANSION CDD3 8x65mm ZN	114	73330	ANILLA TUBO CT3 16mm BL	236
68249	TORNILLO RODAMIENTO RD1 M3x6mm IN	87	69405	PLACA CUADRADILLO FIJO CDD5 8mm ZN	115	73331	REMATO TUBO PINA CT2 12mm CB	236
68250	TORNILLO RODAMIENTO RD1 M5x8mm IN	87	69406	PLACA ESPARRAGO FIJO CDD6 8mm ZN	115	73332	REMATO TUBO PINA CT2 12mm BL	236
68251	RODAMIENTO MAMPARA RD1 20mm C/SEPARADOR 6mm NE	87	69421	TIRADOR EMBUTIR OVAL TE12 152x38mm LP	209	73333	REMATO TUBO PINA CT2 16mm CB	236
68252	RODAMIENTO MAMPARA RD1 20mm C/SEPARADOR 12mm NE	87	69424	TIRADOR EMBUTIR OVAL TE12 152x38mm NS	209	73334	REMATO TUBO PINA CT2 16mm BL	236
68253	RODAMIENTO MAMPARA RD1 20mm C/SEPARADOR 17mm NE	87	70121	SOPORTE LATERAL STA1 12mm NI	230	73335	TERMINAL ESPIRAL VISILLO EV2 NI	227
68254	RODAMIENTO MAMPARA RD1 26mm C/SEPARADOR 6mm NE	87	70161	SOPORTE LATERAL STA1 16mm NI	230	73336	GARFIO CORTINA FRENTE CT7 ZN	237
68255	RODAMIENTO MAMPARA RD1 26mm C/SEPARADOR 12mm NE	87	70191	SOPORTE LATERAL STA1 19mm NI	230	73337	GARFIO CORTINA TECHO CT8 ZN	237
68256	RODAMIENTO MAMPARA RD1 26mm C/SEPARADOR 17mm NE	87	70251	SOPORTE LATERAL STA4 25mm CB	231	73338	CORCHETE CORTINA CT9 ZN	237
68257	SEPARADOR P/RODAMIENTO MAMPARA RD1 6mm LT	87	70500	CAJON LATERAL SOFT GC13 80x270mm GR*	218	73339	CORCHETE CORTINA COSER CT12 BL	237
68258	SEPARADOR P/RODAMIENTO MAMPARA RD1 12mm LT	87	70501	CAJON LATERAL SOFT GC13 80x300mm GR*	218	73340	CORCHETE CORTINA COSER CT11 ZN	238
68259	SEPARADOR P/RODAMIENTO MAMPARA RD1 17mm LT	87	70502	CAJON LATERAL SOFT GC13 80x350mm GR*	218	73341	CORCHETE GUIA RIEL CT10 BL	238
68260	RODAMIENTO REGULABLE ALUGOM 400 RD36 ZN	86	70503	CAJON LATERAL SOFT GC13 80x400mm GR*	218	73342	ALFILER VISILLO CT13 ZN	238
68261	RODAMIENTO REGULABLE ALUPRON 21 RD37 ZN	86	70504	CAJON LATERAL SOFT GC13 80x450mm GR*	218	73343	PERFIL CORTINA C/CINTA MACHO CT14 3mts BL	239
68262	RODAMIENTO REGULABLE SILVER 60 RD38 ZN	86	70505	CAJON LATERAL SOFT GC13 80x500mm GR*	218	73344	PERFIL CORTINA C/CINTA MACHO CT14 3mts PL	239
68263	RODAMIENTO REGULABLE P60/P65 RD39 ZN	86	70530	JGO GUIA CUADRO SOFT PARCIAL GC9 300mm ZN	218	73345	CINTA CIERRE COSER MACHO CT15 20x25mts BL	239
68264	RODAMIENTO REGULABLE CORTIZO 5200 RD40 ZN	86	70535	JGO GUIA CUADRO SOFT PARCIAL GC9 350mm ZN	218	73346	CINTA CIERRE COSER HEMBRA CT15 20x25mts BL	239
68265	RODAMIENTO CO-36 RD32 ZN	85	70540	JGO GUIA CUADRO SOFT PARCIAL GC9 400mm ZN	218	73347	CINTA CIERRE ADH MACHO CT16 20x25mts BL	239
68266	RODAMIENTO CO-22 RD33 AL	85	70545	JGO GUIA CUADRO SOFT PARCIAL GC9 450mm ZN	218	73348	CINTA CIERRE ADH HEMBRA CT16 20x25mts BL	239
68267	RODAMIENTO CO-22 RD19 BC	84	70590	JGO GUIA CUADRO SOFT PARCIAL GC9 500mm ZN	218	73349	ANILLA REDONDA CT17 8mm BL	236
68268	JGO RODAMIENTO MAMPARA RD4 GR/BL	89	70630	JGO GUIA CUADRO SOFT TOTAL GC9 300mm ZN	218	73350	ANILLA REDONDA CT17 10mm BL	236
68269	RODAMIENTO MAMPARA ART RD6 21mm BL	89	70635	JGO GUIA CUADRO SOFT TOTAL GC9 350mm ZN	218	73351	ANILLA REDONDA CT17 13mm BL	236
68270	JGO MANILLA 6842 ALUM BL	54	70640	JGO GUIA CUADRO SOFT TOTAL GC9 400mm ZN	218	73352	ANILLA REDONDA CT17 16mm BL	236
68271	JGO MANILLA 6842 ALUM NE	54	70645	JGO GUIA CUADRO SOFT TOTAL GC9 450mm ZN	218	73353	ANILLA REDONDA CT17 18mm BL	236
68272	JGO MANILLA 6842 ALUM PL	54	70650	JGO GUIA CUADRO SOFT TOTAL GC9 500mm ZN	218	73354	ANILLA REDONDA CT17 20mm BL	236
68273	MANILLA MULTIPUNTO LLI/ 6806 ALUM BL	68	70716	MANILLON ROSETA 707 LS	36	73355	ANILLA REDONDA CT17 22mm BL	236
68274	MANILLA MULTIPUNTO LLI/ 6806 ALUM NE	68	70735	JGO GUIA CUADRO PUSH PARCIAL GC10 350mm ZN	218	73356	ANILLA REDONDA CT17 25mm BL	236
68275	ASA CIERRE OVAL 6849 ALUM BL	62	70736	MANILLON ROSETA 707 NS	36	73357	ANILLA REDONDA CT17 30mm BL	236
68276	ASA CIERRE OVAL 6849 ALUM NE	62	70740	JGO GUIA CUADRO PUSH PARCIAL GC10 400mm ZN	218	73358	TIRACORDON CORTINA C/CAJON GUERO CT18 BL	239
68277	BISAGRA 3 CUERPOS 40/20 6867 ALUM BL	67	70745	JGO GUIA CUADRO PUSH PARCIAL GC10 450mm ZN	218	74251	SOPORTE CERRADO OVAL STA9 25x15mm NI	233
68278	BISAGRA 3 CUERPOS 40/20 6867 ALUM NE	67	70750	JGO GUIA CUADRO PUSH PARCIAL GC10 500mm ZN	218	74301	SOPORTE CERRADO OVAL STA9 30x15mm NI	233
68279	ASA RECTA S/PLACA 6804 ALUM BL	60	70830	JGO GUIA CUADRO PUSH TOTAL GC10 300mm ZN	218	74303	SOPORTE CERRADO OVAL STA9 30x15mm AL	233
68280	ASA RECTA S/PLACA 6804 ALUM NE	60	70835	JGO GUIA CUADRO PUSH TOTAL GC10 350mm ZN	218	74304	SOPORTE CERRADO OVAL REG STA11 30x15mm CB	233
68281	ASA RECTA S/PLACA 6804 ALUM PL	60	70840	JGO GUIA CUADRO PUSH TOTAL GC10 400mm ZN	218	74305	SOPORTE CERRADO OVAL REG STA11 30x15mm LTD	233
68282	CERRADERO 40/20 6850 140x31,5mm BL	74	70845	JGO GUIA CUADRO PUSH TOTAL GC10 450mm ZN	218	74306	SOPORTE CERRADO OVAL REG STA11 30x15mm AL	233
68283	CERRADERO 40/20 6850 140x31,5mm NE	74	70850	JGO GUIA CUADRO PUSH TOTAL GC10 500mm ZN	218	75000	JGO GUIA CAJON GC12 250mm MA	212
68284	CERRADERO 40/20 6850 195x31,5mm BL	74	71121	SOPORTE CENTRAL STA2 12mm NI	230	75001	JGO GUIA CAJON GC12 330mm MA	212
68285	CERRADERO 40/20 6850 195x31,5mm NE	74	71161	SOPORTE CENTRAL STA2 16mm NI	230	75002	JGO GUIA CAJON GC1 250mm AL	213
68286	CERRADERO EUROPEO 6851 170x22mm BL	74	71191	SOPORTE CENTRAL STA2 19mm NI	230	75003	JGO GUIA CAJON GC1 300mm AL	213
68287	CERRADERO EUROPEO 6851 170x22mm NE	74	71251	SOPORTE CENTRAL REG STA5 25mm NI	231	75004	JGO GUIA CAJON GC1 350mm AL	213
68288	CERRADERO EUROPEO 6851 225x22mm BL	74	72121	SOPORTE CERRADO STA3 12mm NI	230	75005	JGO GUIA CAJON GC1 400mm AL	213

NUMÉRICO

Código	Descripción	Pág.	Código	Descripción	Pág.	Código	Descripción	Pág.
75006	JGO GUIA CAJON GC1 450mm AL	213	80047	SOPORTE HAMACA CERRADO AP2 BL	331	89021	POLEA TENDER C/TUERCA POL1 40mm ZN	412
75007	JGO GUIA CAJON GC1 500mm AL	213	80048	HEMBRILLA C/T SOLDADA HM1 M6x100mm ZN	332	89022	POLEA TENDER C/TUERCA POL1 60mm ZN	412
75008	JGO GUIA CAJON GC1 550mm AL	213	80049	HEMBRILLA C/T SOLDADA HM1 M8x100mm ZN	332	89023	TUBO RECTANGULAR VN1 110x55x1500mm BL	350
75009	JGO GUIA CAJON GC1 600mm AL	213	80050	SOPORTE HAMACA ABIERTO AP1 NE	331	89024	TUBO REDONDO VN2 100x1500mm BL	350
75010	ENGANCHE FRONTAL REG PICAJON ENG1 NI	213	80051	SOPORTE HAMACA CERRADO AP2 NE	331	89025	ARO REDUCTOR VN3 125-100mm BL	351
75025	JGO GUIA CAJON GC1 250mm BL	213	80052	ANILLA SOLDADA C/HEMBRILLA AP4 ZN	330	89026	EMPALME REDONDO VN4 100mm BL	351
75030	JGO GUIA CAJON GC1 300mm BL	213	80053	ANILLA SOLDADA C/HEMBRILLA AP4 NE	330	89027	EMPALME RECTANGULAR VN5 110x55mm BL	351
75035	JGO GUIA CAJON GC1 350mm BL	213	80054	ANILLA SOLDADA C/PLACA AP6 ZN	330	89028	EMPALME MIXTO VN6 100/110x55mm BL	351
75040	JGO GUIA CAJON GC1 400mm BL	213	80055	ANILLA SOLDADA C/PLACA AP6 NE	330	89029	CODO 90° REDONDO VN9 100mm BL	352
75045	JGO GUIA CAJON GC1 450mm BL	213	80056	GANCHO C/PLACA FIJO AP7 ZN	330	89030	CODO 90° MIXTO VN12 100/110x55mm BL	354
75050	JGO GUIA CAJON GC1 500mm BL	213	80057	GANCHO C/PLACA FIJO AP7 NE	330	89031	CODO 90° VERTICAL VN10 110x55mm BL	354
75055	JGO GUIA CAJON GC1 550mm BL	213	80058	GANCHO C/PLACA MOVIL AP5 ZN	330	89032	CODO 90° HORIZONTAL VN11 110x55mm BL	354
75060	JGO GUIA CAJON GC1 600mm BL	213	80059	GANCHO C/PLACA MOVIL AP5 NE	330	89033	VENTANILLA SALIDA REDONDA VN17 100mm BL	355
75080	JGO GUIA CAJON GC1 800mm BL	213	80060	ANILLA C/PLACA TOLDOS AP3 ZN	331	89034	VENTANILLA SALIDA RECTANGULAR VN18 110x55mm BL	355
75251	SOPORTE LATERAL OVAL STA6 NI	232	80061	ANILLA C/PLACA TOLDOS AP3 AISI316	331	89035	EMBELLECEDOR REDONDO VN15 100mm BL	353
75252	SOPORTE LATERAL OVAL STA6 LTD	232	80062	PLACA AMARRE REDONDA AP8 33mm AISI316	329	89036	EMBELLECEDOR RECTANGULAR VN16 110x55mm BL	353
75253	SOPORTE LATERAL OVAL STA6 AL	232	80063	PLACA AMARRE REDONDA AP8 40mm AISI316	329	89037	ABRAZADERA REDONDA VN13 100mm BL	353
75254	SOPORTE LATERAL OVAL STA6 BL	232	80064	PLACA AMARRE REDONDA AP8 50mm AISI316	329	89038	ABRAZADERA RECTANGULAR VN14 110x55mm BL	353
75255	SOPORTE LATERAL STOR STA14 14mm BC	231	80065	PLACA AMARRE REDONDA C/ANILLA AP9 33mm AISI316	329	89039	REJILLA MOSQUITERA RJV4 150x150mm AL	356
75256	SOPORTE LATERAL STOR STA14 18mm BC	231	80066	PLACA AMARRE REDONDA C/ANILLA AP9 40mm AISI316	329	89040	REJILLA MOSQUITERA RJV4 170x170mm AL	356
75257	SOPORTE LATERAL STOR STA14 22mm BC	231	80067	PLACA AMARRE REDONDA C/ANILLA AP9 50mm AISI316	329	89041	REJILLA MOSQUITERA RJV4 200x200mm AL	356
76025	JGO GUIA CAJON GC1 250mm MA	213	80068	PLACA AMARRE OVAL AP10 45x17mm AISI316	329	89042	REJILLA MOSQUITERA RJV4 150x150mm BL	356
76030	JGO GUIA CAJON GC1 300mm MA	213	80069	PLACA AMARRE OVAL AP10 60x20mm AISI316	329	89043	REJILLA MOSQUITERA RJV4 170x170mm BL	356
76035	JGO GUIA CAJON GC1 350mm MA	213	80070	PLACA AMARRE OVAL AP10 80x26mm AISI316	329	89044	REJILLA MOSQUITERA RJV4 200x200mm BL	356
76040	JGO GUIA CAJON GC1 400mm MA	213	80071	PLACA AMARRE OVAL C/ANILLA AP11 45x17mm AISI316	329	89045	POLEA PUERTA CORREDERA POL8 25mm LT	247
76045	JGO GUIA CAJON GC1 450mm MA	213	80072	PLACA AMARRE OVAL C/ANILLA AP11 60x20mm AISI316	329	89046	POLEA PUERTA CORREDERA POL8 35mm LT	247
76050	JGO GUIA CAJON GC1 500mm MA	213	80073	PLACA AMARRE OVAL C/ANILLA AP11 80x26mm AISI316	329	89047	TUBO RECTANGULAR VN1 147x70x1500mm BL	350
76055	JGO GUIA CAJON GC1 550mm MA	213	80074	HEMBRILLA C/T SOLDADA HM1 M3x30mm IN	332	89048	TUBO REDONDO VN2 120x1500mm BL	350
76060	JGO GUIA CAJON GC1 600mm MA	213	80075	HEMBRILLA C/T SOLDADA HM1 M4x40mm IN	332	89049	ARO REDUCTOR VN3 125-120mm BL	351
76080	JGO GUIA CAJON GC1 800mm MA	213	80076	HEMBRILLA C/T SOLDADA HM1 M5x50mm IN	332	89050	EMPALME REDONDO VN4 120mm BL	351
77182	JGO MICROGUIA GC2 17x182mm ZN	214	80077	HEMBRILLA C/T SOLDADA HM1 M6x60mm IN	332	89051	EMPALME RECTANGULAR VN5 147x70mm BL	351
77214	JGO MICROGUIA GC2 17x214mm ZN	214	80078	HEMBRILLA C/T SOLDADA HM1 M8x80mm IN	332	89052	EMPALME MIXTO VN6 120/147x70mm BL	351
77246	JGO MICROGUIA GC2 17x246mm ZN	214	80079	HEMBRILLA C/T SOLDADA HM1 M10x100mm IN	332	89053	CODO 90° REDONDO VN9 120mm BL	352
77278	JGO MICROGUIA GC2 17x278mm ZN	214	80080	HEMBRILLA C/T ABIERTA HM2 M3x30mm IN	332	89054	CODO 90° MIXTO VN12 120/147x70mm BL	354
77310	JGO MICROGUIA GC2 17x310mm ZN	214	80081	HEMBRILLA C/T ABIERTA HM2 M4x40mm IN	332	89055	CODO 90° VERTICAL VN10 147x70mm BL	354
77342	JGO MICROGUIA GC2 17x342mm ZN	214	80082	HEMBRILLA C/T ABIERTA HM2 M5x50mm IN	332	89056	CODO 90° HORIZONTAL VN11 147x70mm BL	354
77374	JGO MICROGUIA GC2 17x374mm ZN	214	80083	HEMBRILLA C/T ABIERTA HM2 M6x60mm IN	332	89057	VENTANILLA SALIDA REDONDA VN17 120mm BL	355
77406	JGO MICROGUIA GC2 17x406mm ZN	214	80084	HEMBRILLA C/T ABIERTA HM2 M8x80mm IN	332	89058	VENTANILLA SALIDA RECTANGULAR VN18 147x70mm BL	355
77438	JGO MICROGUIA GC2 17x438mm ZN	214	80100	PALOMILLA CLASICA PLM1 100x75mm BL	306	89059	EMBELLECEDOR REDONDO VN15 120mm BL	353
77470	JGO MICROGUIA GC2 17x470mm ZN	214	80125	PALOMILLA CLASICA PLM1 125x100mm BL	306	89060	EMBELLECEDOR RECTANGULAR VN16 147x70mm BL	353
77502	JGO MICROGUIA GC2 17x502mm ZN	214	80150	PALOMILLA CLASICA PLM1 150x125mm BL	306	89061	ABRAZADERA REDONDA VN13 120mm BL	353
77710	TIRADOR ARMARIO S/B 777 LP	29	80175	PALOMILLA CLASICA PLM1 175x150mm BL	306	89062	ABRAZADERA RECTANGULAR VN14 147x70mm BL	353
77711	PLACA LIMPIEZA 777 LP	28	80200	PALOMILLA CLASICA PLM1 200x150mm BL	306	89063	ARO REDUCTOR VN3 150-120mm BL	351
77713	TIRADOR MALETERO 777 LP	29	80250	PALOMILLA CLASICA PLM1 250x200mm BL	306	89064	CODO 45° REDONDO VN7 100mm BL	352
77716	MANILLON PLACA 777 LP	28	80300	PALOMILLA CLASICA PLM1 300x250mm BL	306	89065	CODO 45° HORIZONTAL VN8 110x55mm BL	352
78025	JGO GUIA TELESCOPICA GC5 45x250mm ZN	215	80350	PALOMILLA CLASICA PLM1 350x300mm BL	306	89066	CODO 45° REDONDO VN7 120mm BL	352
78030	JGO GUIA TELESCOPICA GC5 45x300mm ZN	215	80400	PALOMILLA CLASICA PLM1 400x350mm BL	306	89067	CODO 45° HORIZONTAL VN8 147x70mm BL	352
78035	JGO GUIA TELESCOPICA GC5 45x350mm ZN	215	80450	PALOMILLA CLASICA PLM1 450x400mm BL	306	89068	CARRIL SUELO POL10 2mts LTD	247
78040	JGO GUIA TELESCOPICA GC5 45x400mm ZN	215	80451	SOPORTE MICROONDAS MCR2 40kgs BL	343	89069	CARRIL SUELO POL10 2mts GV	247
78045	JGO GUIA TELESCOPICA GC5 45x450mm ZN	215	80452	SOPORTE MICROONDAS MCR2 40kgs GR	343	89070	POLEA TENDER C/GANCHO POL6 40mm ZN	411
78050	JGO GUIA TELESCOPICA GC5 45x500mm ZN	215	80453	PALOMILLA PLUS PLM2 150x125mm BL	306	89071	POLEA TENDER C/GANCHO POL5 40mm ZN	411
78055	JGO GUIA TELESCOPICA GC5 45x550mm ZN	215	80454	PALOMILLA PLUS PLM2 200x150mm BL	306	89072	TUBO RECTANGULAR VN1 170x90x1500mm BL	350
78060	JGO GUIA TELESCOPICA GC5 45x600mm ZN	215	80455	PALOMILLA PLUS PLM2 250x200mm BL	306	89073	TUBO REDONDO VN2 150x1500mm BL	350
78070	JGO GUIA TELESCOPICA GC5 45x700mm ZN	215	80456	PALOMILLA PLUS PLM2 300x250mm BL	306	89074	EMPALME REDONDO VN4 150mm BL	351
78080	JGO GUIA TELESCOPICA GC5 45x800mm ZN	215	80457	PALOMILLA PLUS PLM2 350x300mm BL	306	89075	EMPALME RECTANGULAR VN5 170x90mm BL	351
78090	JGO GUIA TELESCOPICA GC5 45x900mm ZN	215	80458	PALOMILLA PLUS PLM2 150x125mm NE	306	89076	EMPALME MIXTO VN6 150/170x90mm BL	351
78100	JGO GUIA TELESCOPICA GC5 45x1000mm ZN	215	80459	PALOMILLA PLUS PLM2 200x150mm NE	306	89077	CODO 90° REDONDO VN9 150mm BL	352
78110	JGO GUIA TELESCOPICA GC6 53x1050mm ZN	217	80460	PALOMILLA PLUS PLM2 250x200mm NE	306	89078	CODO 90° MIXTO VN12 150/170x90mm BL	354
78130	JGO GUIA TELESCOPICA GC6 53x300mm ZN	217	80461	PALOMILLA PLUS PLM2 300x250mm NE	306	89079	CODO 90° VERTICAL VN10 170x90mm BL	354
78140	JGO GUIA TELESCOPICA GC6 53x400mm ZN	217	80462	PALOMILLA PLUS PLM2 350x300mm NE	306	89080	CODO 90° HORIZONTAL VN11 170x90mm BL	354
78150	JGO GUIA TELESCOPICA GC6 53x500mm ZN	217	80463	PALOMILLA PLUS PLM2 150x125mm GR	306	89081	VENTANILLA MIXTA VN19 150/170x90mm BL	355
78160	JGO GUIA TELESCOPICA GC6 53x600mm ZN	217	80464	PALOMILLA PLUS PLM2 200x150mm GR	306	89082	POLEA SUPERIOR ESCUADRA POL9 BC	247
78170	JGO GUIA TELESCOPICA GC6 53x700mm ZN	217	80465	PALOMILLA PLUS PLM2 250x200mm GR	306	89083	TENDEDERO PARED TND1 550x20mm BL	411
78180	JGO GUIA TELESCOPICA GC6 53x800mm ZN	217	80466	PALOMILLA PLUS PLM2 300x250mm GR	306	89084	TENDEDERO PARED TND1 550x20mm NE	411
78190	JGO GUIA TELESCOPICA GC6 53x900mm ZN	217	80467	PALOMILLA PLUS PLM2 350x300mm GR	306	89085	TENDEDERO BALCON TND2 550x20mm BL	411
78736	MANILLON ROSETA PORCELANA 787 LE	21	80468	PALOMILLA ALUMINIO PLM7 150x100mm BL	306	89086	TENDEDERO BALCON TND2 550x20mm NE	411
78746	MANILLON ROSETA PORCELANA 787 CU	21	80469	PALOMILLA ALUMINIO PLM7 200x150mm BL	306	89087	POLEA TENDER C/TUERCA POL7 40mm IN	412
78796	MANILLON ROSETA PORCELANA 787 PE*	21	80470	PALOMILLA ALUMINIO PLM7 250x200mm BL	306	90004	SEGURO PERSIANA PR9 120x25x8mm BL	393
79182	JGO MICROGUIA GC3 27x182mm ZN	214	80471	PALOMILLA ALUMINIO PLM7 300x200mm BL	306	90005	SEGURO PERSIANA PR9 120x25x8mm NE	393
79214	JGO MICROGUIA GC3 27x214mm ZN	214	80472	PALOMILLA ALUMINIO PLM7 150x100mm NE	306	90006	SEGURO PERSIANA PR9 120x25x8mm CB	393
79246	JGO MICROGUIA GC3 27x246mm ZN	214	80473	PALOMILLA ALUMINIO PLM7 200x150mm NE	306	90007	RECOGEDOR EMBUTIR PR1 14mm BL	388
79278	JGO MICROGUIA GC3 27x278mm ZN	214	80474	PALOMILLA ALUMINIO PLM7 250x200mm NE	306	90008	RECOGEDOR EMBUTIR PR1 14mm GR	388
79310	JGO MICROGUIA GC3 27x310mm ZN	214	80475	PALOMILLA ALUMINIO PLM7 300x200mm NE	306	90009	RECOGEDOR EMBUTIR PR1 14mm MA	388
79342	JGO MICROGUIA GC3 27x342mm ZN	214	80476	PALOMILLA ALUMINIO PLM7 150x100mm GR	306	90010	RECOGEDOR EMBUTIR PR1 18mm BL	388
79374	JGO MICROGUIA GC3 27x374mm ZN	214	80477	PALOMILLA ALUMINIO PLM7 200x150mm GR	306	90011	RECOGEDOR EMBUTIR PR1 18mm GR	388
79406	JGO MICROGUIA GC3 27x406mm ZN	214	80478	PALOMILLA ALUMINIO PLM7 250x200mm GR	306	90012	RECOGEDOR EMBUTIR PR1 18mm MA	388
79438	JGO MICROGUIA GC3 27x438mm ZN	214	80479	PALOMILLA ALUMINIO PLM7 300x200mm GR	306	90013	RECOGEDOR ABATIBLE PR2 14mm BL	388
79470	JGO MICROGUIA GC3 27x470mm ZN	214	81834	POMO ARMARIO CUADRADO PA4 16mm NS	202	90014	RECOGEDOR ABATIBLE PR2 14mm GR	388
79502	JGO MICROGUIA GC3 27x502mm ZN	214	83839	MULETILLA ROSETA CUADRADA 616 35mm NS	51	90015	RECOGEDOR ABATIBLE PR2 14mm MA	388
80026	PUNTA LATON PNT2 1,2x11mm LT	189	85010	PERNIO S/R DCHA PN6 100x57mm LTD*	178	90016	RECOGEDOR ABATIBLE PR2 14mm MF	388
80027	PUNTA LATON PNT2 1,5x13mm LT	189	85011	PERNIO S/R IZDA PN6 100x57mm LTD*	178	90017	RECOGEDOR ABATIBLE PR2 18mm BL	388
80028	PUNTA LATON PNT2 1,5x18mm LT	189	89001	REJILLA EMPOTRAR RJV3 120x240mm BL	356	90018	RECOGEDOR ABATIBLE PR2 18mm GR	388
80029	PUNTILLA C/PERDIDA PNT1 0,9x25mm ZN	116	89002	REJILLA EMPOTRAR RJV3 160x160mm AL	356	90019	RECOGEDOR ABATIBLE PR2 18mm MA	388
80030	HEMBRILLA C/T SOLDADA HM1 M3x30mm ZN	332	89003	REJILLA EMPOTRAR RJV3 160x160mm BL	356	90020	RECOGEDOR ABATIBLE PR2 18mm MF	388
80031	HEMBRILLA C/T SOLDADA HM1 M4x40mm ZN	332	89005	REJILLA PLANA RJV2 150x300mm AL	356	90021	RECOGEDOR PLASTICO PEQUEÑO PR4 BL	389
80032	HEMBRILLA C/T SOLDADA HM1 M5x50mm ZN	332	89006	REJILLA PLANA RJV2 150x300mm BL	356	90022	RECOGEDOR PLASTICO GRANDE PR4 BL	389
80033	HEMBRILLA C/T SOLDADA HM1 M6x60mm ZN	332	89007	REJILLA PLANA RJV2 150x300mm NO	356	90023	RECOGEDOR METALICO PR5 ZN	389
80034	HEMBRILLA C/T SOLDADA HM1 M8x80mm ZN	332	89008	REJILLA PLANA RJV2 150x150mm AL	356	90024	EMBELLECEDOR P/RECOGEDOR PR6 AL	389
80035	HEMBRILLA C/T SOLDADA HM1 M10x70mm ZN	332	89009	REJILLA PLANA RJV2 170x170mm AL	356	90025	EMBELLECEDOR P/RECOGEDOR PR6 BL	389
80036	HEMBRILLA C/T SOLDADA HM1 M12x80mm ZN	332	89010	REJILLA PLANA RJV2 200x200mm AL	356	90026	EMBELLECEDOR P/RECOGEDOR PR6 OR	389
80037	HEMBRILLA C/T ABIERTA HM2 M3x30mm ZN	332	89011	REJILLA PLANA RJV2 150x300mm BL	356	90027	EMBELLECEDOR P/RECOGEDOR PR6 BR	389
80038	HEMBRILLA C/T ABIERTA HM2 M4x40mm ZN	332	89012	REJILLA PLANA RJV2 170x170mm BL	356	90028	CAJETIN OBRA PLASTICO PEQ PR3 NE	389
80039	HEMBRILLA C/T ABIERTA HM2 M5x50mm ZN	332	89013	REJILLA PLANA RJV2 200x200mm BL	356	90029	CAJETIN OBRA PLASTICO GDE PR3 NE	389
80040	HEMBRILLA C/T ABIERTA HM2 M6x60mm ZN	332	89014	REJILLA PLANA RJV2 150x150mm NO	356	90030	GUIA CINTA PERSIANA PLASTICO PR10 BL	390
80041	HEMBRILLA C/T ABIERTA HM2 M8x80mm ZN	332	89015	REJILLA PLANA RJV2 170x170mm NO	356	90031	GUIA CINTA PERSIANA METALICA PR11 BL	390
80042	HEMBRILLA C/T ABIERTA HM2 M10x70mm ZN	332	89016	REJILLA PLANA RJV2 200x200mm NO	356	90032	GUIA CINTA PERSIANA METALICA PR11 AL	390
80043	HEMBRILLA C/T ABIERTA HM2 M12x80mm ZN	332	89017	POLEA TENDER TORNILLO POL4 40mm ZN	412	90033	CARCSA GUIA CINTA PR12 BL	390
80044								

NUMÉRICO

Código	Descripción	Pág.	Código	Descripción	Pág.	Código	Descripción	Pág.
90037	SOPORTE PINCHO PR14 ZN	391	90174	BL PASADOR HIERRO PS1 50mm NI	134	90312	BL PUNTA LATON PNT2 1,2x11mm LT	189
90038	SOPORTE RODILLOS PR13 ZN	390	90175	BL PASADOR HIERRO PS1 60mm NI	134	90313	BL PUNTA LATON PNT2 1,5x13mm LT	189
90039	TORNO PERSIANA EMPOTRAR PR17 BL	392	90176	BL PASADOR HIERRO PS1 30mm LTD	134	90314	BL PUNTA LATON PNT2 1,5x18mm LT	189
90040	MANILLA P/TORNO PERSIANA PR17 BL	392	90177	BL PASADOR HIERRO PS1 35mm LTD	134	90315	BL JGO ESCUADRAS CG3+PLACA COLGAR CG2 ZN	323
90041	TOPE PERSIANA PR8 40mm BL	394	90178	BL PASADOR HIERRO PS1 40mm LTD	134	90316	BL JGO GANCHO CG1+PLACA COLGADOR CG2 ZN	322
90042	TOPE PERSIANA PR8 40mm GR	394	90179	BL PASADOR HIERRO PS1 50mm LTD	134	90317	BL JGO BIVALENTE CG4+PLACA COLGAR CG2 BL	323
90043	TOPE PERSIANA PR8 40mm MA	394	90180	BL PASADOR HIERRO PS1 60mm LTD	134	90318	BL JGO BIVALENTE CG4+PLACA COLGAR CG2 BE	323
90044	TOPE PERSIANA PR8 40mm MF	394	90181	BL PASADOR PORTACANDADO PS12 70mm BC	136	90319	BL TORNILLO ENSAMBLE TNE1 5x50mm ZN	279
90045	TOPE PERSIANA PR8 60mm BL	394	90182	BL PASADOR PORTACANDADO PS12 85mm BC	136	90320	BL TORNILLO ENSAMBLE TNE1 7x50mm ZN	279
90046	TOPE PERSIANA PR8 60mm GR	394	90197	BL CUÑA DE MADERA PRC4 75x35mm	118	90321	BL JGO TORNILLO UNION KOMBY TNE4 M6 LTD	281
90047	TOPE PERSIANA PR8 60mm MA	394	90198	BL CUÑA NIVELADORA NV11 100x20x8mm MA	287	90322	BL JGO TORNILLO UNION KOMBY TNE4 M6 NI	281
90048	TOPE PERSIANA PR8 60mm MF	394	90204	BL TORNILLO MULTICORTE TRN7 M4x45mm BC	210	90324	BL TUERCA TNE9+ESPARRAGO TNE10 1/4x30mm LT	280
90049	CINTA PERSIANA PR26 14x6mts BL	396	90205	BL TORNILLO TRN10+TUERCA SILLA TRC8 3/16x50mm NI	282	90329	BL TUERCA TNE9+ESPARRAGO TNE10 1/4x30mm NI	280
90050	CINTA PERSIANA PR26 14x6mts GR	396	90206	BL TORNILLO ANCLAJE TRN6 M6x30mm BC	283	90333	BL TORNILLO ENSAMBLE TNE8 26-36mm BL	280
90051	CINTA PERSIANA PR26 14x6mts MA	396	90207	BL TORNILLO DOWELL TRN9 M4x20mm ZN	282	90334	BL TORNILLO ENSAMBLE TNE8 34-44mm BL	280
90052	CINTA PERSIANA PR26 14x6mts BE	396	90208	BL TORNILLO DOWELL TRN9 M6x70mm ZN	282	90335	BL TORNILLO ENSAMBLE TNE8 26-36mm MA	280
90053	CINTA PERSIANA PR26 14x6mts BL/PINTAS	396	90209	BL TORNILLO BISAGRA TRN5 3,5x16mm NI	196	90336	BL TORNILLO ENSAMBLE TNE8 34-44mm MA	280
90056	CINTA PERSIANA PR26 18x6mts BL	396	90210	BL TORNILLO BISAGRA TRN5 4,0x16mm NI	196	90341	BL ESPIGA MADERA EN55 6x30mm	285
90057	CINTA PERSIANA PR26 18x6mts BL/PINTAS	396	90220	BL TUERCA CIEGA TRC1 M4x7x6,5mm LT	294	90342	BL ESPIGA MADERA EN55 8x40mm	285
90058	CINTA PERSIANA PR26 18x6mts GR	396	90221	BL TUERCA CIEGA TRC1 M4x7x6,5mm NI	294	90343	BL ESPIGA MADERA EN55 10x40mm	285
90059	CINTA PERSIANA PR26 18x6mts BE	396	90222	BL TUERCA CIEGA TRC1 M5x8x7mm LT	294	90344	BL GALLETA MADERA EN59 N°20	284
90060	CINTA PERSIANA PR26 22x6mts BL	396	90223	BL TUERCA CIEGA TRC1 M5x8x7mm NI	294	90347	BL PORTAESTANTE+CASQUILLO PE12 LTD	268
90061	CINTA PERSIANA PR26 22x6mts GR/BL	396	90224	BL TUERCA CIEGA TRC1 M6x10x8mm LT	294	90348	BL PORTAESTANTE+CASQUILLO ROSCADO PE13 LT	268
90062	CINTA PERSIANA PR26 22x6mts BE/BL	396	90225	BL TUERCA CIEGA TRC1 M6x10x8mm NI	294	90349	BL PORTAESTANTE+CASQUILLO ROSCADO PE13 NI	268
90063	CINTA PERSIANA PR26 14x50mts BL	396	90228	BL TUERCA CIEGA TRC1 M8x12x10mm LT	294	90350	BL PORTAESTANTE REDONDO PE14 14x4mm LT	268
90064	CINTA PERSIANA PR26 14x50mts GR	396	90229	BL TUERCA CIEGA TRC1 M8x12x10mm NI	294	90351	BL PORTAESTANTE REDONDO PE14 14x4mm NI	268
90065	CINTA PERSIANA PR26 14x50mts BE	396	90230	BL TUERCA CIEGA TRC1 M10x13x12mm LT	294	90352	BL PORTAESTANTE ARANDELA PE3 5x16mm LTD	265
90066	CINTA PERSIANA PR26 18x50mts BL	396	90231	BL TUERCA CIEGA TRC1 M10x13x12mm NI	294	90353	BL PORTAESTANTE ARANDELA PE3 5x16mm ZN	265
90067	CINTA PERSIANA PR26 18x50mts GR	396	90232	BL TAPON PASACABLES TPC1 60x22mm GR	219	90355	BL PORTAESTANTE C/GOMA PE10 5mm LT	269
90068	CINTA PERSIANA PR26 18x50mts BE	396	90233	BL TAPON PASACABLES TPC1 80x22mm GR	219	90356	BL PORTAESTANTE C/GOMA PE10 5mm NI	269
90069	CINTA PERSIANA PR26 22x50mts BL	396	90234	BL TAPON PASACABLES TPC1 60x22mm NE	219	90358	BL PORTAESTANTE VENTOSA PE15 5mm NI	269
90070	CINTA PERSIANA PR26 22x50mts GR/BL	396	90235	BL TAPON PASACABLES TPC1 80x22mm NE	219	90359	BL PORTAESTANTE SAFETY PE6 5mm BL	266
90071	CINTA PERSIANA PR26 22x50mts BE/BL	396	90236	BL SOPORTE LATERAL STA1 19mm NI	230	90360	BL PORTAESTANTE SAFETY PE6 5mm MA	266
90072	EMBELLECEDOR P/TORNO PR17 AL	392	90237	BL SOPORTE LATERAL STA1 16mm NI	230	90361	BL PORTAESTANTE SAFETY PE6 5mm TR	266
90073	MECANISMO TORNO PERSIANA EMPOTRAR PR17	392	90238	BL SOPORTE LATERAL STA1 12mm NI	230	90362	BL PORTAESTANTE VITRINA GDE PE5 BL	264
90074	TIRANTE C/FEJE PR18 GR	393	90239	BL SOPORTE LATERAL STA1+CENTRAL STA2 19mm NI	230	90363	BL PORTAESTANTE VITRINA PEQ PE5 BL	264
90075	POLEA METALICA PR19 180mm ZN	395	90240	BL SOPORTE LATERAL STA1+CENTRAL STA2 16mm NI	230	90364	BL PORTAESTANTE VITRINA GDE PE5 MA	264
90076	CONTERA METALICA PR20 57mm ZN	395	90241	BL SOPORTE LATERAL STA1+CENTRAL STA2 12mm NI	230	90365	BL PORTAESTANTE VITRINA PEQ PE5 MA	264
90077	POLEA PLASTICO P/RODAMIENTO CINTA 18mm PR21 NE	394	90242	BL SOPORTE LATERAL OVAL STA6 NI	232	90366	BL PORTAESTANTE VITRINA GDE PE5 BE	264
90078	POLEA PLASTICO ESPIGA CINTA 18mm PR21 NE	394	90243	BL SOPORTE LATERAL OVAL STA6 LTD	232	90367	BL PORTAESTANTE VITRINA PEQ PE5 BE	264
90079	SEGURO PERSIANA PASADOR PR22 6x80mm BC	393	90244	BL SOPORTE LATERAL OVAL STA6 AL	232	90368	BL PORTAESTANTE+CASQUILLO ESCUADRA PE8 BL	266
90080	SEGURO PERSIANA PASADOR PR22 6x150mm BC	393	90247	BL SOPORTE LATERAL OVAL STA15 17mm BL	231	90369	BL PORTAESTANTE+CASQUILLO ESCUADRA PE8 MA	266
90081	LAMA PERSIANA PR24 39x2mts BL	395	90248	BL SOPORTE LATERAL OVAL STA15 17mm MA	231	90370	BL TOPE 2 PUNTAS PQUEÑO TP1M1 BL	264
90082	LAMA PERSIANA PR24 52x2mts BL	395	90249	BL SOPORTE LATERAL STA6+CENTRAL OVAL STA7 25x15mm NI	232	90371	BL TOPE 2 PUNTAS GRANDE TP1M1 BL	264
90083	LAMA PERSIANA PR24 39x2mts MF	395	90250	BL SOPORTE LATERAL STA6+CENTRAL OVAL STA7 25x15mm LTD	232	90372	BL TOPE 2 PUNTAS PQUEÑO TP1M1 MA	264
90084	LAMA PERSIANA PR24 52x2mts MF	395	90251	BL SOPORTE LATERAL STA6+CENTRAL OVAL STA8 30x15mm NI	232	90373	BL TOPE 2 PUNTAS GRANDE TP1M1 MA	264
90085	LAMA PERSIANA FINAL PR24 39x2mts BL	395	90252	BL SOPORTE LATERAL STA6+CENTRAL OVAL STA8 30x15mm LTD	232	90374	BL DESLIZANTE CLAVO DZ1 15mm BL	286
90086	LAMA PERSIANA FINAL PR24 52x2mts BL	395	90253	BL SOPORTE LATERAL STA6+CENTRAL OVAL STA8 30x15mm AL	232	90375	BL DESLIZANTE CLAVO DZ1 17mm BL	286
90087	LAMA PERSIANA FINAL PR24 39x2mts MF	395	90254	BL SOPORTE CENTRAL STA2 12mm NI	230	90377	BL DESLIZANTE CLAVO DZ1 15mm MA	286
90088	LAMA PERSIANA FINAL PR24 52x2mts MF	395	90255	BL SOPORTE CENTRAL STA2 16mm NI	230	90378	BL DESLIZANTE CLAVO DZ1 17mm MA	286
90089	CUERDA P/TORNO PERSIANA PR17 6mts BL	393	90256	BL SOPORTE CENTRAL STA2 19mm NI	230	90380	BL EMBELLECEDOR LISO SC1 12mm LT	296
90090	CONTERA METALICA PR20 42mm ZN	395	90257	BL SOPORTE CERRADO STA3 12mm NI	230	90381	BL EMBELLECEDOR LISO SC1 14mm LT	296
90091	TUBO EJE OCTOGONAL PR23 42x2mts GV	395	90258	BL SOPORTE CERRADO STA3 16mm NI	230	90382	BL EMBELLECEDOR LISO SC1 16mm LT	296
90092	TUBO EJE OCTOGONAL PR23 57x2mts GV	395	90259	BL SOPORTE CERRADO STA3 19mm NI	230	90383	BL EMBELLECEDOR LISO SC1 18mm LT	296
90093	SEGURO PERSIANA CUÑA DENTADA PR25 IN	393	90260	BL SOPORTE CENTRAL OVAL STA7 25x15mm NI	232	90384	BL EMBELLECEDOR LISO SC1 12mm NI	296
90101	BL MIRILLA 14mm 180° MR1 25/42mm LTD	96	90261	BL SOPORTE CENTRAL OVAL STA7 25x15mm LTD	232	90385	BL EMBELLECEDOR LISO SC1 14mm NI	296
90102	BL MIRILLA MR1 35/60mm+EMBELLECEDOR MR3 LTD	97	90262	BL SOPORTE CENTRAL OVAL STA8 30x15mm NI	232	90386	BL EMBELLECEDOR LISO SC1 16mm NI	296
90103	BL MIRILLA 14mm 180° MR1 35/60mm LTD	96	90263	BL SOPORTE CENTRAL OVAL STA8 30x15mm LTD	232	90387	BL EMBELLECEDOR LISO SC1 18mm NI	296
90106	BL MIRILLA 14mm 180° MR1 35/60mm CU	96	90264	BL SOPORTE CENTRAL OVAL STA8 30x15mm AL	232	90388	BL EMBELLECEDOR FACETADO SC2 12mm LT	296
90108	BL MIRILLA 14mm 180° MR1 25/42mm NS	96	90265	BL SOPORTE CERRADO OVAL STA9 25x15mm NI	233	90389	BL EMBELLECEDOR FACETADO SC2 14mm LT	296
90109	BL MIRILLA MR1 35/60mm+EMBELLECEDOR MR3 NS	97	90266	BL SOPORTE CERRADO OVAL STA9 30x15mm NI	233	90390	BL EMBELLECEDOR FACETADO SC2 16mm LT	296
90110	BL MIRILLA 14mm 180° MR1 35/60mm NS	96	90269	BL SOPORTE CENTRAL OVAL REG STA10 30x15mm CB	233	90391	BL EMBELLECEDOR FACETADO SC2 18mm LT	296
90112	BL CUADRADILLO EXPANSION CDD3 8x65mm ZN	114	90270	BL SOPORTE CENTRAL OVAL REG STA10 30x15mm LTD	233	90392	BL EMBELLECEDOR FACETADO SC2 12mm NI	296
90113	BL CUADRADILLO RANURADO CDD2 8x100mm ZN	114	90271	BL CIERRE 2 RODILLOS GOMA IM1 BC	248	90393	BL EMBELLECEDOR FACETADO SC2 14mm NI	296
90114	BL CUADRADILLO CDD1 6x90mm ZN	114	90272	BL CIERRE 2 RODILLOS GOMA IM1 ZN	248	90394	BL EMBELLECEDOR FACETADO SC2 16mm NI	296
90115	BL CUADRADILLO CDD1 8x90mm ZN	114	90273	BL CIERRE 2 RODILLOS GOMA IM1 CU	248	90395	BL EMBELLECEDOR FACETADO SC2 18mm NI	296
90116	BL REDUCTOR CUADRADILLO CDD7 8-6mm ZN	115	90274	BL CIERRE BOLA IM6 44mm LT	248	90396	BL SUJETALUNAS LISO SC3 2-6mm LT	297
90119	BL PICAPORTE TUBULAR C/C PCT3 35mm LTD	169	90275	BL CIERRE BOLA IM6 50mm LT	248	90397	BL SUJETALUNAS LISO SC3 5-8mm LT	297
90120	BL PICAPORTE TUBULAR C/C PCT3 35mm NS	169	90276	BL CIERRE BOLA IM6 70mm LT	248	90398	BL SUJETALUNAS LISO SC3 2-6mm NI	297
90121	BL PICAPORTE TUBULAR C/C PCT3 45mm LTD	169	90277	BL CIERRE TOCA-TOCA IM4 35x28mm BL	249	90399	BL SUJETALUNAS LISO SC3 5-8mm NI	297
90122	BL PICAPORTE TUBULAR C/C PCT3 45mm NS	169	90278	BL CIERRE TOCA-TOCA IM4 35x28mm MA	249	90400	BL SUJETALUNAS FACETADO SC3 2-6mm LT	297
90123	BL PICAPORTE TUBULAR C/R PCT3 45mm LTD	169	90281	BL CIERRE MAGNETICO IM2 42mm BL	248	90401	BL SUJETALUNAS FACETADO SC3 5-8mm LT	297
90124	BL PICAPORTE TUBULAR C/R PCT3 45mm NS	169	90282	BL CIERRE MAGNETICO IM2 56mm BL	248	90402	BL SUJETALUNAS FACETADO SC3 2-6mm NI	297
90125	BL TOPE PUERTA LUX TALADRO TP1 OR	125	90283	BL CIERRE MAGNETICO IM2 42mm MA	248	90403	BL SUJETALUNAS FACETADO SC3 5-8mm NI	297
90126	BL TOPE PUERTA LUX TALADRO TP1 OM	125	90284	BL CIERRE MAGNETICO IM2 56mm MA	248	90404	BL SOPORTE CILINDRICO SC4 5-6mm OR	298
90127	BL TOPE PUERTA LUX TALADRO TP1 CB	125	90285	BL CIERRE MAGNETICO C/MUELLE IM3 BL	249	90405	BL SOPORTE CILINDRICO SC4 5-6mm CB	298
90128	BL TOPE PUERTA LUX TALADRO TP1 NS	125	90286	BL CIERRE MAGNETICO C/MUELLE IM3 NE	249	90406	BL SOPORTE CILINDRICO SC4 5-6mm CM	298
90129	BL TOPE PUERTA LUX TALADRO TP1 BL	125	90289	BL CIERRE CAJA CANDADO CC1 75x23mm ZN	290	90407	BL SOPORTE CILINDRICO SC4 5-6mm BL	298
90133	BL TOPE PUERTA SETA TP3 20mm LP	126	90290	BL CIERRE CAJA CC3 53x23mm ZN	291	90410	BL SOPORTE CILINDRICO SC4 8-10mm CB	298
90135	BL TOPE PUERTA SETA TP3 20mm NS	126	90291	BL CIERRE CAJA CC1 75x23mm ZN	290	90411	BL SOPORTE CILINDRICO SC4 8-10mm CM	298
90138	BL TOPE PUERTA SETA PARQUET TP5 20mm IN	126	90292	BL ALDABA CLASICA DCHA ADB1 40mm LTD	131	90419	BL SOPORTE MEDIA LUNA SC6 5-6mm OR	298
90140	BL TOPE PUERTA SETA TP3 20mm IN	126	90293	BL ALDABA CLASICA IZDA ADB1 40mm LTD	131	90420	BL SOPORTE MEDIA LUNA SC6 5-6mm CB	298
90144	BL RETENEDOR PUERTA SUELO RT4 LTD	127	90294	BL ALDABA CLASICA DCHA ADB1 60mm LTD	131	90421	BL SOPORTE MEDIA LUNA SC6 5-6mm CM	298
90145	BL RETENEDOR PUERTA SUELO RT4 CB	127	90295	BL ALDABA CLASICA IZDA ADB1 60mm LTD	131	90422	BL SOPORTE MEDIA LUNA SC6 5-6 mm BL	298
90146	BL RETENEDOR PUERTA PARED RT5 LTD	127	90296	BL ALDABA CLASICA DCHA ADB1 80mm LTD	131	90428	BL SOPORTE MEDIA LUNA SC6 8-10mm OR	298
90147	BL RETENEDOR PUERTA PARED RT5 CB	127	90297	BL ALDABA CLASICA IZDA ADB1 80mm LTD	131	90429	BL SOPORTE MEDIA LUNA SC6 8-10mm CB	298
90151	BL TOPE PUERTA LUX ADHESIVO TP2 NS	125	90298	BL ALDABA CLASICA DCHA ADB1 40mm NI	131	90430	BL SOPORTE MEDIA LUNA SC6 8-10mm CM	298
90157	BL RETENEDOR PIE PEQ RT3 130x25 BL	128	90299	BL ALDABA CLASICA IZDA ADB1 40mm NI	131	90431	BL SOPORTE MEDIA LUNA SC6 8-10mm BL	298
90158	BL RETENEDOR PIE PEQ RT3 130x25 NE	128	90300	BL ALDABA CLASICA DCHA ADB1 60mm NI	131	90433	BL ANGULO REFUERZO AN1 20x20x19mm BC	308
90159	BL RETENEDOR PIE PEQ RT3 130x25 OR	128	90301	BL ALDABA CLASICA IZDA ADB1 60mm NI	131	90434	BL ANGULO REFUERZO AN1 30x30x19mm BC	308
90160	BL RETENEDOR PIE PEQ RT3 130x25 PL	128	90302	BL ALDABA CLASICA DCHA ADB1 80mm NI	131	90435	BL ANGULO REFUERZO AN1 40x40x19mm BC	308
90161	BL PASADOR ALUMINIO D8 P55 50mm OR	76	90303	BL ALDABA CLASICA IZDA ADB1 80mm NI	131	90436	BL ANGULO REFUERZO AN1 50x50x19mm BC	308
90162	BL PASADOR ALUMINIO D8 P55 100mm OR	76	90304	BL CIERRE VENTANA P/BAJO CV1 62x44mm LT	129	90437	BL ANGULO REFUERZO AN1 60x60x19mm BC	308
90163	BL PASADOR ALUMINIO D8 P55 50mm BL	76	90305	BL BISAGRA ESTUCHE BS22 13x15mm LP	189	90438	BL ANGULO REFUERZO AN1 80x80x19mm BC	308
90164	BL PASADOR ALUMINIO D8 P55 100mm BL	76	90306	BL BISAGRA ESTUCHE BS22 13x20mm LP	189	90439	BL ESCUADRA PLANA PLC4 30x30x12mm BC	313
90165	BL PASADOR ALUMINIO D8 P55 50mm PL	76	90307	BL BISAGRA ESTUCHE BS22 13x25mm LP	189	90440	BL ESCUADRA PLANA PLC4 40x40x12mm BC	313
90166	BL PASADOR ALUMINIO D8 P55 100mm PL	76	90308	BL CIERRE ESTUCHE CC11 25mm LP	189	90441	BL ESCUADRA PLANA PLC4 50x50x14mm BC	313
90171	BL PASADOR HIERRO PS1 30mm NI	134	90309	BL BISAGRA BS22+CIERRE ESTUCHE CC11 13x15+25mm LP	189	90442	BL ESCUADRA PLANA PLC4 60x60x15mm BC	313
90172	BL PASADOR HIERRO PS1 35mm NI	134	90310	BL BISAGRA BS22+CIERRE ESTUCHE CC11 13x20+25mm LP	189	90443	BL ESCUADRA PLANA PLC4 80	

NUMÉRICO

Código	Descripción	Pág.	Código	Descripción	Pág.	Código	Descripción	Pág.
90445	BL ANGULO SUPER AN3 30x30mm NE	307	90561	BL EXCENTRICA 15+PERNO R/M EX6 ZN	273	90838	BL COLGADOR ESCUADRA TRIANGULO CG7 ZN	325
90446	BL ANGULO SUPER AN3 50x50mm BL	307	90562	BL EXCENTRICA 15+PERNO M6 EX6 ZN	273	90842	BL PICAPORTE CONDENA C/R PCT1 47mm LTD	168
90447	BL ANGULO SUPER AN3 50x50mm NE	307	90563	BL PERNO R/MADERA EX6 45x34x11mm ZN	273	90843	BL PICAPORTE CONDENA C/R PCT1 47mm NS	168
90448	BL ANGULO SUPER AN3 75x75mm BL	307	90564	BL PERNO M6 EX6 42x34x8mm ZN	273	90844	BL PLACA CARTELA PLC3 30x13mm ZN	313
90449	BL ANGULO SUPER AN3 75x75mm NE	307	90565	BL TAPON EXCENTRICA EX6 17mm BL	273	90845	BL PLACA CARTELA PLC3 40x15mm ZN	313
90450	BL ANGULO C/TAPA PEQ AN20 18x20mm BL	278	90568	BL ENGANCHE EXCENTRICA 20+PERNO R/M EX4 NI	272	90846	BL PLACA CARTELA PLC3 50x17mm ZN	313
90451	BL ANGULO C/TAPA PEQ AN20 18x20mm BE	278	90572	BL PERNO R/MADERA EX4 6x11mm ZN	272	90847	BL PLACA CARTELA PLC3 60x20mm ZN	313
90452	BL ANGULO C/TAPA PEQ AN20 18x20mm MA	278	90573	BL ENGANCHE 20+TORNILLO 14x6mm EX5 BL	269	90848	BL ANILLA TUBO CT3 12mm CB	236
90453	BL ANGULO C/TAPA PEQ AN20 42x20mm BL	278	90579	BL TORNILLO ENGANCHE EX5 14x6mm ZN	269	90849	BL REMATE TUBO BELLOTA CT1 12mm CB	236
90454	BL ANGULO C/TAPA GDE AN20 42x20mm BE	278	90582	BL GRAPA TRASERA RECTANGULAR GRP1 23x17mm ZN	277	90850	BL CONTERA CUAD ALETAS CNT3 20x20mm NE	375
90455	BL ANGULO C/TAPA GDE AN20 42x20mm MA	278	90583	BL DESLIZANTE METALICO DZ3 15mm NI	286	90851	BL CONTERA CUAD ALETAS CNT3 25x25mm NE	375
90456	BL GANCHO X Nº0 CG13 LTD	327	90584	BL DESLIZANTE METALICO DZ3 18mm NI	286	90852	BL CONTERA CUAD ALETAS CNT3 30x30mm NE	375
90457	BL GANCHO X Nº1 CG13 LTD	327	90585	BL DESLIZANTE METALICO DZ3 20mm NI	286	90853	BL CONTERA CUAD ALETAS CNT3 35x35mm NE	375
90458	BL GANCHO X Nº2 CG13 LTD	327	90586	BL DESLIZANTE METALICO DZ3 23mm NI	286	90854	BL CONTERA CUAD ALETAS CNT3 40x40mm NE	375
90459	BL COLGADOR CUADROS Nº0 CG12 LTD	327	90587	BL DESLIZANTE METALICO DZ3 26mm NI	286	90855	BL CONTERA RECT ALETAS CNT4 15x30mm NE	376
90460	BL COLGADOR CUADROS Nº1 CG12 LTD	327	90588	BL DESLIZANTE FIELTRO DZ2 17mm MA	286	90856	BL CONTERA RECT ALETAS CNT4 20x40mm NE	376
90461	BL COLGADOR CUADROS Nº2 CG12 LTD	327	90589	BL DESLIZANTE FIELTRO DZ2 20mm MA	286	90857	BL CONTERA RED REFORZADA CNT1 20mm NE	374
90463	BL ALZAPANO TORNEADO PER19 25mm LT	333	90590	BL DESLIZANTE FIELTRO DZ2 25mm MA	286	90858	BL CONTERA RED REFORZADA CNT1 25mm NE	374
90464	BL GANCHO FORMA S CG23 25mm ZN	328	90591	BL DESLIZANTE FIELTRO DZ3 30mm MA	286	90859	BL CONTERA RED ALETAS CNT2 20mm NE	375
90465	BL GANCHO FORMA S CG23 30mm ZN	328	90592	BL PUNTILLA C/PERDIDA PNT1 0,9x25mm ZN	116	90860	BL CONTERA RED ALETAS CNT2 22mm NE	375
90466	BL GANCHO FORMA S CG23 35mm ZN	328	90593	BL TORNILLO KOMBY TNE3 M6x15mm NI	281	90861	BL CONTERA RED ALETAS CNT2 25mm NE	375
90467	BL GANCHO FORMA S CG23 40mm ZN	328	90594	BL TORNILLO KOMBY TNE3 M6x20mm NI	281	90862	BL CONTERA RED ALETAS CNT2 30mm NE	375
90468	BL GANCHO FORMA S CG23 50mm ZN	328	90595	BL TORNILLO KOMBY TNE3 M6x25mm NI	281	90872	BL COLGADOR CUADROS PEQUEÑO CG16 BL	328
90469	BL GANCHO FORMA S CG23 60mm ZN	328	90596	BL TORNILLO KOMBY TNE3 M6x30mm NI	281	90873	BL COLGADOR CUADROS GRANDE CG17 BL	328
90470	BL GANCHO FORMA S CG23 70mm ZN	328	90597	BL TORNILLO KOMBY TNE3 M6x35mm NI	281	90877	BL TOPE PUERTA LUX ADHESIVO TP7 47mm RB	125
90471	BL GANCHO FORMA S CG23 80mm ZN	328	90598	BL TORNILLO KOMBY TNE3 M6x40mm NI	281	90878	BL TOPE PUERTA LUX ADHESIVO TP7 47mm BL	125
90474	BL PINZA ZOCALO MADERA/ALUMINIO ZCL5 NE	367	90599	BL TORNILLO KOMBY TNE3 M6x50mm NI	281	90879	BL TOPE PUERTA LUX ADHESIVO TP7 47mm SAPELI	125
90479	BL PLACA CIEGA PLP1 80x80mm LP	99	90600	BL TORNILLO KOMBY TNE3 M6x60mm LP	281	90880	BL TOPE PUERTA LUX ADHESIVO TP7 47mm HAYA	125
90480	BL PLACA CIEGA PLP1 80x80mm LS	99	90601	BL BISAGRA COMPAS BCP5 200mm ZN	385	90885	BL COLGADOR CUADROS TELA ENGOMADA CG18 BL	327
90481	BL PLACA CIEGA PLP1 80x80mm NS	99	90602	BL LLAVERO PORTAETIQUETAS PTQ2 BLANCO	413	90900	BL ESCUDO TAPAPOMO REDONDO ES4 60mm LP	116
90482	BL PLACA CIEGA PLP1 100x70mm LP	99	90603	BL LLAVERO PORTAETIQUETAS PTQ2 NEGRO	413	90901	BL ESCUDO TAPAPOMO REDONDO ES4 60mm NS	116
90483	BL PLACA CIEGA PLP1 100x70mm LS	99	90604	BL LLAVERO PORTAETIQUETAS PTQ2 SURTIDO	413	90902	BL ADAPTADOR UNIFICADO CERRADURA CS8 ZN	112
90484	BL PLACA CIEGA PLP1 100x70mm NS	99	90605	BL LLAVERO PORTAETIQUETAS PTQ2 AMARILLO	413	90906	BL TAPON ADH TPN1 13mm BLANCO (20)	260
90485	BL PLACA BOCALLAVE PLP2 80x80mm LP	100	90606	BL LLAVERO PORTAETIQUETAS PTQ2 ROJO	413	90907	BL TAPON ADH TPN1 13mm BL PORO (20)	260
90486	BL PLACA BOCALLAVE PLP2 80x80mm LS	100	90607	BL LLAVERO PORTAETIQUETAS PTQ2 AZUL	413	90908	BL TAPON ADH TPN1 13mm NEGRO (20)	260
90487	BL PLACA BOCALLAVE PLP2 80x80mm NS	100	90608	BL LLAVERO PORTAETIQUETAS PTQ2 NARANJA	413	90909	BL TAPON ADH TPN1 13mm NE PORO (20)	260
90488	BL PLACA BOCALLAVE PLP2 100x70mm LP	100	90609	BL LLAVERO PORTAETIQUETAS PTQ2 VERDE	413	90910	BL TAPON ADH TPN1 13mm GRIS (20)	260
90489	BL PLACA BOCALLAVE PLP2 100x70mm LS	100	90610	BL LLAVERO PORTAETIQUETAS PTQ2 GRIS	413	90911	BL TAPON ADH TPN1 13mm CREMA (20)	260
90490	BL PLACA BOCALLAVE PLP2 100x70mm NS	100	90611	BL LLAVERO ANILLA LLV1 16mm NI	413	90912	BL TAPON ADH TPN1 13mm HAYA (20)	260
90491	BL BISAGRA CAZOLETA RECTA BC1 26mm ZN	193	90612	BL LLAVERO ANILLA LLV1 18mm NI	413	90913	BL TAPON ADH TPN1 13mm ROBLE (20)	260
90492	BL BISAGRA CAZOLETA ACOD BC1 26mm ZN	193	90613	BL LLAVERO ANILLA LLV1 20mm NI	413	90914	BL TAPON ADH TPN1 13mm PINO (20)	260
90493	BL BISAGRA CAZOLETA S-AC BC1 26mm ZN	193	90614	BL LLAVERO ANILLA LLV1 25mm NI	413	90915	BL TAPON ADH TPN1 13mm NOGAL (20)	260
90494	BL BISAGRA CAZOLETA RECTA BC2 35mm ZN	193	90615	BL LLAVERO ANILLA LLV1 30mm NI	413	90916	BL TAPON ADH TPN1 13mm CEREZO (20)	260
90495	BL BISAGRA CAZOLETA ACOD BC2 35mm ZN	193	90616	BL LLAVERO ANILLA LLV1 35mm NI	413	90917	BL TAPON ADH TPN1 13mm MAPLE (20)	260
90496	BL BISAGRA CAZOLETA S-AC BC2 35mm ZN	193	90618	BL TAPON PASACABLES TPC1 60x22mm BE	219	90918	BL TAPON ADH TPN1 13mm SAPELI (20)	260
90497	BL BISAGRA CAZOLETA CLIP RECTA BC3 35mm ZN	193	90619	BL TAPON PASACABLES TPC1 60x22mm MA	219	90919	BL TAPON ADH TPN1 13mm WENGUE (20)	260
90498	BL BISAGRA CAZOLETA CLIP ACOD BC3 35mm ZN	193	90620	BL TAPON PASACABLES TPC1 60x22mm PL	219	90920	BL TAPON ADH TPN1 13mm PLATA (20)	260
90499	BL BISAGRA CAZOLETA CLIP S-AC BC3 35mm ZN	193	90621	BL TAPON PASACABLES TPC1 60x22mm BL	219	90924	BL PERNIO C/R DCHA PN3 100x58mm LS	178
90500	BL TORNILLO ENSAMBLE TNE1 5x50mm NE	279	90622	BL SOPORTE PELICANO SP4 75x65mm BL	300	90925	BL PERNIO C/R IDZA PN3 100x58mm LS	178
90501	BL BISAGRA CAZOLETA PISTON RECTA BC5 35mm ZN	194	90623	BL SOPORTE PELICANO SP4 75x65mm NE	300	90928	BL PERNIO C/R DCHA PN3 100x58mm CU	178
90502	BL BISAGRA CAZOLETA PISTON ACOD BC5 35mm ZN	194	90624	BL SOPORTE PELICANO SP4 75x65mm OR	300	90929	BL PERNIO C/R IDZA PN3 100x58mm CU	178
90503	BL BISAGRA CAZOLETA PISTON S-AC BC5 35mm ZN	194	90625	BL SOPORTE PELICANO SP4 75x65mm CB	300	90930	BL PERNIO C/R DCHA PN3 100x58mm NE	178
90504	BL BISAGRA CAZOLETA SOBREPONER BC10 ZN	196	90626	BL SOPORTE PELICANO SP4 75x65mm CM	300	90931	BL PERNIO C/R IDZA PN3 100x58mm NE	178
90505	BL LAGRIMA ADHESIVA LGM1 7x1,5mm TR	258	90632	BL LAGRIMA EMBUTIR BIMATERIA LGM8 8,8x2,5mm TR	259	90932	BL PERNIO S/R DCHA PN4 100x58mm LS	178
90506	BL LAGRIMA ADHESIVA LGM1 10x3mm TR	258	90635	BL PORTAESTANTE CRISTAL PE9 5mm NI	267	90933	BL PERNIO S/R IDZA PN4 100x58mm LS	178
90507	BL LAGRIMA ADHESIVA LGM2 13x4mm TR	258	90636	BL PISTON GAS ELEVEABLE BCP1 8kg AL	383	90934	BL PERNIO S/R DCHA PN4 100x58mm NS	178
90510	BL ASA ABATIBLE LISA TRM12 100x27mm NE	205	90637	BL PISTON GAS ELEVEABLE BCP1 12kg AL	383	90935	BL PERNIO S/R IDZA PN4 100x58mm NS	178
90511	BL ASA ABATIBLE LISA TRM12 125x27mm NE	205	90638	BL SOPORTE CERRADO OVAL REG STA110 30x15mm AL	233	90936	BL BISAGRA SOLAPADA C/REM BS24 40mm LTD	192
90512	BL ASA ABATIBLE LISA TRM12 100x27mm ZN	205	90639	BL SOPORTE CERRADO OVAL REG STA111 30x15mm CB	233	90937	BL BISAGRA SOLAPADA C/REM BS24 40mm CB	192
90513	BL ASA ABATIBLE LISA TRM12 125x27mm ZN	205	90640	BL SOPORTE CERRADO OVAL REG STA111 30x15mm LTD	233	90938	BL BISAGRA SOLAPADA C/REM BS24 40mm LE	192
90514	BL ASA ABATIBLE LISA TRM12 100x27mm BC	205	90641	BL SOPORTE CERRADO OVAL REG STA111 30x15mm LTD	233	90939	BL BISAGRA SOLAPADA C/REM BS24 53mm LTD	192
90515	BL ASA ABATIBLE LISA TRM12 125x27mm BC	205	90642	BL TORNILLO MULTICORTE TRN7 M4x45mm ZN	210	90940	BL BISAGRA SOLAPADA C/REM BS24 53mm CB	192
90516	BL PLACA RECTA UNION PCL1 40x16mm BC	312	90643	BL SOPORTE PASAMANOS TORNILLOS PMN1 LP	139	90941	BL BISAGRA SOLAPADA C/REM BS24 53mm LE	192
90517	BL PLACA RECTA UNION PCL1 60x16mm BC	312	90644	BL SOPORTE PASAMANOS TORNILLOS PMN1 NE	139	90942	BL BISAGRA SOLAPADA S/REM BS25 40mm LTD	192
90518	BL PLACA RECTA UNION PCL1 80x19mm BC	312	90645	BL SOPORTE PASAMANOS TORNILLOS PMN1 NS	139	90943	BL BISAGRA SOLAPADA S/REM BS25 40mm CB	192
90519	BL PLACA RECTA UNION PCL1 100x19mm BC	312	90646	BL SOPORTE PASAMANOS DOWELL PMN2 LP	139	90944	BL BISAGRA SOLAPADA S/REM BS25 40mm LE	192
90520	BL PLACA RECTA UNION PCL2 40x15mm ZN	312	90648	BL SOPORTE PASAMANOS DOWELL PMN2 NE	139	90945	BL BISAGRA SOLAPADA S/REM BS25 53mm LTD	192
90521	BL PLACA RECTA UNION PCL2 60x15mm ZN	312	90649	BL SOPORTE PASAMANOS DOWELL PMN2 NS	139	90946	BL BISAGRA SOLAPADA S/REM BS25 53mm CB	192
90522	BL PLACA RECTA UNION PCL2 80x15mm ZN	312	90650	BL LLAMADOR INGLÉS LLM1 200x90mm LP	92	90947	BL BISAGRA SOLAPADA S/REM BS25 53mm LE	192
90523	BL PLACA RECTA UNION PCL2 100x15mm ZN	312	90652	BL LLAMADOR INGLÉS LLM1 200x90mm NS	92	90948	BL PERNIO S/R DCHA PN7 100x58mm IN	177
90524	BL COLGADOR MUEBLE SENCILLO CG9 ZN	325	90654	BL LLAMADOR INGLÉS LLM1 200x90mm NE	92	90949	BL PERNIO S/R IDZA PN7 100x58mm IN	177
90525	BL COLGADOR MUEBLE DOBLE CG9 ZN	325	90655	BL ANGULO REFUERZO AN1 100x100x19mm BC	308	91000	ET ANGULO REFUERZO AN1 20x20x19mm BC	308
90526	BL PLACA COLGADOR GALERIA CG11 40x18mm ZN	326	90656	BL ESCUADRA PLANA PLC4 100x100x17mm BC	313	91001	ET ANGULO REFUERZO AN1 30x30x19mm BC	308
90527	BL PLACA COLGADOR GALERIA CG11 50x18mm ZN	326	90657	BL ESCUADRA PLANA PLC4 120x120mm BC	313	91002	ET ANGULO REFUERZO AN1 40x40x19mm BC	308
90528	BL PLACA COLGADOR GALERIA CG11 60x18mm ZN	326	90658	BL ANGULO SUPER AN3 100x100mm BL	307	91003	ET ANGULO REFUERZO AN1 50x50x19mm BC	308
90529	BL PLACA COLGADOR GALERIA CG11 70x20mm ZN	326	90659	BL ANGULO SUPER AN3 100x100mm NE	307	91004	ET ANGULO REFUERZO AN1 60x60x19mm BC	308
90530	BL PLACA COLGADOR GALERIA CG11 80x20mm ZN	326	90663	BL CUADRADILLO EXPANSION CDD3 8x55mm ZN	114	91005	ET ANGULO REFUERZO AN1 80x80x19mm BC	308
90531	BL EXPULSOR C/BASE AMORTIGUADOR IM8 13mm GR	252	90664	BL TORNILLO PASANTE MULTICORTE TRN2 M4x75mm LTD	117	91006	ET ANGULO REFUERZO AN1 100x100x19mm BC	308
90532	BL EXPULSOR C/BASE AMORTIGUADOR IM8 40mm GR	252	90665	BL TORNILLO TIRADOR TRN8 M4x8mm ZN	210	91007	ET ESCUADRA PLANA PLC4 30x30x12mm BC	313
90533	BL EXPULSOR EMBUTIR AMORTIGUADOR IM10 16mm GR	253	90666	BL TORNILLO TIRADOR TRN8 M4x14mm ZN	210	91008	ET ESCUADRA PLANA PLC4 40x40x12mm BC	313
90534	BL EXPULSOR EMBUTIR AMORTIGUADOR IM10 37mm GR	253	90667	BL TORNILLO TIRADOR TRN8 M4x20mm ZN	210	91009	ET ESCUADRA PLANA PLC4 50x50x14mm BC	313
90535	BL EXPULSOR C/BASE IMAN IM9 13mm GR	252	90668	BL TORNILLO TIRADOR TRN8 M4x22mm ZN	210	91010	ET ESCUADRA PLANA PLC4 60x60x15mm BC	313
90536	BL EXPULSOR C/BASE IMAN IM9 40mm GR	252	90669	BL TORNILLO TIRADOR TRN8 M4x25mm ZN	210	91011	ET ESCUADRA PLANA PLC4 80x80x17mm BC	313
90537	BL EXPULSOR EMBUTIR IMAN IM11 16mm GR	253	90670	BL TORNILLO TIRADOR TRN8 M4x28mm ZN	210	91012	ET ESCUADRA PLANA PLC4 100x100x17mm BC	313
90538	BL EXPULSOR EMBUTIR IMAN IM11 37mm GR	253	90671	BL TORNILLO TIRADOR TRN8 M4x30mm ZN	210	91013	ET ESCUADRA PLANA PLC4 120x120x17mm BC	313
90539	BL EXPULSOR EMBUTIR IMAN REG IM12 17mm GR	253	90673	BL TORNILLO TIRADOR TRN8 M4x35mm ZN	210	91014	ET PLACA RECTA UNION PCL2 40x15mm ZN	312
90540	BL EXPULSOR EMBUTIR AMORTIGUADOR REG IM38 17mm GR	253	90674	BL TORNILLO TIRADOR TRN8 M4x40mm ZN	210	91015	ET PLACA RECTA UNION PCL2 60x15mm ZN	312
90543	BL AMORTIGUADOR EMBUTIR IM13 BL	250	90721	BL OVALILLO PERNIO OV1 LTD	179	91016	ET PLACA RECTA UNION PCL2 80x15mm ZN	312
90549	BL NIVELADOR POMO NV8 M6x27mm NE	370	90722	BL OVALILLO PERNIO OV1 NE	179	91017	ET PLACA RECTA UNION PCL2 100x15mm ZN	312
90550	BL NIVELADOR POMO NV8 M6x38mm NE	370	90723	BL PORTAESTANTE SAFETY PE6 3mm TR	266	91018	ET PLACA RECTA UNION PCL2 120x15mm ZN	312
90551	BL NIVELADOR POMO NV8 M10x40mm NE	370	90724	BL PORTAESTANTE SAFETY LARGO PE7 5mm TR	266	91019	ET PLACA RECTA UNION PCL1 40x16mm BC	312
90552	BL TUERCA PUJA EMBUTIR TRC2 M4 ZN	276	90725	BL PORTAESTANTE ARANDELA PE3 4-5x16mm ZN	265	91020	ET PLACA RECTA UNION PCL1 60x16mm BC	312
90553	BL TUERCA PUJA EMBUTIR TRC2 M6 ZN	276	90733	BL TAPON ADH P/BISAGRA TPN4 BLANCO	262	91021	ET PLACA RECTA UNION PCL1 80x16mm BC	312
90554	BL TUERCA PUJA EMBUTIR TRC2 M8 ZN	276	90734	BL TAPON ADH P/BISAGRA TPN4 GRIS	262	91022	ET PLACA RECTA UNION PCL1 100x19mm BC	312
90555	BL TUERCA PUJA EMBUTIR TRC2 M10 ZN	276	90735	BL TAPON ADH P/BISAGRA TPN4 ROBLE	262	91023	ET PLACA RECTA UNION PCL1 120x19mm BC	312
90556	BL TUERCA EMBUTIR TRC3 M6x12x12mm ZN	275	90736	BL TAPON ADH P/BISAGRA TPN4 HAYA	262	91024	ET ANGULO SUPER AN3 30x30mm BL	307
90557	BL TUERCA EMBUTIR TRC3 M6x12x14mm ZN	275	90743	BL TORNILLO ENSAMBLE TNE1 7x50mm NE	279			

NUMÉRICO

Código	Descripción	Pág.	Código	Descripción	Pág.	Código	Descripción	Pág.
91029	ET ANGULO SUPER AN3 50x50mm ZN	307	91192	BL ALDABILLA RETENIDA ADB3 3,5x60mm ZN	132	91299	BL PORTACANADADO CC10 100mm NE	135
91030	ET ANGULO SUPER AN3 75x75mm ZN	307	91193	BL ALDABILLA RETENIDA ADB3 4x80mm ZN	132	91300	BL PORTACANADADO CC10 75mm NE	135
91031	ET ANGULO SUPER AN3 100x100mm ZN	307	91194	BL ALDABILLA RETENIDA ADB3 4x100mm ZN	132	91301	BL PORTACANADADO CC10 120mm NE	135
91082	ET ANGULO REFUERZO AN2 20x20x15mm ZN	309	91195	BL TACHUELA PLANA TCH1 8x14mm LTD	415	91302	BL PERNIO TORNEADO 692 10x58mm PU	180
91083	ET ANGULO REFUERZO AN2 30x30x15mm ZN	309	91196	BL TACHUELA PLANA TCH1 8x14mm CU	415	91303	BL PERNIO TORNEADO 692 12x70mm PU	180
91084	ET ANGULO REFUERZO AN2 40x40x15mm ZN	309	91197	BL TACHUELA PLANA TCH1 8x14mm PV	415	91304	BL PERNIO TORNEADO 692 14x80mm PU	180
91085	ET ANGULO REFUERZO AN2 50x50x15mm ZN	309	91198	BL TACHUELA PLANA TCH1 10x15mm LTD	415	91305	BL PERNIO TORNEADO 692 16x100mm PU	180
91086	ET ANGULO REFUERZO AN2 60x60x15mm ZN	309	91199	BL TACHUELA PLANA TCH1 10x15mm CU	415	91310	BL PERNIO RODAMIENTO AXIAL 694 16x100mm PU	180
91087	ET ANGULO REFUERZO AN2 80x80x15mm ZN	309	91200	BL TACHUELA PLANA TCH1 10x15mm PV	415	91311	BL PERNIO PERFIL GOTA 695 10x60mm PU	180
91088	ET ANGULO REFUERZO AN2 100x100x15mm ZN	309	91201	BL TACHUELA PLANA TCH1 10x15mm BL	415	91312	BL PERNIO PERFIL GOTA 695 14x80mm PU	180
91089	ET ESCUADRA PLANA PLC5 40x40x12mm ZN	314	91202	BL TACHUELA PLANA TCH1 10x15mm NE	415	91313	BL PERNIO PERFIL GOTA 695 16x100mm PU	180
91090	ET ESCUADRA PLANA PLC5 50x50x12mm ZN	314	91207	BL TACHUELA PLANA TCH1 12x16mm LTD	415	91314	BL PERNIO PALA 696 10x60mm PU	181
91091	ET ESCUADRA PLANA PLC5 60x60x12mm ZN	314	91208	BL TACHUELA PLANA TCH1 12x16mm CU	415	91315	BL PERNIO PALA 696 14x80mm PU	181
91092	ET ESCUADRA PLANA PLC5 80x80x18mm ZN	314	91209	BL TACHUELA PLANA TCH1 12x16mm PV	415	91316	BL PERNIO PALA 696 16x100mm PU	181
91093	ET ESCUADRA PLANA PLC5 100x100x18mm ZN	314	91210	BL CIERRE MAGNETICO REG IM5 30x30mm BL	249	91317	BL PERNIO PALA LARGA 699 14x80mm PU	181
91094	ET ESCUADRA PLANA PLC5 120x120x18mm ZN	314	91211	BL CIERRE MAGNETICO REG IM5 30x30mm MA	249	91318	BL PERNIO PALA LARGA 699 16x100mm PU	181
91095	BL CERRADURA MUEBLE CM1 26mm CB	240	91212	BL CIERRE MAGNETICO REG IM5 30x30mm NE	249	91320	BL NIVELADOR TOP NV10 60x30mm GR	368
91096	BL CERRADURA MUEBLE CM1 32mm CB	240	91215	BL TAPON ADH TPN3 25mm BLANCO (12)	261	91322	BL CERRADURA MUEBLE GANCHO CM2 22mm CB	240
91097	BL CERRADERO ESCUADRA CM11 CB	241	91216	BL TAPON ADH TPN3 25mm NEGRO (12)	261	91323	BL CERRADURA VITRINA 1P CM6 32x25mm CB	244
91098	BL CERRADURA PULSAR CM3 26-35mm CB	243	91217	BL TAPON ADH TPN3 25mm GRIS (12)	261	91324	BL CERRADURA VITRINA 2P CM7 48x35mm CB	244
91099	BL CERRADURA VITRINA CM8 120mm CB	244	91218	BL TAPON ADH TPN3 25mm HAYA (12)	261	91325	BL PIVOTE SUJETA CAMPANA PVT1 ZN	350
91100	BL CERRADURA BUZON RECTA CM4 20mm CB	245	91219	BL TAPON ADH TPN3 25mm ROBLE (12)	261	91326	BL GRAPA TRASERA REDONDA GRP2 15mm ZN	277
91101	BL CERRADURA BUZON RECTA CM4 30mm CB	245	91220	BL TAPON ADH TPN3 25mm CEREZO (12)	261	91327	BL RODAMIENTO INASA 151 RD12 ZN	82
91102	BL CERRADURA BUZON CURVA CM5 20mm CB	245	91221	BL TAPON ADH TPN3 25mm WENGUE (12)	261	91328	BL RODAMIENTO 157 RD13 BC	82
91103	BL ESQUINA COPETE CLASSIC CPT1 AL	344	91222	BL TAPON PLASTICO ENVOLVENTE TPN6 BL	262	91329	BL RODAMIENTO 158 RD14 BC	83
91104	BL ESQUINA COPETE CLASSIC CPT1 BL	344	91223	BL TAPON PLASTICO ENVOLVENTE TPN6 MA	262	91330	BL RODAMIENTO 158/5 RD15 BC	83
91105	BL ESQUINA COPETE CLASSIC CPT1 NE	344	91224	BL TAPON PLASTICO ENVOLVENTE TPN6 GR	262	91331	BL RODAMIENTO INASA 162 RD12 ZN	83
91106	BL ESQUINA COPETE ROUND CPT2 AL	345	91225	BL CHINCHETA TCH2 SURTIDO	415	91332	BL RODAMIENTO CLIMALIT 177 RD17 ZN	83
91107	BL ESQUINA COPETE ROUND CPT2 BL	345	91226	BL CHINCHETA TCH2 NI	415	91333	BL RODAMIENTO INASA 163 RD9 BL	80
91109	BL RINCON COPETE CLASSIC CPT1 AL	344	91228	BL ESPIRAL VISILLO FORRADO EV1 3mts BL	226	91334	BL RODAMIENTO 172 RD7 BL	80
91110	BL RINCON COPETE CLASSIC CPT1 BL	344	91229	BL SOPORTE LATERAL OVAL STA6 BL	232	91335	BL RODAMIENTO INASA CLL RD10 BL	80
91111	BL RINCON COPETE CLASSIC CPT1 NE	344	91230	BL EMPALME TUBO ARMARIO TA5 12mm ZN	228	91336	BL RODAMIENTO CLL104 RD18 BC	84
91112	BL RINCON COPETE ROUND CPT2 AL	345	91231	BL SOPORTE LATERAL STOR STA14 14mm BC	231	91337	BL RODAMIENTO MAMPARA RD1 20mm NE	87
91113	BL RINCON COPETE ROUND CPT2 BL	345	91232	BL SOPORTE LATERAL STOR STA14 18mm BC	231	91338	BL RODAMIENTO MAMPARA RD1 26mm NE	87
91115	BL TAPA COPETE CLASSIC I+D CPT1 AL	344	91233	BL SOPORTE LATERAL STOR STA14 22mm BC	231	91339	BL RODAMIENTO CO-22 RD8 BL	80
91116	BL TAPA COPETE CLASSIC I+D CPT1 BL	344	91234	BL REMATE TUBO BELLOTA CT1 12mm BL	236	91340	BL BISAGRA 5005 1" BS27 25x20mm ZN	186
91117	BL TAPA COPETE CLASSIC I+D CPT1 NE	344	91235	BL ANILLA TUBO CT3 12mm BL	236	91341	BL BISAGRA 5005 1" 1/2 BS27 37x26mm ZN	186
91118	BL TAPA COPETE ROUND CPT2 AL	345	91236	BL ANILLA TUBO CT3 16mm BL	236	91342	BL BISAGRA 5005 2" BS27 50x30mm ZN	186
91119	BL TAPA COPETE ROUND CPT2 BL	345	91237	BL ANILLA TUBO CT3 16mm CU	236	91343	BL BISAGRA 5005 2" 1/2 BS27 63x32mm ZN	186
91121	BL COLGADOR MUEBLE EMBUTIR CG10 ZN	325	91238	BL REMATE TUBO PIÑA CT2 12mm CB	236	91344	BL BISAGRA 5005 3" BS27 75x42mm ZN	186
91122	BL ANGULO REFUERZO AN2 20x20x15mm ZN	309	91239	BL REMATE TUBO PIÑA CT2 12mm BL	236	91345	BL BISAGRA RAMAL 2" BS28 22x50mm ZN	187
91123	BL ANGULO REFUERZO AN2 30x30x15mm ZN	309	91240	BL REMATE TUBO PIÑA CT2 16mm CB	236	91346	BL BISAGRA RAMAL 2" 1/2 BS28 22x63mm ZN	187
91124	BL ANGULO REFUERZO AN2 40x40x15mm ZN	309	91241	BL REMATE TUBO PIÑA CT2 16mm BL	236	91347	BL BISAGRA RAMAL 3" BS28 25x75mm ZN	187
91125	BL ANGULO REFUERZO AN2 50x50x15mm ZN	309	91242	BL PLACA COLGADOR EXTINTOR CG14 6kgs ZN	326	91348	BL BISAGRA RAMAL 4" BS28 25x100mm ZN	187
91126	BL ANGULO REFUERZO AN2 60x60x15mm ZN	309	91243	BL HEMBRILLA C/T SOLDADA HM1 M3x30mm ZN	332	91349	BL BISAGRA 814 3/4" BS29 22x64mm ZN	187
91127	BL ANGULO REFUERZO AN2 80x80x15mm ZN	309	91244	BL HEMBRILLA C/T SOLDADA HM1 M4x30mm ZN	332	91350	BL BISAGRA 814 1" BS29 25x76mm ZN	187
91128	BL ESCUADRA PLANA PLC5 40x40x12mm ZN	314	91245	BL HEMBRILLA C/T SOLDADA HM1 M5x40mm ZN	332	91351	BL BISAGRA 814 1" 1/4 BS29 31x84mm ZN	187
91129	BL ESCUADRA PLANA PLC5 50x50x12mm ZN	314	91246	BL HEMBRILLA C/T SOLDADA HM1 M6x50mm ZN	332	91352	BL BISAGRA 814 1" 1/2 BS29 37x90mm ZN	187
91130	BL ESCUADRA PLANA PLC5 60x60x12mm ZN	314	91247	BL HEMBRILLA C/T SOLDADA HM1 M8x60mm ZN	332	91353	BL BISAGRA 814 1" 3/4 BS29 43x102mm ZN	187
91131	BL ESCUADRA PLANA PLC5 80x80x18mm ZN	314	91248	BL HEMBRILLA C/T ABIERTA HM2 M3x30mm ZN	332	91354	BL BISAGRA 816 1" BS30 22x50mm ZN	188
91132	BL PLACA CUADRA PLCA6 45x45mm ZN	311	91249	BL HEMBRILLA C/T ABIERTA HM2 M4x30mm ZN	332	91355	BL BISAGRA 816 1" 1/4 BS30 31x57mm ZN	188
91133	BL PLACA RECTANGULAR PLCA7 70x35 ZN	311	91250	BL HEMBRILLA C/T ABIERTA HM2 M5x35mm ZN	332	91356	BL BISAGRA 816 1" 1/2 BS31 37x70mm ZN	188
91134	BL ANGULO REFUERZO AN5 20x20x40mm ZN	310	91251	BL HEMBRILLA C/T ABIERTA HM2 M6x50mm ZN	332	91357	BL BISAGRA 816 1" 3/4 BS30 43x78mm ZN	188
91135	BL ANGULO REFUERZO AN6 20x20x50mm ZN	310	91252	BL HEMBRILLA C/T ABIERTA HM2 M6x60mm ZN	332	91358	BL BISAGRA 816 2" BS30 50x95mm ZN	188
91136	BL ANGULO REFUERZO AN7 21x21x67mm ZN	310	91253	BL CILINDRO SEGURIDAD CS2 L15 30x30mm LT	106	91359	BL BISAGRA 816 2" 1/4 BS30 56x103mm ZN	188
91137	BL ANGULO REFUERZO AN8 21x21x86mm ZN	310	91254	BL CILINDRO SEGURIDAD CS2 L15 30x30mm NI	106	91360	BL BISAGRA 840 3" BS31 75x49mm ZN	188
91138	BL ANGULO REFUERZO AN9 40x40x90mm ZN	311	91255	BL CILINDRO SEGURIDAD CS2 L15 35x35mm LT	106	91361	BL BISAGRA 840 3" 1/2 BS31 87x55mm ZN	188
91139	BL ANGULO FIJACION AN10 38x28x23 ZN	309	91256	BL CILINDRO SEGURIDAD CS2 L15 35x35mm NI	106	91362	BL BISAGRA 840 4" BS31 100x70mm ZN	188
91140	BL ANGULO REFUERZO AN1 20x20x19mm BL	308	91257	BL CILINDRO SEGURIDAD CS2 L15 30x40mm LT	106	91363	BL BISAGRA BIOMBO BS20 50x20x0,9mm LTD	192
91141	BL ANGULO REFUERZO AN1 30x30x19mm BL	308	91258	BL CILINDRO SEGURIDAD CS2 L15 30x40mm NI	106	91364	BL BISAGRA BIOMBO BS20 60x25x1,2mm LTD	192
91142	BL ANGULO REFUERZO AN1 40x40x19mm BL	308	91259	BL CILINDRO SEGURIDAD CS2 L15 40x40mm LT	106	91365	BL BISAGRA BIOMBO BS20 60x30x1,5mm LTD	192
91143	BL ANGULO REFUERZO AN1 50x50x19mm BL	308	91260	BL CILINDRO SEGURIDAD CS2 L15 40x40mm NI	106	91366	BL BISAGRA MOSTRADOR BS19 32x80mm LTD	184
91144	BL ANGULO REFUERZO AN1 60x60x19mm BL	308	91261	BL CILINDRO SEGURIDAD CS2 L15 30x50mm LT	106	91367	BL BISAGRA MOSTRADOR BS19 32x80mm ZN	184
91146	BL RUEDA EMBUTIR GIRATORIA RUM7 40mm NE	379	91262	BL CILINDRO SEGURIDAD CS2 L15 30x50mm NI	106	91368	BL BISAGRA OCULTA BS1 10mm LS	183
91147	BL RUEDA EMBUTIR FIJA RUM8 40mm NE	379	91263	BL CILINDRO SEGURIDAD CS2 L15 40x50mm LT	106	91369	BL BISAGRA OCULTA BS1 12mm LS	183
91148	BL RUEDA MUEBLE FIJA RUM9 15mm ZN	379	91264	BL CILINDRO SEGURIDAD CS2 L15 40x50mm NI	106	91370	BL BISAGRA OCULTA BS1 14mm LS	183
91149	BL RUEDA MUEBLE FIJA RUM9 25mm ZN	379	91265	BL CILINDRO SEGURIDAD CS2 L13 30x40mm NI	107	91378	BL TUERCA EMBUTIR TRG3 M10x15x17mm BC	275
91150	BL RUEDA MUEBLE FIJA RUM9 30mm ZN	379	91266	BL CILINDRO SEGURIDAD CS2 L13 40x10mm NI	107	91379	KIT TERMINAL ESPIRAL VISILLO EV3 NI	227
91151	BL COMPAS ELEVABLE REGULABLE BCP6 NI	384	91267	BL CILINDRO SEGURIDAD CS2 L13 30x30mm NI	107	91380	KIT TERMINAL ESPIRAL VISILLO EV3 NI	227
91152	BL POLEA TENDER TORNILLO POL4 40mm ZN	412	91268	BL CILINDRO SEGURIDAD CS2 L13 35x35mm NI	107	91381	BL BISAGRA 5005 1" BS27 25x20mm LTD	186
91153	BL POLEA TENDER TORNILLO POL3 40mm ZN	412	91269	BL CILINDRO SEGURIDAD CS2 L13 30x40mm NI	107	91382	BL BISAGRA 5005 1" 1/2 BS27 37x26mm LTD	186
91154	BL POLEA TENDER C/TUERCA POL2 40mm ZN	412	91270	BL CILINDRO SEGURIDAD CS2 L13 40x40mm NI	107	91383	BL BISAGRA 5005 2" BS27 50x30mm LTD	186
91155	BL POLEA TENDER C/TUERCA POL2 60mm ZN	412	91271	BL CILINDRO SERRETA CS3 L15 30x30mm LT	109	91384	BL BISAGRA 5005 2" 1/2 BS27 63x32mm LTD	186
91156	BL POLEA TENDER C/TUERCA POL1 40mm ZN	412	91272	BL CILINDRO SERRETA CS3 L15 30x30mm NI	109	91385	BL BISAGRA 5005 3" BS27 75x42mm LTD	186
91157	BL POLEA TENDER C/TUERCA POL1 60mm ZN	412	91273	BL CILINDRO SERRETA CS3 L15 35x35mm LT	109	91388	BL CORCHETE CORTINA CT5 BL	237
91159	BL GARRA PRECERCO PRC3 85x17,5mm ZN	118	91274	BL CILINDRO SERRETA CS3 L15 35x35mm NI	109	91389	BL FIELTRO ADHESIVO DZ7 16mm MA	288
91168	BL NIVELADOR REGULABLE NV12 50x19mm NE	368	91275	BL CILINDRO SERRETA CS3 L15 30x40mm LT	109	91390	BL FIELTRO ADHESIVO DZ7 22mm MA	288
91169	BL NIVELADOR REGULABLE NV13 50x28mm NE	368	91276	BL CILINDRO SERRETA CS3 L15 30x40mm NI	109	91391	BL FIELTRO ADHESIVO DZ7 26mm MA	288
91170	BL DEDAL EMBUTIR DDL1 8mm LT	138	91277	BL CILINDRO SERRETA CS3 L15 40x40mm LT	109	91392	BL FIELTRO ADHESIVO DZ7 34mm MA	288
91171	BL DEDAL EMBUTIR DDL1 10mm LT	138	91278	BL CILINDRO SERRETA CS3 L15 40x40mm NI	109	91393	BL FIELTRO ADHESIVO DZ8 17x17mm MA	289
91172	BL DEDAL EMBUTIR DDL1 12mm LT	138	91279	BL CILINDRO SERRETA CS3 L15 30x50mm LT	109	91394	BL FIELTRO ADHESIVO DZ8 22x22mm MA	289
91173	BL DEDAL EMBUTIR DDL1 14mm LT	138	91280	BL CILINDRO SERRETA CS3 L15 30x50mm NI	109	91395	BL FIELTRO ADHESIVO DZ7 20mm MA	288
91174	BL DEDAL EMBUTIR DDL1 20mm LT	138	91281	BL CILINDRO SERRETA CS3 L15 40x50mm LT	109	91396	BL FIELTRO ADHESIVO DZ7 16mm BL	288
91175	BL DEDAL EMBUTIR DDL1 22mm LT	138	91282	BL CILINDRO SERRETA CS3 L15 40x50mm NI	109	91397	BL FIELTRO ADHESIVO DZ7 22mm BL	288
91176	BL DEDAL EMBUTIR DDL1 8mm NI	138	91283	BL CILINDRO SERRETA CS3 L13 30x10mm NI	110	91398	BL FIELTRO ADHESIVO DZ7 26mm BL	288
91177	BL DEDAL EMBUTIR DDL1 10mm NI	138	91284	BL CILINDRO SERRETA CS3 L13 40x10mm NI	110	91399	BL FIELTRO ADHESIVO DZ7 34mm BL	288
91178	BL DEDAL EMBUTIR DDL1 12mm NI	138	91285	BL CILINDRO SERRETA CS3 L13 30x30mm NI	110	91400	BL FIELTRO ADHESIVO DZ8 17x17mm BL	289
91179	BL DEDAL EMBUTIR DDL1 14mm NI	138	91286	BL CILINDRO SERRETA CS3 L13 35x35mm NI	110	91401	BL FIELTRO ADHESIVO DZ8 22x22mm BL	289
91180	BL DEDAL EMBUTIR DDL1 20mm NI	138	91287	BL CILINDRO SERRETA CS3 L13 30x40mm NI	110	91402	BL FIELTRO ADHESIVO DZ7 20mm BL	288
91181	BL DEDAL EMBUTIR DDL1 22mm NI	138	91288	BL CILINDRO SERRETA CS3 L13 40x40mm NI	110	91408	BL DESLIZANTE ADHESIVO SD DZ5 20mm GR	287
91182	BL PASADOR ZAMAK P53 35mm LTD	133	91289	BL ALDABA BARCO ADB2 75mm LP	132	91409	BL DESLIZANTE ADHESIVO SD DZ5 25mm GR	287
91183	BL PASADOR ZAMAK P53 50mm LTD	133	91290	BL ALDABA BARCO ADB2 100mm LP	132	91410	BL DESLIZANTE ADHESIVO SD DZ5 30mm GR	287
91184	BL PASADOR ZAMAK P53 35mm CB	133	91291	BL ALDABA BARCO ADB2 125mm LP	132	91411	BL DESLIZANTE ADHESIVO SD DZ5 24x24mm GR	287
91185	BL PASADOR ZAMAK P53 50mm CB	133	91292	BL ALDABA BARCO ADB2 75mm NS	132	91412	BL DESLIZANTE ADHESIVO SD DZ5 30x30mm GR	287
91186	BL PICAPORTE CONDENA C/R PCT2 70mm LTD	168	91293	BL ALDABA BARCO ADB2 100mm NS	132	91413	BL LAGRIMA ADHESIVA LGM1 8x2,2mm TR	258
91								

NUMÉRICO

Código	Descripción	Pág.	Código	Descripción	Pág.	Código	Descripción	Pág.
91420	BL TAPON ADH TPN1 13mm PINTABLE (20)	260	91538	BL PLACA BOCALLAVE PLP2 80x60mm LS	100	91648	BL RUEDA INFERIOR ARMARIO RUA5-H ZN	247
91421	BL TAPON ADH TPN1 13mm CROMADO (20)	260	91539	BL PLACA BOCALLAVE PLP2 80x60mm NS	100	91649	BL RUEDA SUPERIOR ARMARIO RUA4 ZN	246
91422	BL TAPON ADH TPN1 13mm CAOBA (20)	260	91540	BL TORNILLO PASANTE TUBO TRN3 3x60mm ZN	117	91650	BL FRENO SUPERIOR ARMARIO RUA6 ZN	246
91423	BL TAPON ADH TPN1 13mm CEREZO CLARO (20)	260	91541	BL TORNILLO PASANTE TUBO TRN3 4x75mm ZN	117	91651	BL RUEDA INFERIOR ARMARIO RUA3-M NE	246
91424	BL TAPON ADH TPN1 13mm PINO CLARO (20)	260	91542	BL REDUCTOR CUADRADILLO CDD8 7-6mm NE	115	91652	BL RUEDA SUPERIOR ARMARIO RUA1 NE	246
91425	BL TAPON ADH TPN1 13mm ROBLE CLARO (20)	260	91543	BL REDUCTOR CUADRADILLO CDD8 8-7mm NE	115	91653	BL RUEDA SUPERIOR ARMARIO RUA2 ZN	246
91426	BL TAPON ADH TPN1 13mm ROBLE OSCURO (20)	260	91544	BL REDUCTOR CUADRADILLO CDD8 9-8mm NE	115	91654	BL OVALILLO OV2 10x7x1,5mm LT	179
91427	BL TAPON ADH TPN1 13mm CENIZA (20)	260	91545	BL PASADOR ALUMINIO D8 PS5 75mm BL	76	91655	BL OVALILLO OV2 12x8x1,5mm LT	179
91428	BL TAPON ADH TPN1 13mm GRIS BEIGE (20)	260	91546	BL PASADOR ALUMINIO D8 PS5 50mm NE	76	91656	BL OVALILLO OV2 14x9x2mm LT	179
91429	BL TAPON ADH TPN1 13mm PINTABLE (100)	260	91547	BL PASADOR ALUMINIO D8 PS5 75mm NE	76	91657	BL OVALILLO OV2 16x11x2mm LT	179
91430	BL TAPON ADH TPN1 13mm CROMADO (100)	260	91548	BL PASADOR ALUMINIO D8 PS5 75mm PL	76	91658	BL OVALILLO OV2 18x11x2mm LT	179
91431	BL TAPON ADH TPN1 13mm CAOBA (100)	260	91549	BL PASADOR ALUMINIO D8 PS5 75mm OR	76	91659	BL OVALILLO OV2 20x12x2mm LT	179
91432	BL TAPON ADH TPN1 13mm CEREZO CLARO (100)	260	91550	BL POLEA PUERTA CORREDERA POL8 25mm LT	247	91660	BL OVALILLO OV2 22x14x2,5mm LT	179
91433	BL TAPON ADH TPN1 13mm PINO CLARO (100)	260	91551	BL POLEA PUERTA CORREDERA POL8 35mm LT	247	91661	BL OVALILLO OV2 25x15x2,5mm LT	179
91434	BL TAPON ADH TPN1 13mm ROBLE CLARO (100)	260	91552	BL DESLIZANTE ADHESIVO SD DZ5 24x100mm GR	287	91662	BL PICAPORTE TUBULAR C/C PCT3 70mm LTD	169
91435	BL TAPON ADH TPN1 13mm ROBLE OSCURO (100)	260	91553	BL FIELTRO ADHESIVO DZ7 28mm MA	288	91669	BL PICAPORTE TUBULAR C/C PCT3 70mm NS	169
91436	BL TAPON ADH TPN1 13mm CENIZA (100)	260	91554	BL FIELTRO ADHESIVO DZ8 25x25mm MA	289	91670	BL CONDENA PICAPORTE TUBULAR PCT4 LTD	169
91437	BL TAPON ADH TPN1 13mm GRIS BEIGE (100)	260	91555	BL FIELTRO ADHESIVO DZ8 30x30mm MA	289	91671	BL CONDENA PICAPORTE TUBULAR PCT4 NS	169
91438	BL TAPON ADH TPN2 17mm BLANCO (20)	261	91557	BL FIELTRO ADHESIVO DZ8 85x100mm MA	289	91672	BL CERRADERO PICAPORTE CONDENA PCT1 LTD	169
91439	BL TAPON ADH TPN2 17mm NEGRO (20)	261	91558	BL FIELTRO ADHESIVO DZ8 50x100mm MA	289	91673	BL CERRADERO PICAPORTE CONDENA PCT1 NS	169
91440	BL TAPON ADH TPN2 17mm GRIS (20)	261	91559	BL FIELTRO ADHESIVO DZ7 28mm BL	288	91674	BL CERRADERO PICAPORTE TUBULAR PCT3 LTD	169
91441	BL TAPON ADH TPN2 17mm CREMA (20)	261	91560	BL FIELTRO ADHESIVO DZ8 25x25mm BL	289	91675	BL CERRADERO PICAPORTE TUBULAR PCT3 NS	169
91442	BL TAPON ADH TPN2 17mm HAYA (20)	261	91561	BL FIELTRO ADHESIVO DZ8 30x30mm BL	289	91676	BL PICAPORTE RODILLO PCT5 80x18mm BC	170
91443	BL TAPON ADH TPN2 17mm ROBLE (20)	261	91562	BL FIELTRO ADHESIVO DZ8 85x100mm BL	289	91677	BL PICAPORTE RODILLO PCT5 100x21mm BC	170
91444	BL TAPON ADH TPN2 17mm PINO (20)	261	91563	BL FIELTRO ADHESIVO DZ8 50x100mm BL	289	91678	BL PICAPORTE RODILLO PCT5 120x23mm BC	170
91445	BL TAPON ADH TPN2 17mm NOGAL (20)	261	91564	BL PICAPORTE CONDENA C/R PCT1 47mm NE	168	91679	BL PICAPORTE VAIVEN PCT6 60x15mm BC	170
91446	BL TAPON ADH TPN2 17mm MAPLE (20)	261	91565	BL PICAPORTE CONDENA C/R PCT1 47mm CU	168	91680	BL PICAPORTE VAIVEN PCT6 80x18mm BC	170
91447	BL TAPON ADH TPN2 17mm SAPELI (20)	261	91566	BL PICAPORTE CONDENA C/R PCT2 70mm NE	168	91681	BL PICAPORTE VAIVEN PCT6 100x21mm BC	170
91448	BL TAPON ADH TPN2 17mm WENGUE (20)	261	91568	BL ANGULO TRASERA AN22 19x19mm NI	278	91682	BL BISAGRA OCULTA BS2 65x13mm LTD	183
91449	BL TAPON ADH TPN2 17mm CEREZO (20)	261	91569	BL ANGULO TRASERA C/TORN AN21 14x12mm NE	278	91683	BL BISAGRA OCULTA BS2 65x13mm NI	183
91450	BL TAPON ADH TPN2 17mm CEREZO (60)	261	91570	BL TUERCA EMBUTIR TRCS M6x10x13mm ZKN	275	91684	BL BISAGRA OCULTA BS2 65x13mm BR	183
91451	BL LAGRIMA ADHESIVA LGM3 16x7,9mm TR	258	91575	BL SEGURO PERSIANA PR9 120mm BL	393	91685	BL COMPAS CABALLETE BCP10 216x15mm ZN	386
91455	BL DESLIZANTE CLAVO SD DZ4 20mm GR	286	91576	BL SEGURO PERSIANA PR9 120mm NE	393	91686	BL BISAGRA CAZOLETA 30° BC8 35mm ZN	195
91456	BL DESLIZANTE CLAVO SD DZ4 25mm GR	286	91577	BL SEGURO PERSIANA PR9 120mm CB	393	91687	BL BISAGRA CAZOLETA 45° BC9 35mm ZN	195
91457	BL DESLIZANTE CLAVO SD DZ4 30mm GR	286	91578	BL PICAPORTE TUBULAR C/C PCT3 60mm LTD	169	91688	BL TORNILLO EURO TRN17 6.3x7,1x10mm ZN	277
91460	BL ESCUDO BOCALLAVE 6811 BL	77	91579	BL PICAPORTE TUBULAR C/C PCT3 60mm NS	169	91689	BL ESCUDO SEGURIDAD PERA ES2 60mm LS	101
91461	BL ESCUDO BOCALLAVE 6811 NE	77	91580	BL TIRADOR MALETERO 575 IN	11	91690	BL ESCUDO SEGURIDAD PERA ES2 60mm NS	101
91462	BL PASADOR RULETA 6825 ALUM BL	77	91581	BL TIRADOR ARMARIO S/B 575 IN	11	91691	BL ESCUDO SEGURIDAD ES1 63mm LS	101
91463	BL PASADOR RULETA 6825 ALUM NE	77	91582	BL TIRADOR ARMARIO 242 NE	19	91692	BL ESCUDO SEGURIDAD ES1 63mm NS	101
91464	BL PASADOR RULETA 6825 ALUM PL	77	91583	BL TIRADOR ARMARIO S/B 242 NE	19	91693	BL CILINDRO SEGURIDAD CS2 L15 30x60mm LT	106
91465	BL GOLPETE 6810 ALUM BL	75	91584	BL TIRADOR MALETERO 686 LE	20	91694	BL CILINDRO SEGURIDAD CS2 L15 30x60mm NI	106
91466	BL GOLPETE 6810 ALUM NE	75	91585	BL TIRADOR ARMARIO S/B 686 LE	20	91695	BL CILINDRO SEGURIDAD CS2 L15 50x50mm LT	106
91467	BL GOLPETE 6810 ALUM PL	75	91586	BL TIRADOR MALETERO 727 LP	23	91696	BL CILINDRO SEGURIDAD CS2 L15 50x50mm NI	106
91471	BL BISAGRA EU DCHA 6812 ALUM BL	67	91587	BL TIRADOR MALETERO 727 NS	23	91697	BL PASADOR ALUMINIO D8 PS5 100mm NE	76
91472	BL BISAGRA EU IZDA 6812 ALUM BL	67	91588	BL TIRADOR ARMARIO S/B 727 LP	23	91699	BL TOPE PUERTA SETA TP4 20mm NS	126
91473	BL BISAGRA EU DCHA 6812 ALUM NE	67	91589	BL TIRADOR ARMARIO S/B 727 NS	23	91700	BL COLGADOR MUEBLE REVERSIBLE CG8 ZN	325
91474	BL BISAGRA EU IZDA 6812 ALUM NE	67	91590	BL TIRADOR MALETERO 505 CU	24	91703	BL TAPON PLASTICO P/TORNILLO TPN5 5mm BL	262
91475	BL BISAGRA EU DCHA 6812 ALUM PL	67	91591	BL TIRADOR ARMARIO S/B 505 CU	24	91704	BL TAPON PLASTICO P/TORNILLO TPN5 5mm NE	262
91476	BL BISAGRA EU IZDA 6812 ALUM PL	67	91592	BL TIRADOR MALETERO 666 LP	31	91705	BL TAPON PLASTICO P/TORNILLO TPN5 5mm MA	262
91477	BL BISAGRA 40/20 DCHA 6813 ALUM BL	67	91593	BL TIRADOR ARMARIO S/B 666 LP	31	91706	BL TAPON PLASTICO P/TORNILLO TPN5 5mm BE	262
91478	BL BISAGRA 40/20 IZDA 6813 ALUM BL	67	91594	BL TIRADOR MALETERO 777 LP	29	91707	BL TAPON PLASTICO P/TORNILLO TPN5 7mm BL	262
91479	BL BISAGRA 40/20 DCHA 6813 ALUM NE	67	91595	BL TIRADOR ARMARIO S/B 777 LP	29	91708	BL TAPON PLASTICO P/TORNILLO TPN5 7mm NE	262
91480	BL BISAGRA 40/20 IZDA 6813 ALUM NE	67	91599	BL PINZA ZOCALO PVC/ALUMINIO ZCL6 NE	367	91709	BL TAPON PLASTICO P/TORNILLO TPN5 7mm MA	262
91481	BL BISAGRA 40/20 DCHA 6813 ALUM PL	67	91600	BL PASADOR RULETA PS4 40mm LTD	134	91710	BL TAPON PLASTICO P/TORNILLO TPN5 7mm BE	262
91482	BL BISAGRA 40/20 IZDA 6813 ALUM PL	67	91601	BL PASADOR RULETA PS4 40mm CB	134	91711	BL PORTAESTANTE PALETA P1 5mm NI	267
91483	BL CONTRACIERRE ZAMAK 6819-01 ZN	65	91602	BL CILINDRO SEGURIDAD CS2 L15 45x45mm LT	106	91712	BL PORTAESTANTE PERNO PE17 5mm NI	267
91484	BL CONTRACIERRE ZAMAK 6819-02 ZN	65	91603	BL CILINDRO SEGURIDAD CS2 L15 45x45mm NI	106	91713	BL PORTAESTANTE EURO PE18 5mm NI	267
91485	BL CONTRACIERRE ZAMAK 6819-05 ZN	65	91604	BL CILINDRO SERRETA CS3 L15 45x45mm LT	109	91714	BL PORTAESTANTE PE2 5mm NI	265
91486	BL CONTRACIERRE ZAMAK 6819-12 BC	65	91605	BL CILINDRO SERRETA CS3 L15 45x45mm NI	109	91715	BL ENGANCHE+PERNO MADERA EX1 ZN	270
91487	BL CERRADERO LENGÜETA 6818-22 ZN	65	91606	BL CANTO MELAMINA CAN2 22x5mm BLANCO	263	91716	BL ENGANCHE+PERNO EURO EX1 ZN	270
91488	BL CERRADERO LENGÜETA 6818-25 ZN	65	91607	BL CANTO MELAMINA CAN2 22x5mm NEGRO	263	91717	BL ENGANCHE+PERNO PRECISION EX1 ZN	270
91489	BL RUEDA NIDO LATERAL RUM10 35mm ZN	380	91608	BL CANTO MELAMINA CAN2 22x5mm GRIS	263	91718	BL ENGANCHE+SOPORTE TACO EX2 NI	271
91490	BL RUEDA NIDO EMBUTIR RUM11 50mm GR	380	91609	BL CANTO MELAMINA CAN2 22x5mm PINO	263	91719	BL ENGANCHE+SOPORTE TORNILLO EX2 NI	271
91491	BL RUEDA NIDO CIRCULAR RUM12 50mm GR	380	91610	BL CANTO MELAMINA CAN2 22x5mm HAYA	263	91720	BL TUERCA EMBOLO TRC7 M6x10x14mm NI	276
91492	BL TOPE PUERTA CLASICO TP9 BL	124	91611	BL CANTO MELAMINA CAN2 22x5mm WENGUE	263	91723	BL OVALILLO ARANDELA OV3 12mm NI	277
91493	BL TOPE PUERTA CLASICO TP9 MA	124	91612	BL CANTO MELAMINA CAN2 22x5mm NOGAL	263	91724	BL OVALILLO ARANDELA OV3 14mm NI	277
91494	BL TOPE PUERTA RETENEDOR TP10 BL	124	91613	BL CANTO MELAMINA CAN2 22x5mm SAPELI	263	91725	BL OVALILLO ARANDELA OV3 12mm LTD	277
91495	BL TOPE PUERTA RETENEDOR TP10 MA	124	91614	BL CANTO MELAMINA CAN2 22x5mm CEREZO	263	91726	BL OVALILLO ARANDELA OV3 14mm LTD	277
91506	BL GALLETA MADERA ENS9 N°0	284	91615	BL CONTERA CUAD ALETAS CNT3 22x22mm NE	375	91728	BL JGO TORNILLO UNION KOMBY TNE5 M4 NI	281
91507	BL GALLETA MADERA ENS9 N°10	284	91616	BL CONTERA RECT ALETAS CNT4 20x30mm NE	376	91729	BL TAPA NIVELADOR PLANO NV5 30mm CB	371
91508	BL BISAGRA ALAS BS6 80x65mm NE	191	91617	BL CONTERA RECT ALETAS CNT4 25x40mm NE	376	91730	BL TAPA NIVELADOR PLANO NV6 40mm CB	371
91509	BL BISAGRA ALAS BS7 75x45mm NE	191	91618	BL CONTERA RED REFORZADA CNT1 16mm NE	374	91731	BL NIVELADOR PLANO NV5 M6x32mm NE	371
91510	BL BISAGRA ALAS BS7 95x60mm NE	191	91619	BL CONTERA RED REFORZADA CNT1 18mm NE	374	91732	BL NIVELADOR PLANO NV5 M8x38mm NE	371
91511	BL BISAGRA FORMA T BS8 75x75mm NE	191	91620	BL CONTERA RED REFORZADA CNT1 22mm NE	374	91733	BL NIVELADOR PLANO NV6 M8x38mm NE	371
91512	BL BISAGRA FORMA T BS8 100x95mm NE	191	91621	BL CONTERA RED REFORZADA CNT1 28mm NE	374	91734	BL NIVELADOR PLANO NV6 M10x47mm NE	371
91513	BL CIERRE ARCON C8 75x85mm NE	135	91622	BL CONTERA RED REFORZADA CNT1 30mm NE	374	91735	BL NIVELADOR REGULABLE NV3 M6x17mm NE	369
91514	BL CIERRE ARCON C8 95x110mm NE	135	91623	BL CONTERA RED REFORZADA CNT1 32mm NE	374	91738	BL PLACA TRIANGULO C/ROSCA PLC13 M10 ZN	371
91515	BL CIERRE ARCON C9 36x105mm NE	135	91624	ET ANGULO REFUERZO AN1 20x20x19mm BL	308	91739	BL CONTERA CUAD C/ROSCA CNT5 M10x30x30mm NE	374
91516	BL PASADOR FORJA PS11 40mm NE	133	91625	ET ANGULO REFUERZO AN1 30x30x19mm BL	308	91740	BL CONTERA CUAD C/ROSCA CNT5 M10x40x40mm NE	374
91517	BL PASADOR FORJA PS11 50mm NE	133	91626	ET ANGULO REFUERZO AN1 40x40x19mm BL	308	91741	BL CONTERA RED C/ROSCA CNT6 M10x40mm NE	374
91518	BL ALDABA FORJA DCHA ADB4 90x80mm NE	131	91627	ET ANGULO REFUERZO AN1 50x50x19mm BL	308	91742	BL CONTERA RED C/ROSCA CNT6 M10x50mm NE	374
91519	BL ALDABA FORJA IZDA ADB4 90x80mm NE	131	91628	ET ANGULO REFUERZO AN1 60x60x19mm BL	308	91743	BL RECOGEDOR EMBUTIR PR1 14mm BL	388
91520	BL ALDABA FORJA P/8 ADB5 90x65mm NE	131	91629	BL CUADRADILLO RANURADO CDD2 8x80mm ZN	114	91744	BL RECOGEDOR EMBUTIR PR1 14mm GR	388
91521	BL ALDABA FORJA P/25 ADB5 90x65mm NE	131	91630	BL CUADRADILLO RANURADO CDD2 8x90mm ZN	114	91745	BL RECOGEDOR EMBUTIR PR1 14mm MA	388
91522	BL PLACA CIEGA PLP1 60x35mm LP	99	91632	BL CANTO MELAMINA CAN2 22x5mm ROBLE	263	91746	BL RECOGEDOR EMBUTIR PR1 18mm BL	388
91523	BL PLACA CIEGA PLP1 60x35mm LS	99	91633	BL CANTO MELAMINA CAN2 22x5mm ROBLE CLARO	263	91747	BL RECOGEDOR EMBUTIR PR1 18mm GR	388
91524	BL PLACA CIEGA PLP1 60x35mm NS	99	91634	BL CANTO MELAMINA CAN2 22x5mm ROBLE OSCURO	263	91748	BL RECOGEDOR EMBUTIR PR1 18mm MA	388
91525	BL PLACA CIEGA PLP1 60x80mm LP	99	91635	BL CANTO ADHESIVO CAN1 19x5mm BLANCO	263	91749	BL RECOGEDOR ABATIBLE PR2 14mm BL	388
91526	BL PLACA CIEGA PLP1 60x80mm LS	99	91636	BL CANTO ADHESIVO CAN1 19x5mm NEGRO	263	91750	BL RECOGEDOR ABATIBLE PR2 14mm GR	388
91527	BL PLACA CIEGA PLP1 60x80mm NS	99	91637	BL CANTO ADHESIVO CAN1 19x5mm GRIS	263	91751	BL RECOGEDOR ABATIBLE PR2 14mm MA	388
91528	BL PLACA CIEGA PLP1 80x80mm LP	99	91638	BL CANTO ADHESIVO CAN1 19x5mm PINO	263	91752	BL RECOGEDOR ABATIBLE PR2 14mm MF	388
91529	BL PLACA CIEGA PLP1 80x80mm LS	99	91639	BL CANTO ADHESIVO CAN1 19x5mm HAYA	263	91753	BL RECOGEDOR ABATIBLE PR2 18mm BL	388
91530	BL PLACA CIEGA PLP1 80x80mm NS	99	91640	BL CANTO ADHESIVO CAN1 19x5mm WENGUE	263	91754	BL RECOGEDOR ABATIBLE PR2 18mm GR	388
91531	BL PLACA BOCALLAVE PLP2 60x35mm LP	100	91641	BL CANTO ADHESIVO CAN1 19x5mm NOGAL	263	91755	BL RECOGEDOR ABATIBLE PR2 18mm MA	388
91532	BL PLACA BOCALLAVE PLP2 60x35mm LS	100	91642	BL CANTO ADHESIVO CAN1 19x5mm SAPELI	263	91756	BL RECOGEDOR ABATIBLE PR2 18mm MF	388
91533	BL PLACA BOCALLAVE PLP2 60x35mm NS	100	91643	BL CANTO ADHESIVO CAN1 19x5mm CEREZO	263	91757	BL RECOGEDOR PLASTICO PEGUEÑO PR4 BL	389
91534	BL PLACA BOCALLAVE PLP2 60x80mm LP	100	91644	BL CANTO ADHESIVO CAN1 19x5mm ROBLE	263	91758	BL RECOGEDOR PLASTICO GRANDE PR4 BL	389
91535	BL PLACA BOCALLAVE PLP2 60x80mm LS	100	91645	BL CANTO ADHESIVO CAN1 19x5mm ROBLE CLARO	263	91759	BL RECOGEDOR METALICO PR5 ZN	389
91536	BL PLACA BOCALLAVE PLP2 60x80mm NS	100	91646	BL CANTO ADHESIVO CAN1 19x5mm ROBLE OSCURO	263	91760		

NUMÉRICO

Código	Descripción	Pág.	Código	Descripción	Pág.	Código	Descripción	Pág.
91762	BL EMBELLECEDOR P/RECOGEDOR PR6 OR	389	91869	BL CILINDRO SERRETA POMO CS7 L15 40x40mm NS	111	91976	BL CIERRE CAJA CANDADO CC1 100x34mm ZN	290
91763	BL EMBELLECEDOR P/RECOGEDOR PR6 BR	389	91870	BL CILINDRO SERRETA POMO CS7 L15 30x50mm LT	111	91977	BL CIERRE CAJA CC2 42x23mm ZN	290
91766	BL GUIA CINTA PERSIANA PLASTICO PR10 BL	390	91871	BL CILINDRO SERRETA POMO CS7 L15 30x50mm NS	111	91978	BL CIERRE CAJA CANDADO CC2 42x23mm ZN	290
91767	BL GUIA CINTA PERSIANA METALICA PR11 BL	390	91872	BL BISAGRA CAZOLETA 90° RINCONERA BC12 ZN	195	91979	BL CIERRE CAJA CC4 50x22mm ZN	291
91768	BL GUIA CINTA PERSIANA METALICA PR11 AL	390	91873	BL EXCENTRICA 25 EX7+PERNO R/M EX6 ZAMAK	274	91980	BL CIERRE CAJA CC5 70x28mm ZN	291
91769	BL CARCASA GUIA CINTA PR12 BL	390	91874	BL EXCENTRICA 25 EX7+PERNO M6 EX6 ZAMAK	274	91981	BL CIERRE CAJA REGULABLE CC6 138-150mm ZN	291
91770	BL CARCASA GUIA CINTA PR12 AL	390	91875	BL CIERRE BOLA IM6 44mm NS	248	91982	BL CERRADURA ARCHIVADOR CM10 18mm CB	243
91771	BL SOPORTE PINCHO PR14 ZN	391	91876	BL CIERRE BOLA IM6 50mm NS	248	91983	BL VARILLA HUECA VR1 M10/100x20mm+TUERCA TRC9 ZN	294
91772	BL SOPORTE RODILLOS PR13 ZN	390	91877	BL CIERRE BOLA IM6 70mm NS	248	91984	BL VARILLA HUECA VR1 M10/100x40mm+TUERCA TRC9 ZN	294
91773	BL SOPORTE PR15+RODAMIENTO PR16 28mm ZN	391	91878	BL CERRADURA ARMARIO CM9 22mm CB	240	91985	BL VARILLA HUECA VR1 M10/100x100mm+TUERCA TRC9 ZN	294
91774	BL TOPE PERSIANA PR8 40mm BL	394	91880	BL MIRILLA 16mm 180° MR2 35/60mm LTD	96	91986	BL TUERCA TRC9 M10/100x13x4mm ZN	294
91775	BL TOPE PERSIANA PR8 40mm GR	394	91881	BL MIRILLA 16mm 180° MR2 35/60mm NS	96	91987	BL TAPON MODULO CREMALLERA TPN7 5mm BL	262
91776	BL TOPE PERSIANA PR8 40mm MA	394	91882	BL TOPE PUERTA STOP ADHESIVO TP11 IN	127	91988	BL TAPON MODULO CREMALLERA TPN7 5mm GR	262
91777	BL TOPE PERSIANA PR8 40mm MF	394	91885	BL OVALILLO PERNO OV1 IN	179	91989	BL TORNILLO DOWELL TRN9 M4x30mm ZN	282
91778	BL TOPE PERSIANA PR8 60mm BL	394	91886	BL COLGADOR CUADROS DENTADO CG19 LTD	327	91990	BL TORNILLO DOWELL TRN9 M6x40mm ZN	282
91779	BL TOPE PERSIANA PR8 60mm GR	394	91887	BL POLEA TENDER C/GANCHO POL6 40mm ZN	411	91991	BL TORNILLO DOWELL TRN9 M6x60mm ZN	282
91780	BL TOPE PERSIANA PR8 60mm MA	394	91888	BL POLEA TENDER C/GANCHO POL5 40mm ZN	411	91993	BL TORNILLO DOWELL TRN9 M8x60mm ZN	282
91781	BL TOPE PERSIANA PR8 60mm MF	394	91891	BL RODAMIENTO MOSQUITERA RD5 21mm NE	90	91994	BL TORNILLO DOWELL TRN9 M8x70mm ZN	282
91782	BL CINTA PERSIANA PR26 14x6mts BL	396	91892	BL RODAMIENTO MOSQUITERA RD5 23mm NE	90	91995	BL TORNILLO DOWELL TRN9 M8x80mm ZN	282
91783	BL CINTA PERSIANA PR26 14x6mts GR	396	91893	BL RODAMIENTO VITRINA RD29 ZN	85	91996	BL TORNILLO DOWELL TRN9 M8x100mm ZN	282
91784	BL CINTA PERSIANA PR26 14x6mts MA	396	91894	BL RODAMIENTO VITRINA RD30 NE	85	91997	BL TORNILLO DOWELL TRN9 M10x50mm ZN	282
91785	BL CINTA PERSIANA PR26 14x6mts BE	396	91895	BL RODAMIENTO REGULABLE INASA 2000 RD34 ZN	84	91998	BL TORNILLO DOWELL TRN9 M10x60mm ZN	282
91786	BL CINTA PERSIANA PR26 14x6mts BU/PINTAS	396	91896	BL RODAMIENTO REGULABLE INASA 300 RD35 ZN	84	91999	BL TORNILLO DOWELL TRN9 M10x90mm ZN	282
91789	BL CINTA PERSIANA PR26 18x6mts BL	396	91897	BL RODAMIENTO CO-1B RD31 AL	85	92001	TUBO ARMARIO LED+MOVIMIENTO LD1 PL*	227
91790	BL CINTA PERSIANA PR26 18x6mts BU/PINTAS	396	91898	BL RODAMIENTO ALTA 300 RD11 BL	81	92002	LED C/SENSOR MULTIFUSO LD2 BL	227
91791	BL CINTA PERSIANA PR26 18x6mts GR	396	91899	BL RODAMIENTO ELITE VENTANA RD23 NE	82	92100	BL TORNILLO DOWELL TRN9 M10x100mm ZN	282
91792	BL CINTA PERSIANA PR26 18x6mts BE	396	91900	BL RODAMIENTO TRIANA RD24 NE	82	92101	BL ESPARRAGO 2 ROSCAS TRN14 4x40mm ZN	283
91793	BL CINTA PERSIANA PR26 22x6mts BL	396	91901	BL RODAMIENTO ALUPRON 21 RD21 NE	81	92110	BL TORNILLO CASCABEL TRN15 9x40mm BC	282
91794	BL CINTA PERSIANA PR26 22x6mts GR/BL	396	91902	BL RODAMIENTO P-60 RD22 NE	81	92111	BL TORNILLO CASCABEL TRN15 9x60mm BC	282
91795	BL CINTA PERSIANA PR26 22x6mts BE/BL	396	91903	BL RODAMIENTO MAMPARA RD25 BL	88	92112	BL TORNILLO CASCABEL TRN15 9x80mm BC	282
91796	BL RODAMIENTO MAMPARA RD1 16mm NE	87	91904	BL RODAMIENTO MAMPARA RD26 BL	88	92113	BL TORNILLO CASCABEL TRN15 9x100mm BC	282
91797	BL RODAMIENTO MAMPARA TUBO RD2 22mm BL	89	91905	BL RODAMIENTO MAMPARA RD27 BL	88	92114	BL TORNILLO CAMA TRN12 9x60mm BC	292
91798	BL RODAMIENTO MAMPARA TUBO RD2 24mm BL	89	91906	BL RODAMIENTO MAMPARA RD28 BL	88	92115	BL TORNILLO CAMA TRN12 9x80mm BC	292
91799	BL RODAMIENTO MAMPARA ART RD3 26mm BL	89	91907	BL CONTERA RED FLEXIBLE CNT7 10mm BL	373	92116	BL TORNILLO CAMA TRN12 9x100mm BC	292
91800	BL RODAMIENTO ALUGOM 400 RD20 NE	81	91908	BL CONTERA RED FLEXIBLE CNT7 12mm BL	373	92117	BL TUERCA RECTANGULAR TRC 190 9x16mm BC	292
91801	BL ESPIRAL VISILLO FORRADO EV1 2mts BL	226	91909	BL CONTERA RED FLEXIBLE CNT7 14mm BL	373	92118	BL ESPARRAGO R/MADERA TRN13 8x60mm ZN	283
91802	BL CIERRE CORREDERA 6820 ALUM BL	62	91910	BL CONTERA RED FLEXIBLE CNT7 16mm BL	373	92119	BL ESPARRAGO R/MADERA TRN13 8x70mm ZN	283
91803	BL CIERRE CORREDERA 6820 ALUM NE	62	91911	BL CONTERA RED FLEXIBLE CNT7 18mm BL	373	92120	BL ESPARRAGO R/MADERA TRN13 8x75mm ZN	283
91804	BL CIERRE CORREDERA 6821 ALUM BL	63	91912	BL CONTERA RED FLEXIBLE CNT7 20mm BL	373	92121	BL GARFIO CORTINA FRENTE CT ZN	237
91805	BL CIERRE CORREDERA 6821 ALUM NE	63	91913	BL CONTERA RED FLEXIBLE CNT7 22mm BL	373	92122	BL GARFIO CORTINA TECHO CT8 ZN	237
91806	BL CIERRE CORREDERA 6822 ALUM BL	63	91914	BL CONTERA RED FLEXIBLE CNT7 25mm BL	373	92123	BL CORCHETE CORTINA CT9 ZN	237
91807	BL CIERRE CORREDERA 6822 ALUM NE	63	91915	BL CONTERA RED FLEXIBLE CNT7 28mm BL	373	92124	BL CORCHETE CORTINA COSER CT12 BL	237
91808	BL CIERRE CORREDERA 6823 ALUM BL	63	91916	BL CONTERA RED FLEXIBLE CNT7 30mm BL	373	92125	BL CORCHETE CORTINA COSER CT11 ZN	238
91809	BL CIERRE CORREDERA 6823 ALUM NE	63	91917	BL CONTERA RED FLEXIBLE CNT7 32mm BL	373	92126	BL CORCHETE GUIA RIEL CT10 BL	238
91810	BL CREMONA 2 PATILLAS 6814 ALUM BL	69	91918	BL CONTERA RED FLEXIBLE CNT7 35mm BL	373	92127	BL ALFILER VISILO CT13 ZN	238
91811	BL CREMONA 2 PATILLAS 6814 ALUM NE	69	91919	BL CONTERA RED FLEXIBLE CNT7 10mm NE	373	92128	BL NIVELADOR REGULABLE NV3 M6x17mm BL	369
91812	BL CREMONA 2 PATILLAS 6815 ALUM BL	69	91920	BL CONTERA RED FLEXIBLE CNT7 12mm NE	373	92129	BL CIERRE CORREDERA PULSAR 6841 ALUM BL	66
91813	BL CREMONA 2 PATILLAS 6815 ALUM NE	69	91921	BL CONTERA RED FLEXIBLE CNT7 14mm NE	373	92130	BL CREMONA PATILLA U 6831 ALUM BL	70
91814	BL CREMONA 2 PATILLAS 6816 ALUM BL	69	91922	BL CONTERA RED FLEXIBLE CNT7 16mm NE	373	92131	BL ANILLA C/PLACA TOLDOS AP3 ZN	331
91815	BL CREMONA 2 PATILLAS 6816 ALUM NE	69	91923	BL CONTERA RED FLEXIBLE CNT7 18mm NE	373	92132	BL ANILLA C/PLACA TOLDOS AP3 AISI316	331
91816	BL CREMONA 2 PATILLAS 6817 ALUM BL	69	91924	BL CONTERA RED FLEXIBLE CNT7 20mm NE	373	92133	BL CONTERA RED CAUCHO CNT8 16-17mm NE	373
91817	BL CREMONA 2 PATILLAS 6817 ALUM NE	69	91925	BL CONTERA RED FLEXIBLE CNT7 22mm NE	373	92134	BL CONTERA RED CAUCHO CNT8 18-19mm NE	373
91818	BL MULETILLA MANILLA 10014 LP	52	91926	BL CONTERA RED FLEXIBLE CNT7 25mm NE	373	92135	BL CONTERA RED CAUCHO CNT8 20-21mm NE	373
91819	BL MULETILLA MANILLA 10014 NS	52	91927	BL CONTERA RED FLEXIBLE CNT7 28mm NE	373	92136	BL CONTERA RED CAUCHO CNT8 25-26mm NE	373
91820	BL SOPORTE PELICANO SP8 42x53mm BL	300	91928	BL CONTERA RED FLEXIBLE CNT7 30mm NE	373	92137	BL JGO ENGANCHE MOSQUITERA MQ1 BL	90
91821	BL SOPORTE PELICANO SP8 42x53mm OR	300	91929	BL CONTERA RED FLEXIBLE CNT7 32mm NE	373	92138	BL JGO ENGANCHE MOSQUITERA MQ1 ZN	90
91822	BL SOPORTE PELICANO SP8 42x53mm CM	300	91930	BL CONTERA RED FLEXIBLE CNT7 35mm NE	373	92139	BL ANILLA SOLDADA C/HEMBRILLA AP4 ZN	330
91823	BL TAPON ADH TPN1 13mm TEXTIL OSCURO (100)	260	91931	BL CONTERA P/MULETAS CNT9 18-19mm NE	374	92140	BL ANILLA SOLDADA C/PLACA AP6 ZN	330
91824	BL TAPON ADH TPN1 13mm TEXTIL CLARO (100)	260	91932	BL CIERRE CONTRAVENTANA 6840 ALUM BL	57	92141	BL GANCHO C/PLACA FLO AP7 ZN	330
91825	BL TAPON ADH TPN1 13mm TEXTIL BEIGE (100)	260	91933	BL CIERRE CONTRAVENTANA 6840 ALUM NE	57	92142	BL GANCHO C/PLACA MOVIL AP5 ZN	330
91826	BL TAPON ADH TPN1 13mm TEXTIL OSCURO (20)	260	91934	BL CIERRE CORREDERA LLI 6847 ALUM BL	66	92143	BL 2 CILINDRO SERRETA CS3 LLI L15 30x30mm LT	109
91827	BL TAPON ADH TPN1 13mm TEXTIL CLARO (20)	260	91935	BL CIERRE CORREDERA LLI 6847 ALUM NE	66	92144	BL 2 CILINDRO SERRETA CS3 LLI L15 30x30mm NI	109
91828	BL TAPON ADH TPN1 13mm TEXTIL BEIGE (20)	260	91937	BL CIERRE CORREDERA PULSAR 6841 ALUM NE	66	92145	BL 2 CILINDRO SERRETA CS3 LLI L15 35x35mm LT	109
91829	BL ANILLA P/LLAVE LLV3 SURTIDO	414	91938	BL CIERRE CORREDERA LLI 6841 ALUM BL	66	92146	BL 2 CILINDRO SERRETA CS3 LLI L15 35x35mm NI	109
91833	BL CILINDRO SERRETA CS3 L15 23x23mm LT	109	91939	BL CIERRE CORREDERA LLI 6841 ALUM NE	66	92147	BL 2 CILINDRO SERRETA CS3 LLI L15 30x40mm LT	109
91834	BL CILINDRO SERRETA CS3 L15 23x23mm NI	109	91940	BL CREMONA 1 PATILLA 6828 ALUM BL	70	92148	BL 2 CILINDRO SERRETA CS3 LLI L15 30x40mm NI	109
91835	BL TUERCA EMBUTIR TRC5 M8x12x18mm ZKN	275	91941	BL CREMONA 1 PATILLA 6828 ALUM NE	70	92149	BL 2 CILINDRO SERRETA CS3 LLI L15 40x40mm LT	109
91836	BL CILINDRO SEGURIDAD CS2 L13 30x30mm LT	107	91942	BL CREMONA 2 PATILLAS 6829 ALUM BL	70	92150	BL 2 CILINDRO SERRETA CS3 LLI L15 40x40mm NI	109
91837	BL CILINDRO SEGURIDAD CS2 L13 35x35mm LT	107	91943	BL CREMONA 2 PATILLAS 6829 ALUM NE	70	92151	BL TIRANTE C/LEJE PR18 GR	393
91838	BL CILINDRO SEGURIDAD CS2 L13 30x40mm LT	107	91944	BL CREMONA 2 PATILLAS LLI/ 6830 ALUM BL	70	92152	BL SEGURO PERSIANA PASADOR PR22 6x80mm BC	393
91839	BL CILINDRO SEGURIDAD CS2 L13 40x40mm LT	107	91945	BL CREMONA 2 PATILLAS LLI/ 6830 ALUM NE	70	92153	BL TORNILLO TRN10+TUERCA SILLA TRC8 3/16x15mm NI	283
91840	BL CILINDRO SEGURIDAD CS2 L13 30x50mm LT	107	91947	BL CREMONA PATILLA U 6831 ALUM NE	70	92154	BL TORNILLO TRN10+TUERCA SILLA TRC8 3/16x20mm NI	283
91841	BL CILINDRO SEGURIDAD CS2 L13 30x50mm NI	107	91948	BL CREMONA+MANETA SEGURIDAD 6833 ALUM BL	71	92155	BL TORNILLO TRN10+TUERCA SILLA TRC8 3/16x25mm NI	283
91842	BL CILINDRO SERRETA CS3 L15 30x10mm LT	109	91949	BL CREMONA+MANETA SEGURIDAD 6833 ALUM NE	71	92156	BL TORNILLO TRN10+TUERCA SILLA TRC8 3/16x30mm NI	283
91843	BL CILINDRO SERRETA CS3 L15 30x10mm NI	109	91950	BL CREMONA+MANETA SEGURIDAD 6834 ALUM BL	72	92157	BL TORNILLO TRN10+TUERCA SILLA TRC8 3/16x35mm NI	283
91844	BL CILINDRO SERRETA CS3 L15 40x10mm LT	109	91951	BL CREMONA+MANETA SEGURIDAD 6834 ALUM NE	72	92158	BL TORNILLO TRN10+TUERCA SILLA TRC8 3/16x40mm NI	283
91845	BL CILINDRO SERRETA CS3 L15 40x10mm NI	109	91952	BL CREMONA C/MUELLE 6832 ALUM BL	71	92159	BL TORNILLO TRN10+TUERCA SILLA TRC8 3/16x45mm NI	283
91846	BL CILINDRO SERRETA CS3 L13 30x30mm LT	110	91953	BL CREMONA C/MUELLE 6832 ALUM NE	71	92160	BL TORNILLO TRN10+TUERCA SILLA TRC8 3/16x60mm NI	283
91847	BL CILINDRO SERRETA CS3 L13 35x35mm LT	110	91954	BL CREMONA AC-20 OLD 6835 ALUM BL	73	92161	BL TORNILLO TRN10+TUERCA SILLA TRC8 3/16x70mm NI	283
91848	BL CILINDRO SERRETA CS3 L13 30x40mm LT	110	91955	BL CREMONA AC-20 NEW 6835 ALUM BL	73	92162	BL CIERRE CAJA C/LLAVE CC7 131x43mm NE	291
91849	BL CILINDRO SERRETA CS3 L13 40x40mm LT	110	91956	BL CREMONA AC-20 OLD 6835 ALUM NE	73	92165	BL ANILLA SOLDADA C/HEMBRILLA AP4 NE	330
91850	BL CILINDRO SERRETA CS3 L13 30x50mm LT	110	91957	BL CREMONA AC-20 NEW 6835 ALUM NE	73	92166	BL ANILLA SOLDADA C/PLACA AP6 NE	330
91851	BL CILINDRO SERRETA CS3 L13 30x50mm NI	110	91958	BL CIERRE CORREDERA 6836 PLASTICO BL	64	92167	BL GANCHO C/PLACA FLO AP7 NE	330
91852	BL CILINDRO SEGURIDAD POMO CS6 L15 30x30mm LT	111	91959	BL CIERRE CORREDERA 6836 PLASTICO NE	64	92168	BL GANCHO C/PLACA MOVIL AP5 NE	330
91853	BL CILINDRO SEGURIDAD POMO CS6 L15 30x30mm NS	111	91960	BL CONTRACIERRE ZAMAK 6819-90 NE	65	92169	BL CIERRE CORREDERA LLI 6826 ALUM BL	64
91854	BL CILINDRO SEGURIDAD POMO CS6 L15 35x35mm LT	111	91961	BL CONTRACIERRE ZAMAK 6819-90 ZN	65	92170	BL CIERRE CORREDERA LLI 6826 ALUM NE	64
91855	BL CILINDRO SEGURIDAD POMO CS6 L15 35x35mm NS	111	91962	BL CONTRACIERRE ZAMAK 6819-06 ZN	65	92171	BL FIELTRO ADHESIVO D29 85x1mt MA	288
91856	BL CILINDRO SEGURIDAD POMO CS6 L15 30x40mm LT	111	91963	BL CONTRACIERRE ZAMAK 6819-08 ZN	65	92172	BL FIELTRO ADHESIVO D29 85x1mt BL	288
91857	BL CILINDRO SEGURIDAD POMO CS6 L15 30x40mm NS	111	91964	BL CERRADERO LENGÜETA 6818-01 ZN	65	92173	BL CUERDA P/TORNO PERSIANA PR17 6mts BL	393
91858	BL CILINDRO SEGURIDAD POMO CS6 L15 40x40mm LT	111	91965	BL CERRADERO LENGÜETA 6818-02 ZN	65	92174	BL ANILLA REDONDA CT17 8mm BL	236
91859	BL CILINDRO SEGURIDAD POMO CS6 L15 40x40mm NS	111	91966	BL CIERRE CORREDERA 6845 ALUM BL	62	92175	BL ANILLA REDONDA CT17 10mm BL	236
91860	BL CILINDRO SEGURIDAD POMO CS6 L15 30x50mm LT	111	91967	BL CIERRE CORREDERA 6845 ALUM NE	62	92176	BL ANILLA REDONDA CT17 13mm BL	236
91861	BL CILINDRO SEGURIDAD POMO CS6 L15 30x50mm NS	111	91968	BL BISAGRA COMPAS EUROPEO 6838 ALUM BL	75	92177	BL ANILLA REDONDA CT17 16mm BL	236
91862	BL CILINDRO SERRETA POMO CS7 L15 30x30mm LT	111	91969	BL BISAGRA COMPAS EUROPEO 6838 ALUM NE	75	92178	BL ANILLA REDONDA CT17 18mm BL	236
91863	BL CILINDRO SERRETA POMO CS7 L15 30x30mm NS	111	91970	BL BISAGRA COMPAS DESMONTABLE 6839 ALUM BL	75	92179	BL ANILLA REDONDA CT17 20mm BL	236
91864	BL CILINDRO SERRETA POMO CS7 L15 35x35mm LT	111	91971	BL BISAGRA COMPAS DESMONTABLE 6839 ALUM NE	75	92180	BL ANILLA REDONDA CT17 22mm BL	236
91865	BL CILINDRO SERRETA POMO CS7 L15 35x35mm NS	111	91972	BL POLEA SUPERIOR ESCUADRA POL9 BC	247	92181	BL ANILLA REDONDA CT17 25mm BL	236
91866	BL CILINDRO SERRETA POMO							

NUMÉRICO

Código	Descripción	Pág.	Código	Descripción	Pág.	Código	Descripción	Pág.
92185	BL KIT MOSQUITERA CORREDERA GDE MQ2 NE	90	92295	BL KIT ABATIBLE 2ª HOJA EUROPEO 6853 NE	74	92395	BL NEODIMIO ARO AVELLANADO IM31 10x3mm (8-4) NI	256
92186	BL KIT MOSQUITERA CORREDERA PEQ MQ2 BL	90	92296	BL CIERRE PRESION 6857 ALUM BL	57	92396	BL NEODIMIO ARO AVELLANADO IM31 12x6mm (8-4) NI	256
92187	BL KIT MOSQUITERA CORREDERA PEQ MQ2 NE	90	92297	BL CIERRE PRESION 6857 ALUM NE	57	92397	BL NEODIMIO ARO AVELLANADO IM31 15x4mm (8-4) NI	256
92188	BL TORNILLO CILINDRO TRN16 M5x65mm LTD	112	92298	BL CIERRE CORREDERA LLI1 6859 ALUM BL	64	92398	BL NEODIMIO ARO AVELLANADO IM31 18x4mm (8-4) NI	256
92189	BL TORNILLO CILINDRO TRN16 M5x65mm NI	112	92299	BL CIERRE CORREDERA LLI1 6859 ALUM NE	64	92399	BL NEODIMIO ARO AVELLANADO IM31 20x3mm (8-4) NI	256
92190	BL CILINDRO SEGURIDAD CS1 L15 30x30mm LT	102	92300	BL JGO BISAGRA CRISTAL BSC22 NI	185	92400	BL NEODIMIO ARO AVELLANADO IM31 25x6mm (6,7-3,1) NI	256
92191	BL CILINDRO SEGURIDAD CS1 L15 30x30mm NI	102	92301	BL BISAGRA COMPAS IZDA BCP9 200mm LTD	385	92401	BL NEODIMIO ARO AVELLANADO IM31 30x5mm (12-6) NI	256
92192	BL CILINDRO SEGURIDAD CS1 L15 35x35mm LT	102	92302	BL BISAGRA COMPAS DCHA BCP9 200mm LTD	385	92402	BL NEODIMIO ARO AVELLANADO IM31 32x7mm (5,5-1,1) NI	256
92193	BL CILINDRO SEGURIDAD CS1 L15 35x35mm NI	102	92303	BL BISAGRA COMPAS IZDA BCP9 250mm LTD	385	92403	BL FERRITA DISCO IM34 12x2,5mm NE	257
92194	BL CILINDRO SEGURIDAD CS1 L15 30x40mm LT	102	92304	BL BISAGRA COMPAS DCHA BCP9 250mm LTD	385	92404	BL FERRITA DISCO IM34 22x3mm NE	257
92195	BL CILINDRO SEGURIDAD CS1 L15 30x40mm NI	102	92305	BL BISAGRA COMPAS IZDA BCP9 200mm NI	385	92405	BL FERRITA DISCO IM34 25x5mm NE	257
92196	BL CILINDRO SEGURIDAD CS1 L13 30x30mm NI	102	92306	BL BISAGRA COMPAS DCHA BCP9 200mm NI	385	92406	BL FERRITA BLOQUE IM35 20x10x5mm NE	257
92197	BL CILINDRO SEGURIDAD CS1 L13 35x35mm NI	102	92307	BL BISAGRA COMPAS IZDA BCP9 250mm NI	385	92407	BL FERRITA BLOQUE IM35 40x20x10mm NE	257
92198	BL CILINDRO SEGURIDAD CS1 L13 30x40mm NI	102	92308	BL BISAGRA COMPAS DCHA BCP9 250mm NI	385	92408	BL CADENA BOLAS MONTADA CDN8 3,2x250mm CB	410
92199	BL PERNIO S/R DCHA PN9 95x54mm LTD	177	92309	BL CONTERA RED FLEXIBLE CNT10 20mm TR	372	92409	BL CADENA BOLAS MONTADA CDN8 4x400mm CB	410
92200	BL PERNIO S/R IZDA PN9 95x54mm LTD	177	92310	BL CONTERA RED FLEXIBLE CNT10 25mm TR	372	92410	BL JGO GRAPA SUJECION FREGADERO GRP3 NI	349
92201	BL PERNIO S/R DCHA PN9 95x54mm NS	177	92311	BL CONTERA RED FLEXIBLE CNT10 30mm TR	372	92411	BL JGO GRAPA SUJECION FREGADERO GRP4 NI	349
92202	BL PERNIO S/R IZDA PN9 95x54mm NS	177	92312	BL CUÑA NIVELADORA NV14 60x30x97mm TR	287	92412	BL BURLETE FREGADERO BLT12 GR	349
92203	BL RUEDA EMBUTIR RUM1 22mm NE	379	92313	BL DESLIZANTE ATORNILLAR GOMA DZ10 20mm TR	287	92413	BL TORNILLO PRISIONERO MANILLA TRN4 M6x6mm IN	117
92204	BL COMPAS ESCALERA BCP11 190x30mm ZN	386	92314	BL DESLIZANTE ATORNILLAR GOMA DZ10 25mm TR	287	92414	BL CADENA REDONDA GRABADA CDN5 3,4x43x1mt LTD	409
92205	BL PLACA CTUERCA PLC12 M8x50x50mm ZN	317	92315	BL OVALILLO OV2 10x7x2mm LT	179	92415	BL CADENA REDONDA GRABADA CDN5 3,4x43x1mt NI	409
92206	BL PLACA CTUERCA PLC12 M10x50x50mm ZN	317	92316	BL OVALILLO OV2 12x8x2mm LT	179	92416	BL CADENA REDONDA GRABADA CDN5 3,4x43x1mt NE	409
92207	BL PERNIO S/R DCHA PN7 80x50mm IN	177	92317	BL OVALILLO OV2 14x9x3mm LT	179	92417	BL LLAVE MULTIPLE CONTADOR LLV4 NI	416
92208	BL PERNIO S/R IZDA PN7 80x50mm IN	177	92318	BL OVALILLO OV2 16x11x3mm LT	179	92418	BL BISAGRA FORMA T BS23 100mm ZN	190
92209	BL TORNILLO CILINDRO TRN16 M5x85mm LTD	112	92319	BL OVALILLO OV2 18x11x3mm LT	179	92419	BL BISAGRA FORMA T BS23 130mm ZN	190
92210	BL TORNILLO CILINDRO TRN16 M5x85mm NI	112	92320	BL OVALILLO OV2 20x12x3mm LT	179	92420	BL BISAGRA FORMA T BS23 150mm ZN	190
92212	BL TOPE PUERTA LUX ADH TP7 47mm GR	125	92321	BL OVALILLO OV2 SURTIDO LT	179	92421	BL BISAGRA FORMA T BS23 175mm ZN	190
92213	BL RODAMIENTO MAMPARA RD1 20mm C/SEPARADOR 6mm NE	87	92322	BL TAPON PASACABLES TPC1 80x22mm BL	219	92422	BL BISAGRA FORMA T BS23 100mm NE	190
92214	BL RODAMIENTO MAMPARA RD1 20mm C/SEPARADOR 12mm NE	87	92323	BL ESCUDO SEGURIDAD ES3 65mm LS	101	92423	BL BISAGRA FORMA T BS23 130mm NE	190
92215	BL RODAMIENTO MAMPARA RD1 20mm C/SEPARADOR 17mm NE	87	92324	BL ESCUDO SEGURIDAD ES3 65mm NS	101	92424	BL BISAGRA FORMA T BS23 150mm NE	190
92216	BL RODAMIENTO MAMPARA RD1 26mm C/SEPARADOR 6mm NE	87	92325	BL JGO BISAGRA CRISTAL BSC23 CB	185	92425	BL BISAGRA FORMA T BS23 175mm NE	190
92217	BL RODAMIENTO MAMPARA RD1 26mm C/SEPARADOR 12mm NE	87	92326	BL CREMONA FRONTAL 6863 ZAMAK BL/NE	73	92426	BL LED C/SENSOR MULTISIO LD2 BL	227
92218	BL RODAMIENTO MAMPARA RD1 26mm C/SEPARADOR 17mm NE	87	92327	BL CIERRE CORREDERA PULSAR 6865 ALUM BL	66	92427	BL RETENEDOR FORMA S RTE 130x100mm NE	129
92219	BL SEPARADOR PIRODAMIENTO MAMPARA RD1 6mm LT	87	92328	BL CIERRE CORREDERA PULSAR 6865 ALUM NE	66	92428	BL JGO COLGADOR COCINA OCULTO CG65 ZN	324
92220	BL SEPARADOR PIRODAMIENTO MAMPARA RD1 12mm LT	87	92329	BL CIERRE CORREDERA PULSAR 6865 ALUM PL	66	92297	BISAGRA COMPAS BCP12 150mm ZN	385
92221	BL SEPARADOR PIRODAMIENTO MAMPARA RD1 17mm LT	87	92330	BL MEDIA LUNA MDL1 M6x32mm	276	92298	BISAGRA COMPAS BCP12 200mm ZN	385
92222	BL RODAMIENTO REGULABLE ALUGOM 400 RD36 ZN	86	92331	BL MEDIA LUNA MDL1 M8x32mm	276	92299	BISAGRA COMPAS BCP12 250mm ZN	385
92223	BL RODAMIENTO REGULABLE ALUPRON 21 RD37 ZN	86	92332	BL MEDIA LUNA MDL2 6x28mm BL	276	93000	BISAGRA COMPAS BCP12 300mm ZN	385
92224	BL RODAMIENTO REGULABLE SILVER 60 RD38 ZN	86	92333	BL COLGADOR MUEBLE EMBUTIR CG22 ZN	326	93003	PISTON GAS ELEVABLE BCP1 8kgs AL	383
92225	BL RODAMIENTO REGULABLE P60/P65 RD39 ZN	86	92334	BL BISAGRA COMPAS BCP12 150mm ZN	385	93004	PISTON GAS ELEVABLE BCP1 18kgs AL	383
92226	BL RODAMIENTO REGULABLE CORTIZO 5200 RD40 ZN	86	92335	BL BISAGRA COMPAS BCP12 200mm ZN	385	93005	COMPAS ELEVABLE REGULABLE BCP6 NI	384
92227	BL CONTERA RECT ALETAS CNT4 10x40mm NE	376	92336	BL TIRACORDON CORTINA C/AGUJERO CT18 BL	239	93006	BISAGRA COMPAS BCP5 200mm ZN	385
92228	BL RODAMIENTO CO-36 RD32 ZN	85	92337	BL CERRADURA SOBREPONER CM17 22mm LTD	242	93007	BISAGRA COMPAS BCP5 250mm ZN	385
92229	BL RODAMIENTO CO-22 RD33 AL	85	92338	BL CERRADURA EMBUTIR CM15 15mm LP	242	93009	PISTON GAS ABATIBLE BCP3 8kgs AL	383
92230	BL RODAMIENTO CO-22 RD19 BC	84	92339	BL CERRADURA EMBUTIR CM15 20mm LP	242	93010	PISTON GAS ELEV FRIC BCP2 12kgs AL	383
92231	BL JGO RODAMIENTO MAMPARA RD4 GR/BL	89	92340	BL CERRADURA EMBUTIR CM15 25mm LP	242	93011	JGO BISAGRA CANAPE BCP4 710x115mm NE	382
92232	BL RETENEDOR VENTANA CLIP1 NE	129	92341	BL CERRADURA EMBUTIR CM15 30mm LP	242	93012	PISTON GAS CANAPE BCP4 800mm NE	382
92233	BL SOPORTE CERRADO OVAL STA9 30x15mm AL	233	92342	BL CERRADURA EMBUTIR CM15 35mm LP	242	93013	PISTON GAS CANAPE BCP4 1150mm NE	382
92234	BL NIVELADOR PLANO NV7 M6x6mm NE	370	92343	BL CERRADURA EMBUTIR CM15 40mm LP	242	93014	PISTON GAS CANAPE BCP4 1250mm NE	382
92235	BL RODAMIENTO MAMPARA ART RD6 21mm BL	89	92344	BL CERRADURA SOBREPONER CM16 20mm LTD	242	93015	PISTON GAS CANAPE BCP4 1400mm NE	382
92236	BL CILINDRO SEGURIDAD CS4 L15 30x30mm LT	104	92345	BL CERRADURA SOBREPONER CM16 25mm LTD	242	93016	COMPAS PUERTA ELEVABLE DCHA BCP7 NI	384
92237	BL CILINDRO SEGURIDAD CS4 L15 30x30mm NI	104	92346	BL CERRADURA SOBREPONER CM16 30mm LTD	242	93017	COMPAS PUERTA ELEVABLE IZDA BCP7 NI	384
92238	BL CILINDRO SEGURIDAD CS4 L15 35x35mm LT	104	92347	BL CERRADURA SOBREPONER CM16 35mm LTD	242	93018	COMPAS ELEVABLE DCHA BCP8 2,5-4kg GR*	384
92239	BL CILINDRO SEGURIDAD CS4 L15 35x35mm NI	104	92348	BL CERRADURA SOBREPONER CM16 40mm LTD	242	93019	COMPAS ELEVABLE IZDA BCP8 2,5-4kg GR*	384
92240	BL CILINDRO SEGURIDAD CS4 L15 30x40mm LT	104	92349	BL CERRADURA FALLEBA CM18 18,5mm BL	242	93020	COMPAS ELEVABLE DCHA BCP8 4,5-6,5kg GR*	384
92241	BL CILINDRO SEGURIDAD CS4 L15 30x40mm NI	104	92350	BL CERRADURA FALLEBA CM18 18,5mm MA	242	93021	COMPAS ELEVABLE IZDA BCP8 4,5-6,5kg GR*	384
92242	BL CILINDRO SEGURIDAD CS4 L13 30x30mm NI	105	92351	BL CERRADURA MUEBLE HEBILLA CM19 80x32mm CB	243	93022	PISTON GAS ELEVABLE BCP1 18kgs AL	383
92243	BL CILINDRO SEGURIDAD CS4 L13 35x35mm NI	105	92352	BL CERRADURA MUEBLE HEBILLA CM19 94x32mm CB	243	93023	PISTON GAS ELEVABLE BCP1 15kgs AL	383
92244	BL CILINDRO SEGURIDAD CS4 L13 30x40mm NI	105	92353	BL CERRADURA MUEBLE HEBILLA CM19 110x40mm CB	243	93024	PISTON GAS CANAPE BCP4 350mm NE	382
92254	BL CASCABEL LATON CCB1 8mm NI	415	92354	BL PLACA AMARRE REDONDA AP8 33mm AISI316	329	94001	PANTALONERO 8 PERCHAS IA1 CB	224
92255	BL CASCABEL LATON CCB1 11mm NI	415	92355	BL PLACA AMARRE REDONDA AP8 40mm AISI316	329	94002	PANTALONERO 10 PERCHAS IA1 CB	224
92256	BL CASCABEL LATON CCB1 13mm NI	415	92356	BL PLACA AMARRE REDONDA AP8 50mm AISI316	329	94003	PANTALONERO 11 PERCHAS IA2 CB	224
92257	BL CASCABEL LATON CCB1 15mm NI	415	92357	BL PLACA AMARRE REDONDA C/ANILLA AP9 33mm AISI316	329	94009	PERCHERO ABATIBLE IA5 450-600mm AL	226
92258	BL CASCABEL LATON CCB1 17mm NI	415	92358	BL PLACA AMARRE REDONDA C/ANILLA AP9 40mm AISI316	329	94010	PERCHERO ABATIBLE IA5 600-830mm AL	226
92259	BL CASCABEL LATON CCB1 20mm NI	415	92359	BL PLACA AMARRE REDONDA C/ANILLA AP9 50mm AISI316	329	94011	PERCHERO ABATIBLE IA5 830-1150mm AL	226
92260	BL ALDABA REVERSIBLE PEQUEÑA ADB6 IN	130	92360	BL PLACA AMARRE OVAL AP10 45x17mm AISI316	329	94012	ZAPATERO CAJON EXT IA4 400/600mm CB	225
92261	BL ALDABA REVERSIBLE GRANDE ADB6 IN	130	92361	BL PLACA AMARRE OVAL AP10 60x20mm AISI316	329	94013	ZAPATERO CAJON EXT IA4 600/1000mm CB	225
92262	BL CIERRE PRESION PEQUEÑO CP1 IN	130	92362	BL PLACA AMARRE OVAL AP10 80x26mm AISI316	329	94014	ZAPATERO EXT TOTAL IA3 400/600mm CB	224
92263	BL CIERRE PRESION GRANDE CP1 IN	130	92363	BL PLACA AMARRE OVAL C/ANILLA AP11 45x17mm AISI316	329	94015	ZAPATERO EXT TOTAL IA3 600/1000mm CB	224
92264	BL CIERRE PRESION CUADRADO CP2 IN	130	92364	BL PLACA AMARRE OVAL C/ANILLA AP11 60x20mm AISI316	329	94018	SOPORTE PERCHAS EXT IA7 300mm CB	226
92265	BL POLEA TENDER CTUERCA POL7 40mm IN	412	92365	BL PLACA AMARRE OVAL C/ANILLA AP11 80x26mm AISI316	329	94019	SOPORTE PERCHAS EXT IA7 350mm CB	226
92266	BL JGO BISAGRA CRISTAL BSC21 LTD	185	92366	BL DESLIZANTE ATORNILLAR SD DZ6 19mm GR	287	94020	SOPORTE PERCHAS EXT IA7 400mm CB	226
92267	BL JGO BISAGRA CRISTAL BSC21 CB	185	92367	BL DESLIZANTE ATORNILLAR SD DZ6 25mm GR	287	94021	SOPORTE PERCHAS EXT IA7 450mm CB	226
92268	BL JGO BISAGRA CRISTAL BSC21 NE	185	92368	BL DESLIZANTE ATORNILLAR SD DZ6 30mm GR	287	94023	SOPORTE PERCHAS EXT IA7 500mm CB	226
92269	BL JGO BISAGRA CRISTAL BSC21 NS	185	92369	BL DESLIZANTE ATORNILLAR SD DZ6 38mm GR	287	94025	JGO ZAPATERO 2 BALDAS IA6 BL	225
92270	BL PORTAESTANTE VITRINA PEQ PE5 GR	264	92370	BL SEGURO PERSIANA CUÑA DENTADA PR25 IN	393	94026	JGO ZAPATERO 2 BALDAS IA6 MA	225
92271	BL PORTAESTANTE VITRINA GDE PE5 GR	264	92371	BL ALDABA CUÑA ADB7 60mm LS	132	94111	ESTERILLA ANTIDESLIZANTE DZ11 20mts GR	342
92272	BL TORNILLO PRISIONERO MANILLA TRN4 M5x6mm IN	117	92372	BL ALDABA CUÑA ADB7 60mm NS	132	94112	PROTECTOR FONDO FREGADERO PTR1 500x580mm AL	349
92273	BL CERRADURA COMBINACION TAQUILLA CM13 CB	245	92373	BL ALDABA CUÑA ADB7 60mm NE	132	94113	PROTECTOR FONDO FREGADERO PTR1 600x580mm AL	349
92274	BL CERRADURA COMBINACION TAQUILLA CM15 NE	245	92374	BL PORTAESTANTE ARANDELA PE3 3-5x16mm ZN	265	94114	PROTECTOR FONDO FREGADERO PTR1 700x580mm AL	349
92275	BL JGO TIRADOR EMBUTIR MAMPARA BSC8 IN	163	92375	BL ANGULO SUPER AN3 30x30mm ZN	307	94115	PROTECTOR FONDO FREGADERO PTR1 800x580mm AL	349
92276	BL JGO POMO MAMPARA BSC12 CB	163	92376	BL ANGULO SUPER AN3 50x50mm ZN	307	94116	PROTECTOR FONDO FREGADERO PTR1 900x580mm AL	349
92277	BL JGO POMO MAMPARA BSC13 CB	163	92377	BL ANGULO SUPER AN3 75x75mm ZN	307	94117	COPETE CLASSIC CPT1 18kgs AL	344
92278	BL JGO POMO MAMPARA BSC14 CB	163	92378	BL ANGULO SUPER AN3 100x100mm ZN	307	94118	COPETE CLASSIC CPT1 4mts BL	344
92279	BL KIT CONTRACIERRE ZAMAK 6819	65	92379	BL IMAN PETANCA NEODIMIO IM33 NE	257	94119	COPETE CLASSIC CPT1 4mts NE	344
92280	BL KIT CERRADERO LENGÜETA 6818	65	92380	BL CREMONA 2 PATILLAS 6829 ALUM PL	70	94120	RINCON COPETE CLASSIC CPT1 AL	344
92281	BL ASA RECTA S/PLACA 6804 ALUM BL	60	92381	BL NEODIMIO DISCO IM28 5x3mm NI	255	94121	RINCON COPETE CLASSIC CPT1 BL	344
92282	BL ASA RECTA S/PLACA 6804 ALUM NE	60	92382	BL NEODIMIO DISCO IM28 9,5x1,5mm NI	255	94122	RINCON COPETE CLASSIC CPT1 NE	344
92283	BL ASA RECTA S/PLACA 6804 ALUM PL	60	92383	BL NEODIMIO DISCO IM28 10x3mm NI	255	94123	ESQUINA COPETE CLASSIC CPT1 AL	344
92284	BL CERRADERO 40/20 6850 140x31,5mm BL	74	92384	BL NEODIMIO DISCO IM28 14x4mm NI	255	94124	ESQUINA COPETE CLASSIC CPT1 BL	344
92285	BL CERRADERO 40/20 6850 140x31,5mm NE	74	92385	BL NEODIMIO DISCO IM28 20x5mm NI	255	94125	ESQUINA COPETE CLASSIC CPT1 NE	344
92286	BL CERRADERO 40/20 6850 195x31,5mm BL	74	92386	BL NEODIMIO DISCO IM28 22x10mm NI	255	94126	TAPA COPETE CLASSIC DCHA CPT1 AL	344
92287	BL CERRADERO 40/20 6850 195x31,5mm NE	74	92387	BL NEODIMIO DISCO IM28 28x10mm NI	255	94127	TAPA COPETE CLASSIC IZDA CPT1 AL	344
92288	BL CERRADERO EUROPEO 6851 170x22mm BL	74	92388	BL NEODIMIO DISCO ADH IM29 9,5x1,5mm NI	254	94128	TAPA COPETE CLASSIC DCHA CPT1 BL	344
92289	BL CERRADERO EUROPEO 6851 170x22mm NE	74	92389	BL NEODIMIO DISCO ADH IM29 12,5x1,5mm NI	254	94129	TAPA COPETE CLASSIC IZDA CPT1 BL	344
92290	BL CERRADERO EUROPEO 6851 225x22mm BL	74	92390	BL NEODIMIO BLOQUE IM30 20x10x5mm NI	255	94130	CUBERTERO CBT1 300/235x480mm GR	342
92291	BL CERRADERO EUROPEO 6851 225x22mm NE	74	92391	BL NEODIMIO BLOQUE IM30 30x9x2mm NI	255	94131	TAPA COPETE CLASSIC DCHA CPT1 NE	344
92292	BL KIT ABATIBLE 1 HOJA 40/20 6852 NE	74	9239					

NUMÉRICO

Código	Descripción	Pág.	Código	Descripción	Pág.	Código	Descripción	Pág.
94135	CUBERTERO CBT1 350/285x480mm GR	342	94845	ESCURREVASOS ECR4 450mm BL	341	96149	PATA ECO CUADRADA PT24 150x25mm NS	361
94137	RINCON COPETE ROUND CPT2 AL	345	94850	ESCURREVASOS ECR4 500mm BL	341	96150	PATA ECO CUADRADA PT24 200x25mm NS	361
94138	RINCON COPETE ROUND CPT2 BL	345	94860	ESCURREVASOS ECR4 600mm BL	341	96151	PATA ECO CUADRADA PT24 400x25mm NS	361
94140	CUBERTERO CBT1 400/335x480mm GR	342	94870	ESCURREVASOS ECR4 700mm BL	341	96152	PATA ECO CUADRADA PT24 700x25mm NS	361
94141	ESQUINA COPETE ROUND CPT2 AL	345	94880	ESCURREVASOS ECR4 800mm BL	341	96153	PATA ECO CUADRADA PT24 800x25mm NS	361
94142	ESQUINA COPETE ROUND CPT2 BL	345	94890	ESCURREVASOS ECR4 900mm BL	341	96154	BL NIVELADOR PATA ECO NV9 M10x29mm CB	369
94144	TAPA COPETE ROUND CPT2 AL	345	94910	JGO ESCURREPLATO-VASO ECR1 1000mm IN	340	96155	NIVELADOR PATA ECO NV9 M10x29mm CB	369
94145	CUBERTERO CBT1 450/385x480mm GR	342	94940	JGO ESCURREPLATO-VASO ECR1 400mm IN	340	96200	PATA MUEBLE CUADRADA PT16 120x32mm AL	365
94146	TAPA COPETE ROUND CPT2 BL	345	94945	JGO ESCURREPLATO-VASO ECR1 450mm IN	340	96202	PATA MUEBLE REDONDA PT13 140-190mm BL	364
94148	ZOCALO ALUMINIO ZCL1 144x4mts AL	348	94950	JGO ESCURREPLATO-VASO ECR1 500mm IN	340	96203	PATA MUEBLE REDONDA PT14 80-110mm AL	364
94149	BL TAPA ENCIMERA ENC1 650x30mm AL	346	94960	JGO ESCURREPLATO-VASO ECR1 600mm IN	340	96204	PATA MUEBLE REDONDA PT14 100-130mm AL	364
94150	CUBERTERO CBT1 500/435x480mm GR	342	94970	JGO ESCURREPLATO-VASO ECR1 700mm IN	340	96205	PATA MUEBLE REDONDA PT14 120-150mm BL	364
94151	BL TAPA ENCIMERA ENC1 650x30mm BL	346	94980	JGO ESCURREPLATO-VASO ECR1 800mm IN	340	96206	PATA MUEBLE REDONDA PT14 150-170mm AL	364
94152	BL TAPA ENCIMERA ENC1 650x30mm NE	346	94990	JGO ESCURREPLATO-VASO ECR1 900mm IN	340	96207	PATA MUEBLE REDONDA PT15 60x40mm AL	365
94153	BL UNION ENCIMERA ENC2 650x30mm AL	346	95001	SOPORTE TECLADO S/BANDEJA ST01 BL	219	96208	PATA MUEBLE CUADRADA PT15 80x40mm AL	365
94154	BL UNION ENCIMERA ENC2 650x30mm BL	346	95002	SOPORTE TECLADO C/BANDEJA ST01 BL	219	96209	PATA MUEBLE CUADRADA PT15 100x40mm AL	365
94155	BL UNION ENCIMERA ENC2 650x30mm NE	346	95003	JGO GUJA PORTATECLADO GC14 350mm ZN	219	96210	PATA MUEBLE CUADRADA PT15 120x40mm AL	365
94156	BL EXTENSION ENCIMERA ENC3 650x30mm AL	346	95004	TAPON PASACABLES TPC1 60x22mm GR	219	96211	PATA MUEBLE CUADRADA PT15 150x40mm AL	365
94157	BL EXTENSION ENCIMERA ENC3 650x30mm BL	346	95005	TAPON PASACABLES TPC1 60x22mm NE	219	96212	PATA MUEBLE CUADRADA PT15 180x30mm AL	363
94158	BL EXTENSION ENCIMERA ENC3 650x30mm NE	346	95008	TAPON PASACABLES TPC1 60x22mm BE	219	96213	PATA MUEBLE CUADRADA PT1 100x100x20mm AL	363
94159	ZOCALO PVC ZCL2 144x4mts AL	348	95009	TAPON PASACABLES TPC1 60x22mm MA	219	96214	PATA MUEBLE REDONDA PT2 130-190mm NE	366
94160	CUBERTERO CBT1 600/535x480mm GR	342	95010	TAPON PASACABLES TPC1 60x22mm PL	219	96215	PATA MUEBLE REDONDA PT3 130-200mm NE	366
94161	CUBERTERO CBT1 700/635x480mm GR	342	95011	TAPON PASACABLES TPC1 60x22mm BL	219	96216	PATA MUEBLE REDONDA PT4 50-70mm NE	366
94162	CUBERTERO CBT1 800/735x480mm GR	342	95014	TAPON PASACABLES TPC1 80x22mm GR	219	96217	PATA MUEBLE REDONDA PT17 35-50mm NE	367
94163	CUBERTERO CBT1 900/835x480mm GR	342	95015	TAPON PASACABLES TPC1 80x22mm BL	219	96218	PATA MUEBLE REDONDA PT17 45-70mm NE	367
94164	CUBERTERO CBT1 1000/935x480mm GR	342	95018	TAPON PASACABLES TPC1 80x22mm BL	219	96219	PATA MUEBLE REDONDA PT17 65-100mm NE	367
94165	CUBERTERO CBT1 1200/1135x480mm GR	342	95038	JGO BISAGRA ELEVABLE BS26 380mm NE	212	96220	PATA MUEBLE REDONDA PT18 60x40mm AL	364
94170	JGO PROTECTOR CAMPANA PTR2 330mm IN	349	95039	JGO BISAGRA ELEVABLE BS26 380mm GR	212	96221	PATA MUEBLE REDONDA PT18 80x40mm AL	364
94171	JGO PROTECTOR CAMPANA PTR2 330mm BL	349	95040	JGO BISAGRA ELEVABLE BS26 410mm NE	212	96222	PATA MUEBLE REDONDA PT18 100x40mm AL	364
94172	PROTECTOR COSTADO FRIGO PTR3 19mm EI	347	96001	PATA MESA PT6 710x60mm BL	360	96223	PATA MUEBLE REDONDA PT18 120x40mm AL	364
94173	PROTECTOR ZOCALO MADERA PTR7 19mm TR	348	96002	PATA MESA PT6 710x60mm NE	360	96224	PATA MUEBLE REDONDA PT18 150x40mm AL	364
94174	RINCON ZOCALO ALUMINIO ZCL4 144mm AL	348	96003	PATA MESA PT6 710x60mm CB	360	96225	PATA MUEBLE REDONDA PT18 180x40mm AL	364
94175	BL ESTERILLA ANTIDESLIZANTE DZ12 480x1,5mts GR	342	96004	PATA MESA PT6 710x60mm NS	360	96226	PATA MUEBLE REDONDA PT19 120x40mm AL	365
94176	ZOCALO ALUMINIO ZCL3 144mm AL	348	96005	PATA MESA PT6 710x60mm RAL9006	360	96227	PATA MUEBLE CUADRADA PT19 60x40mm AL	365
94182	PROTECTOR COSTADO FRIGO PTR4 19mm IN	347	96006	PATA MESA PT6 710x80mm BL	360	96228	PATA MUEBLE CUADRADA PT19 80x40mm AL	365
94183	PROTECTOR VITROCERAMICA PTR5 605x525mm IN	347	96007	PATA MESA PT6 710x80mm NE	360	96229	PATA MUEBLE CUADRADA PT19 100x40mm AL	365
94184	PROTECTOR GAS PTR5 605x525mm IN	347	96008	PATA MESA PT6 710x80mm CB	360	96230	PATA MUEBLE CUADRADA PT19 120x40mm AL	365
94185	SALVA ENCIMERA PLANO PTR6 470x315mm IN	349	96009	PATA MESA PT6 710x80mm NS	360	96231	PATA MUEBLE CUADRADA PT19 150x40mm AL	365
94186	SALVA ENCIMERA CURVA PTR6 470x315mm IN	349	96010	PATA MESA PT6 710x80mm RAL9006	360	96232	PATA MUEBLE CUADRADA PT19 180x40mm AL	365
94187	PROTECTOR FONDO FREGADERO PTR1 1000x580mm AL	347	96011	PATA MESA PT6 830x60mm BL	360	96233	PATA MUEBLE CUADRADA PT19 200x40mm AL	365
94188	BL TAPA ENCIMERA ENC4 650x40mm AL	346	96012	PATA MESA PT6 830x60mm NE	360	96234	PATA MUEBLE REDONDA PT20 20-30mm NE	367
94189	BL UNION ENCIMERA ENC5 650x40mm AL	346	96013	PATA MESA PT6 830x60mm CB	360	96235	PATA MUEBLE CUADRADA PT21 100x20mm BL	363
94190	BL EXTENSION ENCIMERA ENC6 650x40mm AL	346	96014	PATA MESA PT6 830x60mm NS	360	96236	PATA MUEBLE CUADRADA PT21 100x20mm AL	363
94191	JGO GRAPA SUJECION FREGADERO GRP3 NI	349	96015	PATA MESA PT6 830x60mm RAL9006	360	96237	PATA MUEBLE CUADRADA PT22 120x40x30mm BL	363
94192	JGO GRAPA SUJECION FREGADERO GRP4 NI	349	96016	PATA MESA PLEGABLE PTT 710x50x50mm RAL9006	358	96238	PATA MUEBLE CUADRADA PT22 120x40x30mm AL	363
94193	BURLETE FREGADERO BLT12 GR	349	96017	PATA MESA PLEGABLE PTT 710x50mm RAL9006	358	96239	NIVELADOR PATA PT21 M6 GR	369
94230	CUBERTERO CBT1 300/235x480mm BL	342	96018	PATA MESA PLEG/REG PT9 710x50mm RAL9006	359	96240	NIVELADOR PATA PT22 M8 GR	369
94235	CUBERTERO CBT1 350/285x480mm BL	342	96019	PATA MESA REGULABLE PT10 710x60mm RAL9006	359	96301	PATA MUEBLE REDONDA PT11 130-200mm NE	366
94240	CUBERTERO CBT1 400/335x480mm BL	342	96020	PLACA PATA PT6 M10 NE	360	96302	PATA MUEBLE REDONDA T/PLAST PT12 130-200mm NE	367
94245	CUBERTERO CBT1 450/385x480mm BL	342	96021	PATA MESA PLEGABLE PTT5 710x50mm CB	358	96303	PATA MUEBLE REDONDA TIZAMAK PT12 130-200mm NE	367
94250	CUBERTERO CBT1 500/435x480mm BL	342	96022	PATA MESA PLEGABLE PTT5 710x50mm NS	358	96305	PINZA ZOCALO MADERA/ALUMINIO ZCL5 NE	367
94260	CUBERTERO CBT1 600/535x480mm BL	342	96023	PATA MESA PT6 1200x60mm NS	360	96306	PINZA ZOCALO PVC/ALUMINIO ZCL6 NE	367
94360	JGO ESCURREPLATO-VASO ECR2 600mm CB	340	96101	PATA MESA PT6 870x60mm BL	360	96400	JGO 4 PATAS SOMIER PT25 250x30x30mm S/R NE	362
94370	JGO ESCURREPLATO-VASO ECR2 700mm CB	340	96102	PATA MESA PT6 870x60mm NE	360	96401	JGO 4 PATAS SOMIER PT25 250x30x30mm C/R NE	362
94380	JGO ESCURREPLATO-VASO ECR2 800mm CB	340	96103	PATA MESA PT6 870x60mm CB	360	96402	JGO 4 PATAS SOMIER PT25 250x35x35mm S/R NE	362
94390	JGO ESCURREPLATO-VASO ECR2 900mm CB	340	96104	PATA MESA PT6 870x60mm NS	360	96403	JGO 4 PATAS SOMIER PT25 250x35x35mm C/R NE	362
94400	REGLETA ESCURREPLATO ECR6 BL	341	96105	PATA MESA PT6 870x60mm RAL9006	360	96404	JGO 4 PATAS SOMIER PT25 250x30x40mm S/R NE	362
94401	PIVOTE ESCURREPLATO ECR6 BL	341	96106	PATA ECO REDONDA PT23 100x30mm BL	361	96405	JGO 4 PATAS SOMIER PT25 250x30x40mm C/R NE	362
94402	ESCURREPLATOS ACOPLABLE ECR5 250mm BL	340	96107	PATA ECO REDONDA PT23 150x30mm BL	361	96406	JGO 4 PATAS CANAPE PT26 270x50mm S/R NE	362
94403	ESCURREPLATOS ACOPLABLE ECR5 250mm CB	340	96108	PATA ECO REDONDA PT23 250x30mm BL	361	96407	JGO 4 PATAS SOMIER PT25 250x30x30mm S/R GR	362
94404	BANDEJA VIERTEAGUAS ECR7 450mm BL	341	96109	PATA ECO REDONDA PT23 400x30mm BL	361	96408	JGO 4 PATAS SOMIER PT25 250x30x30mm C/R GR	362
94405	BANDEJA VIERTEAGUAS ECR7 500mm BL	341	96110	PATA ECO REDONDA PT23 700x30mm BL	361	96409	JGO 4 PATAS SOMIER PT25 250x35x35mm S/R GR	362
94406	BANDEJA VIERTEAGUAS ECR7 600mm BL	341	96111	PATA ECO REDONDA PT23 800x30mm BL	361	96410	JGO 4 PATAS SOMIER PT25 250x35x35mm C/R GR	362
94407	BANDEJA VIERTEAGUAS ECR7 700mm BL	341	96112	PATA ECO REDONDA PT23 100x30mm GR	361	96411	JGO 4 PATAS SOMIER PT25 250x30x40mm S/R GR	362
94408	BANDEJA VIERTEAGUAS ECR7 800mm BL	341	96113	PATA ECO REDONDA PT23 150x30mm GR	361	96412	JGO 4 PATAS SOMIER PT25 250x30x40mm C/R GR	362
94409	BANDEJA VIERTEAGUAS ECR7 900mm BL	341	96114	PATA ECO REDONDA PT23 250x30mm GR	361	96413	JGO 4 PATAS CANAPE PT26 270x50mm S/R GR	362
94410	JGO ESCURREPLATO-VASO ECR2 1000mm BL	340	96115	PATA ECO REDONDA PT23 400x30mm GR	361	96414	SOPORTE SOMIER SMR1 57x50mm ZN	293
94440	JGO ESCURREPLATO-VASO ECR2 400mm BL	340	96116	PATA ECO REDONDA PT23 700x30mm GR	361	96415	JGO ENGANCHE CAMA SMR3 95x23mm ZN	292
94445	JGO ESCURREPLATO-VASO ECR2 450mm BL	340	96117	PATA ECO REDONDA PT23 800x30mm GR	361	96417	JGO 4 PATAS CANAPE PT26 270x50mm C/R NE	362
94450	JGO ESCURREPLATO-VASO ECR2 500mm BL	340	96118	PATA ECO REDONDA PT23 100x30mm NE	361	96418	JGO 4 PATAS CANAPE PT25 250x50mm C/R GR	362
94460	JGO ESCURREPLATO-VASO ECR2 600mm BL	340	96119	PATA ECO REDONDA PT23 150x30mm NE	361	96419	ESCUADRA BAÑERA CAMA SMR5 310x76mm GV	293
94470	JGO ESCURREPLATO-VASO ECR2 700mm BL	340	96120	PATA ECO REDONDA PT23 250x30mm NE	361	96420	SOPORTE LARGUERO CAMA SMR2 40mm ZN	293
94480	JGO ESCURREPLATO-VASO ECR2 800mm BL	340	96121	PATA ECO REDONDA PT23 400x30mm NE	361	96421	SOPORTE LARGUERO CAMA SMR2 50mm ZN	293
94490	JGO ESCURREPLATO-VASO ECR2 900mm BL	340	96122	PATA ECO REDONDA PT23 700x30mm NE	361	96422	SOPORTE ESCALERA LITERA SMR6 71x20mm ZN	293
94505	MARCO MICROONDAS MCR1 600x400mm BL	343	96123	PATA ECO REDONDA PT23 800x30mm NE	361	96423	ENGANCHE LARGUERO CAMA SMR4 80mm ZN	292
94506	MARCO MICROONDAS MCR1 600x400mm IN	343	96124	PATA ECO REDONDA PT23 100x30mm NS	361	96426	PATA CANAPE PT27 55x50mm NE	362
94507	MARCO MICROONDAS MCR1 600x400mm NE	343	96125	PATA ECO REDONDA PT23 150x30mm NS	361	96427	JGO 4 PATAS SOMIER PT25 300x30x30mm S/R NE	362
94508	MARCO MICROONDAS MCR1 600x400mm EI	343	96126	PATA ECO REDONDA PT23 250x30mm NS	361	96428	JGO 4 PATAS SOMIER PT25 300x30x30mm C/R NE	362
94511	BL REJILLA FRIGO-HORNO 8 ELEM RJV1 BL	343	96127	PATA ECO REDONDA PT23 400x30mm NS	361	96429	JGO 4 PATAS SOMIER PT25 300x35x35mm S/R NE	362
94512	BL REJILLA FRIGO-HORNO 8 ELEM RJV1 EI	343	96128	PATA ECO REDONDA PT23 700x30mm NS	361	96430	JGO 4 PATAS SOMIER PT25 300x35x35mm C/R NE	362
94513	BL REJILLA FRIGO-HORNO 8 ELEM RJV1 NE	343	96129	PATA ECO REDONDA PT23 800x30mm NS	361	96431	JGO 4 PATAS SOMIER PT25 350x30x30mm S/R NE	362
94514	BL REJILLA FRIGO-HORNO 8 ELEM RJV1 IN	343	96130	PATA ECO CUADRADA PT24 100x25mm BL	361	96432	JGO 4 PATAS SOMIER PT25 350x30x30mm C/R NE	362
94560	ESCURREPLATOS ECR3 600mm CB	341	96131	PATA ECO CUADRADA PT24 150x25mm BL	361	96433	JGO 4 PATAS SOMIER PT25 350x35x35mm S/R NE	362
94570	ESCURREPLATOS ECR3 700mm CB	341	96132	PATA ECO CUADRADA PT24 250x25mm BL	361	96434	JGO 4 PATAS SOMIER PT25 350x35x35mm C/R NE	362
94580	ESCURREPLATOS ECR3 800mm CB	341	96133	PATA ECO CUADRADA PT24 400x25mm BL	361	96701	NIVELADOR REGULABLE NV12 50x19mm NE	368
94590	ESCURREPLATOS ECR3 900mm CB	341	96134	PATA ECO CUADRADA PT24 700x25mm BL	361	96702	NIVELADOR REGULABLE NV13 50x28mm NE	368
94610	ESCURREPLATOS ECR3 1000mm BL	341	96135	PATA ECO CUADRADA PT24 800x25mm BL	361	96703	NIVELADOR PLANO NV5 M6x32mm NE	371
94640	ESCURREPLATOS ECR3 400mm BL	341	96136	PATA ECO CUADRADA PT24 100x25mm GR	361	96704	NIVELADOR PLANO NV6 M8x38mm NE	371
94645	ESCURREPLATOS ECR3 450mm BL	341	96137	PATA ECO CUADRADA PT24 150x25mm GR	361	96705	NIVELADOR PLANO NV6 M10x47mm NE	371
94650	ESCURREPLATOS ECR3 500mm BL	341	96138	PATA ECO CUADRADA PT24 250x25mm GR	361	96706	NIVELADOR POMO NV8 M6x27mm NE	370
94660	ESCURREPLATOS ECR3 600mm BL	341	96139	PATA ECO CUADRADA PT24 400x25mm GR	361	96707	NIVELADOR POMO NV8 M8x38mm NE	370
94670	ESCURREPLATOS ECR3 700mm BL	341	96140	PATA ECO CUADRADA PT24 700x25mm GR	361	96708	NIVELADOR POMO NV8 M10x40mm NE	370
94680	ESCURREPLATOS ECR3 800mm BL	341	96141	PATA ECO CUADRADA PT24 800x25mm GR	361	96709	NIVELADOR TOP NV10 60x30mm GR	368
94690	ESCURREPLATOS ECR3 900mm BL	341	96142	PATA ECO CUADRADA PT24 100x25mm NE	361	96711	TAPA NIVELADOR PLANO NV5 40mm CB	371
94760	ESCURREVASOS ECR4 600mm CB	341	96143	PATA ECO CUADRADA PT24 150x25mm NE	361	96712	TAPA NIVELADOR PLANO NV6 40mm CB	371
94770	ESCURREVASOS ECR4 700mm CB	341	96144	PATA ECO CUADRADA PT24 250x25mm NE	361	96713	NIVELADOR REGULABLE NV1 0-12mm NE	369
94780	ESCURREVASOS ECR4 800mm CB	341	96145	PATA ECO CUADRADA PT24 40				

NUMÉRICO

Código	Descripción	Pág.	Código	Descripción	Pág.	Código	Descripción	Pág.
96718	NIVELADOR PLANO NV4 M10x44mm NE	370	97166	TAPAJUNTAS PLANO TORN TJ2 1000mm OR	122	97832	PLACA BOCALLAVE PLP2 80x60mm LS	100
96719	NIVELADOR REGULABLE NV3 M6x17mm BL	369	97167	TAPAJUNTAS PLANO TORN TJ2 1000mm PL	122	97833	PLACA BOCALLAVE PLP2 80x60mm NS	100
96720	NIVELADOR PLANO NV7 M6x6mm NE	370	97168	TAPAJUNTAS PLANO TORN TJ6 1000mm LTD	123	97834	PLACA CIEGA PLP3 600x250mm IN	99
97035	MEDULA REJILLA VEGETAL RV2 3.5mm	414	97169	TAPAJUNTAS PLANO TORN TJ6 1000mm IN	123	97835	PLACA CIEGA PLP3 700x250mm IN	99
97046	REJILLA VEGETAL RV1 46cmx15mts	414	97170	TAPAJUNTAS ESCALON ADH TJ3 830mm OR	122	97836	PLACA CIEGA PLP3 800x250mm IN	99
97051	REJILLA VEGETAL RV1 51cmx15mts	414	97171	TAPAJUNTAS ESCALON ADH TJ3 830mm PL	122	97837	PLACA CIEGA PLP3 900x250mm IN	99
97061	REJILLA VEGETAL RV1 61cmx15mts	414	97172	TAPAJUNTAS ESCALON ADH TJ7 830mm LTD	123	97838	PLACA CIEGA PLP3 1000x250mm IN	99
97073	BURLETE EMBUTIR ALUM BLT9 625-725mm PL	120	97173	TAPAJUNTAS ESCALON ADH TJ7 830mm IN	123	97839	PLACA CIEGA PLP3 1200x250mm IN	99
97074	BURLETE BASCULANTE BLT10 625-825mm PL	120	97174	TAPAJUNTAS ESCALON ADH TJ3 1000mm OR	122	97842	PLACA PISA PUERTA PLP4 147x98mm LS	100
97075	BURLETE BASCULANTE BLT10 625-825mm BL	120	97175	TAPAJUNTAS ESCALON ADH TJ3 1000mm PL	122	97843	PLACA PISA PUERTA PLP5 147x98mm LS	100
97076	REJILLA VEGETAL RV1 76cmx15mts	414	97176	TAPAJUNTAS ESCALON ADH TJ7 1000mm LTD	123	97844	PLACA PISA PUERTA PLP5 147x98mm IN	100
97077	BURLETE BASCULANTE BLT10 625-825mm BR	120	97177	TAPAJUNTAS ESCALON ADH TJ7 1000mm IN	123	97845	PLACA PISA PUERTA PLP5 147x98mm NE	100
97078	BURLETE GARAJE FLECOS BLT8 2500mm BL	121	97178	TAPAJUNTAS ESCALON TORN TJ4 830mm OR	122	97911	BOCALLAVE PERA 707 50mm LTD	49
97079	BURLETE GARAJE FLECOS BLT8 2500mm PL	121	97179	TAPAJUNTAS ESCALON TORN TJ4 830mm PL	122	97912	BOCALLAVE PERA 707 50mm LS	49
97080	BURLETE GARAJE FLECOS BLT8 2500mm NE	121	97180	TAPAJUNTAS ESCALON TORN TJ8 830mm LTD	123	97915	BOCALLAVE PERA 787 50mm CU	49
97081	BURLETE GARAJE FLECOS BLT8 3050mm BL	121	97181	TAPAJUNTAS ESCALON TORN TJ8 830mm IN	123	97916	BOCALLAVE PERA 707 50mm NS	49
97082	BURLETE GARAJE FLECOS BLT8 3050mm PL	121	97182	TAPAJUNTAS ESCALON TORN TJ4 1000mm OR	122	97917	BOCALLAVE PERA 787 50mm LE	49
97083	BURLETE EMBUTIR ALUM BLT9 725-825mm PL	120	97183	TAPAJUNTAS ESCALON TORN TJ4 1000mm PL	122	97919	BOCALLAVE PERA 787 50mm PE	49
97084	BURLETE GARAJE FLECOS BLT8 3050mm NE	121	97184	TAPAJUNTAS ESCALON TORN TJ8 1000mm LTD	123	97920	BOCALLAVE PERA 545 54mm IN	48
97092	REJILLA VEGETAL RV1 92cmx15mts	414	97185	TAPAJUNTAS ESCALON TORN TJ8 1000mm IN	123	97921	BOCALLAVE PERA 575 53mm PVD	48
97093	BURLETE EMBUTIR ALUM BLT9 825-925mm PL	120	97186	BURLETE AUTOMATIC BLT11 820mm BL	120	97922	BOCALLAVE PERA 575 53mm NE	48
97103	BURLETE EMBUTIR ALUM BLT9 925-1025mm PL	120	97187	BURLETE AUTOMATIC BLT11 920mm BL	120	97923	BOCALLAVE PERA 575 53mm BL	48
97120	BURLETE EMBUTIR ALUM BLT9 1025-1125mm PL	120	97188	BURLETE AUTOMATIC BLT11 1020mm BL	120	97924	BOCALLAVE PERA CUADRADO 131 53x53mm IN	49
97121	BURLETE ADHESIVO FLECO BLT4 920mm PL	119	97189	BURLETE AUTOMATIC BLT11 820mm PL	120	97925	BOCALLAVE PERA 898 50mm NM	48
97122	BURLETE ADHESIVO FLECO BLT4 920mm BL	119	97190	BURLETE AUTOMATIC BLT11 920mm PL	120	97926	BOCALLAVE PERA 898 50mm NN	48
97123	BURLETE ADHESIVO FLECO BLT4 920mm SAPELI	119	97191	BURLETE AUTOMATIC BLT11 1020mm PL	120	97927	BOCALLAVE PERA 949 50mm CB	49
97124	BURLETE ADHESIVO FLECO BLT4 920mm RB	119	97192	BURLETE GARAJE LABIO ALUM BLT7 3050mm BL	121	97928	BOCALLAVE PERA CUADRADO 848 50x50mm NM	48
97125	BURLETE ADHESIVO FLECO BLT4 920mm NE	119	97193	BURLETE GARAJE LABIO ALUM BLT7 3050mm PL	121	97929	BOCALLAVE PERA CUADRADO 848 50x50mm NN	48
97126	BURLETE ADHESIVO LABIO BLT5 1050mm PL	119	97194	BURLETE GARAJE LABIO ALUM BLT7 3050mm NE	121	97931	ESCUDO SEGURIDAD PERA ES2 60mm LS	101
97127	BURLETE ADHESIVO LABIO BLT5 1050mm RB	119	97195	TAPAJUNTAS PLANO ADH TJ1 2500mm OR	122	97932	ESCUDO SEGURIDAD PERA ES2 60mm NS	101
97128	BURLETE ADHESIVO LABIO BLT5 1050mm SAPELI	119	97196	TAPAJUNTAS PLANO ADH TJ1 2500mm PL	122	97941	ESCUDO SEGURIDAD ES1 63mm LS	101
97129	BURLETE ADHESIVO LABIO BLT5 1050mm BL	119	97197	PERFIL PELDAÑO ESCALERA ADH TJ9 2000mm OR	121	97942	ESCUDO SEGURIDAD ES1 63mm NS	101
97130	BURLETE BASCULANTE ALUM BLT6 930mm BL	120	97198	PERFIL PELDAÑO ESCALERA ADH TJ9 2000mm PL	121	97943	ESCUDO SEGURIDAD ES3 65mm LS	101
97132	BURLETE BASCULANTE ALUM BLT6 930mm MA	120	97801	PLACA CIEGA PLP1 80x80mm LP	99	97944	ESCUDO SEGURIDAD ES3 65mm NS	101
97134	BURLETE ADHESIVO PVC BLT1 935mm BL	119	97802	PLACA CIEGA PLP1 80x80mm LS	99	98498	ANILLA PILLAVE LV3 SURTIDO	414
97136	BURLETE ADHESIVO PVC BLT1 935mm RB	119	97803	PLACA CIEGA PLP1 80x80mm NS	99	98499	CAJA ANILLAS P/LAVES LLV2 (200 UNID)	414
97137	BURLETE ADHESIVO PVC BLT1 935mm SAPELI	119	97804	PLACA CIEGA PLP1 100x70mm LP	99	98500	CAJA LLAVERO PORTAETIQUETAS PTQ1 (200 UNID)	413
97138	BURLETE ADHESIVO PVC BLT1 1000mm TR	119	97805	PLACA CIEGA PLP1 100x70mm LS	99	98501	LLAVERO PORTAETIQUETAS PTQ2 BLANCO	413
97139	BURLETE BASCULANTE MADERA BLT2 815mm BL	121	97806	PLACA CIEGA PLP1 100x70mm NS	99	98502	LLAVERO PORTAETIQUETAS PTQ2 NEGRO	413
97140	BURLETE BASCULANTE MADERA BLT2 915mm BL	121	97807	PLACA CIEGA PLP1 250x90mm LP	99	98503	LLAVERO PORTAETIQUETAS PTQ2 SURTIDO	413
97142	BURLETE BASCULANTE MADERA BLT2 815mm PINO	121	97808	PLACA CIEGA PLP1 250x90mm LS	99	98504	LLAVERO PORTAETIQUETAS PTQ2 AMARILLO	413
97143	BURLETE BASCULANTE MADERA BLT2 815mm RB	121	97809	PLACA CIEGA PLP1 250x90mm NS	99	98505	LLAVERO PORTAETIQUETAS PTQ2 ROJO	413
97144	BURLETE BASCULANTE MADERA BLT2 915mm RB	121	97810	PLACA BOCALLAVE PLP2 80x80mm LP	100	98506	LLAVERO PORTAETIQUETAS PTQ2 AZUL	413
97145	BURLETE BASCULANTE MADERA BLT2 815mm SAPELI	121	97811	PLACA BOCALLAVE PLP2 80x80mm LS	100	98507	LLAVERO PORTAETIQUETAS PTQ2 NARANJA	413
97146	BURLETE BASCULANTE MADERA BLT2 915mm SAPELI	121	97812	PLACA BOCALLAVE PLP2 80x80mm NS	100	98508	LLAVERO PORTAETIQUETAS PTQ2 VERDE	413
97147	BURLETE ADHESIVO MADERA BLT3 915mm BL	119	97813	PLACA BOCALLAVE PLP2 100x70mm LP	100	98509	LLAVERO PORTAETIQUETAS PTQ2 GRIS	413
97148	BURLETE ADHESIVO MADERA BLT3 915mm PINO	119	97814	PLACA BOCALLAVE PLP2 100x70mm LS	100	98510	PORTAETIQUETAS PTQ3 64x34mm LP	144
97149	BURLETE ADHESIVO MADERA BLT3 915mm RB	119	97815	PLACA BOCALLAVE PLP2 100x70mm NS	100	98511	PORTAETIQUETAS PTQ3 85x44mm LP	144
97150	BURLETE ADHESIVO MADERA BLT3 915mm SAPELI	119	97816	PLACA CIEGA PLP1 60x35mm LP	99	98512	PORTAETIQUETAS PTQ3 64x34mm NI	144
97151	BURLETE GARAJE LABIO ALUM BLT7 2500mm BL	121	97817	PLACA CIEGA PLP1 60x35mm LS	99	98513	PORTAETIQUETAS PTQ3 85x44mm NI	144
97152	BURLETE GARAJE LABIO ALUM BLT7 2500mm PL	121	97818	PLACA CIEGA PLP1 60x35mm NS	99	98514	PORTAETIQUETAS PTQ4 55x28mm LP	144
97153	BURLETE GARAJE LABIO ALUM BLT7 2500mm NE	121	97819	PLACA CIEGA PLP1 60x60mm LP	99	98515	PORTAETIQUETAS PTQ4 77x31mm LP	144
97154	TAPAJUNTAS PLANO ADH TJ1 830mm OR	122	97820	PLACA CIEGA PLP1 60x60mm LS	99	98516	PORTAETIQUETAS PTQ4 102x58 LP	144
97155	TAPAJUNTAS PLANO ADH TJ1 830mm PL	122	97821	PLACA CIEGA PLP1 60x60mm NS	99	98517	PORTAETIQUETAS PTQ4 55x28mm NI	144
97156	TAPAJUNTAS TJS PLANO ADH 830mm LTD	123	97822	PLACA CIEGA PLP1 80x60mm LP	99	98518	PORTAETIQUETAS PTQ4 77x31mm NI	144
97157	TAPAJUNTAS TJS PLANO ADH 830mm IN	123	97823	PLACA CIEGA PLP1 80x60mm LS	99	98519	PORTAETIQUETAS PTQ4 102x58 NI	144
97158	TAPAJUNTAS PLANO ADH TJ1 1000mm OR	122	97824	PLACA CIEGA PLP1 80x60mm NS	99	98616	LLAVERO ANILLA LLV1 16mm NI	413
97159	TAPAJUNTAS PLANO ADH TJ1 1000mm PL	122	97825	PLACA BOCALLAVE PLP2 60x35mm LP	100	98618	LLAVERO ANILLA LLV1 18mm NI	413
97160	TAPAJUNTAS TJS PLANO ADH 1000mm LTD	123	97826	PLACA BOCALLAVE PLP2 60x35mm LS	100	98620	LLAVERO ANILLA LLV1 20mm NI	413
97161	TAPAJUNTAS TJS PLANO ADH 1000mm IN	123	97827	PLACA BOCALLAVE PLP2 60x35mm NS	100	98625	LLAVERO ANILLA LLV1 25mm NI	413
97162	TAPAJUNTAS PLANO TORN TJ2 830mm OR	122	97828	PLACA BOCALLAVE PLP2 60x60mm LP	100	98630	LLAVERO ANILLA LLV1 30mm NI	413
97163	TAPAJUNTAS PLANO TORN TJ2 830mm PL	122	97829	PLACA BOCALLAVE PLP2 60x60mm LS	100	98635	LLAVERO ANILLA LLV1 35mm NI	413
97164	TAPAJUNTAS PLANO TORN TJ6 830mm LTD	123	97830	PLACA BOCALLAVE PLP2 60x60mm NS	100	98936	MANILLON ROSETA 989 NS	33
97165	TAPAJUNTAS PLANO TORN TJ6 830mm IN	123	97831	PLACA BOCALLAVE PLP2 80x60mm LP	100			



CONDICIONES DE VENTA

Portes:

MADRID	100 € neto
PENÍNSULA	250 € neto
BALEARES	300 € neto
CANARIAS	600 € neto
CEUTA Y MELILLA	1.800 € neto

(Despacho e impuestos no incluidos)

Los pedidos inferiores al importe arriba indicado, irán con portes debidos o cargados en factura.

Incidencias:

No se admitirá ninguna reclamación en el plazo de 24 horas posteriores a la recepción de la mercancía y siempre que quede la anomalía sufrida reflejada en el albarán de la agencia.

Al recibir la mercancía aconsejamos revisen bien los bultos y confirmen que no hay anomalías, pérdidas o roturas.

Recomendamos indiquen en el albarán "Pendiente de revisar".

Troqueles:

Los troqueles que se realicen sobre las manillas tendrán un coste neto de 0,90 € por unidad taladrada y no se admitirá devolución.

Productos y precios:

MICEL podrá, sin previo aviso, realizar modificaciones en los productos o en los precios.

Precios válidos desde Julio de 2020 hasta nueva publicación, salvo error tipográfico.

Todos los precios que aparecen en esta publicación no incluyen IVA.

Devoluciones de mercancía:

No se aceptará ninguna reclamación ni devolución de mercancía sin la comunicación previa y aceptación por parte de MICEL.

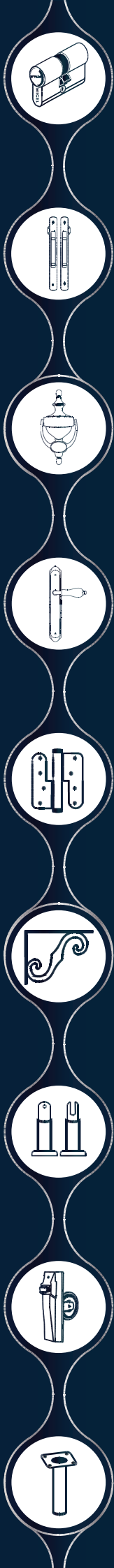

MICEL®

soluciones en herrajes

🏠 San Eustaquio, 4 - Nave 6 - 28021 Madrid

☎ 917 953 026

📞 692 984 362

✉ info@micel.es

🌐 www.micel.es

