





LLAMADOR INGLÉS LLM1



	Código	8431488	Medida AxB	Acabado				€uros
Caja	10018	100180	200X90 mm	LP	-	1	20	
	10182	101828	200X90 mm	NS	-	1	20	
	11181	111810	200X90 mm	NE	-	1	20	
Blister	90650	906508	200x90 mm	LP	1	-	10	
	90652	906522	200x90 mm	NS	1	-	10	
	90654	906546	200x90 mm	NE	1	-	10	

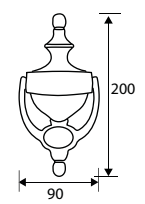

Latón

LATÓN PULIDO
 NÍQUEL SATINADO
 NEGRO

POMO PUERTA OCTOGONAL PP3



	Código	8431488	Medida	Acabado				€uros
Caja	10011	100111	65 mm	LP	-	1	48	

Separado placa y pomo

Latón - M8

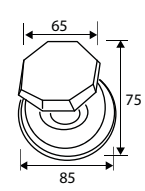

LATÓN PULIDO

POMO PUERTA AROS PP1



	Código	8431488	Medida	Acabado				€uros
Caja	10008	100081	70 mm	LP	-	1	48	
	10002	100029	70 mm	NS	-	1	48	

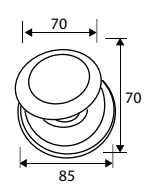

Placa y pomo unidos

Latón - M8



LATÓN PULIDO
 NÍQUEL SATINADO

POMO PUERTA LISO PP2

	Código	8431488	Medida	Acabado				€uros
Caja	10009	100098	70 mm	LP	-	1	48	
	10239	100920	70 mm	NS	-	1	48	
	10240	100937	70 mm	CU	-	1	48	
	11092	110929	70 mm	NE	-	1	48	
	11904	119045	70 mm	INOX	-	1	24	

10009-10239-10240-11092: Latón - M8
11904: Acero Inoxidable - M8

Placa y pomo unidos

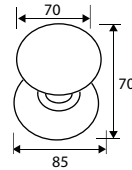

POMO PUERTA BOLA PP5

	Código	8431488	Medida	Acabado				€uros
Caja	10003	100036	60 mm	INOX	-	1	24	
	10001	100012	70 mm	INOX	-	1	24	

Acero Inoxidable - M8

Placa y pomo unidos

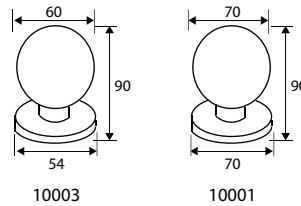

POMO PUERTA BOLA PP4



	Código	8431488	Medida	Acabado				€uros
Caja	10010	100104	75 mm	LP	-	1	24	
	10249	101057	75 mm	NS	-	1	24	

Latón - M8

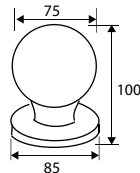
Placa y pomo unidos



POMO PUERTA MARGARITA PP6

	Código	8431488	Medida	Acabado				€uros
Caja	10200	102009	75 mm	LP	-	1	24	
	10110	101101	75 mm	CU	-	1	24	

Latón - M8

Placa y pomo unidos

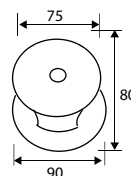



MANILLÓN TORNEADO MN4

Código	8431488	Tipo	Acabado				€uros
10006	100067	300 mm	LP	-	1	-	
10620	106205	300 mm	NS	-	1	-	
10630	106304	300 mm	NE	-	1	-	
10007	100074	400 mm	LP	-	1	-	

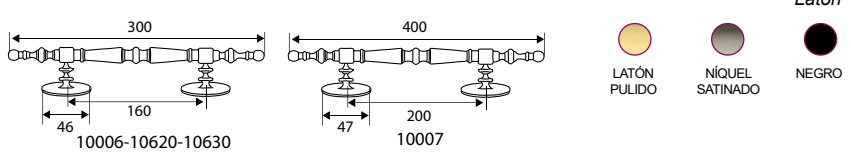

MANILLÓN TORNEADO MN7

Código	8431488	Tipo	Acabado				€uros
10169	101699	300 mm	LP	-	1	-	



MANILLÓN DESPLAZADO MN8

Código	8431488	Tipo	Acabado				€uros
10178	101781	300 mm	LP	-	1	-	



MANILLÓN TORNEADO EXTENSIBLE MN5

Código	8431488	Tipo A	Acabado				€uros
10162	101620	140 - 230 mm	LP	-	1	-	
10179	101798	230 - 300 mm	LP	-	1	-	



MANILLÓN DESPLAZADO EXTENSIBLE MN6

Código	8431488	Tipo - A	Acabado				€uros
10163	101637	140 - 230 mm	LP	-	1	-	
10180	101804	230 - 300 mm	LP	-	1	-	



JGO MANILLÓN RECTO MN3

	Código	8431488	Medida AxBxC	Acabado			€uros
Caja	42300	423005	300x450x30 mm	INOX	-	1 10	
	42350	423500	350x500x30 mm	INOX	-	1 10	
	42450	424507	450x600x30 mm	INOX	-	1 10	
	42600	426006	600x750x30 mm	INOX	-	1 10	
	42900	429007	900x1050x30 mm	INOX	-	1 10	

Acero Inoxidable

Se unen con espárrago roscado al manillón sujeto mediante un prisionero

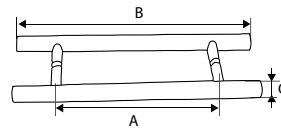

JGO MANILLÓN RECTO MN2

	Código	8431488	Medida AxBxC	Acabado			€uros
Caja	41250	412504	250x275x25 mm	INOX	-	1 -	
	41300	413006	300x325x25 mm	INOX	-	1 -	
	41425	414256	425x450x25 mm	INOX	-	1 -	

Acero Inoxidable

Se unen con espárrago roscado al manillón sujeto mediante un prisionero

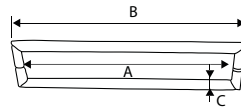

JGO MANILLÓN CURVA MN1

	Código	8431488	Medida AxBxC	Acabado			€uros
Caja	40250	402505	250x270x25 mm	INOX	-	1 10	
	40300	403007	300x325x25 mm	INOX	-	1 10	

Acero Inoxidable

Se unen con espárrago roscado al manillón sujeto mediante un prisionero

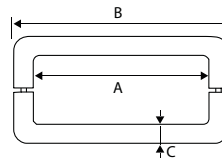

JGO MANILLÓN HUESO MN9

	Código	8431488	Medida	Acabado			€uros
Caja	02131	021317	200 mm	LTD	-	1 20	
	02132	021324	200 mm	LS	-	1 20	
	02133	021331	200 mm	NS	-	1 20	
	02134	021348	200 mm	CU	-	1 20	
	02135	021355	200 mm	CB	-	1 20	
	02136	021362	200 mm	NE	-	1 20	

Zamak

Se puede usar como juego o individual

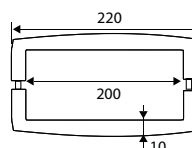



JGO OJO DE BUEY OB1

	Código	8431488	Medida	Acabado				€uros
Caja	54535	545356	380 mm	INOX	-	1	5	

Acero Inoxidable



INOX



No incluye cristal



28

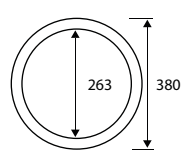

MIRILLA 180° - ø 14 MM MR1

	Código	8431488	Medida A	Acabado				€uros
	10131	101316	15/25 mm	LTD	-	12	300	
	10132	101323	25/42 mm	LTD	-	12	300	
	10013	100135	35/60 mm	LTD	-	12	300	
	10138	101385	60/100 mm	LTD	-	12	300	
	10139	101392	15/25 mm	NS	-	12	300	
	10136	101361	25/42 mm	NS	-	12	300	
	10134	101347	35/60 mm	NS	-	12	300	
	10130	101309	60/100 mm	NS	-	12	300	
	10137	101378	35/60 mm	CU	-	12	300	
<i>Blister</i>	90101	901015	25/42 mm	LTD	1	-	10	
	90103	901039	35/60 mm	LTD	1	-	10	
	90108	901084	25/42 mm	NS	1	-	10	
	90110	901107	35/60 mm	NS	1	-	10	
	90106	901060	35/60 mm	CU	1	-	10	

Presentación en caja individual

Zamak



LATONADO

NIQUEL SATINADO

CUERO

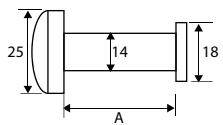

MIRILLA 180° - ø 16 MM MR2

	Código	8431488	Medida	Acabado				€uros
	10165	101651	35/60 mm	LTD	-	12	300	
	10166	101668	35/60 mm	NS	-	12	300	
<i>Blister</i>	91880	918808	35/60 mm	LTD	1	-	10	
	91881	918815	35/60 mm	NS	1	-	10	

Presentación en caja individual

Zamak



LATONADO

NIQUEL SATINADO

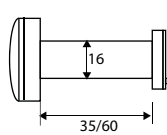

EMBELLECEDOR MIRILLA MR3

	Código	8431488	Medida	Acabado				€uros
Caja	10012	100128	45 mm	LP	-	10	250	
	10242	101224	45 mm	NS	-	10	250	
	10123	101231	45 mm	CU	-	1	10	
	10124	101248	45 mm	NE	-	1	10	

Latón

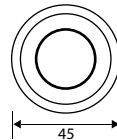

MIRILLA 180° MR1- ø 14 MM + EMBELLECEDOR MR3

	Código	8431488	Medida	Acabado				€uros
Blister	90102	901022	35/60 mm	LTD	1	-	10	
	90109	901091	35/60 mm	NS	1	-	10	

Mirilla: Zamak
Embellecedor: Latón



MIRILLA DIGITAL MD1

	Código	8431488	Medida	Acabado				€uros
Blister	10167	101675	115x62 mm	OR	1	-	32	
	10168	101682	115x62 mm	PL	1	-	32	

Acero / ABS

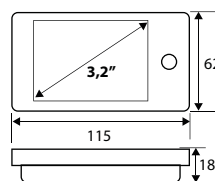

Presentación en caja con colgador

Pantalla de 3,2 pulgadas
Ángulo de visión 160°
Sensor de 1,3 Mega Píxeles
Espesor puerta 42 a 72 mm
Alimentación 3 pilas AAA (no incluidas)





CLAVO REDONDO CL1

	Código	8431488	Medida AxB	Acabado				€uros
Caja	11725	117256	25x30 mm	NE	-	25	250	
	11701	117010	30x30 mm	NE	-	25	250	
	11726	117263	35x30 mm	NE	-	25	250	
	11702	117027	40x30 mm	NE	-	25	250	

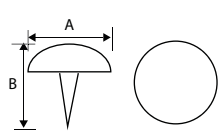

Acero
●
NEGRO



CLAVO GOLF CL2

	Código	8431488	Medida AxB	Acabado				€uros
Caja	11727	117270	25x30 mm	NE	-	25	250	
	11728	117287	30x30 mm	NE	-	25	250	
	11735	117355	35x30 mm	NE	-	25	250	
	11736	117362	40x30 mm	NE	-	25	250	

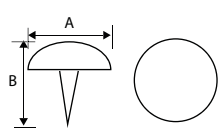

Acero
●
NEGRO

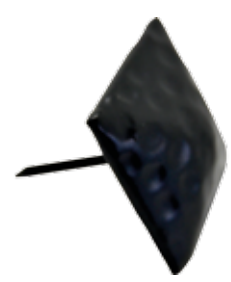

CLAVO PIRÁMIDE CL3

	Código	8431488	Medida AxB	Acabado				€uros
Caja	11729	117294	25x30 mm	NE	-	25	250	
	11703	117034	30x30 mm	NE	-	25	250	
	11730	117300	35x30 mm	NE	-	25	250	

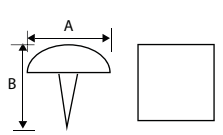

Acero
●
NEGRO



CLAVO 8 PICOS CL4

	Código	8431488	Medida AxB	Acabado				€uros
Caja	11731	117317	30x30 mm	NE	-	25	250	
	11732	117324	40x30 mm	NE	-	25	250	

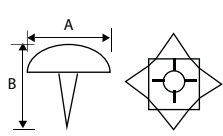

Acero
●
NEGRO



CLAVO 4 PICOS CL5

	Código	8431488	Medida AxB	Acabado				€uros
Caja	11733	117331	20x20 mm	NE	-	25	250	
	11734	117348	40x30 mm	NE	-	25	250	

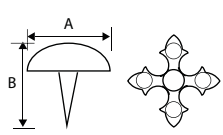

Acero
●
NEGRO

PLACA CIEGA PLP1

	Código	8431488	Medida AxB	Acabado				€uros
	97816	978161	60x35 mm	LP	-	2	-	
	97817	978178	60x35 mm	LS	-	2	-	
	97818	978185	60x35 mm	NS	-	2	-	
	97819	978192	60x60 mm	LP	-	2	-	
	97820	978208	60x60 mm	LS	-	2	-	
	97821	978215	60x60 mm	NS	-	2	-	
	97822	978222	80x60 mm	LP	-	2	-	
	97823	978239	80x60 mm	LS	-	2	-	
	97824	978246	80x60 mm	NS	-	2	-	
	97801	978017	80x80 mm	LP	-	2	-	
	97802	978024	80x80 mm	LS	-	2	-	
	97803	978031	80x80 mm	NS	-	2	-	
	97804	978048	100x70 mm	LP	-	2	-	
	97805	978055	100x70 mm	LS	-	2	-	
	97806	978062	100x70 mm	NS	-	2	-	
	97807	978079	250x90 mm	LP	-	2	-	
	97808	978086	250x90 mm	LS	-	2	-	
	97809	978093	250x90 mm	NS	-	2	-	
	Blister	91522	915227	60x35 mm	LP	1	-	10
91523		915234	60x35 mm	LS	1	-	10	
91524		915241	60x35 mm	NS	1	-	10	
91525		915258	60x60 mm	LP	1	-	10	
91526		915265	60x60 mm	LS	1	-	10	
91527		915272	60x60 mm	NS	1	-	10	
91528		915289	80x60 mm	LP	1	-	10	
91529		915296	80x60 mm	LS	1	-	10	
91530		915302	80x60 mm	NS	1	-	10	
90479		904795	80x80 mm	LP	1	-	10	
90480		904801	80x80 mm	LS	1	-	10	
90481		904818	80x80 mm	NS	1	-	10	
90482		904825	100x70 mm	LP	1	-	10	
90483		904832	100x70 mm	LS	1	-	10	
90484		904849	100x70 mm	NS	1	-	10	



Latón



Espesor 1 mm

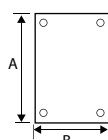

PLACA CIEGA PLP3

	Código	8431488	Medida AxB	Acabado				€uros
	97834	978345	600x250 mm	INOX	-	1	-	
	97835	978352	700x250 mm	INOX	-	1	-	
	97836	978369	800x250 mm	INOX	-	1	-	
	97837	978376	900x250 mm	INOX	-	1	-	
	97838	978383	1000x250 mm	INOX	-	1	-	
	97839	978390	1200x250 mm	INOX	-	1	-	

Acero Inoxidable



Espesor 1 mm

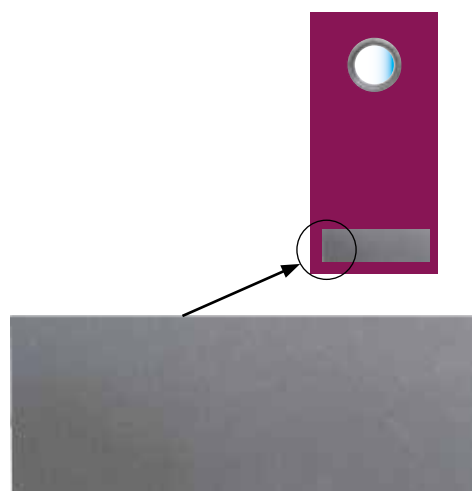
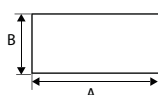



PLACA BOCALLAVE PLP2



Código	8431488	Medida AxB	Acabado				€uros
97825	978253	60x35 mm	LP	-	2	-	
97826	978260	60x35 mm	LS	-	2	-	
97827	978277	60x35 mm	NS	-	2	-	
97828	978284	60x60 mm	LP	-	2	-	
97829	978291	60x60 mm	LS	-	2	-	
97830	978307	60x60 mm	NS	-	2	-	
97831	978314	80x60 mm	LP	-	2	-	
97832	978321	80x60 mm	LS	-	2	-	
97833	978338	80x60 mm	NS	-	2	-	
97810	978109	80x80 mm	LP	-	2	-	
97811	978116	80x80 mm	LS	-	2	-	
97812	978123	80x80 mm	NS	-	2	-	
97813	978130	100x70 mm	LP	-	2	-	
97814	978147	100x70 mm	LS	-	2	-	
97815	978154	100x70 mm	NS	-	2	-	
Blister							
91531	915319	60x35 mm	LP	1	-	10	
91532	915326	60x35 mm	LS	1	-	10	
91533	915333	60x35 mm	NS	1	-	10	
91534	915340	60x60 mm	LP	1	-	10	
91535	915357	60x60 mm	LS	1	-	10	
91536	915364	60x60 mm	NS	1	-	10	
91537	915371	80x60 mm	LP	1	-	10	
91538	915388	80x60 mm	LS	1	-	10	
91539	915395	80x60 mm	NS	1	-	10	
90485	904856	80x80 mm	LP	1	-	10	
90486	904863	80x80 mm	LS	1	-	10	
90487	904870	80x80 mm	NS	1	-	10	
90488	904887	100x70 mm	LP	1	-	10	
90489	904894	100x70 mm	LS	1	-	10	
90490	904900	100x70 mm	NS	1	-	10	



Espesor 1 mm

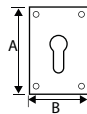

PLACA PISA PUERTA PLP4

Código	8431488	Medida	Acabado				€uros
97842	978420	147x98 mm	LS	-	1	5	

Espesor 5 mm

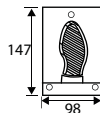

PLACA PISA PUERTA PLP5

Código	8431488	Medida	Acabado				€uros
97843	978437	147x98 mm	LS	-	1	5	
97844	978444	147x98 mm	INOX	-	1	5	
97845	978451	147x98 mm	NE	-	1	5	

Espesor 1 mm

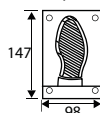

97843: Latón - 97844: Acero Inoxidable - 97845: Acero



ESCUDO SEGURIDAD ES2

	Código	8431488	Medida	Acabado				€uros
Caja	97931	979311	60 mm	LS	-	1	20	
	97932	979328	60 mm	NS	-	1	20	
Blister	91689	916897	60 mm	LS	1	-	10	
	91690	916903	60 mm	NS	1	-	10	

Zamak

Grosor 10 mm

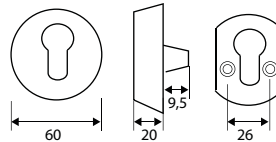

ESCUDO SEGURIDAD ES1

	Código	8431488	Medida	Acabado				€uros
Caja	97941	979410	63 mm	LS	-	1	20	
	97942	979427	63 mm	NS	-	1	20	
Blister	91691	916910	63 mm	LS	1	-	10	
	91692	916927	63 mm	NS	1	-	10	

Zamak

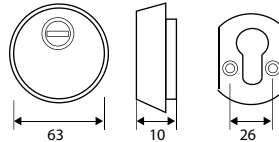

ESCUDO SEGURIDAD ES3

	Código	8431488	Medida	Acabado				€uros
Caja	97943	979434	65 mm	LS	-	1	50	
	97944	979441	65 mm	NS	-	1	50	
Blister	92323	923239	65 mm	LS	1	-	10	
	92324	923246	65 mm	NS	1	-	10	

Acero

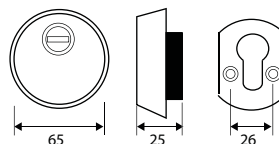

Te sugiero:

BOCALLAVES
Pág. 48-49



MULETILLAS
Pág. 50-51-52





ANTI-BUMPING
ANTI-TALADRO
ANTI-SNAP
ANTI-GANZÚA
DOBLE EMBRAGUE
6 PINES



SEGURIDAD CS1 L15

	Código	8431488	Medida AxB	Acabado				€uros
Caja	13174	131740	30x30 mm	LT	-	1	10	
	13175	131757	30x30 mm	NI	-	1	10	
	13176	131764	35x35 mm	LT	-	1	10	
	13177	131771	35x35 mm	NI	-	1	10	
	13178	131788	30x40 mm	LT	-	1	10	
	13179	131795	30x40 mm	NI	-	1	10	
	13180	131801	40x40 mm	LT	-	1	10	
	13181	131818	40x40 mm	NI	-	1	10	
	13182	131825	30x50 mm	LT	-	1	10	
	13183	131832	30x50 mm	NI	-	1	10	
	13184	131849	45x45 mm	LT	-	1	10	
	13185	131856	45x45 mm	NI	-	1	10	
	13186	131863	30x60 mm	LT	-	1	10	
	13187	131870	30x60 mm	NI	-	1	10	
Blister	92190	921907	30x30 mm	LT	1	-	10	
	92191	921914	30x30 mm	NI	1	-	10	
	92192	921921	35x35 mm	LT	1	-	10	
	92193	921938	35x35 mm	NI	1	-	10	
	92194	921945	30x40 mm	LT	1	-	10	
	92195	921952	30x40 mm	NI	1	-	10	

LEVA LARGA

5 Llaves con cabeza de goma

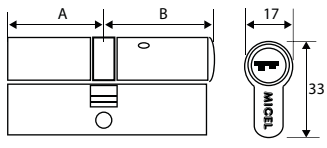

Latón
 LATÓN
 NÍQUEL

CILINDRO SEGURIDAD CS1 L13

	Código	8431488	Medida AxB	Acabado				€uros
Caja	13192	131924	30x30 mm	NI	-	1	10	
	13193	131931	35x35 mm	NI	-	1	10	
	13194	131948	30x40 mm	NI	-	1	10	
Blister	92196	921969	30x30 mm	NI	1	-	10	
	92197	921976	35x35 mm	NI	1	-	10	
	92198	921983	30x40 mm	NI	1	-	10	

LEVA CORTA

5 Llaves con cabeza de goma

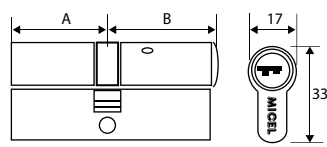

Latón
 NÍQUEL

LLAVE BRUTO CILINDRO CS1

	Código	8431488	Medida	Acabado			€uros
Caja	13195	131955	--	NI	-	10 250	

Latón

Llave con cabeza de goma

 NIQUEL

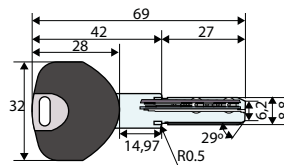

LEVA L13 P/CILINDRO CS1

	Código	8431488	Medida	Acabado			€uros
Caja	13345	133454	L13	NE	-	25 625	

Acero

 NEGRO

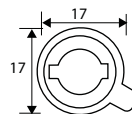

ESTUCHE AMAESTRAMIENTO CILINDRO CS1

	Código	8431488	Medida	Acabado			€uros
Caja	13343	133430	250X190 mm	NA	-	1 -	

Plástico

 NARANJA

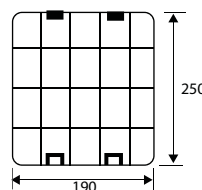

Incluye:

- 1 bolsa muelle inox
- 6 bolsas pitones
- 1 bolsa nuevos pitones
- 5 bolsas suplementos amaestramiento
- 1 bolsa contrapitones
- 1 bolsa pitón interior
- 1 bolsa nuevo contrapitón
- 1 bolsa tapones
- 1 bolsa grapas



ANTI-BUMPING
ANTI-TALADRO

Muelles de Inox
6 pitones de latón

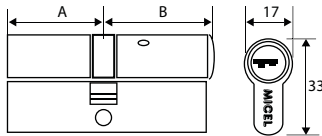

CILINDRO SEGURIDAD CS4 L15

	Código	8431488	Medida AxB	Acabado				€uros
Caja	13304	133041	30x30 mm	LT	-	1	25	
	13305	133058	30x30 mm	NI	-	1	25	
	13306	133065	35x35 mm	LT	-	1	25	
	13307	133072	35x35 mm	NI	-	1	25	
	13308	133089	30x40 mm	LT	-	1	25	
	13309	133096	30x40 mm	NI	-	1	25	
	13310	133102	40x40 mm	LT	-	1	25	
	13311	133119	40x40 mm	NI	-	1	25	
	13312	133126	30x50 mm	LT	-	1	25	
	13313	133133	30x50 mm	NI	-	1	25	
Blister	92236	922362	30x30 mm	LT	1	-	10	
	92237	922379	30x30 mm	NI	1	-	10	
	92238	922386	35x35 mm	LT	1	-	10	
	92239	922393	35x35 mm	NI	1	-	10	
	92240	922409	30x40 mm	LT	1	-	10	
	92241	922416	30x40 mm	NI	1	-	10	

CS4 L15 LLAVES IGUALES GRUPO 1

	Código	8431488	Medida AxB	Acabado				€uros
Caja	13317	133171	30x30 mm	LT	-	1	25	
	13318	133188	30x30 mm	NI	-	1	25	
	13319	133195	35x35 mm	LT	-	1	25	
	13320	133201	35x35 mm	NI	-	1	25	
	13321	133218	30x40 mm	LT	-	1	25	
	13322	133225	30x40 mm	NI	-	1	25	

CS4 L15 LLAVES IGUALES GRUPO 2

	Código	8431488	Medida AxB	Acabado				€uros
Caja	13198	131986	30x30 mm	LT	-	1	25	
	13199	131993	30x30 mm	NI	-	1	25	
	13200	132006	35x35 mm	LT	-	1	25	
	13201	132013	35x35 mm	NI	-	1	25	
	13202	132020	30x40 mm	LT	-	1	25	
	13203	132037	30x40 mm	NI	-	1	25	

CS4 L15 LLAVES IGUALES GRUPO 3

	Código	8431488	Medida AxB	Acabado				€uros
Caja	13207	132075	30x30 mm	LT	-	1	25	
	13208	132082	30x30 mm	NI	-	1	25	
	13209	132099	35x35 mm	LT	-	1	25	
	13210	132105	35x35 mm	NI	-	1	25	
	13211	132112	30x40 mm	LT	-	1	25	
	13212	132129	30x40 mm	NI	-	1	25	

LEVA LARGA
Todas las medidas de cada grupo usan la misma llave



CILINDRO SEGURIDAD CS4 L13



	Código	8431488	Medida AxB	Acabado				€uros
Caja	13314	133140	30x30 mm	NI	-	1	25	
	13315	133157	35x35 mm	NI	-	1	25	
	13316	133164	30x40 mm	NI	-	1	25	
Blister	92242	922423	30x30 mm	NI	1	-	10	
	92243	922430	35x35 mm	NI	1	-	10	
	92244	922447	30x40 mm	NI	1	-	10	

Latón

LEVA CORTA



CS4 L13 LLAVES IGUALES GRUPO 1



	Código	8431488	Medida AxB	Acabado				€uros
Caja	13323	133232	30x30 mm	NI	-	1	25	
	13324	133249	35x35 mm	NI	-	1	25	
	13325	133256	30x40 mm	NI	-	1	25	





ANTI-BUMPING
ANTI-TALADRO

Muelles de Inox
6 pitones de latón

CS4 L13 LLAVES IGUALES GRUPO 2

	Código	8431488	Medida AxB	Acabado				€uros
Caja	13204	132044	30x30 mm	NI	-	1	25	
	13205	132051	35x35 mm	NI	-	1	25	
	13206	132068	30x40 mm	NI	-	1	25	

CS4 L13 LLAVES IGUALES GRUPO 3

	Código	8431488	Medida AxB	Acabado				€uros
Caja	13213	132136	30x30 mm	NI	-	1	25	
	13214	132143	35x35 mm	NI	-	1	25	
	13215	132150	30x40 mm	NI	-	1	25	

Latón

LEVA CORTA



Todas las medidas de cada grupo usan la misma llave

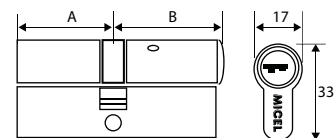



CILINDRO SEGURIDAD CS2 L15

COMPLEMENTOS PUERTA

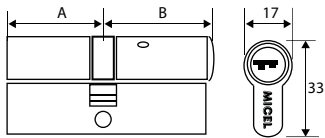

	Código	843 I488	Medida AxB	Acabado				€uros
Caja	13031	130316	30x30 mm	LT	-	1	25	
	13032	130323	30x30 mm	NI	-	1	25	
	13033	130330	35x35 mm	LT	-	1	25	
	13034	130347	35x35 mm	NI	-	1	25	
	13035	130354	30x40 mm	LT	-	1	25	
	13036	130361	30x40 mm	NI	-	1	25	
	13037	130378	40x40 mm	LT	-	1	25	
	13038	130385	40x40 mm	NI	-	1	25	
	13039	130392	30x50 mm	LT	-	1	25	
	13040	130408	30x50 mm	NI	-	1	25	
	13079	130798	45x45 mm	LT	-	1	25	
	13080	130804	45x45 mm	NI	-	1	25	
	13081	130811	30x60 mm	LT	-	1	25	
	13082	130828	30x60 mm	NI	-	1	25	
	13041	130415	40x50 mm	LT	-	1	25	
	13042	130422	40x50 mm	NI	-	1	25	
	13083	130835	50x50 mm	LT	-	1	25	
	13084	130842	50x50 mm	NI	-	1	25	
	13089	130897	40x60 mm	LT	-	1	25	
	13090	130903	40x60 mm	NI	-	1	25	
13091	130910	30x70 mm	LT	-	1	25		
13092	130927	30x70 mm	NI	-	1	25		
13093	130934	60x60 mm	LT	-	1	25		
13094	130941	60x60 mm	NI	-	1	25		
13095	130958	40x80 mm	LT	-	1	25		
13096	130965	40x80 mm	NI	-	1	25		
Blister	91253	912530	30x30 mm	LT	1	-	10	
	91254	912547	30x30 mm	NI	1	-	10	
	91255	912554	35x35 mm	LT	1	-	10	
	91256	912561	35x35 mm	NI	1	-	10	
	91257	912578	30x40 mm	LT	1	-	10	
	91258	912585	30x40 mm	NI	1	-	10	
	91259	912592	40x40 mm	LT	1	-	10	
	91260	912608	40x40 mm	NI	1	-	10	
	91261	912615	30x50 mm	LT	1	-	10	
	91262	912622	30x50 mm	NI	1	-	10	
	91263	912639	40x50 mm	LT	1	-	10	
	91264	912646	40x50 mm	NI	1	-	10	
	91602	916026	45x45 mm	LT	1	-	10	
	91603	916033	45x45 mm	NI	1	-	10	
	91693	916934	30x60 mm	LT	1	-	10	
	91694	916941	30x60 mm	NI	1	-	10	
91695	916958	50x50 mm	LT	1	-	10		
91696	916965	50x50 mm	NI	1	-	10		

LEVA LARGA

Latón



LATÓN



NIQUEL

CS2 L15 LLAVES IGUALES

	Código	8431488	Medida AxB	Acabado				€uros
Caja	13123	131238	30x30 mm	LT	-	1	25	
	13124	131245	30x30 mm	NI	-	1	25	
	13125	131252	35x35 mm	LT	-	1	25	
	13126	131269	35x35 mm	NI	-	1	25	
	13127	131276	30x40 mm	LT	-	1	25	
	13128	131283	30x40 mm	NI	-	1	25	
	13129	131290	40x40 mm	LT	-	1	25	
	13130	131306	40x40 mm	NI	-	1	25	
	13131	131313	30x50 mm	LT	-	1	25	
13132	131320	30x50 mm	NI	-	1	25		

Latón



LEVA LARGA



CILINDRO SEGURIDAD CS2 L13

	Código	8431488	Medida AxB	Acabado				€uros
Caja	13043	130439	30x10 mm	NI	-	1	25	
	13044	130446	40x10 mm	NI	-	1	25	
	13097	130972	30x30 mm	LT	-	1	25	
	13045	130453	30x30 mm	NI	-	1	25	
	13098	130989	35x35 mm	LT	-	1	25	
	13046	130460	35x35 mm	NI	-	1	25	
	13099	130996	30x40 mm	LT	-	1	25	
	13047	130477	30x40 mm	NI	-	1	25	
	13100	131009	40x40 mm	LT	-	1	25	
	13048	130484	40x40 mm	NI	-	1	25	
	13101	131016	30x50 mm	LT	-	1	25	
	13102	131023	30x50 mm	NI	-	1	25	
Blister	91265	912653	30x10 mm	NI	1	-	10	
	91266	912660	40x10 mm	NI	1	-	10	
	91836	918365	30x30 mm	LT	1	-	10	
	91267	912677	30x30 mm	NI	1	-	10	
	91837	918372	35x35 mm	LT	1	-	10	
	91268	912684	35x35 mm	NI	1	-	10	
	91838	918389	30x40 mm	LT	1	-	10	
	91269	912691	30x40 mm	NI	1	-	10	
	91839	918396	40x40 mm	LT	1	-	10	
	91270	912707	40x40 mm	NI	1	-	10	
91840	918402	30x50 mm	LT	1	-	10		
91841	918419	30x50 mm	NI	1	-	10		

Latón



LEVA CORTA

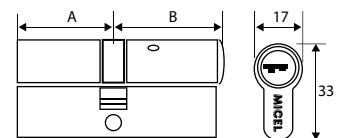

CS2 L13 LLAVES IGUALES

	Código	8431488	Medida AxB	Acabado				€uros
Caja	13133	131337	30x30 mm	NI	-	1	25	
	13134	131344	35x35 mm	NI	-	1	25	
	13135	131351	30x40 mm	NI	-	1	25	
	13136	131368	40x40 mm	NI	-	1	25	
	13137	131375	30x50 mm	NI	-	1	25	

Latón



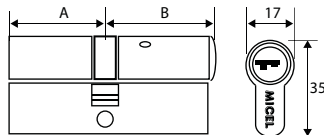

LEVA LARGA

Latón



LATÓN



NIQUEL

CILINDRO SERRETA CS3 L15

Código	8431488	Medida AxB	Acabado				€uros
13087	130873	23x23 mm	LT	-	1	25	
13088	130880	23x23 mm	NI	-	1	25	
13103	131030	30x10 mm	LT	-	1	25	
13104	131047	30x10 mm	NI	-	1	25	
13105	131054	40x10 mm	LT	-	1	25	
13106	131061	40x10 mm	NI	-	1	25	
13107	131078	50x10 mm	LT	-	1	25	
13108	131085	50x10 mm	NI	-	1	25	
13109	131092	60x10 mm	LT	-	1	25	
13110	131108	60x10 mm	NI	-	1	25	
13049	130491	30x30 mm	LT	-	1	25	
13050	130507	30x30 mm	NI	-	1	25	
13051	130514	35x35 mm	LT	-	1	25	
13052	130521	35x35 mm	NI	-	1	25	
13053	130538	30x40 mm	LT	-	1	25	
13054	130545	30x40 mm	NI	-	1	25	
13055	130552	40x40 mm	LT	-	1	25	
13056	130569	40x40 mm	NI	-	1	25	
13057	130576	30x50 mm	LT	-	1	25	
13058	130583	30x50 mm	NI	-	1	25	
13085	130859	45x45 mm	LT	-	1	25	
13086	130866	45x45 mm	NI	-	1	25	
13111	131115	30x60 mm	LT	-	1	25	
13112	131122	30x60 mm	NI	-	1	25	
13059	130590	40x50 mm	LT	-	1	25	
13060	130606	40x50 mm	NI	-	1	25	
13113	131139	50x50 mm	LT	-	1	25	
13114	131146	50x50 mm	NI	-	1	25	
13115	131153	40x60 mm	LT	-	1	25	
13116	131160	40x60 mm	NI	-	1	25	
13117	131177	30x70 mm	LT	-	1	25	
13118	131184	30x70 mm	NI	-	1	25	
13119	131191	60x60 mm	LT	-	1	25	
13120	131207	60x60 mm	NI	-	1	25	
13121	131214	40x80 mm	LT	-	1	25	
13122	131221	40x80 mm	NI	-	1	25	

Caja

CS3 L15 LLAVES IGUALES

Código	8431488	Medida AxB	Acabado				€uros
13170	130702	30x10 mm	LT	-	1	25	
13171	131719	30x10 mm	NI	-	1	25	
13069	130699	30x30 mm	LT	-	1	25	
13070	130705	30x30 mm	NI	-	1	25	
13071	130712	35x35 mm	LT	-	1	25	
13072	130729	35x35 mm	NI	-	1	25	
13073	130736	30x40 mm	LT	-	1	25	
13074	130743	30x40 mm	NI	-	1	25	
13138	131382	40x40 mm	LT	-	1	25	
13139	131399	40x40 mm	NI	-	1	25	
13140	131405	30x50 mm	LT	-	1	25	
13141	131412	30x50 mm	NI	-	1	25	

Caja

CILINDRO SERRETA CS3 L15

Código	8431488	Medida AxB	Acabado				€uros
91833	918334	23x23 mm	LT	1	-	10	
91834	918341	23x23 mm	NI	1	-	10	
91842	918426	30x10 mm	LT	1	-	10	
91843	918433	30x10 mm	NI	1	-	10	
91844	918440	40x10 mm	LT	1	-	10	
91845	918457	40x10 mm	NI	1	-	10	
91271	912714	30x30 mm	LT	1	-	10	
91272	912721	30x30 mm	NI	1	-	10	
91273	912738	35x35 mm	LT	1	-	10	
91274	912745	35x35 mm	NI	1	-	10	
91275	912752	30x40 mm	LT	1	-	10	
91276	912769	30x40 mm	NI	1	-	10	
91277	912776	40x40 mm	LT	1	-	10	
91278	912783	40x40 mm	NI	1	-	10	
91279	912790	30x50 mm	LT	1	-	10	
91280	912806	30x50 mm	NI	1	-	10	
91281	912813	40x50 mm	LT	1	-	10	
91282	912820	40x50 mm	NI	1	-	10	
91604	916040	45x45 mm	LT	1	-	10	
91605	916057	45x45 mm	NI	1	-	10	

Blister

Latón



LATÓN



NIQUEL

LEVA LARGA

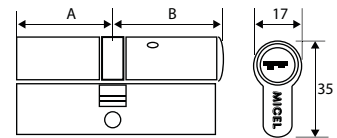

CS3 L15 LLAVES IGUALES

Código	8431488	Medida AxB	Acabado				€uros
92143	921433	30x30 mm	LT	2	-	10	
92144	921440	30x30 mm	NI	2	-	10	
92145	921457	35x35 mm	LT	2	-	10	
92146	921464	35x35 mm	NI	2	-	10	
92147	921471	30x40 mm	LT	2	-	10	
92148	921488	30x40 mm	NI	2	-	10	
92149	921495	40x40 mm	LT	2	-	10	
92150	921501	40x40 mm	NI	2	-	10	

Latón



LATÓN



NIQUEL

LEVA LARGA



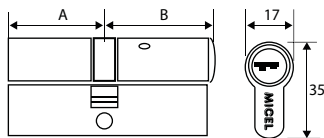

CILINDRO SERRETA CS3 L13

	Código	8431488	Medida AxB	Acabado				€uros
Caja	13061	130613	30x10 mm	NI	-	1	25	
	13062	130620	40x10 mm	NI	-	1	25	
	13144	131443	30x30 mm	LT	-	1	25	
	13063	130637	30x30 mm	NI	-	1	25	
	13145	131450	35x35 mm	LT	-	1	25	
	13064	130644	35x35 mm	NI	-	1	25	
	13146	131467	30x40 mm	LT	-	1	25	
	13065	130651	30x40 mm	NI	-	1	25	
	13147	131474	40x40 mm	LT	-	1	25	
	13066	130668	40x40 mm	NI	-	1	25	
	13148	131481	30x50 mm	LT	-	1	25	
13149	131498	30x50 mm	NI	-	1	25		
Blister	91283	912837	30x10 mm	NI	1	-	10	
	91284	912844	40x10 mm	NI	1	-	10	
	91846	918464	30x30 mm	LT	1	-	10	
	91285	912851	30x30 mm	NI	1	-	10	
	91847	918471	35x35 mm	LT	1	-	10	
	91286	912868	35x35 mm	NI	1	-	10	
	91848	918488	30x40 mm	LT	1	-	10	
	91287	912875	30x40 mm	NI	1	-	10	
	91849	918495	40x40 mm	LT	1	-	10	
	91288	912882	40x40 mm	NI	1	-	10	
	91850	918501	30x50 mm	LT	1	-	10	
91851	918518	30x50 mm	NI	1	-	10		

LEVA CORTA

Latón



LATÓN



NIQUEL

CS3 L13 LLAVES IGUALES

	Código	8431488	Medida AxB	Acabado				€uros
Caja	13075	130750	30x10 mm	NI	-	1	25	
	13076	130767	30x30 mm	NI	-	1	25	
	13077	130774	35x35 mm	NI	-	1	25	
	13078	130781	30x40 mm	NI	-	1	25	
	13142	131429	40x40 mm	NI	-	1	25	
	13143	131436	30x50 mm	NI	-	1	25	

LEVA LARGA

Latón



NIQUEL

CILINDRO SEGURIDAD POMO CS6 L15

	Código	8431488	Medida AxB	Acabado			€uros
Caja	13150	131504	30x30 mm	LT	-	1	25
	13151	131511	30x30 mm	NS	-	1	25
	13152	131528	35x35 mm	LT	-	1	25
	13153	131535	35x35 mm	NS	-	1	25
	13154	131542	30x40 mm	LT	-	1	25
	13155	131559	30x40 mm	NS	-	1	25
	13156	131566	40x40 mm	LT	-	1	25
	13157	131573	40x40 mm	NS	-	1	25
	13158	131580	30x50 mm	LT	-	1	25
	13159	131597	30x50 mm	NS	-	1	25
Blister	91852	918525	30x30 mm	LT	1	-	10
	91853	918532	30x30 mm	NS	1	-	10
	91854	918549	35x35 mm	LT	1	-	10
	91855	918556	35x35 mm	NS	1	-	10
	91856	918563	30x40 mm	LT	1	-	10
	91857	918570	30x40 mm	NS	1	-	10
	91858	918587	40x40 mm	LT	1	-	10
	91859	918594	40x40 mm	NS	1	-	10
	91860	918600	30x50 mm	LT	1	-	10
	91861	918617	30x50 mm	NS	1	-	10

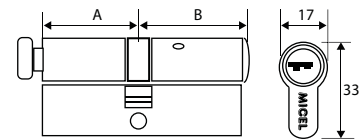

Latón



LEVA LARGA

Pomo siempre en medida A

CILINDRO SERRETA POMO CS7 L15

	Código	8431488	Medida AxB	Acabado			€uros
Caja	13160	131603	30x30 mm	LT	-	1	25
	13161	131610	30x30 mm	NS	-	1	25
	13162	131627	35x35 mm	LT	-	1	25
	13163	131634	35x35 mm	NS	-	1	25
	13164	131641	30x40 mm	LT	-	1	25
	13165	131658	30x40 mm	NS	-	1	25
	13166	131665	40x40 mm	LT	-	1	25
	13167	131672	40x40 mm	NS	-	1	25
	13168	131689	30x50 mm	LT	-	1	25
	13169	131696	30x50 mm	NS	-	1	25
Blister	91862	918624	30x30 mm	LT	1	-	10
	91863	918631	30x30 mm	NS	1	-	10
	91864	918648	35x35 mm	LT	1	-	10
	91865	918655	35x35 mm	NS	1	-	10
	91866	918662	30x40 mm	LT	1	-	10
	91867	918679	30x40 mm	NS	1	-	10
	91868	918686	40x40 mm	LT	1	-	10
	91869	918693	40x40 mm	NS	1	-	10
	91870	918709	30x50 mm	LT	1	-	10
	91871	918716	30x50 mm	NS	1	-	10

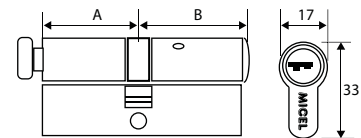

Latón



LEVA LARGA

Pomo siempre en medida A



LLAVES EN BRUTO P/CILINDRO CS2 Y CS3



13067

13068

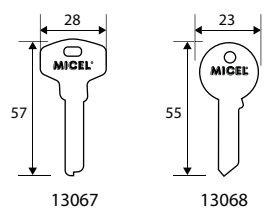

13067

13068

	Código	8431488	Tipo	Acabado				€uros
Caja	13067	130675	seguridad CS2	NI	-	10	250	
	13068	130682	serreta CS3	NI	-	10	250	

Latón



NIQUEL

TORNILLO P/CILINDROS TRN16

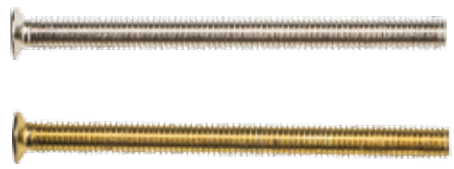

	Código	8431488	Medida A	Acabado				€uros
Caja	13172	131726	M5x65 mm	LTD	-	25	625	
	13173	131733	M5x65 mm	NI	-	25	625	
	13196	131962	M5x85 mm	LTD	-	25	625	
	13197	131979	M5x85 mm	NI	-	25	625	
Blister	92188	921884	M5x65 mm	LTD	4	-	10	
	92189	921891	M5x65 mm	NI	4	-	10	
	92209	922096	M5x85 mm	LTD	4	-	10	
	92210	922102	M5x85 mm	NI	4	-	10	

Acero

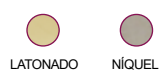

LATONADO

NIQUEL

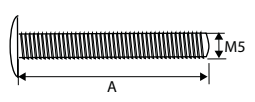

LEVA L13 P/CILINDRO CS2



	Código	8431488	Medida	Acabado				€uros
Caja	13003	130033	L13	NE	-	25	625	

Acero



NEGRO

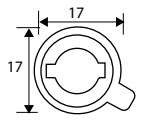

ADAPTADOR UNIFICADO CERRADURA CS8



	Código	8431488	Medida	Acabado				€uros
Caja	13002	130026	6 mm	ZN	-	25	250	
Blister	90902	909028	6 mm	ZN	1	-	10	

Acero



ZINCADO

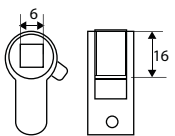

CERROJO SEGURIDAD SOBREPONER CRR1

	Código	8431488	Medida	Acabado				€uros
Caja	13299	132990	85x74 mm	LTD	-	1	24	
	13300	130003	85x74 mm	NI	-	1	24	

Acero

5 llaves de seguridad

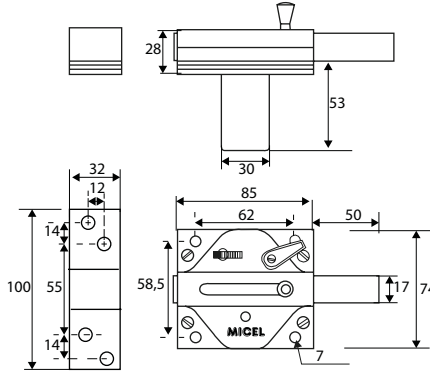

LLAVE BRUTO CERROJO CRR1

	Código	8431488	Tipo	Acabado				€uros
Caja	13365	133652	seguridad	NI	-	10	250	

Latón



CERROJO SEGURIDAD SOBREPONER CRR2

	Código	8431488	Medida	Acabado				€uros
Caja	13301	133010	106x65 mm	PINTADO	-	1	24	

Acero

5 llaves de seguridad

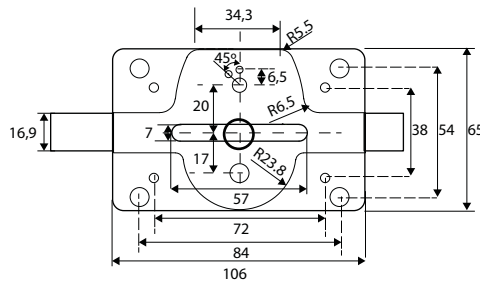

LLAVE BRUTO CERROJO CRR2

	Código	8431488	Tipo	Acabado				€uros
Caja	13366	133669	seguridad	NI	-	10	250	

Latón





VARILLA CUADRADILLO CDD4

	Código	8431488	Medida A	Acabado				€uros
Caja	00692	006925	6x1 mt	ZN	-	5	-	
	00894	008943	8x1 mt	ZN	-	5	-	

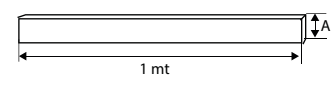

Acero
 ZINCADO

CUADRADILLO CDD1

	Código	8431488	Medida Ax B	Acabado				€uros
Caja	00689	006895	6x80 mm	ZN	-	25	100	
	00690	006901	6x90 mm	ZN	-	25	100	
	00691	006918	6x100 mm	ZN	-	25	100	
	00889	008899	8x80 mm	ZN	-	25	100	
	00890	008905	8x90 mm	ZN	-	25	100	
	00891	008912	8x100 mm	ZN	-	25	100	
	00892	008929	8x120 mm	ZN	-	25	50	
	00893	008936	8x150 mm	ZN	-	25	50	
	00888	008882	9x120 mm	BC	-	25	100	
Blister	90114	901145	6x90 mm	ZN	2	-	10	
	90115	901152	8x90 mm	ZN	2	-	10	

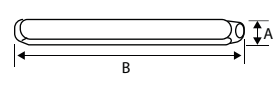

Acero
 ZINCADO BICROMATADO

CUADRADILLO RANURADO CDD2

	Código	8431488	Medida Ax B	Acabado				€uros
Caja	08103	081038	8x80 mm	ZN	-	25	100	
	08104	081045	8x90 mm	ZN	-	25	100	
	08105	081052	8x100 mm	ZN	-	25	100	
Blister	91629	916293	8x80 mm	ZN	2	-	10	
	91630	916309	8x90 mm	ZN	2	-	10	
	90113	901138	8x100 mm	ZN	2	-	10	

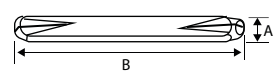

Acero
 ZINCADO

CUADRADILLO EXPANSIÓN CDD3

	Código	8431488	Medida Ax B	Acabado				€uros
Caja	00855	008554	8x55 mm	ZN	-	25	100	
	69402	694023	8x65 mm	ZN	-	25	100	
Blister	90663	906638	8x55 mm	ZN	2	-	10	
	90112	901121	8x65 mm	ZN	2	-	10	

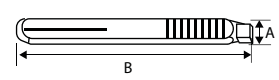

Acero
 ZINCADO

PLACA CUADRADILLO FIJO CDD5 Y CDD6

	Código	8431488	Tipo/Medida	Acabado				€uros
Caja	69405	694054	cuadradillo/8 mm	ZN	-	25	100	
	69406	694061	espárrago/8 mm	ZN	-	25	100	

Acero

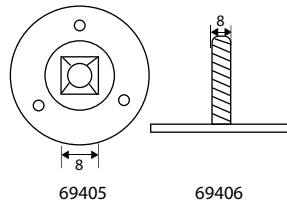

REDUCTOR CUADRADILLO CDD7

	Código	8431488	Medida A - B	Acabado				€uros
Caja	00086	000862	8 - 6 mm	ZN	-	25	100	
Blister	90116	901169	8 - 6 mm	ZN	4	-	10	

Acero

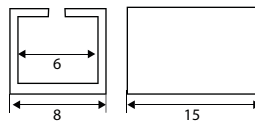

REDUCTOR CUADRADILLO CDD8

	Código	8431488	Medida A - B	Acabado				€uros
Caja	00088	000886	7 - 6 mm	NE	-	25	100	
	00087	000879	8 - 7 mm	NE	-	25	100	
	00089	000893	9 - 8 mm	NE	-	25	100	
Blister	91542	915425	7 - 6 mm	NE	4	-	10	
	91543	915432	8 - 7 mm	NE	4	-	10	
	91544	915449	9 - 8 mm	NE	4	-	10	

Nylon

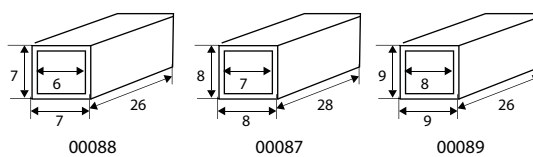



ESCUDO TAPAPOMO REDONDO ES4



	Código	8431488	Medida	Acabado				€uros
Caja	10040	100401	60 mm	LP	-	2	50	
	10241	100418	60 mm	NS	-	2	50	
Blister	90900	909004	60 mm	LP	2	-	10	
	90901	909011	60 mm	NS	2	-	10	

Válido para cubrir el hueco del pomo

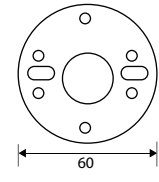

Acero
 LATÓN PULIDO
 NÍQUEL SATINADO



ESCUDO TAPAPOMO CUADRADO ES5

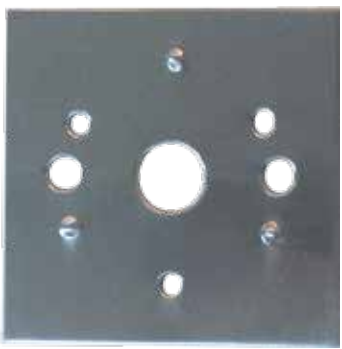

	Código	8431488	Tipo / Medida	Acabado				€uros
Caja	10402	104027	60x60 mm	LP	-	2	-	
	10403	104034	60x60 mm	NS	-	2	-	

Válido para cubrir el hueco del pomo

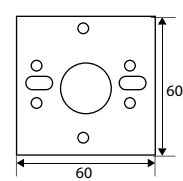

Latón
 LATÓN PULIDO
 NÍQUEL SATINADO

PUNTILLA CABEZA PERDIDA PNT1



	Código	8431488	Medida	Acabado				€uros
Caja	80029	800295	0,9x25 mm	ZN	-	1000	25000	
Blister	90592	905921	0,9x25 mm	ZN	50	-	10	

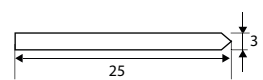

Acero
 ZINCADO

TORNILLO PASANTE TRN1

	Código	8431488	Medida	Acabado			€uros
Caja	40101	401010	M3x55	LTD	-	25	625
	40102	401027	M3x55	NS	-	25	625

Acero

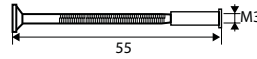

TORNILLO PASANTE MULTICORTE TRN2

	Código	8431488	Medida	Acabado			€uros
Caja	40105	401058	M4x75 mm	LTD	-	25	250
	40106	401065	M4x75 mm	NS	-	25	250
Blister	90664	906645	M4x75 mm	LTD	4	-	10
	90745	907451	M4x75 mm	NS	4	-	10

Acero



Con sistema anti-robo

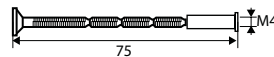

TORNILLO PASANTE TUBO TRN3

	Código	8431488	Medida AxBxC	Acabado			€uros
Caja	40108	401089	M3x60x43 mm	ZN	-	100	2500
	40109	401096	M4x75x32 mm	ZN	-	100	2500
Blister	91540	915401	M3x60x43 mm	ZN	4	-	10
	91541	915418	M4x75x32 mm	ZN	4	-	10

Acero

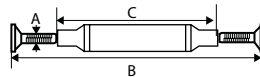

TORNILLO PRISIONERO MANILLA TRN4

	Código	8431488	Medida	Acabado			€uros
Caja	10238	102382	M5x6 mm	INOX	-	25	625
	10255	102559	M6x6 mm	INOX	-	25	625
Blister	92272	922720	M5x6 mm	INOX	10	-	10
	92413	924137	M6x6mm	INOX	10	-	10

Acero Inoxidable

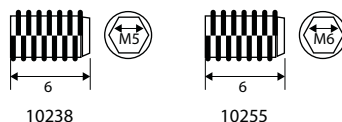



CUÑA DE MADERA PRC4

	Código	8431488	Medida AxBxC	Acabado				€uros
Caja	43575	435756	75x35x10 mm	PINO	-	100	1000	
	43576	435763	250x40x30 mm	PINO	-	100	-	
Blister	90197	901978	75x35x10 mm	PINO	2	-	10	

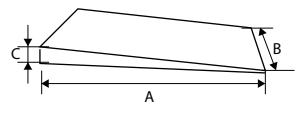

Madera



ANCLAJE PRECERCO "V" PRC1

	Código	8431488	Medida	Acabado				€uros
Caja	43001	430010	30x30 mm	NE	-	1000	-	

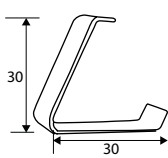

Acero



GARRA PRECERCO PRC2

	Código	8431488	Medida	Acabado				€uros
Caja	43002	430027	140x20 mm	ZN	-	500	-	

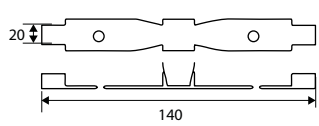

Acero



GARRA PRECERCO PRC3

	Código	8431488	Medida	Acabado				€uros
Caja	43003	430034	85x17,5 mm	ZN	-	1000	-	
Blister	91159	911595	85x17,5 mm	ZN	10	-	10	

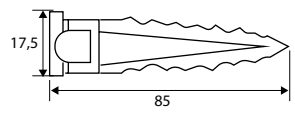

Acero



BURLETE ADHESIVO PVC BLT1

	Código	8431488	Medida A	Acabado				€uros
Blister	97134	971346	935 mm	BL	1	-	10	
	97136	971360	935 mm	RB	1	-	10	
	97137	971377	935 mm	SAPELI	1	-	10	
	97138	971384	1000 mm	TR	1	-	10	

PVC



Fleco de pelo

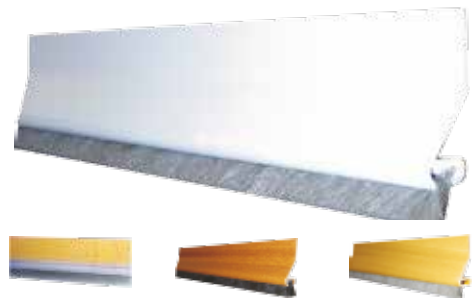
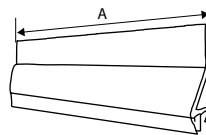

BURLETE ADHESIVO FLECO BLT4

	Código	8431488	Medida	Acabado				€uros
Blister	97121	971216	920 mm	PL	1	-	10	
	97122	971223	920 mm	BL	1	-	10	
	97123	971230	920 mm	SAPELI	1	-	10	
	97124	971247	920 mm	RB	1	-	10	
	97125	971254	920 mm	NE	1	-	10	

Aluminio



Fleco de pelo

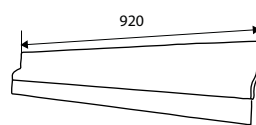

BURLETE ADHESIVO LABIO BLT5

	Código	8431488	Medida	Acabado				€uros
Blister	97126	971261	1050 mm	PL	1	-	10	
	97127	971278	1050 mm	RB	1	-	10	
	97128	971285	1050 mm	SAPELI	1	-	10	
	97129	971292	1050 mm	BL	1	-	10	

Aluminio



Fleco de Goma

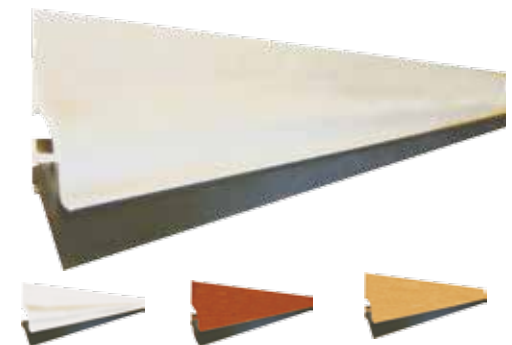
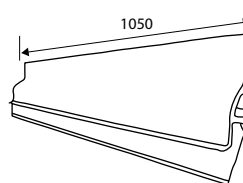

BURLETE ADHESIVO MADERA BLT3

	Código	8431488	Medida	Acabado				€uros
Blister	97147	971476	915 mm	BL	1	-	10	
	97148	971483	915 mm	PINO	1	-	10	
	97149	971490	915 mm	RB	1	-	10	
	97150	971506	915 mm	SAPELI	1	-	10	

Madera



Fleco de fieltro

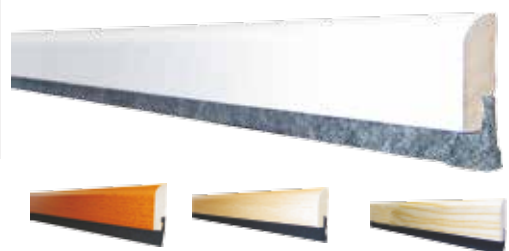
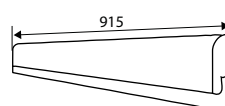



BURLETE BASCULANTE ALUMINIO BLT6

	Código	8431488	Medida	Acabado				€uros
Blister	97130	971308	930 mm	BL	1	-	6	
	97132	971322	930 mm	MA	1	-	6	

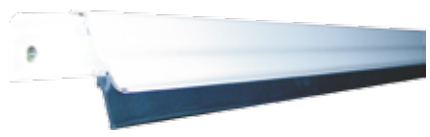

Fleco de goma

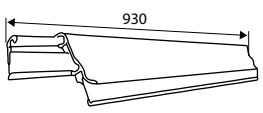

Aluminio



BURLETE AUTOMÁTIC BLT11

	Código	8431488	Medida A	Acabado				€uros
Blister	97186	971865	820 mm	BL	1	-	1	
	97187	971872	920 mm	BL	1	-	1	
	97188	971889	1020 mm	BL	1	-	1	
	97189	971896	820 mm	PL	1	-	1	
	97190	971902	920 mm	PL	1	-	1	
	97191	971919	1020 mm	PL	1	-	1	

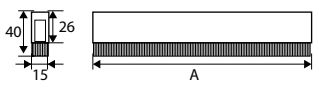

Aluminio



BURLETE BASCULANTE BLT10

	Código	8431488	Medida	Acabado				€uros
	97074	970745	625-825 mm	PL	-	1	-	
	97075	970752	625-825 mm	BL	-	1	-	
	97077	970776	625-825 mm	BR	-	1	-	



Fleco de goma

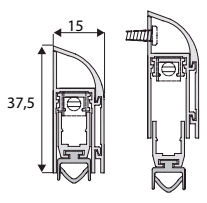

Aluminio



BURLETE EMBUTIR AUTOMÁTICO BLT9

	Código	8431488	Medida A	Acabado				€uros
	97073	970738	625-725 mm	PL	-	1	-	
	97083	970837	725-825 mm	PL	-	1	-	
	97093	970936	825-925 mm	PL	-	1	-	
	97103	971032	925-1025 mm	PL	-	1	-	
	97120	971209	1025-1125 mm	PL	-	1	-	

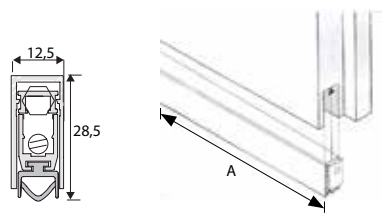

Aluminio



BURLETE BASCULANTE MADERA BLT2

	Código	8431488	Medida A	Acabado				€uros
Blister	97139	971391	815 mm	BL	1	-	10	
	97143	971438	815 mm	RB	1	-	10	
	97145	971452	815 mm	SAPALI	1	-	10	
	97140	971407	915 mm	BL	1	-	10	
	97142	971421	915 mm	PINO	1	-	10	
	97144	971445	915 mm	RB	1	-	10	
	97146	971469	915 mm	SAPALI	1	-	10	

Madera



Fleco de fieltro

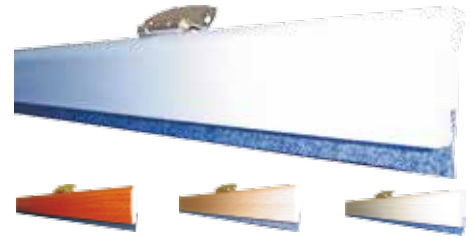
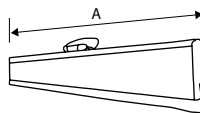

BURLETE GARAJE LABIO BLT7

	Código	8431488	Medida A	Acabado				€uros
Blister	97151	971513	2500 mm	BL	-	6	-	
	97152	971520	2500 mm	PL	-	6	-	
	97153	971537	2500 mm	NE	-	6	-	
	97192	971926	3050 mm	BL	-	6	-	
	97193	971933	3050 mm	PL	-	6	-	
	97194	971940	3050 mm	NE	-	6	-	

Aluminio



Labio de caucho

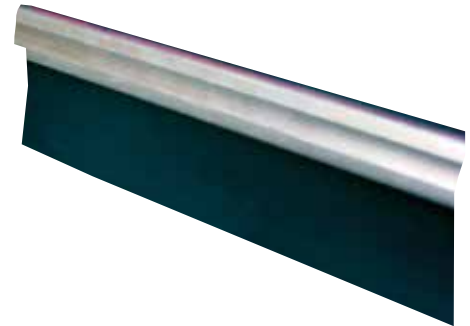
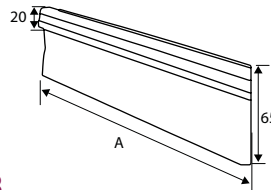

BURLETE GARAJE FLECOS BLT8

	Código	8431488	Medida	Acabado				€uros
Blister	97078	970783	2500 mm	BL	-	6	-	
	97079	970790	2500 mm	PL	-	6	-	
	97080	970806	2500 mm	NE	-	6	-	
	97081	970813	3050 mm	BL	-	6	-	
	97082	970820	3050 mm	PL	-	6	-	
	97084	970844	3050 mm	NE	-	6	-	

Aluminio



Flecos

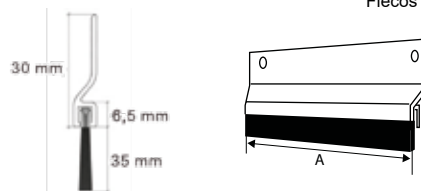

PERFIL PELDAÑO ESCALERA ADHESIVO TJ9

	Código	8431488	Medida A	Acabado				€uros
Blister	97197	971971	2000 mm	OR	-	10	-	
	97198	971988	2000 mm	PL	-	10	-	

Aluminio

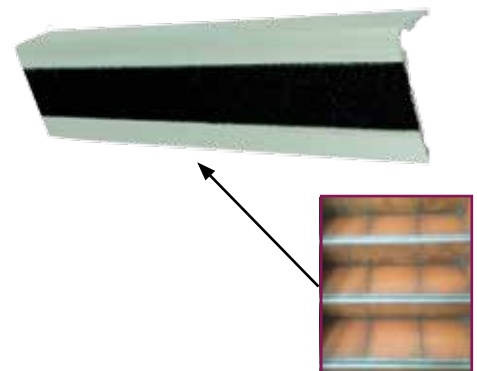
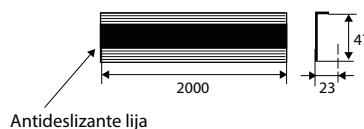



TAPAJUNTAS PLANO ADHESIVO TJ1



	Código	8431488	Medida A	Acabado				€uros
Blister	97154	971544	830 mm	OR	1	-	40	
	97155	971551	830 mm	PL	1	-	40	
	97158	971582	1000 mm	OR	1	-	40	
	97159	971599	1000 mm	PL	1	-	40	
	97195	971957	2500 mm	OR	-	10	-	
	97196	971964	2500 mm	PL	-	10	-	

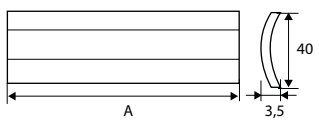

Aluminio
 ORO PLATA

TAPAJUNTAS PLANO TORNILLO TJ2



	Código	8431488	Medida A	Acabado				€uros
Blister	97162	971629	830 mm	OR	1	-	40	
	97163	971636	830 mm	PL	1	-	40	
	97166	971667	1000 mm	OR	1	-	40	
	97167	971674	1000 mm	PL	1	-	40	

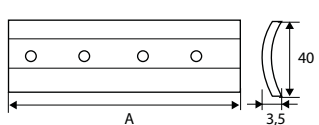

Aluminio
 ORO PLATA

TAPAJUNTAS ESCALÓN ADHESIVO TJ3



	Código	8431488	Medida A	Acabado				€uros
Blister	97170	971704	830 mm	OR	1	-	40	
	97171	971711	830 mm	PL	1	-	40	
	97174	971742	1000 mm	OR	1	-	40	
	97175	971759	1000 mm	PL	1	-	40	

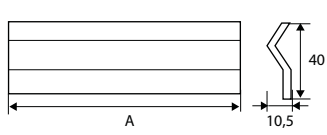

Aluminio
 ORO PLATA

TAPAJUNTAS ESCALÓN TORNILLO TJ4



	Código	8431488	Medida A	Acabado				€uros
Blister	97178	971780	830 mm	OR	1	-	40	
	97179	971797	830 mm	PL	1	-	40	
	97182	971827	1000 mm	OR	1	-	40	
	97183	971834	1000 mm	PL	1	-	40	

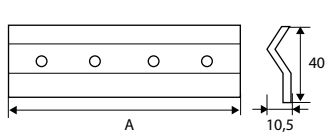

Aluminio
 ORO PLATA

TAPAJUNTAS PLANO ADHESIVO TJ5

	Código	8431488	Medida A	Acabado				€uros
Blister	97156	971568	830 mm	LTD	1	-	40	
	97157	971575	830 mm	INOX	1	-	40	
	97160	971605	1000 mm	LTD	1	-	40	
	97161	971612	1000 mm	INOX	1	-	40	

Acero Inoxidable

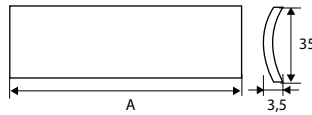

TAPAJUNTAS PLANO TORNILLO TJ6

	Código	8431488	Medida A	Acabado				€uros
Blister	97164	971643	830 mm	LTD	1	-	40	
	97165	971650	830 mm	INOX	1	-	40	
	97168	971681	1000 mm	LTD	1	-	40	
	97169	971698	1000 mm	INOX	1	-	40	

Acero Inoxidable

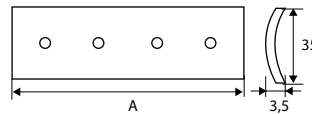

TAPAJUNTAS ESCALÓN ADHESIVO TJ7

	Código	8431488	Medida A	Acabado				€uros
Blister	97172	971728	830 mm	LTD	1	-	40	
	97173	971735	830 mm	INOX	1	-	40	
	97176	971766	1000 mm	LTD	1	-	40	
	97177	971773	1000 mm	INOX	1	-	40	

Acero Inoxidable

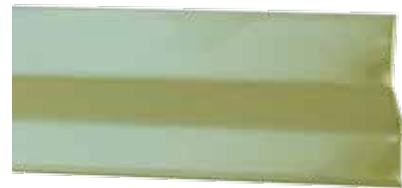
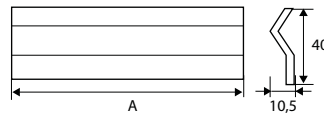

TAPAJUNTAS ESCALÓN TORNILLO TJ8

	Código	8431488	Medida A	Acabado				€uros
Blister	97180	971803	830 mm	LTD	1	-	40	
	97181	971810	830 mm	INOX	1	-	40	
	97184	971841	1000 mm	LTD	1	-	40	
	97185	971858	1000 mm	INOX	1	-	40	

Acero Inoxidable

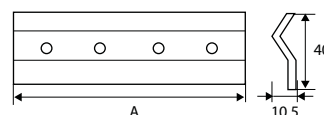



TOPE PUERTA RETENEDOR TP8



	Código	8431488	Medida	Acabado				€uros
Caja	10196	090023	90 mm	INOX	-	1	10	

Acero Inoxidable

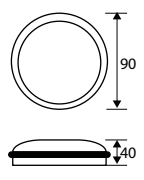

No es necesario atornillar al suelo
Apto para todos los pavimentos
Evita los golpes al abrir y cerrar puertas
Base antideslizante

INOX

TOPE PUERTA CLÁSICO TP9

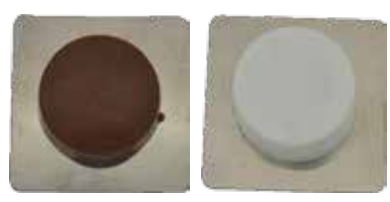

	Código	8431488	Medida AxBxC	Acabado				€uros
Caja	10229	102290	45x45x20 mm	BL	-	25	125	
	10230	102306	45x45x20 mm	MA	-	25	125	
Blister	91492	914923	45x45x20 mm	BL	2	-	10	
	91493	914930	45x45x20 mm	MA	2	-	10	

Adhesivo

Goma
 BLANCO
 MARRÓN

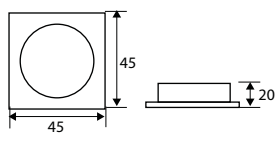

TOPE PUERTA RETENEDOR TP10

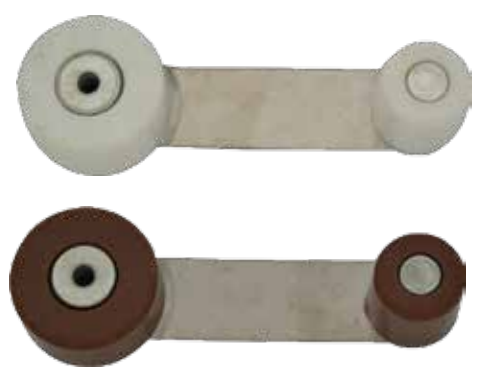

	Código	8431488	Medida	Acabado				€uros
Caja	10227	102276	100x25 mm	BL	-	25	125	
	10228	102283	100x25 mm	MA	-	25	125	
Blister	91494	914947	100x25 mm	BL	1	-	10	
	91495	914954	100x25 mm	MA	1	-	10	

Adhesivo

Goma
 BLANCO
 MARRÓN

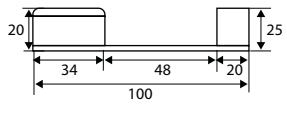

TOPE PUERTA RETENEDOR TP12



	Código	8431488	Medida	Acabado				€uros
Caja	10237	102375	110x28 mm	INOX	-	10	100	

Acero Inoxidable

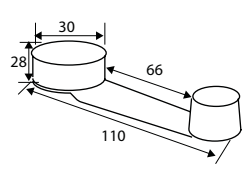

INOX

TOPE PUERTA LUX TP1

	Código	843 I 488	Medida	Acabado				€uros
Caja	10020	100203	45 mm	OR	-	25	250	
	10201	102016	45 mm	OM	-	25	250	
	10202	102023	45 mm	CB	-	25	250	
	10203	102030	45 mm	NS	-	25	250	
	10204	102047	45 mm	BL	-	25	250	
	10206	102061	45 mm	CU	-	25	250	
Blister	90125	901251	45 mm	OR	1	-	10	
	90126	901268	45 mm	OM	1	-	10	
	90127	901275	45 mm	CB	1	-	10	
	90128	901282	45 mm	NS	1	-	10	
	90129	901299	45 mm	BL	1	-	10	

Zamak



Taladro

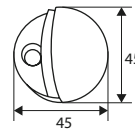

TOPE PUERTA LUX TP2

	Código	843 I 488	Medida	Acabado				€uros
Caja	10210	102108	45 mm	OR	-	25	250	
	10211	102115	45 mm	OM	-	25	250	
	10213	102139	45 mm	NS	-	25	250	
	10231	102313	45 mm	SAPELI	-	25	250	
Blister	90151	901510	45 mm	NS	1	-	10	

Zamak



Adhesivo

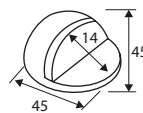

TOPE PUERTA LUX TP7

	Código	843 I 488	Medida	Acabado				€uros
Caja	10223	102238	47 mm	HAYA	-	25	500	
	10224	102245	47 mm	BL	-	25	500	
	10225	102252	47 mm	SAPELI	-	25	500	
	10226	102269	47 mm	RB	-	25	500	
	10236	102368	47 mm	GR	-	25	500	
Blister	90880	908809	47 mm	HAYA	2	-	10	
	90878	908786	47 mm	BL	2	-	10	
	90879	908793	47 mm	SAPELI	2	-	10	
	90877	908779	47 mm	RB	2	-	10	
	92212	922126	47 mm	GR	2	-	10	

Madera



Adhesivo

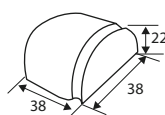



TOPE PUERTA SETA TP6



	Código	8431488	Medida	Acabado				€uros
Caja	10219	102191	32 mm	HAYA	-	25	500	
	10220	102207	32 mm	BL	-	25	500	
	10221	102214	32 mm	SAPELI	-	25	500	
	10222	102221	32 mm	RB	-	25	500	
	10235	102351	32 mm	GR	-	25	500	

Adhesivo

Madera

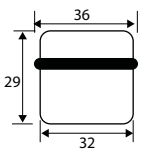

TOPE PUERTA SETA TP3



M4



	Código	8431488	Medida	Acabado				€uros
Caja	10019	100197	20 mm	LP	-	25	125	
	10192	101927	20 mm	CB	-	25	125	
	10193	101934	20 mm	NS	-	25	125	
	10198	101989	20 mm	INOX	-	25	125	
Blister	90133	901336	20 mm	LP	1	-	10	
	90135	901350	20 mm	NS	1	-	10	
	90140	901404	20 mm	INOX	1	-	10	

10019-10192-10193: Latón
10198: Acero Inoxidable
M4

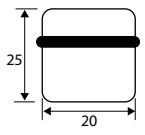

TOPE PUERTA SETA TP4



M4



	Código	8431488	Medida	Acabado				€uros
Caja	10016	100166	20 mm	LTD	-	25	125	
	10017	100173	20 mm	NS	-	25	125	
Blister	91699	916996	20 mm	NS	1	-	10	

Zamak
M4

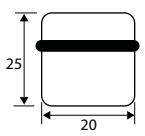

TOPE PUERTA SETA PARQUET TP5



	Código	8431488	Medida	Acabado				€uros
Caja	10199	101996	20 mm	INOX	-	25	125	
Blister	90138	901381	20 mm	INOX	1	-	10	

Acero Inoxidable

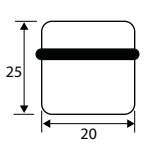

TOPE PUERTA STOP TP11

	Código	8431488	Medida	Acabado				€uros
Caja	10232	102320	55 mm	INOX	-	10	50	
Blister	91882	918822	55 mm	INOX	1	-	10	

Acero Inoxidable

Adhesivo

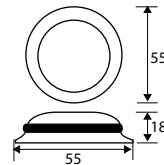

RETENEDOR PUERTA SUELO RT4

	Código	8431488	Medida	Acabado				€uros
Caja	18011	180113	60x30 mm	LTD	-	10	100	
	18012	180120	60x30 mm	CB	-	10	100	
Blister	90144	901442	60x30 mm	LTD	1	-	10	
	90145	901459	60x30 mm	CB	1	-	10	

Zamak

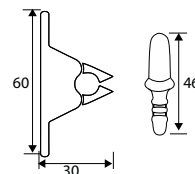

RETENEDOR PUERTA PARED RT5

	Código	8431488	Medida	Acabado				€uros
Caja	18001	180014	60x30 mm	LTD	-	10	100	
	18002	180021	60x30 mm	CB	-	10	100	
Blister	90146	901466	60x30 mm	LTD	1	-	10	
	90147	901473	60x30 mm	CB	1	-	10	

Zamak

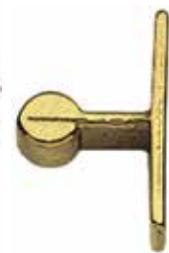
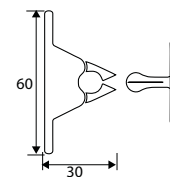

RETENEDOR PUERTA CLIP3

	Código	8431488	Medida	Acabado				€uros
Caja	30520	305202	40x33x36 mm	NE	-	10	50	

Nylon

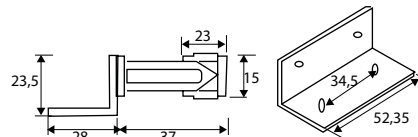



RETENEDOR PIE RT3

	Código	8431488	Medida AxB	Acabado				€uros
Caja	57301	573014	130x25 mm	BL	-	6	30	
	57302	573021	130x25 mm	NE	-	6	30	
	57303	573038	130x25 mm	OR	-	6	30	
	57304	573045	130x25 mm	PL	-	6	30	
	57311	573113	180x30 mm	BL	-	6	30	
	57312	573120	180x30 mm	NE	-	6	30	
	57313	573137	180x30 mm	OR	-	6	30	
	57314	573144	180x30 mm	PL	-	6	30	
Blister	90157	901572	130x25 mm	BL	1	-	10	
	90158	901589	130x25 mm	NE	1	-	10	
	90159	901596	130x25 mm	OR	1	-	10	
	90160	901602	130x25 mm	PL	1	-	10	

130x25 mm = Puertas ligeras (máximo 25 kgs)
 180x30 mm = Puertas de entrada (máximo 40 kgs)

Aluminio

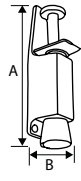

RETENEDOR PUERTA RT1

	Código	8431488	Medida	Acabado				€uros
Blister	30523	305233	108x63 mm	LTD	1	-	10	
	30524	305240	108x63 mm	NS	1	-	10	

Acero

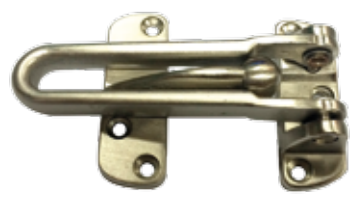
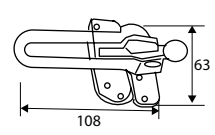

RETENEDOR CADENILLA RT2

	Código	8431488	Medida A	Acabado				€uros
Blister	30503	305035	85x38 mm	LTD	1	-	25	
	30504	305042	85x38 mm	NI	1	-	25	

Acero

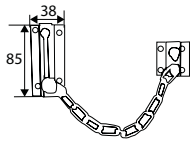
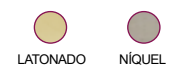

RETENEDOR FORMA "S"

	Código	8431488	Medida	Acabado			€uros
Caja	36025	360256	130x100 mm	NE	-	10	50
Blister	92427	924274	130x100 mm	NE	1	-	10

Acero

Espesor 4 mm

NEGRO

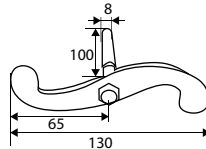

RETENEDOR VENTANA CLIP1

	Código	8431488	Medida	Acabado			€uros
	30518	305189	101 mm	NE	-	4	80
Blister	92232	922324	101 mm	NE	1	-	10

Nylon

NEGRO

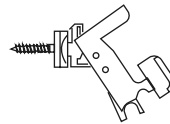
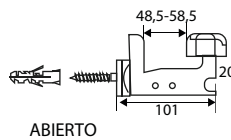
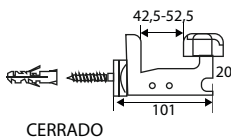

RETENEDOR VENTANA CLIP2

	Código	8431488	Medida	Acabado			€uros
Caja	30519	305196	42x15 mm	NE	-	10	240

Nylon

NEGRO

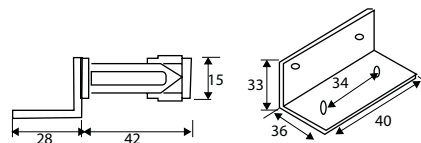

CIERRE VENTANA P/BAJO CV1

	Código	8431488	Medida	Acabado			€uros
Caja	69401	694016	62x44 mm	LT	-	25	125
Blister	90304	903040	62x44 mm	LT	1	-	10

Latón

LATÓN

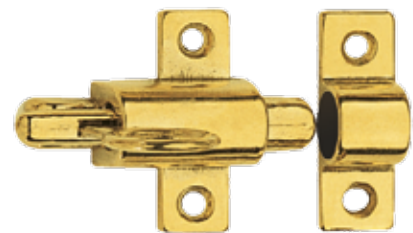
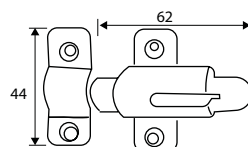



CIERRE PRESIÓN CP1

	Código	8431488	Medida	Acabado				€uros
Caja	51819	518190	PEQUEÑO	INOX	-	4	40	
	51820	518206	GRANDE	INOX	-	4	40	
Blister	92262	922621	PEQUEÑO	INOX	1	-	10	
	92263	922638	GRANDE	INOX	1	-	10	

Reversible

Acero Inoxidable

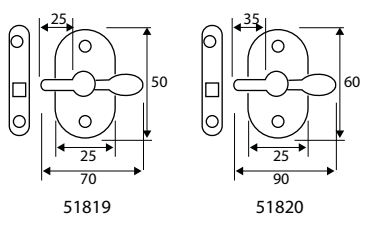

CIERRE PRESIÓN CP2

	Código	8431488	Medida	Acabado				€uros
Caja	51821	518213	105x20 mm	INOX	-	4	40	
Blister	92264	922645	105x20 mm	INOX	1	-	10	

Reversible

Acero Inoxidable

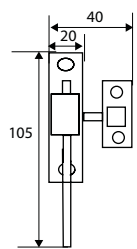

CIERRE PRESIÓN CUCHARA CP3

	Código	8431488	Medida	Acabado				€uros
Caja	51822	518220	60x15 mm	LP	-	1	5	
	51823	518237	60x15 mm	NS	-	1	5	

Reversible

Latón

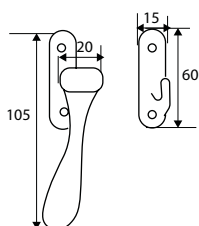

ALDABA REVERSIBLE ADB6

	Código	8431488	Medida	Acabado				€uros
Caja	51817	518176	PEQUEÑA	INOX	-	5	50	
	51818	518183	GRANDE	INOX	-	5	50	
Blister	92260	922607	PEQUEÑA	INOX	1	-	10	
	92261	922614	GRANDE	INOX	1	-	10	

Acero Inoxidable

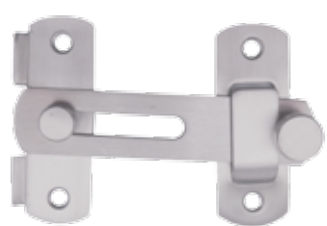
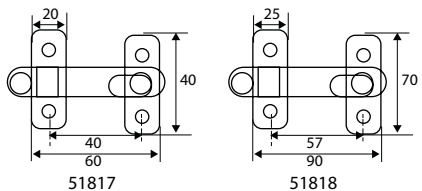

ALDABA CLÁSICA ADB1

	Código	8431488	Medida AxB/Mano	Acabado			€uros
Caja	52401	524016	40x28,5 mm/dcha	LTD	-	12	300
	52402	524023	40x28,5 mm/izda	LTD	-	12	300
	52601	526010	60x35 mm/dcha	LTD	-	12	300
	52602	526027	60x35 mm/izda	LTD	-	12	300
	52801	528014	80x45 mm/dcha	LTD	-	12	120
	52802	528021	80x45 mm/izda	LTD	-	12	120
	51401	514017	40x28,5 mm/dcha	NI	-	12	300
	51402	514024	40x28,5 mm/izda	NI	-	12	300
	51601	516011	60x35 mm/dcha	NI	-	12	300
	51602	516028	60x35 mm/izda	NI	-	12	300
	51801	518015	80x45 mm/dcha	NI	-	12	120
	51802	518022	80x45 mm/izda	NI	-	12	120
Blister	90292	902920	40x28,5 mm/dcha	LTD	1	-	10
	90293	902937	40x28,5 mm/izda	LTD	1	-	10
	90294	902944	60x35 mm/dcha	LTD	1	-	10
	90295	902951	60x35 mm/izda	LTD	1	-	10
	90296	902968	80x45 mm/dcha	LTD	1	-	10
	90297	902975	80x45 mm/izda	LTD	1	-	10
	90298	902982	40x28,5 mm/dcha	NI	1	-	10
	90299	902999	40x28,5 mm/izda	NI	1	-	10
	90300	903002	60x35 mm/dcha	NI	1	-	10
	90301	903019	60x35 mm/izda	NI	1	-	10
	90302	903026	80x45 mm/dcha	NI	1	-	10
	90303	903033	80x45 mm/izda	NI	1	-	10

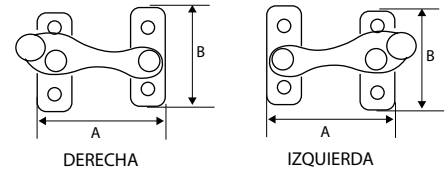

Acero

Incluye tornillos en el blister

LATONADO
 NIQUEL

ALDABA FORJA ADB4

	Código	8431488	Medida/Mano	Acabado			€uros
Caja	36021	360218	90x80 mm/dcha	NE	-	5	50
	36022	360225	90x80 mm/izda	NE	-	5	50
Blister	91518	915180	90x80 mm/dcha	NE	1	-	10
	91519	915197	90x80 mm/izda	NE	1	-	10

Acero

NEGRO

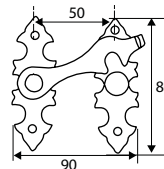

ALDABA FORJA ADB5

	Código	8431488	Medida/Mano	Acabado			€uros
Caja	36023	360232	90x65 mm	NE	-	5	50
	36024	360249	90x65 mm	NE	-	5	50
Blister	91520	915203	90x65 mm	NE	1	-	10
	91521	915210	90x65 mm	NE	1	-	10

Acero

NEGRO

Reversible

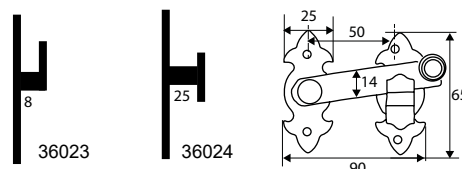



ALDABA CUÑA ADB7



	Código	8431488	Medida AxB	Acabado				€uros
Caja	51824	518244	60 mm	LS	-	4	40	
	51825	518251	60 mm	NS	-	4	40	
	51826	518268	60 mm	NE	-	4	40	
Blister	92371	923710	60 mm	LS	1	-	10	
	92372	923727	60 mm	NS	1	-	10	
	92373	923734	60 mm	NE	1	-	10	

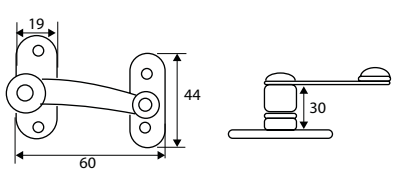

Latón

LATÓN SATINADO
 NÍQUEL SATINADO
 NEGRO

ALDABA BARCO ADB2



	Código	8431488	Medida AxBxCxD	Acabado				€uros
Caja	51808	518084	75x20x28x5,5 mm	LP	-	12	120	
	51809	518091	100x21x27x5,7 mm	LP	-	12	120	
	51810	518107	125x24x32x5,7 mm	LP	-	12	120	
	51811	518114	75x20x28x5,5 mm	NS	-	12	120	
	51812	518121	100x21x27x5,7 mm	NS	-	12	120	
	51813	518138	125x24x32x5,7 mm	NS	-	12	120	
	51814	518145	100x21x27x5,7 mm	NE	-	10	100	
	51815	518152	150x32x45x8 mm	NE	-	6	60	
Blister	91289	912899	75x20x28x5,5 mm	LP	1	-	10	
	91290	912905	100x21x27x5,7 mm	LP	1	-	10	
	91291	912912	125x24x32x5,7 mm	LP	1	-	10	
	91292	912929	75x20x28x5,5 mm	NS	1	-	10	
	91293	912936	100x21x27x5,7 mm	NS	1	-	10	
	91294	912943	125x24x32x5,7 mm	NS	1	-	10	
	91295	912950	100x21x27x5,7 mm	NE	1	-	10	

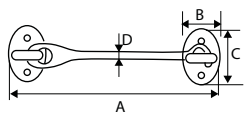

Latón

LATÓN PULIDO
 NÍQUEL SATINADO
 NEGRO

ALDABILLA RETENIDA ADB3



	Código	8431488	Medida AxB	Acabado				€uros
Caja	51803	518039	3x40 mm	ZN	-	50	250	
	51804	518046	3,5x60 mm	ZN	-	50	500	
	51805	518053	4x80 mm	ZN	-	50	500	
	51806	518060	4x100 mm	ZN	-	50	500	
	51807	518077	4,5x120 mm	ZN	-	50	250	
Blister	91191	911915	3x40 mm	ZN	1	-	10	
	91192	911922	3,5x60 mm	ZN	1	-	10	
	91193	911939	4x80 mm	ZN	1	-	10	
	91194	911946	4x100 mm	ZN	1	-	10	

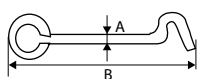

Acero

ZINCADO

PASADOR FORJA PS11

	Código	8431488	Medida AxB	Acabado				€uros
Caja	44146	441467	40x65 mm	NE	-	10	50	
	44147	441474	50x80 mm	NE	-	10	50	
Blister	91516	915166	40x65 mm	NE	1	-	10	
	91517	915173	50x80 mm	NE	1	-	10	

Acero



NEGRO

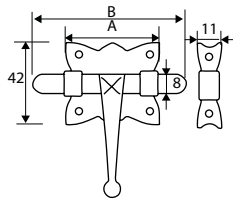

PASADOR PS2

	Código	8431488	Medida A	Acabado				€uros
Blister	44135	441351	35 mm	LTD	1	-	10	
	44235	442358	35 mm	NI	1	-	10	
	44136	441368	35 mm	NS	1	-	10	
	44137	441375	35 mm	CU	1	-	10	
	44138	441382	35 mm	LE	1	-	10	
	44139	441399	35 mm	NE	1	-	10	
	44145	441450	45 mm	LTD	1	-	10	
	44245	442457	45 mm	NI	1	-	10	
	44246	442464	45 mm	NS	1	-	10	

Zamak



Incluye tornillos en el blister

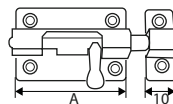

PASADOR ZAMAK PS3

	Código	8431488	Medida	Acabado				€uros
Caja	44635	446356	35 mm	LTD	-	25	250	
	44650	446509	50 mm	LTD	-	25	125	
	44735	447353	35 mm	CB	-	25	250	
	44750	447506	50 mm	CB	-	25	125	
	44633	446332	35 mm	BL	-	25	250	
	44634	446349	50 mm	BL	-	25	125	
Blister	91182	911823	35 mm	LTD	1	-	10	
	91183	911830	50 mm	LTD	1	-	10	
	91184	911847	35 mm	CB	1	-	10	
	91185	911854	50 mm	CB	1	-	10	
	91189	911892	35 mm	BL	1	-	10	
	91190	911908	50 mm	BL	1	-	10	

Zamak



Incluye tornillos en el blister

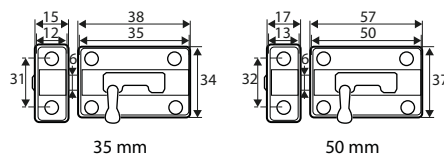



PASADOR HIERRO PS1

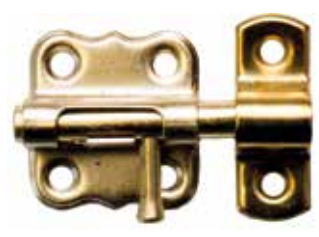

	Código	8431488	Medida AxBxC	Acabado				€uros
Caja	44330	443300	30x13x30 mm	LTD	-	25	250	
	44335	443355	35x13x35 mm	LTD	-	25	250	
	44340	443409	40x20x40 mm	LTD	-	25	250	
	44350	443508	50x25x50 mm	LTD	-	25	250	
	44360	443607	60x30x50 mm	LTD	-	25	250	
	44530	445304	30x13x30 mm	NI	-	25	250	
	44535	445359	35x13x35 mm	NI	-	25	250	
	44540	445403	40x20x40 mm	NI	-	25	250	
	44550	445502	50x25x50 mm	NI	-	25	250	
	44560	445601	60x30x50 mm	NI	-	25	250	
	44570	445700	70x35x55 mm	NI	-	10	120	
	44585	445854	85x42x58 mm	NI	-	10	60	
44510	445106	100x50x58 mm	NI	-	10	60		
Blister	90176	901763	30x13x30 mm	LTD	1	-	10	
	90177	901770	35x13x35 mm	LTD	1	-	10	
	90178	901787	40x20x40 mm	LTD	1	-	10	
	90179	901794	50x25x50 mm	LTD	1	-	10	
	90180	901800	60x30x50 mm	LTD	1	-	10	
	90171	901718	30x13x30 mm	NI	1	-	10	
	90172	901725	35x13x35 mm	NI	1	-	10	
	90173	901732	40x20x40 mm	NI	1	-	10	
	90174	901749	50x25x50 mm	NI	1	-	10	
	90175	901756	60x30x50 mm	NI	1	-	10	
91188	911885	70x35x55 mm	NI	1	-	10		

Incluye tornillos en el blister

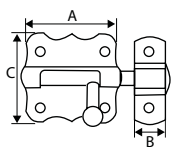

Acero
 LATONADO
 NIQUEL



PASADOR RULETA PS4

	Código	8431488	Medida	Acabado				€uros
Caja	44133	441337	40x56 mm	LTD	-	25	250	
	44134	441344	40x56 mm	CB	-	25	250	
Blister	91600	916002	40x56 mm	LTD	1	-	10	
	91601	916019	40x56 mm	CB	1	-	10	

Incluye tornillos en el blister

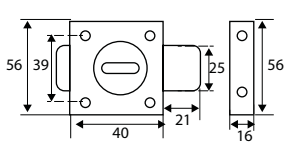

Zamak
 LATONADO
 CROMO BRILLO

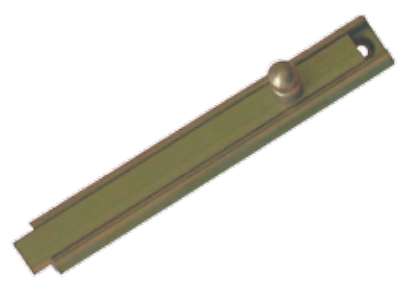

PASADOR COLA MILANO PS13

	Código	8431488	Medida AxB	Acabado				€uros
Caja	30150	301501	50x14 mm	LP	-	1	50	
	30160	301600	60x14 mm	LP	-	1	50	

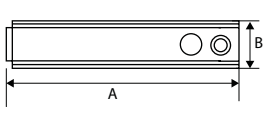

Latón
 LATÓN PULIDO

PORTACANDADO CC10

	Código	8431488	Medida A	Acabado			€uros
Caja	44986	449869	75x40 mm	ZN	-	10	100
	44987	449876	100x40 mm	ZN	-	10	100
	44988	449883	120x40 mm	ZN	-	10	50
	44989	449890	150x40 mm	ZN	-	10	30
	44990	449906	75x40 mm	NE	-	10	100
	44991	449913	100x40 mm	NE	-	10	100
	44992	449920	120x40 mm	NE	-	10	50
	44993	449937	150x40 mm	NE	-	10	30
Blister	91296	912967	75x40 mm	ZN	1	-	10
	91297	912974	100x40 mm	ZN	1	-	10
	91298	912981	120x40 mm	ZN	1	-	10
	91299	912998	75x40 mm	NE	1	-	10
	91300	913001	100x40 mm	NE	1	-	10
	91301	913018	120x40 mm	NE	1	-	10



Acero

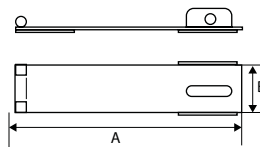

CIERRE ARCÓN CC8

	Código	8431488	Medida AxB	Acabado			€uros
Caja	36018	360188	75x85 mm	NE	-	5	50
	36019	360195	95x110 mm	NE	-	5	50
Blister	91513	915135	75x85 mm	NE	1	-	10
	91514	915142	95x110 mm	NE	1	-	10



Acero

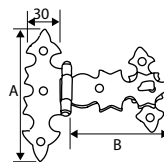

CIERRE ARCÓN CC9

	Código	8431488	Medida	Acabado			€uros
Caja	36020	360201	36x105 mm	NE	-	5	50
Blister	91515	915159	36x105 mm	NE	1	-	10



Acero

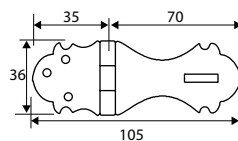

Te sugiero:

PASADORES ALUMINIO - Pág. 76-77





PASADOR PORTACANDADO PS12

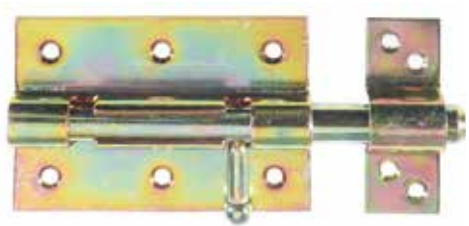

	Código	8431488	Medida AxB	Acabado				€uros
Caja	44970	449708	70x65 mm	BC	-	10	100	
	44985	449852	85x65 mm	BC	-	10	100	
	44910	449104	100x65 mm	BC	-	10	100	
	44912	449128	120x70 mm	BC	-	10	50	
Blister	90181	901817	70x65 mm	BC	1	-	10	
	90182	901824	85x65 mm	BC	1	-	10	

Incluye tornillos en el blister

Acero

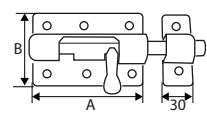

PASADOR SEGURIDAD PS6

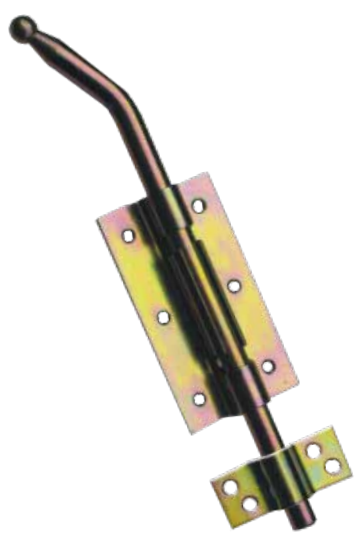

	Código	8431488	Medida AxB	Acabado				€uros
Caja	44020	440200	200x70 mm	BC	-	5	25	
	44025	440255	250x70 mm	BC	-	5	25	
	44030	440309	300x70 mm	BC	-	5	25	
	44040	440408	400x70 mm	BC	-	5	25	
	44050	440507	500x70 mm	BC	-	5	25	
	44060	440606	600x70 mm	BC	-	5	25	

Acero

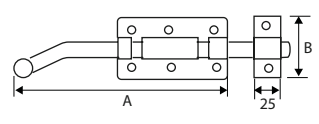

PASADOR LATÓN PS7



	Código	8431488	Medida A	Acabado				€uros
	62120	621203	200 mm	LS	-	1	-	
	62125	621258	250 mm	LS	-	1	-	
	62130	621302	300 mm	LS	-	1	-	
	62140	621401	400 mm	LS	-	1	-	
	62220	622200	200 mm	NS	-	1	-	
	62225	622255	250 mm	NS	-	1	-	
	62230	622309	300 mm	NS	-	1	-	
	62240	622408	400 mm	NS	-	1	-	
	62320	623207	200 mm	CU	-	1	-	
	62325	623252	250 mm	CU	-	1	-	
	62330	623306	300 mm	CU	-	1	-	
	62340	623405	400 mm	CU	-	1	-	

Latón

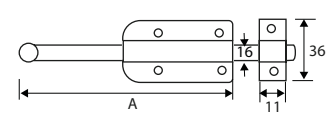

PASADOR EMBUTIR PS8

	Código	8431488	Medida A	Acabado				€uros
Caja	30015	300153	160 mm	LTD	-	24	240	
	30151	301518	160 mm	NS	-	24	240	
	30020	300207	200 mm	LTD	-	24	240	
	30201	302010	200 mm	NS	-	24	240	

Acero

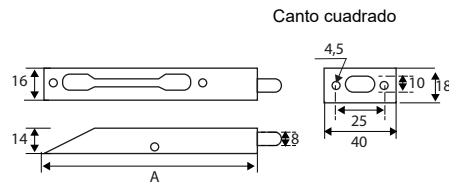

PASADOR EMBUTIR PS9

	Código	8431488	Medida A	Acabado				€uros
Caja	30155	301556	160 mm	LTD	-	24	240	
	30156	301563	160 mm	NS	-	24	240	

Acero

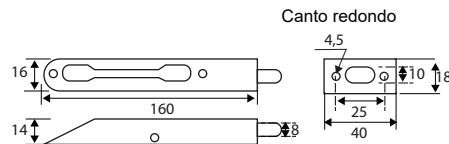

PASADOR EMBUTIR PS10

	Código	8431488	Medida AxB	Acabado				€uros
Caja	30101	301013	152x20 mm	LP	-	1	6	
	30102	301020	200x20 mm	LP	-	1	6	
	30103	301037	305x20 mm	LP	-	1	5	
	30104	301044	152x20 mm	NS	-	1	6	
	30105	301051	200x20 mm	NS	-	1	6	
	30106	301068	305x20 mm	NS	-	1	5	

Latón

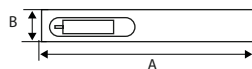

PASADOR 700

	Código	8431488	Medida AxB	Acabado				€uros
Caja	68105	681054	160x25 mm	NI	-	10	50	
	68106	681061	160x25 mm	NI	-	10	50	
	68107	681078	195x25 mm	NI	-	10	50	

Acero

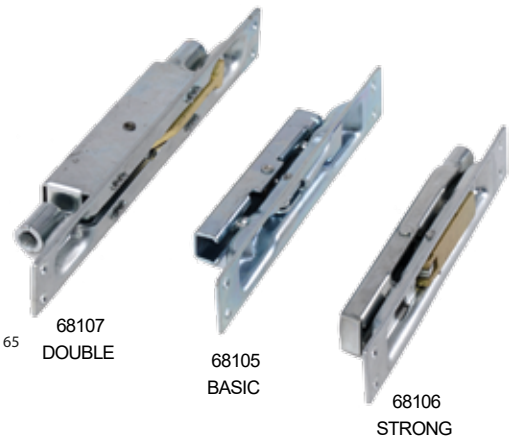
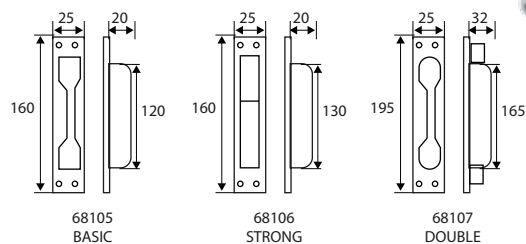

REMATE PASADOR 700

	Código	8431488	Medida	Acabado				€uros
Caja	68108	681085	M8	NI	-	10	250	

Acero

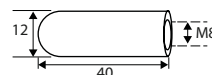



DEDAL EMBUTIR REDONDO DDL1



	Código	8431488	Medida AxB	Acabado				€uros
Caja	64008	640082	8x11,5 mm	LT	-	25	250	
	64010	640105	10x14 mm	LT	-	25	250	
	64012	640129	12x15,5 mm	LT	-	25	250	
	64014	640143	14x17,5 mm	LT	-	25	250	
	64020	640204	20x24 mm	LT	-	25	125	
	64022	640228	22x25,5 mm	LT	-	25	125	
	64108	641089	8x11,5 mm	NI	-	25	250	
	64110	641102	10x14 mm	NI	-	25	250	
	64112	641126	12x15,5 mm	NI	-	25	250	
	64114	641140	14x17,5 mm	NI	-	25	250	
	64120	641201	20x24 mm	NI	-	25	125	
	64122	641225	22x25,5 mm	NI	-	25	125	
Blister	91170	911700	8x11,5 mm	LT	1	-	10	
	91171	911717	10x14 mm	LT	1	-	10	
	91172	911724	12x15,5 mm	LT	1	-	10	
	91173	911731	14x17,5 mm	LT	1	-	10	
	91174	911748	20x24 mm	LT	1	-	10	
	91175	911755	22x25,5 mm	LT	1	-	10	
	91176	911762	8x11,5 mm	NI	1	-	10	
	91177	911779	10x14 mm	NI	1	-	10	
	91178	911786	12x15,5 mm	NI	1	-	10	
	91179	911793	14x17,5 mm	NI	1	-	10	
	91180	911809	20x24 mm	NI	1	-	10	
	91181	911816	22x25,5 mm	NI	1	-	10	

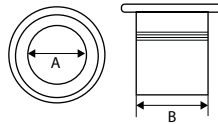

Latón
 LATÓN
 NÍQUEL

DEDAL EMBUTIR CUADRADO DDL2

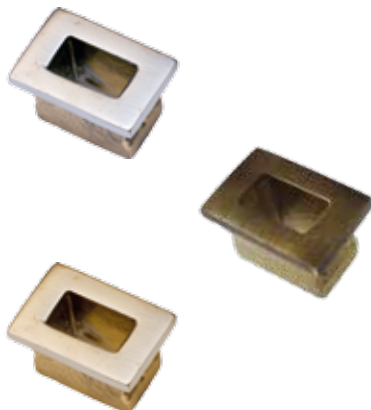

	Código	8431488	Medida	Acabado				€uros
Caja	64006	640068	34x23 mm	LP	-	5	125	
	64007	640075	34x23 mm	NS	-	5	125	
	64005	640051	34x23 mm	CU	-	5	125	
	64004	640044	34x23 mm	NE	-	5	125	

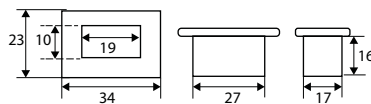

Latón
 LATÓN PULIDO
 NÍQUEL SATINADO
 CUERO
 NEGRO

SOPORTE PASAMANOS 3 TORNILLOS PMN1

	Código	8431488	Medida	Acabado				€uros
Caja	10067	100678	75x52 mm	LP	-	10	100	
	10251	106731	75x52 mm	NS	-	10	100	
	10252	106755	75x52 mm	NE	-	10	100	
Blister	90643	906430	75x52 mm	LP	1	-	10	
	90645	906454	75x52 mm	NS	1	-	10	
	90644	906447	75x52 mm	NE	1	-	10	

Latón

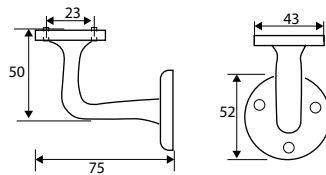

SOPORTE PASAMANOS DOWELL PMN2

	Código	8431488	Medida	Acabado				€uros
Caja	10671	106717	75x52 mm	LP	-	10	100	
	10253	106748	75x52 mm	NS	-	10	100	
	10254	106762	75x52 mm	NE	-	10	100	
Blister	90646	906461	75x52 mm	LP	1	-	10	
	90649	906492	75x52 mm	NS	1	-	10	
	90648	906485	75x52 mm	NE	1	-	10	

Latón



Incluye tornillo Dowel

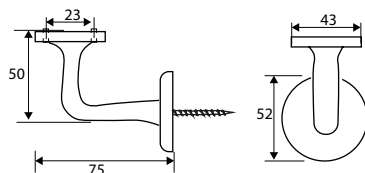

SOPORTE PASAMANOS DOWELL PMN3

	Código	8431488	Medida	Acabado				€uros
	10661	106618	70x70 mm	LTD	-	15	150	
	10663	106632	70x70 mm	NS	-	15	150	
	10662	106625	70x70 mm	NE	-	15	150	
	10664	106649	70x70 mm	CU	-	15	150	

Zamak



Incluye tornillo Dowel
Código de barras individual

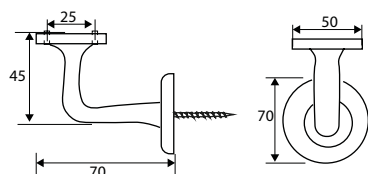



SOPORTE PASAMANOS DOWEL PMN4



	Código	8431488	Medida	Acabado				€uros
Caja	10665	106656	100x50 mm	BC	-	20	-	

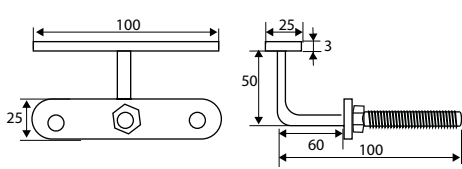

Acero

 BICROMATADO

REMATE BOLA PMN5



	Código	8431488	Medida AxBxC	Acabado				€uros
	10064	100647	43x65x31 mm	LP	-	1	4	
	10065	100654	58x100x35 mm	LP	-	1	4	
	10066	100661	70x120x40 mm	LP	-	1	4	

10064 - M8
 10065 - M10
 10066 - M10

Latón

 LATÓN PULIDO

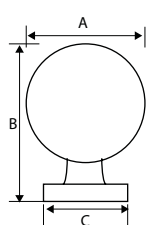

REMATE BELLOTA PMN6



	Código	8431488	Medida AxBxC	Acabado				€uros
	10069	100692	60x110x35 mm	LP	-	1	4	

M10

Latón

 LATÓN PULIDO

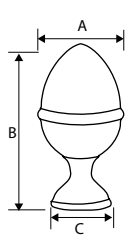

PLACA IDENTIFICATIVA "HOMBRE" PLP6

Código	8431488	Medida	Acabado				€uros
10803	108032	75 mm	INOX	-	1	-	

Acero Inoxidable

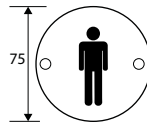

PLACA IDENTIFICATIVA "MUJER" PLP7

Código	8431488	Medida	Acabado				€uros
10804	108049	75 mm	INOX	-	1	-	

Acero Inoxidable

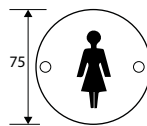

PLACA IDENTIFICATIVA "MINUSVÁLIDO" PLP9

Código	8431488	Medida	Acabado				€uros
10807	108070	75 mm	INOX	-	1	-	

Acero Inoxidable

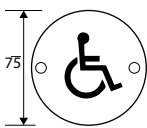

PLACA IDENTIFICATIVA "TOILETTE" PLP8

Código	8431488	Medida	Acabado				€uros
10805	108056	75 mm	INOX	-	1	-	

Acero Inoxidable

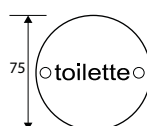



Incluye tornillos
Espesor 6 mm

Latón

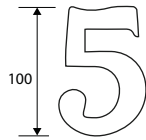

Incluye tornillos
Espesor 6 mm

Latón

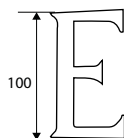

NÚMEROS NM1

Código	8431488	Medida	Acabado	Modelo				€uros
10260	102603	100 mm	LP	0	1	-	5	
10261	102610	100 mm	LP	1	1	-	5	
10262	102627	100 mm	LP	2	1	-	5	
10263	102634	100 mm	LP	3	1	-	5	
10264	102641	100 mm	LP	4	1	-	5	
10265	102658	100 mm	LP	5	1	-	5	
10266	102665	100 mm	LP	6-9	1	-	5	
10267	102672	100 mm	LP	7	1	-	5	
10268	102689	100 mm	LP	8	1	-	5	
10300	103006	100 mm	NS	0	1	-	5	
10301	103013	100 mm	NS	1	1	-	5	
10302	103020	100 mm	NS	2	1	-	5	
10303	103037	100 mm	NS	3	1	-	5	
10304	103044	100 mm	NS	4	1	-	5	
10305	103051	100 mm	NS	5	1	-	5	
10306	103068	100 mm	NS	6-9	1	-	5	
10307	103075	100 mm	NS	7	1	-	5	
10308	103082	100 mm	NS	8	1	-	5	
10280	102801	100 mm	NE	0	1	-	5	
10281	102818	100 mm	NE	1	1	-	5	
10282	102825	100 mm	NE	2	1	-	5	
10283	102832	100 mm	NE	3	1	-	5	
10284	102849	100 mm	NE	4	1	-	5	
10285	102856	100 mm	NE	5	1	-	5	
10286	102863	100 mm	NE	6-9	1	-	5	
10287	102870	100 mm	NE	7	1	-	5	
10288	102887	100 mm	NE	8	1	-	5	



Blister

LETRAS LTR1

Código	8431488	Medida	Acabado	Modelo				€uros
10271	102719	100 mm	LP	A	1	-	5	
10272	102726	100 mm	LP	B	1	-	5	
10273	102733	100 mm	LP	C	1	-	5	
10274	102740	100 mm	LP	D	1	-	5	
10275	102757	100 mm	LP	E	1	-	5	
10276	102764	100 mm	LP	F	1	-	5	
10277	102771	100 mm	LP	G	1	-	5	
10278	102788	100 mm	LP	H	1	-	5	
10330	103303	100 mm	LP	I	1	-	5	
10331	103310	100 mm	LP	J	1	-	5	
10332	103327	100 mm	LP	K	1	-	5	
10333	103334	100 mm	LP	L	1	-	5	
10334	103341	100 mm	LP	M	1	-	5	
10335	103358	100 mm	LP	N	1	-	5	
10336	103365	100 mm	LP	O	1	-	5	
10337	103372	100 mm	LP	P	1	-	5	
10338	103389	100 mm	LP	Q	1	-	5	
10339	103396	100 mm	LP	R	1	-	5	
10340	103402	100 mm	LP	S	1	-	5	
10341	103419	100 mm	LP	T	1	-	5	
10342	103426	100 mm	LP	U	1	-	5	
10343	103433	100 mm	LP	V	1	-	5	
10344	103440	100 mm	LP	W	1	-	5	
10345	103457	100 mm	LP	X	1	-	5	
10346	103464	100 mm	LP	Y	1	-	5	
10347	103471	100 mm	LP	Z	1	-	5	

Blister

LETRAS LTR1

Código	8431488	Medida	Acabado	Modelo				Euros
10311	103112	100 mm	NS	A	1	-	5	
10312	103129	100 mm	NS	B	1	-	5	
10313	103136	100 mm	NS	C	1	-	5	
10314	103143	100 mm	NS	D	1	-	5	
10315	103150	100 mm	NS	E	1	-	5	
10316	103167	100 mm	NS	F	1	-	5	
10317	103174	100 mm	NS	G	1	-	5	
10318	103181	100 mm	NS	H	1	-	5	
10366	103662	100 mm	NS	I	1	-	5	
10367	103679	100 mm	NS	J	1	-	5	
10368	103686	100 mm	NS	K	1	-	5	
10369	103693	100 mm	NS	L	1	-	5	
10370	103709	100 mm	NS	M	1	-	5	
10371	103716	100 mm	NS	N	1	-	5	
10372	103723	100 mm	NS	O	1	-	5	
10373	103730	100 mm	NS	P	1	-	5	
10374	103747	100 mm	NS	Q	1	-	5	
10375	103754	100 mm	NS	R	1	-	5	
10376	103761	100 mm	NS	S	1	-	5	
10377	103778	100 mm	NS	T	1	-	5	
10378	103785	100 mm	NS	U	1	-	5	
10379	103792	100 mm	NS	V	1	-	5	
10380	103808	100 mm	NS	W	1	-	5	
10381	103815	100 mm	NS	X	1	-	5	
10382	103822	100 mm	NS	Y	1	-	5	
10383	103839	100 mm	NS	Z	1	-	5	
10291	102917	100 mm	NE	A	1	-	5	
10292	102924	100 mm	NE	B	1	-	5	
10293	102931	100 mm	NE	C	1	-	5	
10294	102948	100 mm	NE	D	1	-	5	
10295	102955	100 mm	NE	E	1	-	5	
10296	102962	100 mm	NE	F	1	-	5	
10297	102979	100 mm	NE	G	1	-	5	
10298	102986	100 mm	NE	H	1	-	5	
10348	103488	100 mm	NE	I	1	-	5	
10349	103495	100 mm	NE	J	1	-	5	
10350	103501	100 mm	NE	K	1	-	5	
10351	103518	100 mm	NE	L	1	-	5	
10352	103525	100 mm	NE	M	1	-	5	
10353	103532	100 mm	NE	N	1	-	5	
10354	103549	100 mm	NE	O	1	-	5	
10355	103556	100 mm	NE	P	1	-	5	
10356	103563	100 mm	NE	Q	1	-	5	
10357	103570	100 mm	NE	R	1	-	5	
10358	103587	100 mm	NE	S	1	-	5	
10359	103594	100 mm	NE	T	1	-	5	
10360	103600	100 mm	NE	U	1	-	5	
10361	103617	100 mm	NE	V	1	-	5	
10362	103624	100 mm	NE	W	1	-	5	
10363	103631	100 mm	NE	X	1	-	5	
10364	103648	100 mm	NE	Y	1	-	5	
10365	103655	100 mm	NE	Z	1	-	5	

Blister



A B C D E
F G H I J K
L M N O P
Q R S T U
V W X Y Z

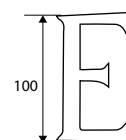

Latón



Incluye tornillos
Espesor 6 mm



PORTAETIQUETAS PTQ3



	Código	8431488	Medida AxBxCxD	Acabado				€uros
Caja	98510	985107	64x34x45x21 mm	LP	-	10	100	
	98511	985114	85x44x57x27 mm	LP	-	10	100	
	98512	985121	64x34x45x21 mm	NI	-	10	100	
	98513	985138	85x44x57x27 mm	NI	-	10	100	

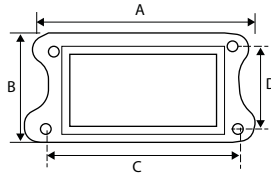

Latón
 LATÓN PULIDO
 NIQUEL

PORTAETIQUETAS PTQ4



	Código	8431488	Medida AxBxCxD	Acabado				€uros
Caja	98514	985145	55x28x41x17 mm	LP	-	10	100	
	98515	985152	77x31x59x18 mm	LP	-	10	100	
	98516	985169	102x58x80x40 mm	LP	-	10	100	
	98517	985176	55x28x41x17 mm	NI	-	10	100	
	98518	985183	77x31x59x18 mm	NI	-	10	100	
	98519	985190	102x58x80x40 mm	NI	-	10	100	

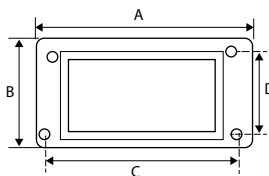

Latón
 LATÓN PULIDO
 NIQUEL

Puertas correderas





KIT PUERTA CORREDERA RÚSTICO PCR1



	Código	8431488	Medida	Acabado				€uros
Caja	55067	550671	2 mts	NE	-	1	-	
	55073	550732	2 mts	BL	-	1	-	
	55071	550718	2 mts	NS	-	1	-	
	55068	550688	2,5 mts	NE	-	1	-	
	55074	550749	2,5 mts	BL	-	1	-	
	55072	550725	2,5 mts	NS	-	1	-	

Carga máxima 80 Kg

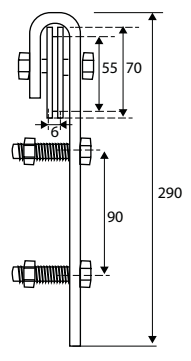

Acero



- Contenido del Kit**
- 1 Pletina (2 o 2,5 mts)
 - 2 Poleas deslizantes
 - 5 Soportes de pared
 - 2 Topes de puerta
 - 2 Tapones antidescarrilamiento
 - 1 Guía inferior
 - 1 Enganche prolongador
 - Tornillería



KIT PUERTA CORREDERA RÚSTICO PCR2

	Código	8431488	Medida	Acabado				€uros
Caja	55069	550695	2 mts	NE	-	1	-	
	55070	550701	2,5 mts	NE	-	1	-	

Carga máxima 80 Kg

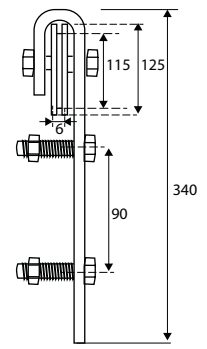

Acero



- Contenido del Kit**
- 1 Pletina (2 o 2,5 mts)
 - 2 Poleas deslizantes
 - 5 Soportes de pared
 - 2 Topes de puerta
 - 2 Enganches Soft-Closing
 - 1 Guía inferior
 - 1 Enganche prolongador
 - Tornillería



Incluye sistema soft-close

JGO TIRADOR REDONDO PCR1

	Código	8431488	Medida	Acabado				€uros
Caja	22122	221229	50 mm	NE	-	1	50	

Acero

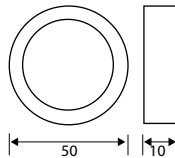

JGO MANILLÓN RECTO PCR1

	Código	8431488	Medida	Acabado				€uros
Caja	22123	221236	180 mm	NE	-	1	20	

Acero

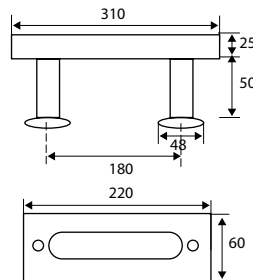

TIRADOR EMBUTIR RECTANGULAR PCR1

	Código	8431488	Medida	Acabado				€uros
Caja	22121	221212	165x54 mm	NE	-	1	50	

Acero

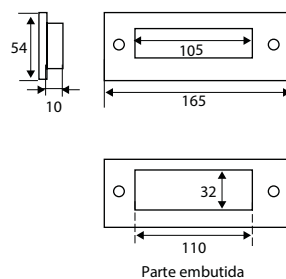



KIT PUERTA CORREDERA PCR6

	Código	8431488	Tipo	Acabado				€uros
Caja	55050	550503	p/cristal	INOX	-	1	5	
	55051	550510	p/madera	INOX	-	1	10	

Capacidad de carga de cristal: 150 kgs
No incluye el tubo

Acero Inoxidable



Contenido kit puerta de madera

1 Jgo. sujeción y rodamiento puerta 3 Soportes Tubo pared

1 Jgo. tope puerta 2 Tapones final de tubo 1 Guia carril inferior

Contenido kit puerta de cristal

1 Jgo. sujeción y rodamiento puerta 3 Soportes Tubo pared 1 Jgo. Tirador de embutir

1 Jgo. tope puerta 2 Tapones final de tubo 1 Guia carril inferior



Presentación embalaje deluxe



SOPORTE TUBO PARED LATERAL PCR6

	Código	8431488	Medida	Acabado				€uros
Caja	55052	550527	ø 25 mm	INOX	-	1	25	

Incluye tornillo, taco metálico y llave allen

Acero Inoxidable

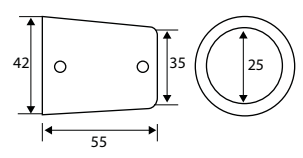

SOPORTE TUBO PARED FRONTAL PCR6

	Código	8431488	Medida	Acabado				€uros
	55066	550664	ø 25 mm	INOX	-	1	10	

Incluye tornillo y taco metálico

Acero Inoxidable

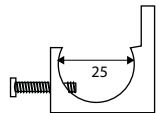
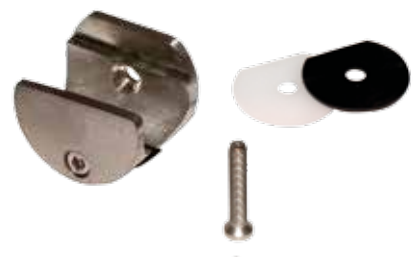

TUBO CORREDERA ø25 PCR6

	Código	8431488	Medida A	Acabado				€uros
	55060	550602	2 mts	INOX	-	1	-	
	55053	550534	3 mts	INOX	-	1	-	
	55061	550619	4 mts	INOX	-	1	-	

Espesor 2,5 mm

Acero Inoxidable

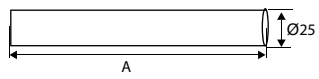

PERFIL GUÍA PCR7

	Código	8431488	Medida A	Acabado			€uros
	55056	550565	1,5 mts	AL	-	1	5
	55057	550572	2 mts	AL	-	1	5
	55058	550589	3 mts	AL	-	1	5
	55059	550596	4 mts	AL	-	1	5

Aluminio

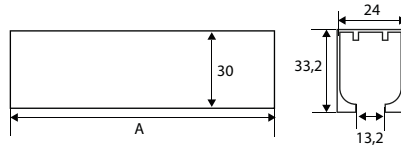

JGO ACCESORIOS P/MADERA PCR8

	Código	8431488	Peso	Acabado			€uros
Caja	55055	550558	80 KGS	RO/GR	-	1	10

ABS



Válido para el perfil guía aluminio y premarcos
Tornillo M8
Incluye tornillos de fijación

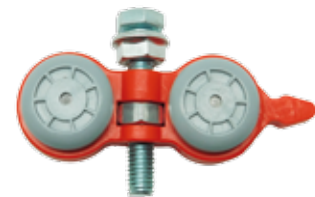
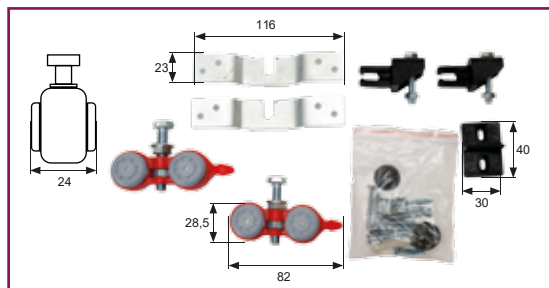

POLEA GUÍA 698

	Código	8431488	Medida Ax BxC	Acabado			€uros
	68100	681009	30x30x70 mm	BL	-	1	12
	68101	681016	35x35x110 mm	BL	-	1	6
	68102	681023	40x40x80 mm	BL	-	1	6

Nylon

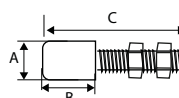



POLIPELO PCR9



Código	8431488	Medida	Acabado				€uros
55103	551036	12x2150 mm	BL	-	1	10	
55104	551043	12x2150 mm	NE	-	1	10	
55105	551050	12x2150 mm	RB	-	1	10	

Sintético

- BLANCO
- NEGRO
- ROBLE

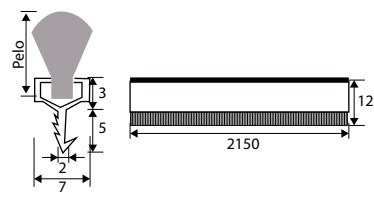

JUNTA MARCO PCR10

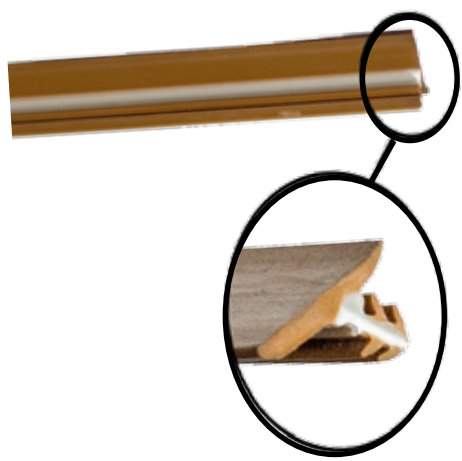

Código	8431488	Medida	Acabado				€uros
55107	551074	2150 mm	BL	-	1	10	
55108	551081	2150 mm	NE	-	1	10	
55109	551098	2150 mm	RB	-	1	10	

Goma

- BLANCO
- NEGRO
- ROBLE

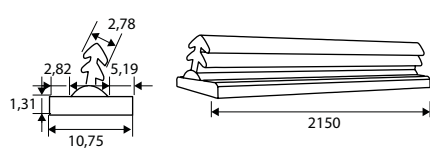

Te sugiero:



KIT PUERTA CORREDERA
Pág. 170 - 171



TIRADORES
Pág. 209



CERRADURA PICOLORO
Pág. 172