

ALUMINIO



JGO MANILLA 6800

| | Código | 8431488 | Medida | Acabado | | | | €uros |
|----------------|--------------|---------|--------|---------|---|---|----|-------|
| | 68000 | 680002 | 130 mm | BL | - | 1 | 10 | |
| | 68001 | 680019 | 130 mm | NE | - | 1 | 10 | |
| | 68002 | 680026 | 130 mm | PL | - | 1 | 10 | |
| <i>Blister</i> | 17080 | 170800 | 130 mm | BL | 1 | - | 8 | |
| | 17081 | 170817 | 130 mm | NE | 1 | - | 8 | |
| | 17082 | 170824 | 130 mm | PL | 1 | - | 8 | |

2 taladros

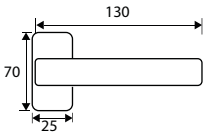

Aluminio
 BLANCO
 NEGRO
 PLATA



JGO MANILLA 6802

| | Código | 8431488 | Medida | Acabado | | | | €uros |
|----------------|--------------|---------|--------|---------|---|---|---|-------|
| | 68009 | 680095 | 120 mm | BL | - | 1 | 4 | |
| | 68010 | 680101 | 120 mm | NE | - | 1 | 4 | |
| | 68011 | 680118 | 120 mm | PL | - | 1 | 4 | |
| <i>Blister</i> | 17083 | 170831 | 120 mm | BL | 1 | - | 8 | |
| | 17084 | 170848 | 120 mm | NE | 1 | - | 8 | |
| | 17085 | 170855 | 120 mm | PL | 1 | - | 8 | |

2 taladros

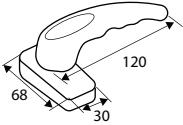

Aluminio
 BLANCO
 NEGRO
 PLATA



JGO MANILLA 6842

| | Código | 8431488 | Medida | Acabado | | | | €uros |
|----------------|--------------|---------|--------|---------|---|---|---|-------|
| | 68270 | 682709 | 120 mm | BL | - | 1 | 4 | |
| | 68271 | 682716 | 120 mm | NE | - | 1 | 4 | |
| | 68272 | 682723 | 120 mm | PL | - | 1 | 4 | |
| <i>Blister</i> | 17275 | 172750 | 120 mm | BL | 1 | - | 8 | |
| | 17276 | 172767 | 120 mm | NE | 1 | - | 8 | |
| | 17277 | 172774 | 120 mm | PL | 1 | - | 8 | |

1 taladro

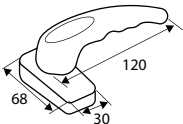

Aluminio
 BLANCO
 NEGRO
 PLATA



JGO MANILLA 6827

| | Código | 8431488 | Medida | Acabado | | | | €uros |
|---------|--------------|---------|--------|---------|---|---|---|-------|
| | 68138 | 681382 | 125 mm | BL | - | 1 | 4 | |
| | 68139 | 681399 | 125 mm | NE | - | 1 | 4 | |
| | 68140 | 681405 | 125 mm | PL | - | 1 | 4 | |
| Blister | 17142 | 171425 | 125 mm | BL | 1 | - | 8 | |
| | 17143 | 171432 | 125 mm | NE | 1 | - | 8 | |
| | 17144 | 171449 | 125 mm | PL | 1 | - | 8 | |

Aluminio

2 taladros

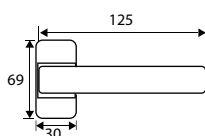
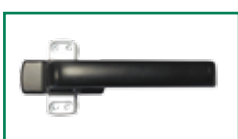

JGO MANILLA 6846

| | Código | 8431488 | Medida | Acabado | | | | €uros |
|---------|--------------|---------|--------|---------|---|---|---|-------|
| | 68189 | 681894 | 115 mm | BL | - | 1 | 4 | |
| | 68190 | 681900 | 115 mm | NE | - | 1 | 4 | |
| | 68191 | 681917 | 115 mm | PL | - | 1 | 4 | |
| Blister | 17145 | 171456 | 115 mm | BL | 1 | - | 8 | |
| | 17146 | 171463 | 115 mm | NE | 1 | - | 8 | |
| | 17147 | 171470 | 115 mm | PL | 1 | - | 8 | |

Aluminio

2 taladros

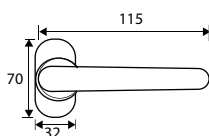
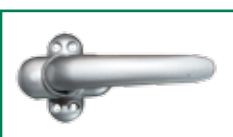

JGO MANILLA 702

| | Código | 8431488 | Medida | Acabado | | | | €uros |
|---------|--------------|---------|--------|---------|---|---|---|-------|
| | 68122 | 681221 | 120 mm | BL | - | 1 | 5 | |
| | 68123 | 681238 | 120 mm | NE | - | 1 | 5 | |
| | 68124 | 681245 | 120 mm | PL | - | 1 | 5 | |
| Blister | 17098 | 170985 | 120 mm | BL | 1 | - | 8 | |
| | 17099 | 170992 | 120 mm | NE | 1 | - | 8 | |
| | 17100 | 171005 | 120 mm | PL | 1 | - | 8 | |

Aluminio

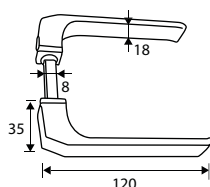

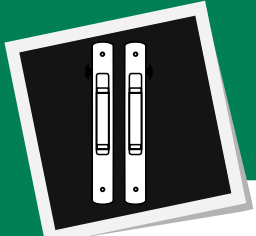

CIERRE PRESIÓN 6801



| Código | 8431488 | Mano | Acabado | | | | €uros |
|----------------|--------------|-----------|-----------|----|---|----|-------|
| 68003 | 680033 | derecha | BL | - | 1 | 10 | |
| 68004 | 680040 | izquierda | BL | - | 1 | 10 | |
| 68005 | 680057 | derecha | NE | - | 1 | 10 | |
| 68006 | 680064 | izquierda | NE | - | 1 | 10 | |
| 68007 | 680071 | derecha | PL | - | 1 | 10 | |
| 68008 | 680088 | izquierda | PL | - | 1 | 10 | |
| <i>Blister</i> | 17086 | 170862 | derecha | BL | 1 | - | 8 |
| | 17087 | 170879 | izquierda | BL | 1 | - | 8 |
| | 17088 | 170886 | derecha | NE | 1 | - | 8 |
| | 17089 | 170893 | izquierda | NE | 1 | - | 8 |
| | 17090 | 170909 | derecha | PL | 1 | - | 8 |
| 17091 | 170916 | izquierda | PL | 1 | - | 8 | |

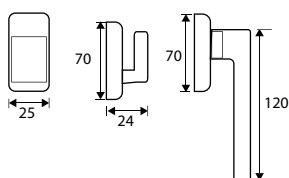

Aluminio

BLANCO NEGRO PLATA

CIERRE PRESIÓN 6858 (LLAVES IGUALES)



| Código | 8431488 | Mano | Acabado | | | | €uros |
|----------------|--------------|-----------|-----------|----|---|---|-------|
| 68312 | 683126 | derecha | BL | - | 1 | 4 | |
| 68313 | 683133 | izquierda | BL | - | 1 | 4 | |
| 68314 | 683140 | derecha | NE | - | 1 | 4 | |
| 68315 | 683157 | izquierda | NE | - | 1 | 4 | |
| <i>Blister</i> | 17284 | 172842 | derecha | BL | 1 | - | 8 |
| | 17285 | 172859 | izquierda | BL | 1 | - | 8 |
| | 17286 | 172866 | derecha | NE | 1 | - | 8 |
| | 17287 | 172873 | izquierda | NE | 1 | - | 8 |

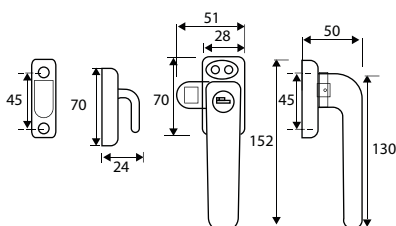

Aluminio

BLANCO NEGRO PLATA

CIERRE PRESIÓN 6864



| Código | 8431488 | Mano | Acabado | | | | €uros |
|----------------|--------------|-----------|-----------|----|---|---|-------|
| 68328 | 683287 | derecha | PL | - | 1 | 4 | |
| 68329 | 683294 | izquierda | PL | - | 1 | 4 | |
| <i>Blister</i> | 17288 | 172880 | derecha | PL | 1 | - | 8 |
| | 17289 | 172897 | izquierda | PL | 1 | - | 8 |

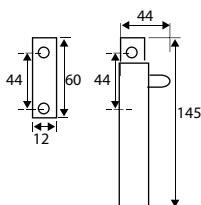

Aluminio

PLATA

CIERRE PRESIÓN 6805

| | Código | 8431488 | Mano | Acabado | | | | €uros |
|----------------|--------------|---------|-----------|---------|---|---|---|-------|
| | 68045 | 680453 | derecha | BL | - | 1 | 4 | |
| | 68046 | 680460 | izquierda | BL | - | 1 | 4 | |
| | 68047 | 680477 | derecha | NE | - | 1 | 4 | |
| | 68048 | 680484 | izquierda | NE | - | 1 | 4 | |
| | 68049 | 680491 | derecha | PL | - | 1 | 4 | |
| | 68050 | 680507 | izquierda | PL | - | 1 | 4 | |
| <i>Blister</i> | 17092 | 170923 | derecha | BL | 1 | - | 8 | |
| | 17093 | 170930 | izquierda | BL | 1 | - | 8 | |
| | 17094 | 170947 | derecha | NE | 1 | - | 8 | |
| | 17095 | 170954 | izquierda | NE | 1 | - | 8 | |
| | 17096 | 170961 | derecha | PL | 1 | - | 8 | |
| | 17097 | 170978 | izquierda | PL | 1 | - | 8 | |

Aluminio

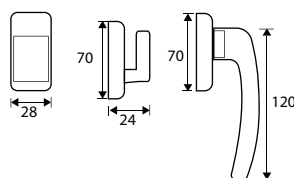

CIERRE PRESIÓN 6857

| | Código | 8431488 | Medida | Acabado | | | | €uros |
|----------------|--------------|---------|----------|---------|---|---|----|-------|
| | 68304 | 683041 | 62x17 mm | BL | - | 1 | 5 | |
| | 68305 | 683058 | 62x17 mm | NE | - | 1 | 5 | |
| <i>Blister</i> | 92296 | 922966 | 62x17 mm | BL | 1 | - | 10 | |
| | 92297 | 922973 | 62x17 mm | NE | 1 | - | 10 | |

Aluminio

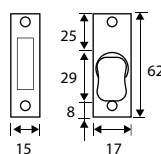

CIERRE CONTRAVENTANA 6840

| | Código | 8431488 | Medida | Acabado | | | | €uros |
|----------------|--------------|---------|----------|---------|---|---|----|-------|
| | 68177 | 681771 | 84x25 mm | BL | - | 1 | 5 | |
| | 68178 | 681788 | 84x25 mm | NE | - | 1 | 5 | |
| <i>Blister</i> | 91932 | 919324 | 84x25 mm | BL | 1 | - | 10 | |
| | 91933 | 919331 | 84x25 mm | NE | 1 | - | 10 | |

Aluminio

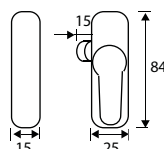

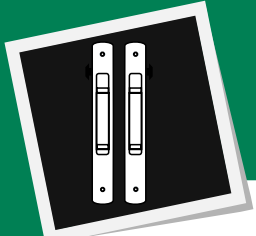

JGO MANILLA CIEGA 6824

| | Código | 843 I 488 | Medida | Acabado | | | | €uros |
|---------|--------------|-----------|-----------|---------|---|---|----|-------|
| Caja | 68306 | 683065 | 225x30 mm | BL | - | 1 | 10 | |
| | 68307 | 683072 | 225x30 mm | NE | - | 1 | 10 | |
| Blister | 17278 | 172781 | 225x30 mm | BL | 1 | - | 8 | |
| | 17279 | 172798 | 225x30 mm | NE | 1 | - | 8 | |

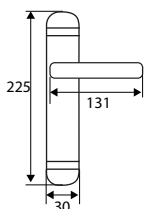

Aluminio



JGO MANILLA C/BOCALLAVE 6824

| | Código | 843 I 488 | Medida | Acabado | | | | €uros |
|---------|--------------|-----------|-----------|---------|---|---|----|-------|
| Caja | 68069 | 680699 | 225x30 mm | BL | - | 1 | 10 | |
| | 68070 | 680705 | 225x30 mm | NE | - | 1 | 10 | |
| Blister | 17101 | 171012 | 225x30 mm | BL | 1 | - | 8 | |
| | 17102 | 171029 | 225x30 mm | NE | 1 | - | 8 | |

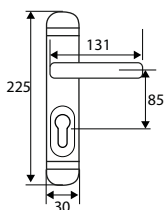

Aluminio



ASA PLACA CIEGA 6843

| | Código | 843 I 488 | Medida | Acabado | | | | €uros |
|---------|--------------|-----------|-----------|---------|---|---|---|-------|
| | 68308 | 683089 | 225x30 mm | BL | - | 1 | 2 | |
| | 68309 | 683096 | 225x30 mm | NE | - | 1 | 2 | |
| Blister | 17280 | 172804 | 225x30 mm | BL | 2 | - | 8 | |
| | 17281 | 172811 | 225x30 mm | NE | 2 | - | 8 | |



Precio unitario

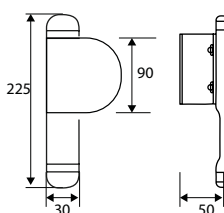

Aluminio



ASA PLACA C/BOCALLAVE 6843

| | Código | 8431488 | Medida | Acabado | | | | €uros |
|---------|--------------|---------|-----------|---------|---|---|---|-------|
| | 68183 | 681832 | 225x30 mm | BL | - | 1 | 2 | |
| | 68184 | 681849 | 225x30 mm | NE | - | 1 | 2 | |
| Blister | 17150 | 171500 | 225x30 mm | BL | 2 | - | 8 | |
| | 17151 | 171517 | 225x30 mm | NE | 2 | - | 8 | |

Aluminio

Precio unitario

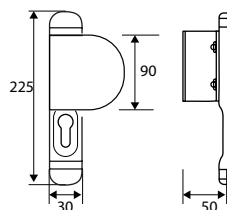

JGO POMO PLACA CIEGA 6844

| | Código | 8431488 | Medida | Acabado | | | | €uros |
|---------|--------------|---------|-----------|---------|---|---|----|-------|
| Caja | 68310 | 683102 | 225x30 mm | BL | - | 1 | 10 | |
| | 68311 | 683119 | 225x30 mm | NE | - | 1 | 10 | |
| Blister | 17282 | 172828 | 225x30 mm | BL | 1 | - | 8 | |
| | 17283 | 172835 | 225x30 mm | NE | 1 | - | 8 | |

Aluminio

Precio juego (2 uds)

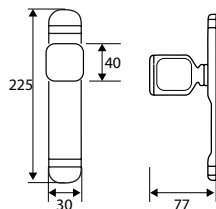

JGO POMO PLACA C/BOCALLAVE 6844

| | Código | 8431488 | Medida | Acabado | | | | €uros |
|---------|--------------|---------|-----------|---------|---|---|----|-------|
| Caja | 68185 | 681856 | 225x30 mm | BL | - | 1 | 10 | |
| | 68186 | 681863 | 225x30 mm | NE | - | 1 | 10 | |
| Blister | 17148 | 171487 | 225x30 mm | BL | 1 | - | 8 | |
| | 17149 | 171494 | 225x30 mm | NE | 1 | - | 8 | |

Aluminio

Precio juego (2 uds)

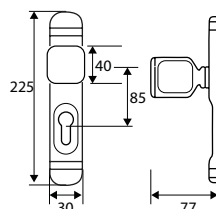

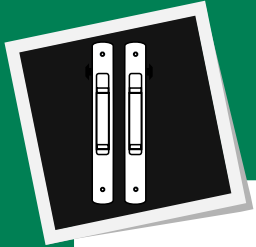

JGO POMO RECUPERABLE 6807



| Código | 8431488 | Medida | Acabado | | | | €uros |
|---------|--------------|--------|----------|----|---|---|-------|
| | 68012 | 680125 | 80x39 mm | BL | - | 1 | 10 |
| | 68013 | 680132 | 80x39 mm | NE | - | 1 | 10 |
| | 68014 | 680149 | 80x39 mm | PL | - | 1 | 10 |
| Blíster | 17103 | 171036 | 80x39 mm | BL | 1 | - | 8 |
| | 17104 | 171043 | 80x39 mm | NE | 1 | - | 8 |
| | 17105 | 171050 | 80x39 mm | PL | 1 | - | 8 |

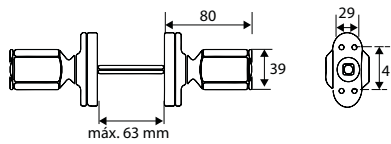

Aluminio

ASA PLACA RECTA 6804



| Código | 8431488 | Medida | Acabado | | | | €uros |
|---------|--------------|--------|---------|----|---|---|-------|
| | 68018 | 680187 | 200 mm | BL | - | 1 | 5 |
| | 68019 | 680194 | 200 mm | NE | - | 1 | 5 |
| | 68020 | 680200 | 200 mm | PL | - | 1 | 5 |
| Blíster | 17106 | 171067 | 200 mm | BL | 2 | - | 8 |
| | 17107 | 171074 | 200 mm | NE | 2 | - | 8 |
| | 17108 | 171081 | 200 mm | PL | 2 | - | 8 |

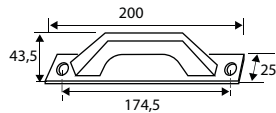

Aluminio

ASA RECTA S/PLACA 6804



| Código | 8431488 | Medida | Acabado | | | | €uros |
|---------|--------------|--------|---------|----|---|---|-------|
| | 68279 | 682792 | 152 mm | BL | - | 1 | 5 |
| | 68280 | 682808 | 152 mm | NE | - | 1 | 5 |
| | 68281 | 682815 | 152 mm | PL | - | 1 | 5 |
| Blíster | 92281 | 922812 | 152 mm | BL | 1 | - | 10 |
| | 92282 | 922829 | 152 mm | NE | 1 | - | 10 |
| | 92283 | 922836 | 152 mm | PL | 1 | - | 10 |

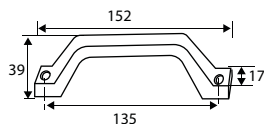

Aluminio

ASA PLACA REDONDA 6803

| | Código | 8431488 | Medida | Acabado | | | | €uros |
|----------------|--------------|---------|--------|---------|---|---|---|-------|
| | 68015 | 680156 | 200 mm | BL | - | 1 | 5 | |
| | 68016 | 680163 | 200 mm | NE | - | 1 | 5 | |
| | 68017 | 680170 | 200 mm | PL | - | 1 | 5 | |
| <i>Blister</i> | 17109 | 171098 | 200 mm | BL | 2 | - | 8 | |
| | 17110 | 171104 | 200 mm | NE | 2 | - | 8 | |
| | 17111 | 171111 | 200 mm | PL | 2 | - | 8 | |

Aluminio

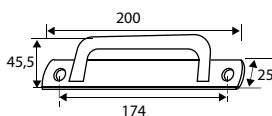

ASA CORREDERA 6809

| | Código | 8431488 | Medida | Acabado | | | | €uros |
|----------------|--------------|---------|--------|---------|---|---|----|-------|
| | 68024 | 680248 | 173 mm | BL | - | 1 | 5 | |
| | 68025 | 680255 | 173 mm | NE | - | 1 | 5 | |
| | 68026 | 680262 | 173 mm | PL | - | 1 | 5 | |
| <i>Blister</i> | 17292 | 172927 | 173 mm | BL | 1 | - | 10 | |
| | 17293 | 172934 | 173 mm | NE | 1 | - | 10 | |
| | 17294 | 172941 | 173 mm | PL | 1 | - | 10 | |

Aluminio

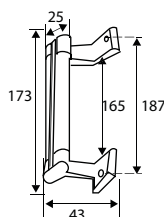

ALUMINIO

ASA CORREDERA 6862

| | Código | 8431488 | Medida | Acabado | | | | €uros |
|--|--------------|---------|--------|---------|---|---|---|-------|
| | 68297 | 682976 | 97 mm | BL | - | 1 | 5 | |
| | 68298 | 682983 | 97 mm | NE | - | 1 | 5 | |
| | 68299 | 682990 | 97 mm | PL | - | 1 | 5 | |

Aluminio

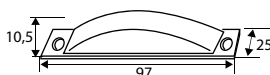

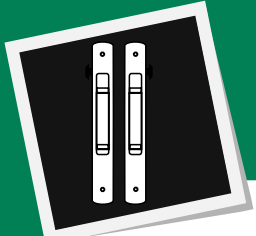

ASA CIERRE OVAL 6849

| | Código | 8431488 | Medida | Acabado | | | | €uros |
|--|--------------|---------|--------|---------|---|---|---|-------|
| | 68275 | 682754 | 205 mm | BL | - | 1 | 5 | |
| | 68276 | 682761 | 205 mm | NE | - | 1 | 5 | |
| | 68341 | 683416 | 205 mm | PL | - | 1 | 5 | |

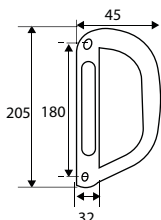

Aluminio



CIERRE CORREDERA 6820

| | Código | 8431488 | Medida | Acabado | | | | €uros |
|----------------|--------------|---------|-----------|---------|---|---|----|-------|
| | 68061 | 680613 | 174x24 mm | BL | - | 2 | 10 | |
| | 68062 | 680620 | 174x24 mm | NE | - | 2 | 10 | |
| <i>Blister</i> | 91802 | 918020 | 174x24 mm | BL | 2 | - | 10 | |
| | 91803 | 918037 | 174x24 mm | NE | 2 | - | 10 | |

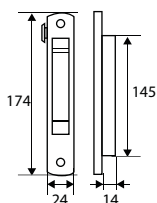

Aluminio



Incluye cerradero

CIERRE CORREDERA 6845

| | Código | 8431488 | Medida | Acabado | | | | €uros |
|----------------|--------------|---------|-----------|---------|---|---|----|-------|
| | 68187 | 681870 | 185x29 mm | BL | - | 2 | 10 | |
| | 68188 | 681887 | 185x29 mm | NE | - | 2 | 10 | |
| <i>Blister</i> | 91966 | 919669 | 185x29 mm | BL | 2 | - | 10 | |
| | 91967 | 919676 | 185x29 mm | NE | 2 | - | 10 | |

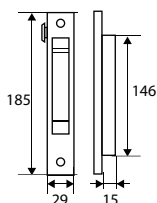

Aluminio



Incluye cerradero

CIERRE CORREDERA 6821

| | Código | 8431488 | Medida | Acabado | | | | €uros |
|----------------|--------------|---------|-----------|---------|---|---|----|-------|
| | 68063 | 680637 | 174x24 mm | BL | - | 2 | 10 | |
| | 68064 | 680644 | 174x24 mm | NE | - | 2 | 10 | |
| <i>Blister</i> | 91804 | 918044 | 174x24 mm | BL | 2 | - | 10 | |
| | 91805 | 918051 | 174x24 mm | NE | 2 | - | 10 | |

Aluminio

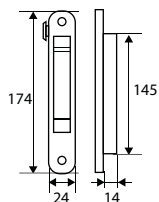

Incluye cerradero

CIERRE CORREDERA 6822

| | Código | 8431488 | Medida | Acabado | | | | €uros |
|----------------|--------------|---------|-----------|---------|---|---|----|-------|
| | 68065 | 680651 | 174x24 mm | BL | - | 2 | 10 | |
| | 68066 | 680668 | 174x24 mm | NE | - | 2 | 10 | |
| <i>Blister</i> | 91806 | 918068 | 174x24 mm | BL | 2 | - | 10 | |
| | 91807 | 918075 | 174x24 mm | NE | 2 | - | 10 | |

Aluminio

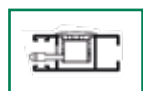
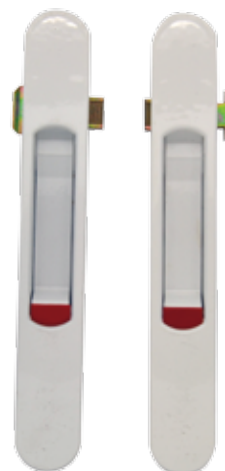
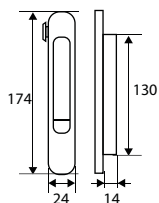

Incluye cerradero

CIERRE CORREDERA 6823

| | Código | 8431488 | Medida | Acabado | | | | €uros |
|----------------|--------------|---------|-----------|---------|---|---|----|-------|
| | 68067 | 680675 | 167x24 mm | BL | - | 2 | 10 | |
| | 68068 | 680682 | 167x24 mm | NE | - | 2 | 10 | |
| <i>Blister</i> | 91808 | 918082 | 167x24 mm | BL | 2 | - | 10 | |
| | 91809 | 918099 | 167x24 mm | NE | 2 | - | 10 | |

Aluminio

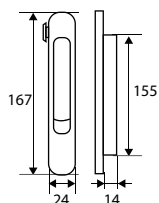

Incluye cerradero

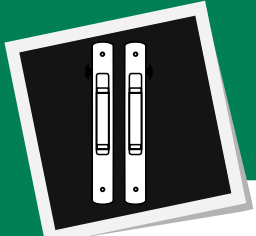

CIERRE CORREDERA PLÁSTICO 6836



| | Código | 8431488 | Medida | Acabado | | | | €uros |
|----------------|--------------|---------|-----------|---------|---|---|----|-------|
| | 68163 | 681634 | 165x26 mm | BL | - | 2 | 10 | |
| | 68164 | 681641 | 165x26 mm | NE | - | 2 | 10 | |
| <i>Blister</i> | 91958 | 919584 | 165x26 mm | BL | 2 | - | 10 | |
| | 91959 | 919591 | 165x26 mm | NE | 2 | - | 10 | |

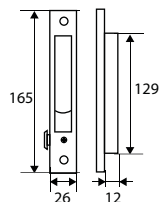

Nylon
 BLANCO
 NEGRO



CIERRE CORREDERA 6859 (LLAVES IGUALES)



| | Código | 8431488 | Medida | Acabado | | | | €uros |
|----------------|--------------|---------|-----------|---------|---|---|----|-------|
| | 68316 | 683164 | 206x25 mm | BL | - | 1 | 5 | |
| | 68317 | 683171 | 206x25 mm | NE | - | 1 | 5 | |
| <i>Blister</i> | 92298 | 922980 | 206x25 mm | BL | 2 | - | 10 | |
| | 92299 | 922997 | 206x25 mm | NE | 2 | - | 10 | |

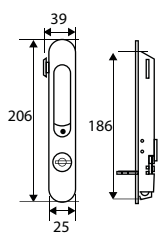

Aluminio
 BLANCO
 NEGRO

CIERRE CORREDERA 6826 (LLAVES IGUALES)



| | Código | 8431488 | Medida | Acabado | | | | €uros |
|----------------|--------------|---------|-----------|---------|---|---|----|-------|
| | 68135 | 681351 | 120x29 mm | BL | - | 1 | 5 | |
| | 68136 | 681368 | 120x29 mm | NE | - | 1 | 5 | |
| <i>Blister</i> | 92169 | 921693 | 120x29 mm | BL | 1 | - | 10 | |
| | 92170 | 921709 | 120x29 mm | NE | 1 | - | 10 | |

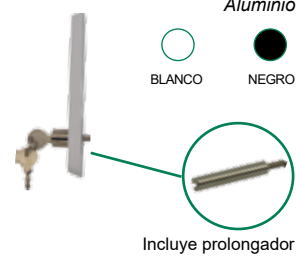
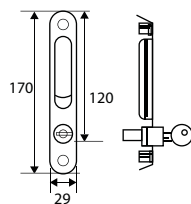

Aluminio
 BLANCO
 NEGRO

PROLONGADOR CIERRE CORREDERA 6826



| | Código | 8431488 | Medida | Acabado | | | | €uros |
|------|--------------|---------|--------|---------|---|----|-----|-------|
| Caja | 68137 | 681375 | 36 mm | NI | - | 10 | 250 | |

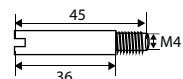

Acero
 NIQUEL

CERRADERO LENGÜETA 6818

| | Código | 8431488 | Tipo | Acabado | | | €uros |
|---------|--------|---------|----------------------|---------|---|----|-------|
| Caja | 68032 | 680323 | abierto | ZN | - | 25 | 625 |
| | 68071 | 680712 | doble desplazamiento | ZN | - | 25 | 625 |
| | 68059 | 680590 | 30x20 mm | ZN | - | 25 | 625 |
| | 68060 | 680606 | 36x20 mm | ZN | - | 25 | 625 |
| Blister | 91964 | 919645 | abierto | ZN | 2 | - | 10 |
| | 91965 | 919652 | doble desplazamiento | ZN | 2 | - | 10 |
| | 91487 | 914879 | 30x20 mm | ZN | 2 | - | 10 |
| | 91488 | 914886 | 36x20 mm | ZN | 2 | - | 10 |



KIT CERRADERO LENGÜETA 6818

| | Código | 8431488 | Acabado | | | | €uros |
|---------|--------|---------|---------|---|---|----|--------|
| Blister | 92280 | 922805 | ZN | 4 | - | 10 | 3,9500 |



Zamak



Incluye:

- 1 ud - 68059 -CERRADERO LENGÜETA 6818-22 ZN
- 1 ud - 68060 -CERRADERO LENGÜETA 6818-25 ZN
- 1 ud - 68032 -CERRADERO LENGÜETA 6818-01 ZN
- 1 ud - 68071 -CERRADERO LENGÜETA 6818-02 ZN

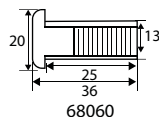
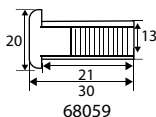
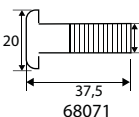
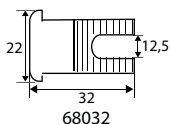

CONTRACIERRE 6819

| | Código | 8431488 | Medida | Acabado | | | €uros |
|---------|--------|---------|--------------|---------|---|----|-------|
| Caja | 68128 | 681283 | 32 mm | ZN | - | 25 | 625 |
| | 68129 | 681290 | 54 mm | ZN | - | 25 | 250 |
| | 68130 | 681306 | 30 mm | ZN | - | 25 | 625 |
| | 68131 | 681313 | 35 mm | BC | - | 25 | 625 |
| | 68165 | 681658 | 38,9x11,9 mm | NE | - | 25 | 625 |
| | 68166 | 681665 | 33x8,5 mm | ZN | - | 25 | 625 |
| | 68167 | 681672 | 49,5x7x6 mm | ZN | - | 25 | 625 |
| | 68168 | 681689 | 49,5x7x8 mm | ZN | - | 25 | 625 |
| Blister | 91483 | 914831 | 32 mm | ZN | 2 | - | 10 |
| | 91484 | 914848 | 54 mm | ZN | 2 | - | 10 |
| | 91485 | 914855 | 30 mm | ZN | 2 | - | 10 |
| | 91486 | 914862 | 35 mm | BC | 2 | - | 10 |
| | 91960 | 919607 | 38,9x11,9 mm | NE | 2 | - | 10 |
| | 91961 | 919614 | 33x8,5 mm | ZN | 2 | - | 10 |
| | 91962 | 919621 | 49,5x7x6 mm | ZN | 2 | - | 10 |
| | 91963 | 919638 | 49,5x7x8 mm | ZN | 2 | - | 10 |

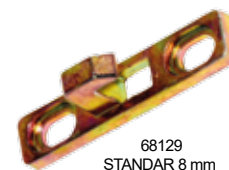

KIT CONTRACIERRE 6819

| | Código | 8431488 | Acabado | | | | €uros |
|---------|--------|---------|---------|---|---|----|--------|
| Blister | 92279 | 922799 | BC/ZN | 4 | - | 10 | 3,6500 |



Zamak



Incluye:

- 1 ud - 68128 -CONTRACIERRE 6819-01 ZN
- 1 ud - 68129 -CONTRACIERRE 6819-02 ZN
- 1 ud - 68130 -CONTRACIERRE 6819-05 ZN
- 1 ud - 68131 -CONTRACIERRE 6819-12 BC

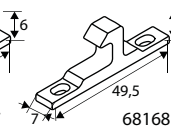
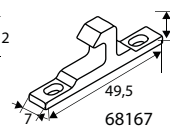
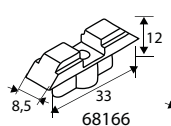
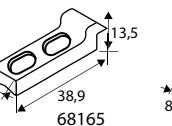
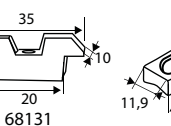
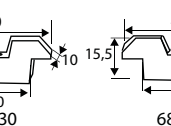
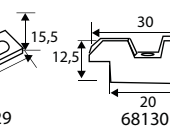
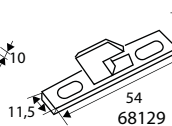
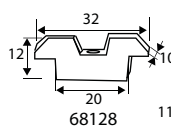

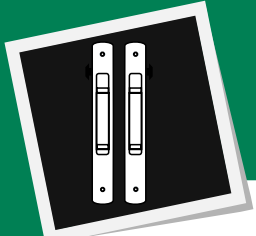

CIERRE CORREDERA PULSAR 6841

| Código | 8431488 | Medida | Acabado | | | | €uros |
|---------|--------------|--------|-----------|----|---|---|-------|
| | 68179 | 681795 | 172x19 mm | BL | - | 1 | 5 |
| | 68180 | 681801 | 172x19 mm | NE | - | 1 | 5 |
| Blister | 92129 | 921297 | 172x19 mm | BL | 1 | - | 10 |
| | 91937 | 919379 | 172x19 mm | NE | 1 | - | 10 |

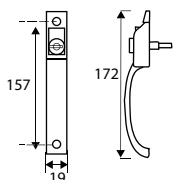

Aluminio



CIERRE CORREDERA 6841 (LLAVES IGUALES)

| Código | 8431488 | Medida | Acabado | | | | €uros |
|---------|--------------|--------|-----------|----|---|---|-------|
| | 68181 | 681818 | 172x19 mm | BL | - | 1 | 5 |
| | 68182 | 681825 | 172x19 mm | NE | - | 1 | 5 |
| Blister | 91938 | 919386 | 172x19 mm | BL | 1 | - | 10 |
| | 91939 | 919393 | 172x19 mm | NE | 1 | - | 10 |

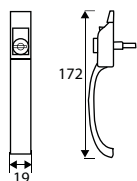

Aluminio



CIERRE CORREDERA 6847 (LLAVES IGUALES)

| Código | 8431488 | Medida | Acabado | | | | €uros |
|---------|--------------|--------|-----------|----|---|---|-------|
| | 68192 | 681924 | 147x26 mm | BL | - | 1 | 5 |
| | 68193 | 681931 | 147x26 mm | NE | - | 1 | 5 |
| Blister | 91934 | 919348 | 147x26 mm | BL | 1 | - | 10 |
| | 91935 | 919355 | 147x26 mm | NE | 1 | - | 10 |

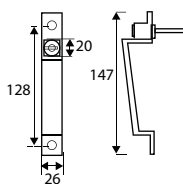

Aluminio



CIERRE CORREDERA PULSAR 6865

| Código | 8431488 | Medida | Acabado | | | | €uros |
|---------|--------------|--------|-----------|----|---|---|-------|
| | 68330 | 683300 | 135x17 mm | BL | - | 1 | 5 |
| | 68331 | 683317 | 135x17 mm | NE | - | 1 | 5 |
| | 68332 | 683324 | 135x17 mm | PL | - | 1 | 5 |
| Blister | 92327 | 923277 | 135x17 mm | BL | 1 | - | 10 |
| | 92328 | 923284 | 135x17 mm | NE | 1 | - | 10 |
| | 92329 | 923291 | 135x17 mm | PL | 1 | - | 10 |

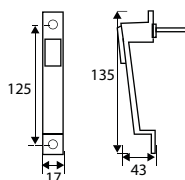

Aluminio



BISAGRA SERIE EUROPEA 6812

| Código | 8431488 | Mano | Acabado | | | | €uros |
|----------------|--------------|-----------|-----------|----|---|----|-------|
| 68033 | 680330 | derecha | BL | - | 2 | 10 | |
| 68034 | 680347 | izquierda | BL | - | 2 | 10 | |
| 68035 | 680354 | derecha | NE | - | 2 | 10 | |
| 68036 | 680361 | izquierda | NE | - | 2 | 10 | |
| 68037 | 680378 | derecha | PL | - | 2 | 10 | |
| 68038 | 680385 | izquierda | PL | - | 2 | 10 | |
| <i>BliSter</i> | 91471 | 914718 | derecha | BL | 2 | - | 10 |
| | 91472 | 914725 | izquierda | BL | 2 | - | 10 |
| | 91473 | 914732 | derecha | NE | 2 | - | 10 |
| | 91474 | 914749 | izquierda | NE | 2 | - | 10 |
| | 91475 | 914756 | derecha | PL | 2 | - | 10 |
| | 91476 | 914763 | izquierda | PL | 2 | - | 10 |

Aluminio

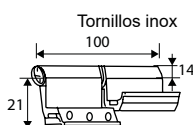

BISAGRA SERIE 40/20 6813

| Código | 8431488 | Mano | Acabado | | | | €uros |
|----------------|--------------|-----------|-----------|----|---|----|-------|
| 68039 | 680392 | derecha | BL | - | 2 | 10 | |
| 68040 | 680408 | izquierda | BL | - | 2 | 10 | |
| 68041 | 680415 | derecha | NE | - | 2 | 10 | |
| 68042 | 680422 | izquierda | NE | - | 2 | 10 | |
| 68043 | 680439 | derecha | PL | - | 2 | 10 | |
| 68044 | 680446 | izquierda | PL | - | 2 | 10 | |
| <i>BliSter</i> | 91477 | 914770 | derecha | BL | 2 | - | 10 |
| | 91478 | 914787 | izquierda | BL | 2 | - | 10 |
| | 91479 | 914794 | derecha | NE | 2 | - | 10 |
| | 91480 | 914800 | izquierda | NE | 2 | - | 10 |
| | 91481 | 914817 | derecha | PL | 2 | - | 10 |
| | 91482 | 914824 | izquierda | PL | 2 | - | 10 |

Aluminio

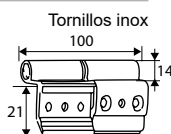

BISAGRA SERIE 40/20 6813

BISAGRA 3 NUDOS SERIE EUROPEA 6868

| Código | 8431488 | Medida | Acabado | | | | €uros |
|--------------|---------|-----------|---------|---|---|----|-------|
| 68342 | 683423 | 100x25 mm | BL | - | 1 | 10 | |
| 68343 | 683430 | 100x25 mm | NE | - | 1 | 10 | |

Aluminio

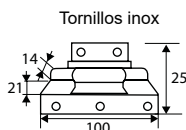

BISAGRA 3 NUDOS SERIE EUROPEA 6868

BISAGRA 3 CUERPOS SERIE 40/20 6867

| Código | 8431488 | Medida | Acabado | | | | €uros |
|--------------|---------|-----------|---------|---|---|---|-------|
| 68277 | 682778 | 150x45 mm | BL | - | 1 | 5 | |
| 68278 | 682785 | 150x45 mm | NE | - | 1 | 5 | |

Aluminio

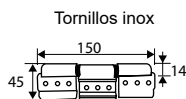

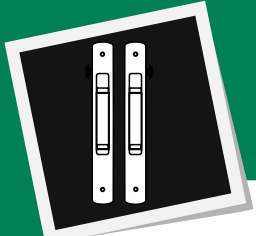

MANILLA MULTIPUNTO 6806

| Código | 843 I 488 | Medida | Acabado | | | | €uros |
|--------------|-----------|-----------|---------|---|---|---|-------|
| 68030 | 680309 | 140x30 mm | BL | - | 1 | 4 | |
| 68031 | 680316 | 140x30 mm | NE | - | 1 | 4 | |

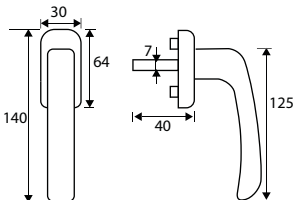

Aluminio



MANILLA MULTIPUNTO 6806 (LLAVES IGUALES)

| Código | 843 I 488 | Medida | Acabado | | | | €uros |
|--------------|-----------|-----------|---------|---|---|---|-------|
| 68273 | 682730 | 150x30 mm | BL | - | 1 | 4 | |
| 68274 | 682747 | 150x30 mm | NE | - | 1 | 4 | |

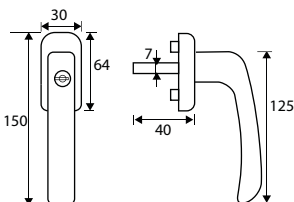

Aluminio



MANILLA MULTIPUNTO 6855

| Código | 843 I 488 | Medida | Acabado | | | | €uros |
|--------------|-----------|-----------|---------|---|---|---|-------|
| 68300 | 683003 | 200x30 mm | BL | - | 1 | 4 | |
| 68301 | 683010 | 200x30 mm | NE | - | 1 | 4 | |

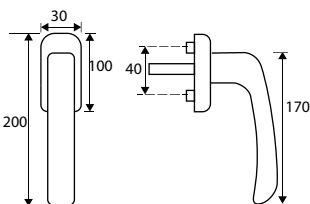

Aluminio



MANILLA FACHADA 6848

| Código | 843 I 488 | Mano | Acabado | | | | €uros |
|--------------|-----------|-----------|---------|---|---|---|-------|
| 68194 | 681948 | derecha | BL | - | 1 | 4 | |
| 68195 | 681955 | izquierda | BL | - | 1 | 4 | |
| 68196 | 681962 | derecha | NE | - | 1 | 4 | |
| 68197 | 681979 | izquierda | NE | - | 1 | 4 | |
| 68198 | 681986 | derecha | PL | - | 1 | 4 | |
| 68199 | 681993 | izquierda | PL | - | 1 | 4 | |

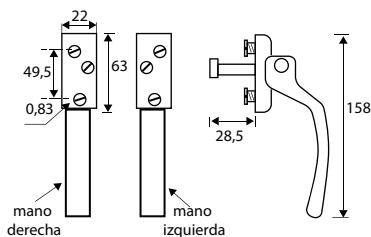

Aluminio



CREMONA 6816

| | Código | 8431488 | Medida | Acabado | | | | €uros |
|----------------|--------------|---------|-------------|---------|---|---|----|-------|
| | 68055 | 680552 | 170,5x25 mm | BL | - | 1 | 5 | |
| | 68056 | 680569 | 170,5x25 mm | NE | - | 1 | 5 | |
| <i>Blister</i> | 91814 | 918143 | 170,5x25 mm | BL | 1 | - | 10 | |
| | 91815 | 918150 | 170,5x25 mm | NE | 1 | - | 10 | |

Aluminio

2 patillas

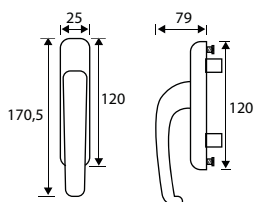

CREMONA 6817

| | Código | 8431488 | Medida | Acabado | | | | €uros |
|----------------|--------------|---------|-----------|---------|---|---|----|-------|
| | 68057 | 680576 | 180x34 mm | BL | - | 1 | 5 | |
| | 68058 | 680583 | 180x34 mm | NE | - | 1 | 5 | |
| <i>Blister</i> | 91816 | 918167 | 180x34 mm | BL | 1 | - | 10 | |
| | 91817 | 918174 | 180x34 mm | NE | 1 | - | 10 | |

Aluminio

2 patillas

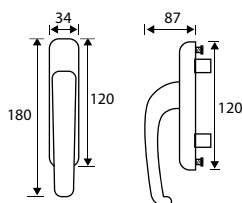

CREMONA 6814

| | Código | 8431488 | Medida | Acabado | | | | €uros |
|----------------|--------------|---------|-----------|---------|---|---|----|-------|
| | 68051 | 680514 | 160x29 mm | BL | - | 1 | 5 | |
| | 68052 | 680521 | 160x29 mm | NE | - | 1 | 5 | |
| <i>Blister</i> | 91810 | 918105 | 160x29 mm | BL | 1 | - | 10 | |
| | 91811 | 918112 | 160x29 mm | NE | 1 | - | 10 | |

Aluminio

2 patillas

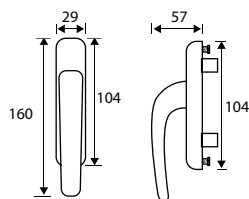

CREMONA 6815

| | Código | 8431488 | Medida | Acabado | | | | €uros |
|----------------|--------------|---------|-------------|---------|---|---|----|-------|
| | 68053 | 680538 | 173,5x34 mm | BL | - | 1 | 5 | |
| | 68054 | 680545 | 173,5x34 mm | NE | - | 1 | 5 | |
| <i>Blister</i> | 91812 | 918129 | 173,5x34 mm | BL | 1 | - | 10 | |
| | 91813 | 918136 | 173,5x34 mm | NE | 1 | - | 10 | |

Aluminio

2 patillas

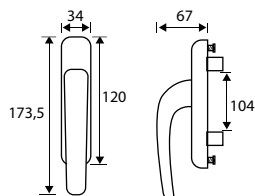

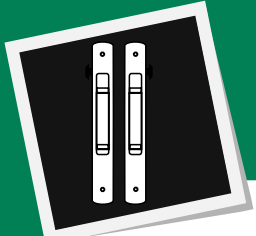

CREMONA 6828

| | Código | 8431488 | Medida | Acabado | | | | €uros |
|----------------|--------------|---------|-----------|---------|---|---|----|-------|
| | 68141 | 681412 | 130x35 mm | BL | - | 1 | 5 | |
| | 68142 | 681429 | 130x35 mm | NE | - | 1 | 5 | |
| <i>Blister</i> | 91940 | 919409 | 130x35 mm | BL | 1 | - | 10 | |
| | 91941 | 919416 | 130x35 mm | NE | 1 | - | 10 | |

1 Patilla

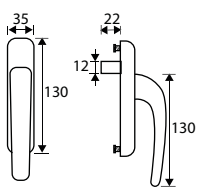

Aluminio
 BLANCO
 NEGRO

CREMONA 6829

| | Código | 8431488 | Medida | Acabado | | | | €uros |
|----------------|--------------|---------|-----------|---------|---|---|----|-------|
| | 68143 | 681436 | 130x35 mm | BL | - | 1 | 5 | |
| | 68144 | 681443 | 130x35 mm | NE | - | 1 | 5 | |
| | 68340 | 683409 | 130x35 mm | PL | - | 1 | 5 | |
| <i>Blister</i> | 91942 | 919423 | 130x35 mm | BL | 1 | - | 10 | |
| | 91943 | 919430 | 130x35 mm | NE | 1 | - | 10 | |
| | 92380 | 923802 | 130x35 mm | PL | 1 | - | 10 | |

2 Patillas

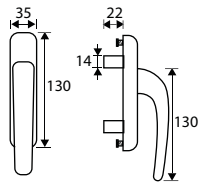

Aluminio
 BLANCO
 NEGRO
 PLATA

CREMONA 6830 (LLAVES IGUALES)

| | Código | 8431488 | Medida | Acabado | | | | €uros |
|----------------|--------------|---------|-----------|---------|---|---|----|-------|
| | 68145 | 681450 | 137x31 mm | BL | - | 1 | 5 | |
| | 68146 | 681467 | 137x31 mm | NE | - | 1 | 5 | |
| <i>Blister</i> | 91944 | 919447 | 137x31 mm | BL | 1 | - | 10 | |
| | 91945 | 919454 | 137x31 mm | NE | 1 | - | 10 | |

2 Patillas con llave

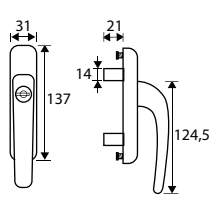

Aluminio
 BLANCO
 NEGRO

CREMONA 6831

| | Código | 8431488 | Medida | Acabado | | | | €uros |
|----------------|--------------|---------|-----------|---------|---|---|----|-------|
| | 68147 | 681474 | 130x35 mm | BL | - | 1 | 5 | |
| | 68148 | 681481 | 130x35 mm | NE | - | 1 | 5 | |
| <i>Blister</i> | 92130 | 921303 | 130x35 mm | BL | 1 | - | 10 | |
| | 91947 | 919478 | 130x35 mm | NE | 1 | - | 10 | |

Patilla "U"

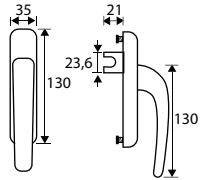

Aluminio
 BLANCO
 NEGRO

CREMONA 6832

| | Código | 8431488 | Medida | Acabado | | | | €uros |
|----------------|--------------|---------|-----------|---------|---|---|----|-------|
| | 68149 | 681498 | 130x35 mm | BL | - | 1 | 5 | |
| | 68150 | 681504 | 130x35 mm | NE | - | 1 | 5 | |
| <i>Blister</i> | 91952 | 919522 | 130x35 mm | BL | 1 | - | 10 | |
| | 91953 | 919539 | 130x35 mm | NE | 1 | - | 10 | |

Aluminio

Patilla con muelle

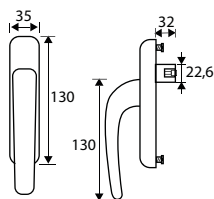

CREMONA SEGURIDAD 6833

| | Código | 8431488 | Medida | Acabado | | | | €uros |
|--|--------------|---------|-----------|---------|---|---|---|-------|
| | 68151 | 681511 | 137x32 mm | BL | - | 1 | 5 | |
| | 68152 | 681528 | 137x32 mm | NE | - | 1 | 5 | |

Aluminio

2 Patillas

No incluye maneta

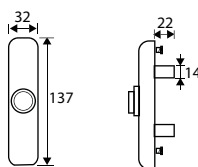
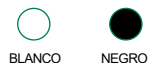

MANETA P/CREMONA 6833

| | Código | 8431488 | Medida | Acabado | | | | €uros |
|--|--------------|---------|-----------|---------|---|---|---|-------|
| | 68153 | 681535 | 123x40 mm | BL | - | 1 | 5 | |
| | 68154 | 681542 | 123x40 mm | NE | - | 1 | 5 | |

Aluminio

No incluye cremona

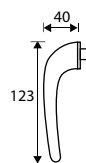

CREMONA + MANETA SEGURIDAD 6833

| | Código | 8431488 | Medida | Acabado | | | | €uros |
|----------------|--------------|---------|-----------|---------|---|---|----|-------|
| <i>Blister</i> | 91948 | 919485 | 137x32 mm | BL | 1 | - | 10 | |
| | 91949 | 919492 | 137x32 mm | NE | 1 | - | 10 | |

Aluminio



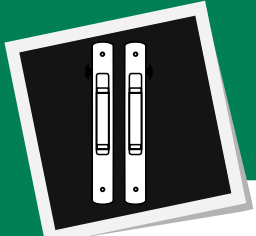

CREMONA SEGURIDAD 6834

| Código | 8431488 | Medida | Acabado | | | | €uros |
|--------------|---------|-----------|---------|---|---|---|-------|
| 68155 | 681559 | 130x35 mm | BL | - | 1 | 5 | |
| 68156 | 681566 | 130x35 mm | NE | - | 1 | 5 | |

2 Patillas
No incluye maneta

Aluminio

BLANCO
 NEGRO

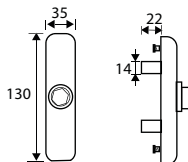

MANETA P/CREMONA 6834

| Código | 8431488 | Medida | Acabado | | | | €uros |
|--------------|---------|-----------|---------|---|---|---|-------|
| 68157 | 681573 | 130x39 mm | BL | - | 1 | 5 | |
| 68158 | 681580 | 130x39 mm | NE | - | 1 | 5 | |

No incluye cremona

Aluminio

BLANCO
 NEGRO

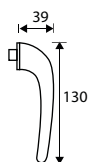

CREMONA + MANETA SEGURIDAD 6834

| Código | 8431488 | Medida | Acabado | | | | €uros |
|-----------------------------|---------|-----------|---------|---|---|----|-------|
| <i>Blister</i> 91950 | 919508 | 130x35 mm | BL | 1 | - | 10 | |
| 91951 | 919515 | 130x35 mm | NE | 1 | - | 10 | |

Aluminio

BLANCO
 NEGRO



CREMONA 6856

| Código | 8431488 | Medida | Acabado | | | | €uros |
|--------------|---------|-----------|---------|---|---|---|-------|
| 68302 | 683027 | 120x32 mm | BL | - | 1 | 5 | |
| 68303 | 683034 | 120x32 mm | NE | - | 1 | 5 | |

2 patillas

Aluminio

BLANCO
 NEGRO

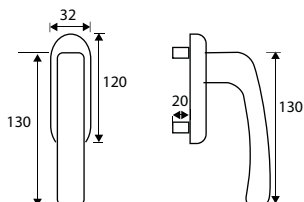

CREMONA AC-20 NEW 6835

| | Código | 8431488 | Medida | Acabado | | | | €uros |
|---------|--------------|---------|-----------|---------|---|---|----|-------|
| | 68161 | 681610 | 135x30 mm | BL | - | 1 | 5 | |
| | 68162 | 681627 | 135x30 mm | NE | - | 1 | 5 | |
| Blister | 91956 | 919560 | 135x30 mm | BL | 1 | - | 10 | |
| | 91957 | 919577 | 135x30 mm | NE | 1 | - | 10 | |

Aluminio

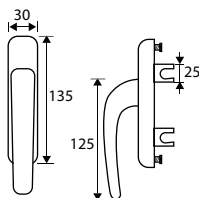

CREMONA AC-20 OLD 6835

| | Código | 8431488 | Medida | Acabado | | | | €uros |
|---------|--------------|---------|-------------|---------|---|---|----|-------|
| | 68159 | 681597 | 139,5x27 mm | BL | - | 1 | 5 | |
| | 68160 | 681603 | 139,5x27 mm | NE | - | 1 | 5 | |
| Blister | 91954 | 919546 | 139,5x27 mm | BL | 1 | - | 10 | |
| | 91955 | 919553 | 139,5x27 mm | NE | 1 | - | 10 | |

Aluminio

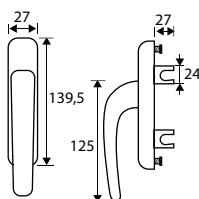

CREMONA FRONTAL 6863

| | Código | 8431488 | Medida | Acabado | | | | €uros |
|--|--------------|--------------|-----------|-----------|---------|---|---|-------|
| | 68327 | 683270 | 180x19 mm | BL / NE | - | 1 | 5 | |
| | Blister | 92326 | 923260 | 180x19 mm | BL / NE | 1 | - | 10 |

Zamak

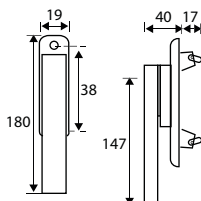

PASADOR SERIE EUROPEA 6837

| | Código | 8431488 | Medida A X B | Acabado | | | | €uros |
|--|--------------|---------|--------------|---------|---|---|---|-------|
| | 68169 | 681696 | 142x20 mm | BL | - | 1 | 5 | |
| | 68170 | 681702 | 142x20 mm | NE | - | 1 | 5 | |
| | 68171 | 681719 | 217x20 mm | BL | - | 1 | 5 | |
| | 68172 | 681726 | 217x20 mm | NE | - | 1 | 5 | |

Aluminio

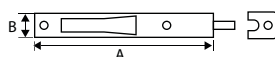

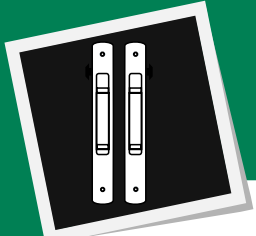

KIT ABATIBLE SERIE 40/20 6852

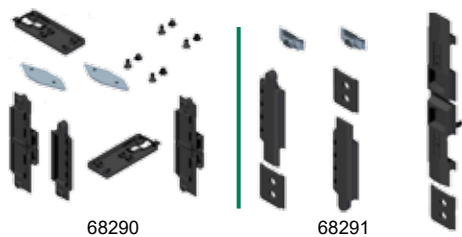

68290

68291

| | Código | 8431488 | Tipo | Acabado | | | | €uros |
|----------------|--------------|---------|---------|---------|---|---|----|-------|
| | 68290 | 682907 | 1 HOJA | NE | - | 1 | 5 | |
| | 68291 | 682914 | 2ª HOJA | NE | - | 1 | 5 | |
| <i>Blister</i> | 92292 | 922928 | 1 HOJA | NE | 1 | - | 10 | |
| | 92293 | 922935 | 2ª HOJA | NE | 1 | - | 10 | |

Nylon



NEGRO

KIT ABATIBLE SERIE EUROPEO 6853

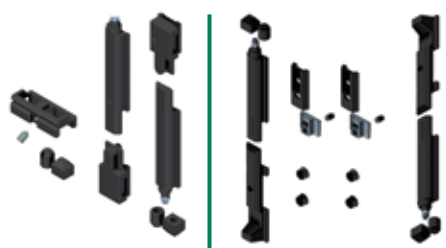

68292

68293

| | Código | 8431488 | Tipo | Acabado | | | | €uros |
|----------------|--------------|---------|---------|---------|---|---|----|-------|
| | 68292 | 682921 | 1 HOJA | NE | - | 1 | 5 | |
| | 68293 | 682938 | 2ª HOJA | NE | - | 1 | 5 | |
| <i>Blister</i> | 92294 | 922942 | 1 HOJA | NE | 1 | - | 10 | |
| | 92295 | 922959 | 2ª HOJA | NE | 1 | - | 10 | |

Nylon



NEGRO

CERRADERO SERIE 40/20 6850



| | Código | 8431488 | Medida | Acabado | | | | €uros |
|----------------|--------------|---------|-------------|---------|---|---|----|-------|
| | 68282 | 682822 | 140x31,5 mm | BL | - | 1 | 5 | |
| | 68283 | 682839 | 140x31,5 mm | NE | - | 1 | 5 | |
| | 68284 | 682846 | 195x31,5 mm | BL | - | 1 | 5 | |
| | 68285 | 682853 | 195x31,5 mm | NE | - | 1 | 5 | |
| <i>Blister</i> | 92284 | 922843 | 140x31,5 mm | BL | 1 | - | 10 | |
| | 92285 | 922850 | 140x31,5 mm | NE | 1 | - | 10 | |
| | 92286 | 922867 | 195x31,5 mm | BL | 1 | - | 10 | |
| | 92287 | 922874 | 195x31,5 mm | NE | 1 | - | 10 | |

Aluminio



BLANCO

NEGRO

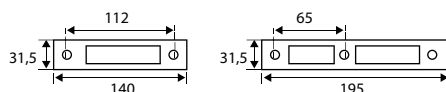

68282-68283

68284-68285

CERRADERO SERIE EUROPEO 6851



| | Código | 8431488 | Medida | Acabado | | | | €uros |
|----------------|--------------|---------|-----------|---------|---|---|----|-------|
| | 68286 | 682860 | 170x22 mm | BL | - | 1 | 5 | |
| | 68287 | 682877 | 170x22 mm | NE | - | 1 | 5 | |
| | 68288 | 682884 | 225x22 mm | BL | - | 1 | 5 | |
| | 68289 | 682891 | 225x22 mm | NE | - | 1 | 5 | |
| <i>Blister</i> | 92288 | 922881 | 170x22 mm | BL | 1 | - | 10 | |
| | 92289 | 922898 | 170x22 mm | NE | 1 | - | 10 | |
| | 92290 | 922904 | 225x22 mm | BL | 1 | - | 10 | |
| | 92291 | 922911 | 225x22 mm | NE | 1 | - | 10 | |

Aluminio



BLANCO

NEGRO

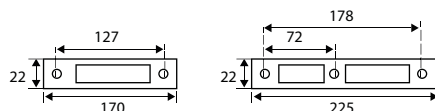

68286-68287

68288-68289

GOLPETE 6810

| | Código | 8431488 | Medida | Acabado | | | | €uros |
|----------------|--------------|---------|----------|---------|---|---|----|-------|
| | 68125 | 681252 | 47x40 mm | BL | - | 1 | 5 | |
| | 68126 | 681269 | 47x40 mm | NE | - | 1 | 5 | |
| | 68127 | 681276 | 47x40 mm | PL | - | 1 | 5 | |
| <i>Blister</i> | 91465 | 914657 | 47x40 mm | BL | 1 | - | 10 | |
| | 91466 | 914664 | 47x40 mm | NE | 1 | - | 10 | |
| | 91467 | 914671 | 47x40 mm | PL | 1 | - | 10 | |

Aluminio

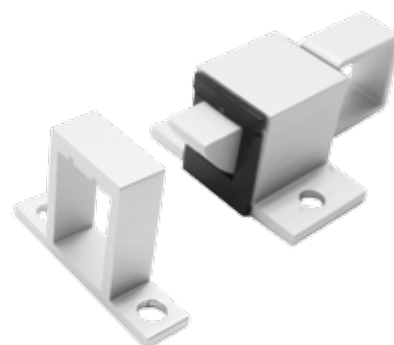
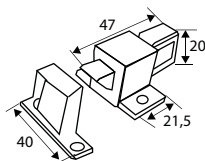

GOLPETE SERIE EUROPEA 6808

| | Código | 8431488 | Medida | Acabado | | | | €uros |
|--|--------------|---------|-------------|---------|---|---|---|-------|
| | 68027 | 680279 | 61x25x40 mm | BL | - | 1 | 5 | |
| | 68028 | 680286 | 61x25x40 mm | NE | - | 1 | 5 | |
| | 68029 | 680293 | 61x25x40 mm | PL | - | 1 | 5 | |

Aluminio

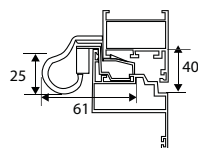

BISAGRA COMPÁS SERIE EUROPEA 6838

| | Código | 8431488 | Medida | Acabado | | | | €uros |
|----------------|--------------|---------|--------|---------|---|---|----|-------|
| | 68173 | 681733 | 150 mm | BL | - | 1 | 5 | |
| | 68174 | 681740 | 150 mm | NE | - | 1 | 5 | |
| <i>Blister</i> | 91968 | 919683 | 150 mm | BL | 1 | - | 10 | |
| | 91969 | 919690 | 150 mm | NE | 1 | - | 10 | |

Aluminio

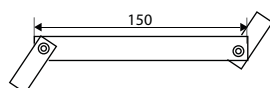

BISAGRA COMPÁS DESMONTABLE 6839

| | Código | 8431488 | Medida | Acabado | | | | €uros |
|----------------|--------------|---------|--------|---------|---|---|----|-------|
| | 68175 | 681757 | 125 mm | BL | - | 1 | 5 | |
| | 68176 | 681764 | 125 mm | NE | - | 1 | 5 | |
| <i>Blister</i> | 91970 | 919706 | 125 mm | BL | 1 | - | 10 | |
| | 91971 | 919713 | 125 mm | NE | 1 | - | 10 | |

Aluminio

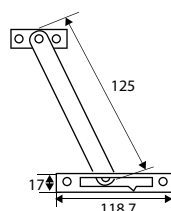
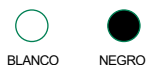

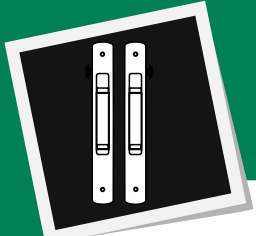

PASADOR PS5 D8

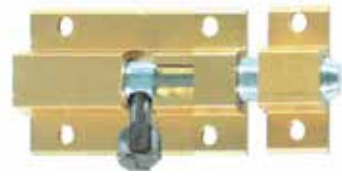

| | Código | 8431488 | Medida A | Acabado | | | | €uros |
|----------------|--------------|---------|----------|---------|----|----|----|-------|
| <i>Caja</i> | 63205 | 632056 | 50 mm | BL | - | 20 | - | |
| | 63207 | 632070 | 75 mm | BL | - | 20 | - | |
| | 63210 | 632100 | 100 mm | BL | - | 20 | - | |
| | 63215 | 632155 | 150 mm | BL | - | 10 | - | |
| | 63220 | 632209 | 200 mm | BL | - | 10 | - | |
| | 63225 | 632254 | 250 mm | BL | - | 10 | - | |
| | 63230 | 632308 | 300 mm | BL | - | 10 | - | |
| | 63240 | 632407 | 400 mm | BL | - | 10 | - | |
| | 63247 | 632476 | 50 mm | NE | - | 20 | - | |
| | 63248 | 632483 | 75 mm | NE | - | 20 | - | |
| | 63249 | 632490 | 100 mm | NE | - | 20 | - | |
| | 63250 | 632506 | 150 mm | NE | - | 10 | - | |
| | 63251 | 632513 | 200 mm | NE | - | 10 | - | |
| | 63252 | 632520 | 250 mm | NE | - | 10 | - | |
| | 63253 | 632537 | 300 mm | NE | - | 10 | - | |
| | 63254 | 632544 | 400 mm | NE | - | 10 | - | |
| | 63305 | 633053 | 50 mm | PL | - | 20 | - | |
| | 63307 | 633077 | 75 mm | PL | - | 20 | - | |
| | 63310 | 633107 | 100 mm | PL | - | 20 | - | |
| | 63315 | 633152 | 150 mm | PL | - | 10 | - | |
| 63320 | 633206 | 200 mm | PL | - | 10 | - | | |
| 63325 | 633251 | 250 mm | PL | - | 10 | - | | |
| 63330 | 633305 | 300 mm | PL | - | 10 | - | | |
| 63340 | 633404 | 400 mm | PL | - | 10 | - | | |
| 63105 | 631059 | 50 mm | OR | - | 20 | - | | |
| 63107 | 631073 | 75 mm | OR | - | 20 | - | | |
| 63110 | 631103 | 100 mm | OR | - | 20 | - | | |
| 63115 | 631158 | 150 mm | OR | - | 10 | - | | |
| 63120 | 631202 | 200 mm | OR | - | 10 | - | | |
| 63125 | 631257 | 250 mm | OR | - | 10 | - | | |
| 63130 | 631301 | 300 mm | OR | - | 10 | - | | |
| 63140 | 631400 | 400 mm | OR | - | 10 | - | | |
| <i>Blister</i> | 90163 | 901633 | 50 mm | BL | 1 | - | 10 | |
| | 91545 | 915456 | 75 mm | BL | 1 | - | 10 | |
| | 90164 | 901640 | 100 mm | BL | 1 | - | 10 | |
| | 91546 | 915463 | 50 mm | NE | 1 | - | 10 | |
| | 91547 | 915470 | 75 mm | NE | 1 | - | 10 | |
| | 91697 | 916972 | 100 mm | NE | 1 | - | 10 | |
| | 90165 | 901657 | 50 mm | PL | 1 | - | 10 | |
| | 91548 | 915487 | 75 mm | PL | 1 | - | 10 | |
| | 90166 | 901664 | 100 mm | PL | 1 | - | 10 | |
| | 90161 | 901619 | 50 mm | OR | 1 | - | 10 | |
| | 91549 | 915494 | 75 mm | OR | 1 | - | 10 | |
| | 90162 | 901626 | 100 mm | OR | 1 | - | 10 | |

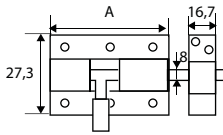

Aluminio

ALUMINIO

PASADOR PS5 D12

| Código | 8431488 | Medida A | Acabado | | | | €uros |
|--------|---------|----------|---------|---|---|----|-------|
| 63241 | 632414 | 100 mm | BL | - | 1 | 10 | |
| 63242 | 632421 | 150 mm | BL | - | 1 | 10 | |
| 63243 | 632438 | 200 mm | BL | - | 1 | 5 | |
| 63244 | 632445 | 250 mm | BL | - | 1 | 5 | |
| 63245 | 632452 | 300 mm | BL | - | 1 | 5 | |
| 63246 | 632469 | 400 mm | BL | - | 1 | 5 | |
| 63255 | 632551 | 100 mm | NE | - | 1 | 10 | |
| 63256 | 632568 | 150 mm | NE | - | 1 | 10 | |
| 63257 | 632575 | 200 mm | NE | - | 1 | 5 | |
| 63258 | 632582 | 250 mm | NE | - | 1 | 5 | |
| 63259 | 632599 | 300 mm | NE | - | 1 | 5 | |
| 63260 | 632605 | 400 mm | NE | - | 1 | 5 | |
| 63341 | 633411 | 100 mm | PL | - | 1 | 10 | |
| 63342 | 633428 | 150 mm | PL | - | 1 | 10 | |
| 63343 | 633435 | 200 mm | PL | - | 1 | 5 | |
| 63344 | 633442 | 250 mm | PL | - | 1 | 5 | |
| 63345 | 633459 | 300 mm | PL | - | 1 | 5 | |
| 63346 | 633466 | 400 mm | PL | - | 1 | 5 | |
| 63141 | 631417 | 100 mm | OR | - | 1 | 10 | |
| 63142 | 631424 | 150 mm | OR | - | 1 | 10 | |
| 63143 | 631431 | 200 mm | OR | - | 1 | 5 | |
| 63144 | 631448 | 250 mm | OR | - | 1 | 5 | |
| 63145 | 631455 | 300 mm | OR | - | 1 | 5 | |
| 63146 | 631462 | 400 mm | OR | - | 1 | 5 | |



Aluminio

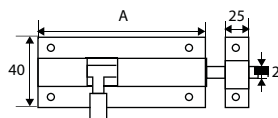

PASADOR RULETA 6825

| Código | 8431488 | Medida | Acabado | | | | €uros |
|--------|---------|------------|---------|---|---|----|-------|
| 68132 | 681320 | 48,5x32 mm | BL | - | 1 | 10 | |
| 68133 | 681337 | 48,5x32 mm | NE | - | 1 | 10 | |
| 68134 | 681344 | 48,5x32 mm | PL | - | 1 | 10 | |
| 91462 | 914626 | 48,5x32 mm | BL | 1 | - | 10 | |
| 91463 | 914633 | 48,5x32 mm | NE | 1 | - | 10 | |
| 91464 | 914640 | 48,5x32 mm | PL | 1 | - | 10 | |

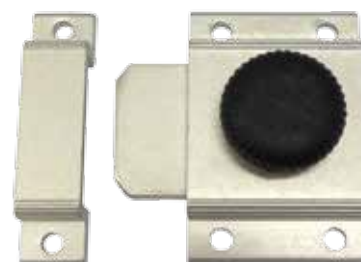

Aluminio

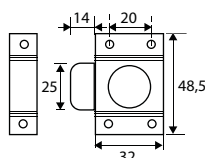

ESCUDO BOCALLAVE 6811

| Código | 8431488 | Medida | Acabado | | | | €uros |
|--------|---------|----------|---------|---|----|-----|-------|
| 68021 | 680217 | 70x30 mm | BL | - | 10 | 100 | |
| 68022 | 680224 | 70x30 mm | NE | - | 10 | 100 | |
| 91460 | 914602 | 70x30 mm | BL | 2 | - | 10 | |
| 91461 | 914619 | 70x30 mm | NE | 2 | - | 10 | |

Nylon

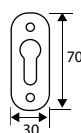

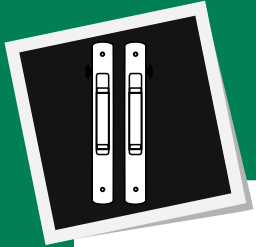

ALUMINIO

MANILLÓN 6860



| | Código | 8431488 | Medida | Acabado | | | | €uros |
|--|--------------|---------|--------|---------|---|---|---|-------|
| | 68318 | 683188 | 350 mm | BL/NE | - | 1 | - | |
| | 68319 | 683195 | 350 mm | NE | - | 1 | - | |
| | 68320 | 683201 | 350 mm | PL/NE | - | 1 | - | |

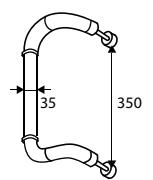

Nylon

JGO MANILLÓN 6860



| | Código | 8431488 | Medida | Acabado | | | | €uros |
|--|--------------|---------|--------|---------|---|---|---|-------|
| | 68321 | 683218 | 350 mm | BL/NE | - | 1 | - | |
| | 68322 | 683225 | 350 mm | NE | - | 1 | - | |
| | 68323 | 683232 | 350 mm | PL/NE | - | 1 | - | |

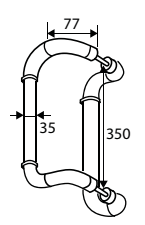

Nylon

MANILLÓN DESPLAZADO 6866



| | Código | 8431488 | Medida | Acabado | | | | €uros |
|--|--------------|---------|--------|---------|---|---|---|-------|
| | 68333 | 683331 | 300 mm | PL | - | 1 | - | |

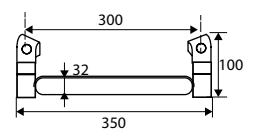

Aluminio

JGO MANILLÓN 6854

| | Código | 8431488 | Medida /Mano | Acabado | | | | €uros |
|--|--------|---------|--------------|---------|---|---|---|-------|
| | 68294 | 682945 | 350 mm | BL | - | 1 | - | |
| | 68295 | 682952 | 350 mm | NE | - | 1 | - | |
| | 68296 | 682969 | 350 mm | EI | - | 1 | - | |

Zamak



Incluye mecanismo individual

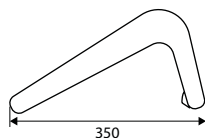

JGO MANILLÓN 6861

| | Código | 8431488 | Medida | Acabado | | | | €uros |
|--|--------|---------|--------|---------|---|---|---|-------|
| | 68324 | 683249 | 350 mm | BL | - | 1 | - | |
| | 68325 | 683256 | 350 mm | NE | - | 1 | - | |

Aluminio

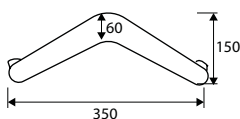

MECANISMO INDIVIDUAL MANILLÓN 6861

| | Código | 8431488 | Medida | Acabado | | | | €uros |
|--|--------|---------|--------------|---------|---|---|---|-------|
| | 68326 | 683263 | 100x30x30 mm | ZN | - | 1 | 6 | |

Acero



ESTUCHE RODAMIENTOS SURTIDOS RD41

| | Código | 8431488 | Medida A - B | Acabado | | | | €uros |
|------|--------|---------|---------------|---------|---|---|---|-------|
| Caja | 68244 | 682440 | 310x240x50 mm | NE | - | 1 | - | |

Contiene 24 referencias - 170 unidades

| Ref. | Descripción | Uds. | Ref. | Descripción | Uds. |
|-------|----------------------------------|------|-------|--------------------------------|------|
| 68227 | RODAMIENTO MOSQUITERA GRANDE | 12 | 68204 | RODAMIENTO METALICO INASA 162 | 4 |
| 68226 | RODAMIENTO MOSQUITERA PEQUEÑO | 12 | 68202 | RODAMIENTO METALICO 158 | 4 |
| 68211 | RODAMIENTO MAMPARA 26mm | 15 | 68201 | RODAMIENTO METALICO 157 | 4 |
| 68210 | RODAMIENTO MAMPARA 20mm | 25 | 68200 | RODAMIENTO METALICO INASA 151 | 6 |
| 68221 | RODAMIENTO MAMPARA 16mm | 25 | 68207 | RODAMIENTO NYLON 172 | 4 |
| 68224 | RODAMIENTO MAMPARA ART 26mm | 4 | 68212 | RODAMIENTO NYLON CO22 | 3 |
| 68223 | RODAMIENTO MAMPARA TUBO 24mm | 6 | 68208 | RODAMIENTO NYLON ENDASA CLL | 5 |
| 68222 | RODAMIENTO MAMPARA TUBO 22mm | 6 | 68233 | RODAMIENTO NYLON 300 ALTA | 3 |
| 68206 | RODAMIENTO NYLON INASA 163 | 3 | 68234 | RODAMIENTO NYLON ELITE VENTANA | 4 |
| 68232 | RODAMIENTO ALUMINIO CO-1B | 5 | 68235 | RODAMIENTO NYLON TRIANA | 4 |
| 68209 | RODAMIENTO METALICO CLL/104 | 5 | 68236 | RODAMIENTO NYLON ALUPRON 21 | 4 |
| 68205 | RODAMIENTO METALICO CLIMALIT 177 | 3 | 68225 | RODAMIENTO NYLON ALUGOM 400 | 4 |



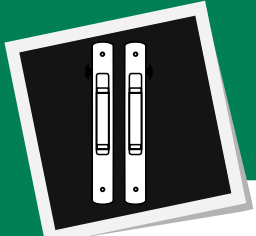

RODAMIENTO 172 RD7

| | Código | 8431488 | Medida | Acabado | | | | €uros |
|---------|--------------|---------|----------|---------|---|----|-----|-------|
| Caja | 68207 | 682075 | 40x30 mm | BL | - | 12 | 300 | |
| Blister | 91334 | 913346 | 40x30 mm | BL | 2 | - | 10 | |

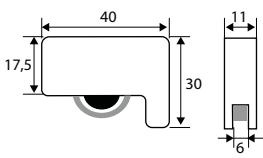

Nylon



BLANCO

RODAMIENTO CO-22 RD8

| | Código | 8431488 | Medida | Acabado | | | | €uros |
|---------|--------------|---------|------------|---------|---|----|-----|-------|
| Caja | 68212 | 682129 | 37x39,5 mm | BL | - | 12 | 300 | |
| Blister | 91339 | 913391 | 37x39,5 mm | BL | 2 | - | 10 | |

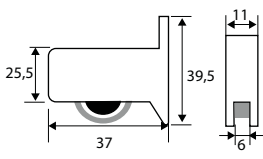

Nylon



BLANCO

RODAMIENTO INASA 163 RD9

| | Código | 8431488 | Medida | Acabado | | | | €uros |
|---------|--------------|---------|------------|---------|---|----|-----|-------|
| Caja | 68206 | 682068 | 40x33,5 mm | BL | - | 12 | 300 | |
| Blister | 91333 | 913339 | 40x33,5 mm | BL | 2 | - | 10 | |

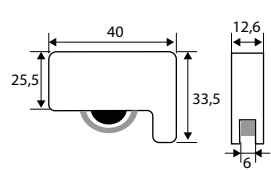

Nylon



BLANCO

RODAMIENTO ENDASA CLL RD10

| | Código | 8431488 | Medida | Acabado | | | | €uros |
|---------|--------------|---------|--------------|---------|---|----|-----|-------|
| Caja | 68208 | 682082 | 33,5x15,5 mm | BL | - | 12 | 300 | |
| Blister | 91335 | 913353 | 33,5x15,5 mm | BL | 2 | - | 10 | |

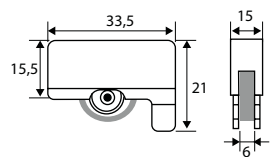

Nylon



BLANCO

RODAMIENTO 300 ALTA RD11

| | Código | 8431488 | Medida | Acabado | | | | €uros |
|---------|--------------|---------|----------|---------|---|----|-----|-------|
| Caja | 68233 | 682334 | 40x30 mm | BL | - | 10 | 120 | |
| Blister | 91898 | 918983 | 40x30 mm | BL | 2 | - | 10 | |

Nylon

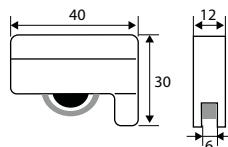

RODAMIENTO ALUGOM 400 RD20

| | Código | 8431488 | Medida | Acabado | | | | €uros |
|---------|--------------|---------|----------|---------|---|----|-----|-------|
| Caja | 68225 | 682259 | 64x25 mm | NE | - | 12 | 240 | |
| Blister | 91800 | 918006 | 64x25 mm | NE | 2 | - | 10 | |

Nylon

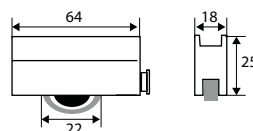

Triple regulación de altura

RODAMIENTO ALUPRON 21 RD21

| | Código | 8431488 | Medida | Acabado | | | | €uros |
|---------|--------------|---------|----------|---------|---|----|-----|-------|
| Caja | 68236 | 682365 | 56x26 mm | NE | - | 12 | 120 | |
| Blister | 91901 | 919010 | 56x26 mm | NE | 2 | - | 10 | |

Nylon

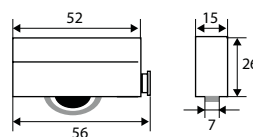

Triple regulación de altura

RODAMIENTO P-60 RD22

| | Código | 8431488 | Medida | Acabado | | | | €uros |
|---------|--------------|---------|----------|---------|---|----|-----|-------|
| Caja | 68237 | 682372 | 57x21 mm | NE | - | 12 | 120 | |
| Blister | 91902 | 919027 | 57x21 mm | NE | 2 | - | 10 | |

Nylon

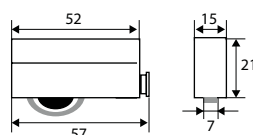

Triple regulación de altura

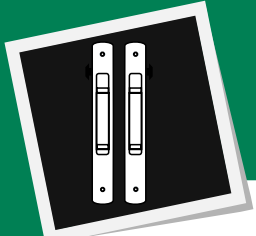

RODAMIENTO ÉLITE VENTANA RD23



| | Código | 843 1488 | Medida | Acabado | | | | €uros |
|---------|--------------|----------|------------|---------|---|----|-----|-------|
| Caja | 68234 | 682341 | 52,5x24 mm | NE | - | 12 | 120 | |
| Blister | 91899 | 918990 | 52,5x24 mm | NE | 2 | - | 10 | |

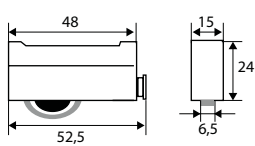

Nylon



NEGRO



Doble regulación de altura

RODAMIENTO TRIANA RD24



| | Código | 843 1488 | Medida | Acabado | | | | €uros |
|---------|--------------|----------|------------|---------|---|----|-----|-------|
| Caja | 68235 | 682358 | 54,5x23 mm | NE | - | 12 | 120 | |
| Blister | 91900 | 919003 | 54,5x23 mm | NE | 2 | - | 10 | |

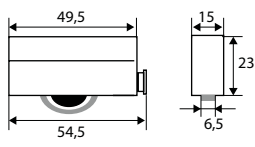

Nylon



NEGRO



Triple regulación de altura

RODAMIENTO INASA 151 RD12



| | Código | 843 1488 | Medida | Acabado | | | | €uros |
|---------|--------------|----------|------------|---------|---|----|-----|-------|
| Caja | 68200 | 682006 | 36x12,2 mm | ZN | - | 12 | 300 | |
| Blister | 91327 | 913278 | 36x12,2 mm | ZN | 2 | - | 10 | |

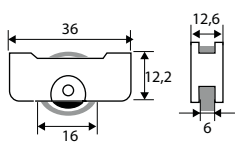

Acero



ZINCADO

RODAMIENTO 157 RD13



| | Código | 843 1488 | Medida | Acabado | | | | €uros |
|---------|--------------|----------|----------|---------|---|----|-----|-------|
| Caja | 68201 | 682013 | 45x20 mm | BC | - | 12 | 300 | |
| Blister | 91328 | 913285 | 45x20 mm | BC | 2 | - | 10 | |

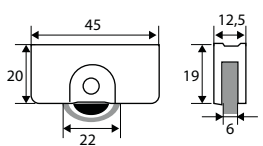



Acero



BICOMATADO

RODAMIENTO 158 RD14

| | Código | 8431488 | Medida | Acabado |  |  |  | €uros |
|---------|--------------|---------|----------|---------|---|---|---|-------|
| Caja | 68202 | 682020 | 45x20 mm | BC | - | 12 | 300 | |
| Blister | 91329 | 913292 | 45x20 mm | BC | 2 | - | 10 | |



Acero

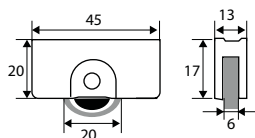

BICROMATADO



RODAMIENTO 158/S RD15

| | Código | 8431488 | Medida | Acabado |  |  |  | €uros |
|---------|--------------|---------|----------|---------|---|---|---|-------|
| Caja | 68203 | 682037 | 45x20 mm | BC | - | 12 | 300 | |
| Blister | 91330 | 913308 | 45x20 mm | BC | 2 | - | 10 | |



Acero

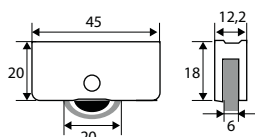

BICROMATADO



RODAMIENTO INASA 162 RD16

| | Código | 8431488 | Medida | Acabado |  |  |  | €uros |
|---------|--------------|---------|------------|---------|---|---|---|-------|
| Caja | 68204 | 682044 | 45x25,5 mm | ZN | - | 12 | 300 | |
| Blister | 91331 | 913315 | 45x25,5 mm | ZN | 2 | - | 10 | |



Acero

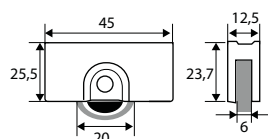

ZINCADO



RODAMIENTO CLIMALIT 177 RD17

| | Código | 8431488 | Medida | Acabado |  |  |  | €uros |
|---------|--------------|---------|----------|---------|---|---|---|-------|
| Caja | 68205 | 682051 | 40x21 mm | ZN | - | 12 | 300 | |
| Blister | 91332 | 913322 | 40x21 mm | ZN | 2 | - | 10 | |

Acero



ZINCADO

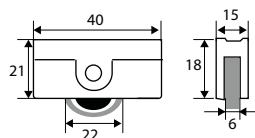

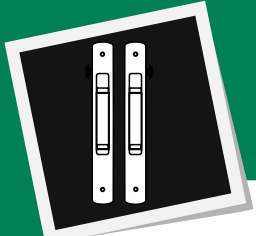

RODAMIENTO CLL/ 104 RD18



| | Código | 8431488 | Medida | Acabado | | | | €uros |
|---------|--------------|---------|------------|---------|---|----|-----|-------|
| Caja | 68209 | 682099 | 45,2x15 mm | BC | - | 12 | 300 | |
| Blister | 91336 | 913360 | 45,2x15 mm | BC | 2 | - | 10 | |

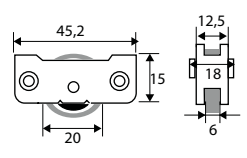

Acero

 BICROMATADO

RODAMIENTO CO-22 RD19



| | Código | 8431488 | Medida | Acabado | | | | €uros |
|---------|--------------|---------|----------|---------|---|----|-----|-------|
| Caja | 68267 | 682679 | 40x16 mm | BC | - | 12 | 300 | |
| Blister | 92230 | 922300 | 40x16 mm | BC | 2 | - | 10 | |

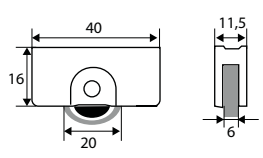

Acero

 BICROMATADO

RODAMIENTO REGULABLE INASA 2000 RD34



| | Código | 8431488 | Medida | Acabado | | | | €uros |
|---------|--------------|---------|----------|---------|---|----|-----|-------|
| Caja | 68230 | 682303 | 55x20 mm | ZN | - | 12 | 300 | |
| Blister | 91895 | 918952 | 55x20 mm | ZN | 2 | - | 10 | |

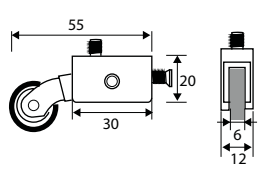

Acero

 ZINCADO

RODAMIENTO REGULABLE INASA 300 RD35



| | Código | 8431488 | Medida | Acabado | | | | €uros |
|---------|--------------|---------|----------|---------|---|----|-----|-------|
| Caja | 68231 | 682310 | 57x25 mm | ZN | - | 12 | 120 | |
| Blister | 91896 | 918969 | 57x25 mm | ZN | 2 | - | 10 | |

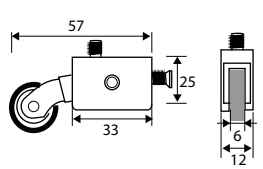

Acero

 ZINCADO

RODAMIENTO CO-1B RD31

| | Código | 8431488 | Medida | Acabado | | | €uros |
|---------|--------------|---------|----------|---------|---|--------|-------|
| Caja | 68232 | 682327 | 40x12 mm | AL | - | 12 300 | |
| Blister | 91897 | 918976 | 40x12 mm | AL | 2 | - 10 | |

Aluminio

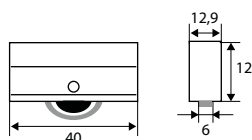

RODAMIENTO CO-36 RD32

| | Código | 8431488 | Medida | Acabado | | | €uros |
|---------|--------------|---------|----------|---------|---|--------|-------|
| Caja | 68265 | 682655 | 39x16 mm | ZN | - | 12 300 | |
| Blister | 92228 | 922287 | 39x16 mm | ZN | 2 | - 10 | |

Zamak

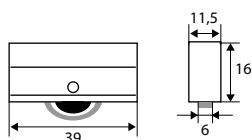

RODAMIENTO CO-22 RD33

| | Código | 8431488 | Medida | Acabado | | | €uros |
|---------|--------------|---------|----------|---------|---|--------|-------|
| Caja | 68266 | 682662 | 39x14 mm | AL | - | 12 300 | |
| Blister | 92229 | 922294 | 39x14 mm | AL | 2 | - 10 | |

Aluminio

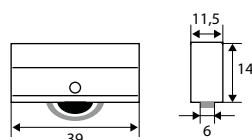

RODAMIENTO VITRINA RD29

| | Código | 8431488 | Medida | Acabado | | | €uros |
|---------|--------------|---------|----------|---------|---|--------|-------|
| Caja | 68228 | 682280 | 40x11 mm | ZN | - | 12 300 | |
| Blister | 91893 | 918938 | 40x11 mm | ZN | 2 | - 10 | |

Acero

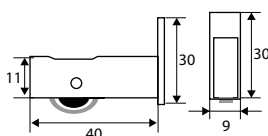

RODAMIENTO VITRINA RD30

| | Código | 8431488 | Medida | Acabado | | | €uros |
|---------|--------------|---------|------------|---------|---|--------|-------|
| Caja | 68229 | 682297 | 56,5x14 mm | NE | - | 12 300 | |
| Blister | 91894 | 918945 | 56,5x14 mm | NE | 2 | - 10 | |

Nylon

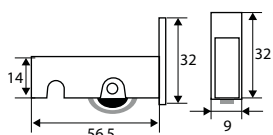

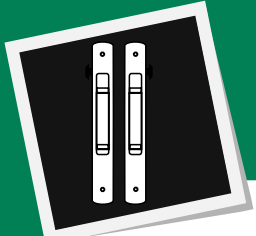

RODAMIENTO REGULABLE ALUGOM 400 RD36

| | Código | 8431488 | Medidas | Acabado | | | | €uros |
|---------|--------------|---------|----------|---------|---|----|-----|-------|
| Caja | 68260 | 682600 | 75x18 mm | ZN | - | 12 | 120 | |
| Blister | 92222 | 922225 | 75x18 mm | ZN | 2 | - | 10 | |

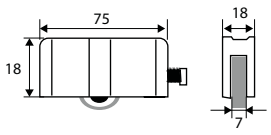

Acero

ZINCADO

RODAMIENTO REGULABLE ALUPRON 21 RD37

| | Código | 8431488 | Medida | Acabado | | | | €uros |
|---------|--------------|---------|----------|---------|---|----|-----|-------|
| Caja | 68261 | 682617 | 70x16 mm | ZN | - | 12 | 120 | |
| Blister | 92223 | 922232 | 70x16 mm | ZN | 2 | - | 10 | |

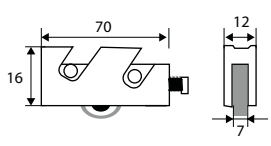

Acero

ZINCADO

RODAMIENTO REGULABLE SILVER 60 RD38

| | Código | 8431488 | Medida | Acabado | | | | €uros |
|---------|--------------|---------|----------|---------|---|----|-----|-------|
| Caja | 68262 | 682624 | 79x21 mm | ZN | - | 12 | 120 | |
| Blister | 92224 | 922249 | 79x21 mm | ZN | 2 | - | 10 | |

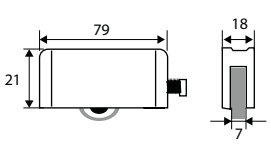

Acero

ZINCADO

RODAMIENTO REGULABLE P60/P65 RD39

| | Código | 8431488 | Medida | Acabado | | | | €uros |
|---------|--------------|---------|----------|---------|---|----|-----|-------|
| Caja | 68263 | 682631 | 75x15 mm | ZN | - | 12 | 120 | |
| Blister | 92225 | 922256 | 75x15 mm | ZN | 2 | - | 10 | |

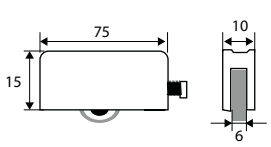

Acero

ZINCADO

RODAMIENTO REGULABLE CORTIZO 5200 RD40

| | Código | 8431488 | Medida | Acabado | | | | €uros |
|---------|--------------|---------|----------|---------|---|----|-----|-------|
| Caja | 68264 | 682648 | 72x28 mm | ZN | - | 12 | 120 | |
| Blister | 92226 | 922263 | 72x28 mm | ZN | 2 | - | 10 | |

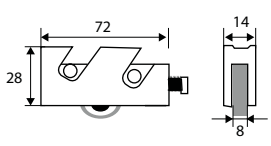

Acero

ZINCADO

RODAMIENTO MAMPARA RD1

| | Código | 8431488 | Medida A | Acabado | | | | €uros |
|---------|--------|---------|----------|---------|---|----|-----|-------|
| Caja | 68221 | 682211 | 16 mm | NE | - | 25 | 625 | |
| | 68210 | 682105 | 20 mm | NE | - | 25 | 625 | |
| | 68211 | 682112 | 26 mm | NE | - | 25 | 625 | |
| Blister | 91796 | 917962 | 16 mm | NE | 2 | - | 10 | |
| | 91337 | 913377 | 20 mm | NE | 2 | - | 10 | |
| | 91338 | 913384 | 26 mm | NE | 2 | - | 10 | |

Nylon



Incluye tornillo

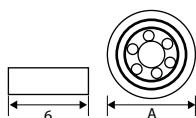

RODAMIENTO MAMPARA C/SEPARADOR RD1

| | Código | 8431488 | Medida A - Separador B | Acabado | | | | €uros |
|---------|--------|---------|------------------------|---------|---|----|-----|-------|
| Caja | 68251 | 682518 | 20 mm - 6 mm | NE | - | 12 | 300 | |
| | 68252 | 682525 | 20 mm - 12 mm | NE | - | 12 | 300 | |
| | 68253 | 682532 | 20 mm - 17 mm | NE | - | 12 | 300 | |
| | 68254 | 682549 | 26 mm - 6 mm | NE | - | 12 | 300 | |
| | 68255 | 682556 | 26 mm - 12 mm | NE | - | 12 | 300 | |
| | 68256 | 682563 | 26 mm - 17 mm | NE | - | 12 | 300 | |
| Blister | 92213 | 922133 | 20 mm - 6 mm | NE | 2 | - | 10 | |
| | 92214 | 922140 | 20 mm - 12 mm | NE | 2 | - | 10 | |
| | 92215 | 922157 | 20 mm - 17 mm | NE | 2 | - | 10 | |
| | 92216 | 922164 | 26 mm - 6 mm | NE | 2 | - | 10 | |
| | 92217 | 922171 | 26 mm - 12 mm | NE | 2 | - | 10 | |
| | 92218 | 922188 | 26 mm - 17 mm | NE | 2 | - | 10 | |

Nylon

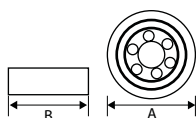

SEPARADOR P/RODAMIENTO MAMPARA RD1

| | Código | 8431488 | Medida A | Acabado | | | | €uros |
|---------|--------|---------|----------|---------|---|----|-----|-------|
| Caja | 68257 | 682570 | 6 mm | LT | - | 25 | 625 | |
| | 68258 | 682587 | 12 mm | LT | - | 25 | 625 | |
| | 68259 | 682594 | 17 mm | LT | - | 25 | 625 | |
| Blister | 92219 | 922195 | 6 mm | LT | 2 | - | 10 | |
| | 92220 | 922201 | 12 mm | LT | 2 | - | 10 | |
| | 92221 | 922218 | 17 mm | LT | 2 | - | 10 | |

Latón



TORNILLO RODAMIENTO MAMPARA RD1

| | Código | 8431488 | Medida AxB | Acabado | | | | €uros |
|------|--------|---------|------------|---------|---|----|------|-------|
| Caja | 68249 | 682495 | M3x6 mm | INOX | - | 25 | 2500 | |
| | 68213 | 682136 | M4x8 mm | INOX | - | 25 | 2500 | |
| | 68250 | 682501 | M5x8 mm | INOX | - | 12 | 2400 | |

Acero Inoxidable

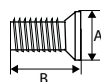

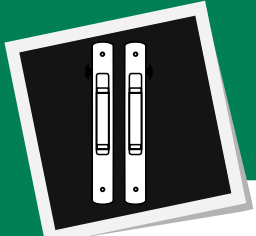

RODAMIENTO MAMPARA RD25

| | Código | 843 1488 | Medida | Acabado | | | | €uros |
|---------|--------------|----------|----------|---------|---|----|-----|-------|
| Caja | 68238 | 682389 | 22x19 mm | BL | - | 12 | 300 | |
| Blíster | 91903 | 919034 | 22x19 mm | BL | 2 | - | 10 | |



Incluye tornillo M5

Nylon

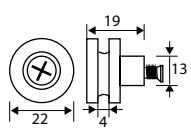

BLANCO

RODAMIENTO MAMPARA RD26

| | Código | 843 1488 | Medida | Acabado | | | | €uros |
|---------|--------------|----------|----------|---------|---|----|-----|-------|
| Caja | 68239 | 682396 | 25x19 mm | BL | - | 12 | 300 | |
| Blíster | 91904 | 919041 | 25x19 mm | BL | 2 | - | 10 | |



Incluye tornillo M5

Nylon

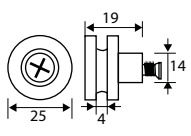

BLANCO

RODAMIENTO MAMPARA RD27

| | Código | 843 1488 | Medida | Acabado | | | | €uros |
|---------|--------------|----------|----------|---------|---|----|-----|-------|
| Caja | 68240 | 682402 | 25x16 mm | BL | - | 12 | 300 | |
| Blíster | 91905 | 919058 | 25x16 mm | BL | 2 | - | 10 | |



Incluye tornillo M5

Nylon

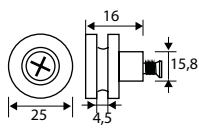

BLANCO

RODAMIENTO MAMPARA RD28

| | Código | 843 1488 | Medida | Acabado | | | | €uros |
|---------|--------------|----------|----------|---------|---|----|-----|-------|
| Caja | 68241 | 682419 | 24x16 mm | BL | - | 12 | 300 | |
| Blíster | 91906 | 919065 | 24x16 mm | BL | 2 | - | 10 | |



Incluye tornillo M5

Nylon

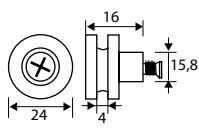

BLANCO

RODAMIENTO MAMPARA RD2

| | Código | 8431488 | Medida | Acabado | | | | €uros |
|---------|--------------|---------|--------|---------|---|----|-----|-------|
| Caja | 68222 | 682228 | 22 mm | BL | - | 12 | 300 | |
| | 68223 | 682235 | 24 mm | BL | - | 12 | 300 | |
| Blister | 91797 | 917979 | 22 mm | BL | 2 | - | 10 | |
| | 91798 | 917986 | 24 mm | BL | 2 | - | 10 | |

Nylon

BLANCO

Incluye tornillo

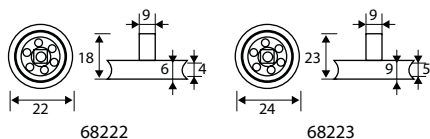

RODAMIENTO MAMPARA ARTICULADO RD3

| | Código | 8431488 | Medida | Acabado | | | | €uros |
|---------|--------------|---------|--------|---------|---|----|-----|-------|
| Caja | 68224 | 682242 | 26 mm | BL | - | 12 | 300 | |
| Blister | 91799 | 917993 | 26 mm | BL | 2 | - | 10 | |

Nylon

BLANCO

Incluye tornillo

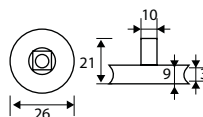

RODAMIENTO MAMPARA ARTICULADO RD6

| | Código | 8431488 | Medida | Acabado | | | | €uros |
|---------|--------------|---------|--------|---------|---|----|-----|-------|
| Caja | 68269 | 682693 | 21 mm | BL | - | 12 | 120 | |
| Blister | 92235 | 922355 | 21 mm | BL | 2 | - | 10 | |

Nylon

BLANCO

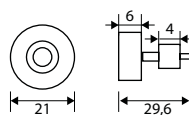

JGO RODAMIENTO MAMPARA RD4

| | Código | 8431488 | Medidas | Acabado | | | | €uros |
|---------|--------------|---------|---------|---------|---|---|----|-------|
| Caja | 68268 | 682686 | 23 mm | GR/BL | - | 2 | 50 | |
| Blister | 92231 | 922317 | 23 mm | GR/BL | 1 | - | 10 | |

Nylon

GRIS/
BLANCO

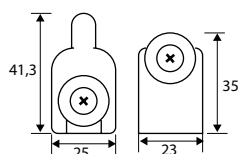

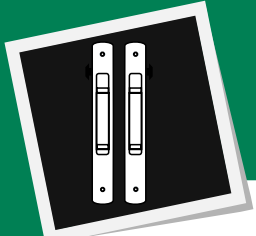

ALUMINIO

RODAMIENTO MOSQUITERA RD5



| | Código | 8431488 | Medida A | Acabado | | | | €uros |
|---------|--------------|---------|----------|---------|---|----|-----|-------|
| Caja | 68226 | 682266 | 21 mm | NE | - | 12 | 300 | |
| | 68227 | 682273 | 23 mm | NE | - | 12 | 300 | |
| Blister | 91891 | 918914 | 21 mm | NE | 2 | - | 10 | |
| | 91892 | 918921 | 23 mm | NE | 2 | - | 10 | |

Poliamida



NEGRO

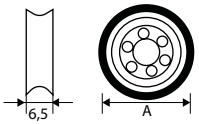

KIT MOSQUITERA CORREDERA MQ2



| | Código | 8431488 | Medida | Acabado | | | | €uros |
|---------|--------------|---------|---------|---------|---|---|----|-------|
| | 68247 | 682471 | pequeño | BL | - | 5 | 50 | |
| | 68248 | 682488 | pequeño | NE | - | 5 | 50 | |
| | 68245 | 682457 | grande | BL | - | 5 | 50 | |
| | 68246 | 682464 | grande | NE | - | 5 | 50 | |
| Blister | 92186 | 921860 | pequeño | BL | 1 | - | 10 | |
| | 92187 | 921877 | pequeño | NE | 1 | - | 10 | |
| | 92184 | 921846 | grande | BL | 1 | - | 10 | |
| | 92185 | 921853 | grande | NE | 1 | - | 10 | |

Poliamida



BLANCO NEGRO

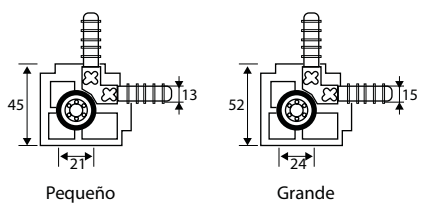

Pequeño

Grande



JGO ENGANCHE MOSQUITERA MQ1



| | Código | 8431488 | Medida | Acabado | | | | €uros |
|---------|--------------|---------|------------|---------|---|----|-----|-------|
| | 68242 | 682426 | 52,5x30 mm | BL | - | 10 | 100 | |
| | 68243 | 682433 | 52,5x30 mm | NE | - | 10 | 100 | |
| Blister | 92137 | 921372 | 52,5x30 mm | BL | 1 | - | 10 | |
| | 92138 | 921389 | 52,5x30 mm | NE | 1 | - | 10 | |

Nylon



BLANCO NEGRO

