

EMBELLECEDOR LISO SC1

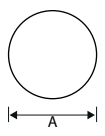

	Código	8431488	Medida A	Acabado				€uros
Caja	45121	451213	12 mm	LT	-	100	1000	
	45141	451411	14 mm	LT	-	100	1000	
	45161	451619	16 mm	LT	-	100	1000	
	45181	451817	18 mm	LT	-	100	1000	
	45122	451220	12 mm	NI	-	100	1000	
	45142	451428	14 mm	NI	-	100	1000	
	45162	451626	16 mm	NI	-	100	1000	
	45182	451824	18 mm	NI	-	100	1000	
Blister	90380	903804	12 mm	LT	4	-	10	
	90381	903811	14 mm	LT	4	-	10	
	90382	903828	16 mm	LT	4	-	10	
	90383	903835	18 mm	LT	4	-	10	
	90384	903842	12 mm	NI	4	-	10	
	90385	903859	14 mm	NI	4	-	10	
	90386	903866	16 mm	NI	4	-	10	
	90387	903873	18 mm	NI	4	-	10	



Latón
 LATÓN
 NIQUEL

EMBELLECEDOR FACETADO SC2



	Código	8431488	Medida A	Acabado				€uros
Caja	46121	461212	12 mm	LT	-	100	1000	
	46141	461410	14 mm	LT	-	100	1000	
	46161	461618	16 mm	LT	-	100	1000	
	46181	461816	18 mm	LT	-	100	1000	
	46122	461229	12 mm	NI	-	100	1000	
	46142	461427	14 mm	NI	-	100	1000	
	46162	461625	16 mm	NI	-	100	1000	
	46182	461823	18 mm	NI	-	100	1000	
Blister	90388	903880	12 mm	LT	4	-	10	
	90389	903897	14 mm	LT	4	-	10	
	90390	903903	16 mm	LT	4	-	10	
	90391	903910	18 mm	LT	4	-	10	
	90392	903927	12 mm	NI	4	-	10	
	90393	903934	14 mm	NI	4	-	10	
	90394	903941	16 mm	NI	4	-	10	
	90395	903958	18 mm	NI	4	-	10	

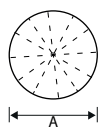

Latón
 LATÓN
 NIQUEL

SUJETALUNAS SC3

	Código	8431488	Medida	Acabado				€uros
Caja	47011	470115	2-6 mm	latón liso	-	100	1000	
	47111	471112	5-8 mm	latón liso	-	100	500	
	47012	470122	2-6 mm	níquel liso	-	100	1000	
	47112	471129	5-8 mm	níquel liso	-	100	500	
	48011	480114	2-6 mm	latón facetado	-	100	1000	
	48111	481111	5-8 mm	latón facetado	-	100	500	
	48012	480121	2-6 mm	níquel facetado	-	100	1000	
	48112	481128	5-8 mm	níquel facetado	-	100	500	
Blister	90396	903965	2-6 mm	latón liso	4	-	10	
	90397	903972	5-8 mm	latón liso	4	-	10	
	90398	903989	2-6 mm	níquel liso	4	-	10	
	90399	903996	5-8 mm	níquel liso	4	-	10	
	90400	904009	2-6 mm	latón facetado	4	-	10	
	90401	904016	5-8 mm	latón facetado	4	-	10	
	90402	904023	2-6 mm	níquel facetado	4	-	10	
	90403	904030	5-8 mm	níquel facetado	4	-	10	

Latón

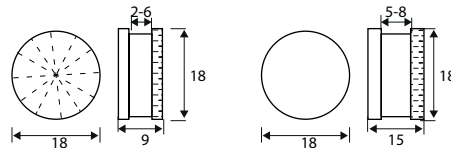

SEPARADOR CRISTAL SC8

	Código	8431488	Medida AxBxC	Acabado				€uros
Caja	32516	325163	12x25x20 mm	INOX	-	4	24	
	32517	325170	15x50x45 mm	INOX	-	4	24	
	32518	325187	18x75x65 mm	INOX	-	4	24	
	32519	325194	20x100x95 mm	INOX	-	4	24	

Acero Inoxidable

Válido para cristal máx. 10 mm

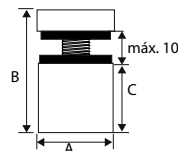

JGO SOPORTE ESPEJOS SC7

	Código	8431488	Medida	Acabado				€uros
Blister	30513	305134	45x25 mm	ZN	1	-	25	

Acero

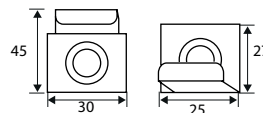

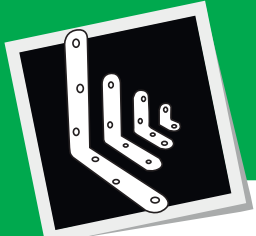

SOPORTE CILÍNDRICO SC4

	Código	8431488	Medida	Acabado				€uros
Caja	32701	327013	5-6 mm	OR	-	50	250	
	32702	327020	5-6 mm	CB	-	50	250	
	32703	327037	5-6 mm	CM	-	50	250	
	32704	327044	5-6 mm	BL	-	50	250	
	32712	327129	8-10 mm	CB	-	50	250	
	32713	327136	8-10 mm	CM	-	50	250	
Blister	90404	904047	5-6 mm	OR	2	-	10	
	90405	904054	5-6 mm	CB	2	-	10	
	90406	904061	5-6 mm	CM	2	-	10	
	90407	904078	5-6 mm	BL	2	-	10	
	90410	904108	8-10 mm	CB	2	-	10	
	90411	904115	8-10 mm	CM	2	-	10	

Incluye tornillo y tapón de plástico

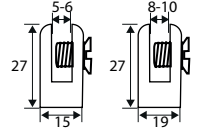

Zamak

ORO
 CROMO BRILLO
 CROMO MATE
 BLANCO

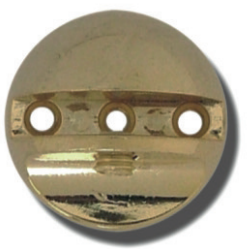

SOPORTE ESFÉRICO SC5

	Código	8431488	Medida A	Acabado				€uros
Caja	32601	326016	5-6 mm	OR	-	25	125	
	32602	326023	5-6 mm	CB	-	25	125	
	32603	326030	5-6 mm	CM	-	25	125	
	32604	326047	5-6 mm	BL	-	25	125	
	32605	326054	5-6 mm	NE	-	25	125	

Incluye tornillo y tapón de plástico

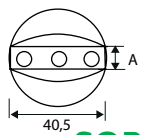

Zamak

ORO
 CROMO BRILLO
 CROMO MATE
 BLANCO
 NEGRO



SOPORTE MEDIA LUNA SC6

	Código	8431488	Medida A	Acabado				€uros
Caja	32501	325019	5-6 mm	OR	-	50	150	
	32502	325026	5-6 mm	CB	-	50	150	
	32503	325033	5-6 mm	CM	-	50	150	
	32504	325040	5-6 mm	BL	-	50	150	
	32511	325118	8-10 mm	OR	-	50	150	
	32512	325125	8-10 mm	CB	-	50	150	
	32513	325132	8-10 mm	CM	-	50	150	
	32514	325149	8-10 mm	BL	-	50	150	
Blister	90419	904191	5-6 mm	OR	2	-	10	
	90420	904207	5-6 mm	CB	2	-	10	
	90421	904214	5-6 mm	CM	2	-	10	
	90422	904221	5-6 mm	BL	2	-	10	
	90428	904283	8-10 mm	OR	2	-	10	
	90429	904290	8-10 mm	CB	2	-	10	
	90430	904306	8-10 mm	CM	2	-	10	
	90431	904313	8-10 mm	BL	2	-	10	

Incluye tornillo y tapón de plástico

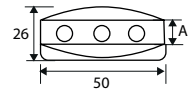

Zamak

ORO
 CROMO BRILLO
 CROMO MATE
 BLANCO

SOPORTE CRISTAL PIVOTE SC9

	Código	8431488	Medida	Acabado			€uros
Caja	31604	316048	5 mm	NI	-	100 500	

Zamak

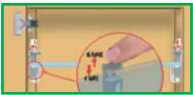

Apertura 4-8 mm

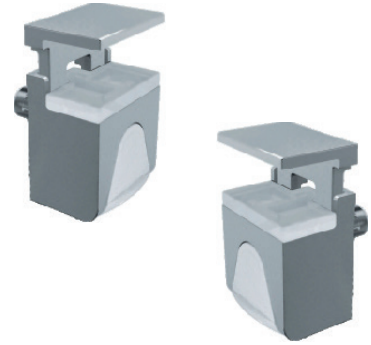
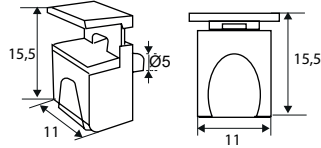

SOPORTE PELÍCANO SP5

	Código	8431488	Medida	Acabado			€uros
Caja	31209	312095	30x46 mm	CM	-	2 38	

Zamak

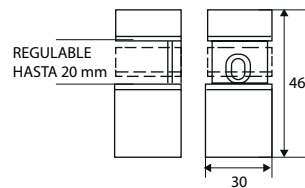

SOPORTE PELÍCANO SP6

	Código	8431488	Medida	Acabado			€uros
Caja	31210	312101	77x112 mm	CM	-	2 38	

Zamak

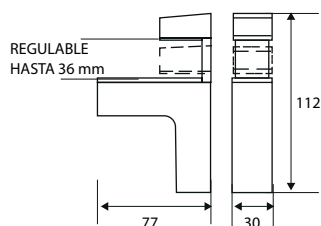

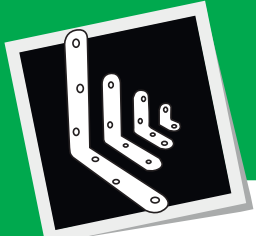

SOPORTE PELÍCANO SP8

	Código	8431488	Medida	Acabado				€uros
Caja	31241	312415	42x53 mm	BL	-	2	38	
	31243	312439	42x53 mm	OR	-	2	38	
	31245	312453	42x53 mm	CM	-	2	38	
Blíster	91820	918204	42x53 mm	BL	2	-	10	
	91821	918211	42x53 mm	OR	2	-	10	
	91822	918228	42x53 mm	CM	2	-	10	

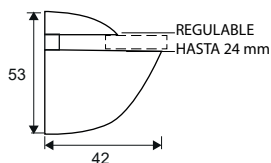

Zamak

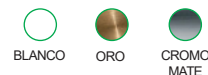

SOPORTE PELÍCANO SP4

	Código	8431488	Medida	Acabado				€uros
Caja	31201	312019	75x65 mm	BL	-	2	38	
	31202	312026	75x65 mm	NE	-	2	38	
	31203	312033	75x65 mm	OR	-	2	38	
	31204	312040	75x65 mm	CB	-	2	38	
	31205	312057	75x65 mm	CM	-	2	38	
Blíster	90622	906225	75x65 mm	BL	2	-	10	
	90623	906232	75x65 mm	NE	2	-	10	
	90624	906249	75x65 mm	OR	2	-	10	
	90625	906256	75x65 mm	CB	2	-	10	
	90626	906263	75x65 mm	CM	2	-	10	

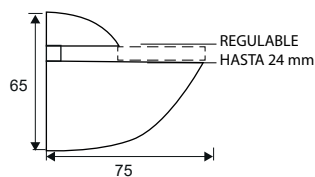

Zamak

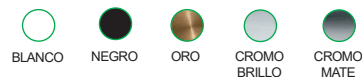

SOPORTE PELÍCANO SP7

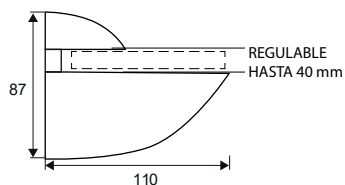

	Código	8431488	Medida AxB	Acabado				€uros
Caja	31221	312217	110x87 mm	BL	-	2	38	
	31222	312224	110x87 mm	NE	-	2	38	
	31223	312231	110x87 mm	OR	-	2	38	
	31224	312248	110x87 mm	CM	-	2	38	
	31225	312255	110x87 mm	NS	-	2	38	
	31226	312262	110x87 mm	CU	-	2	38	
	31227	312279	110x87 mm	LE	-	2	38	



Zamak



SOPORTE PELÍCANO SP1

	Código	8431488	Medida	Acabado				€uros
Caja	31206	312064	28x39 mm	CM	-	2	50	

Zamak



CROMO
MATE

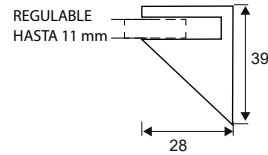

SOPORTE PELÍCANO SP2

	Código	8431488	Medida	Acabado				€uros
Caja	31207	312071	111x70 mm	CM	-	2	38	

Zamak



CROMO
MATE

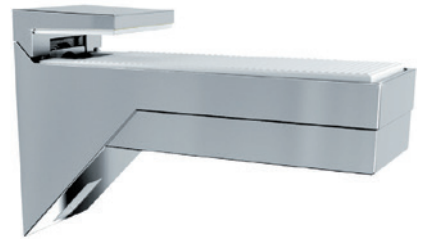
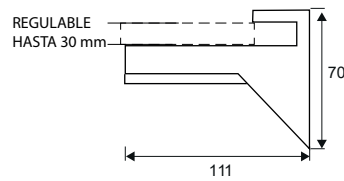

SOPORTE PELÍCANO SP3

	Código	8431488	Medida	Acabado				€uros
Caja	31208	312088	111x70 mm	CM	-	2	38	

Zamak



CROMO
MATE

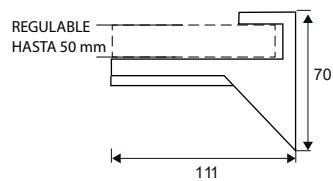

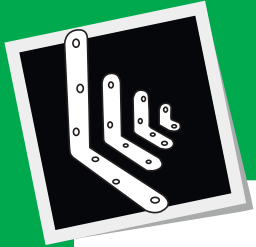

SOPORTE BALDA OCULTO SBO3



	Código	8431488	Medida A	Acabado				€uros
Caja	31121	311210	150 mm	BC	-	20	200	
	31122	311227	190 mm	BC	-	20	100	

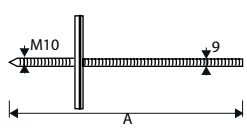

Acero
 BICROMATADO

SOPORTE BALDA OCULTO



	Código	8431488	Medida AxB	Acabado				€uros
Caja	31123	311234	8x100 mm	ZN	-	20	100	
	31124	311241	8x140 mm	ZN	-	20	100	
	31125	311258	10x100 mm	ZN	-	20	100	
	31126	311265	10x140 mm	ZN	-	20	100	
	31127	311272	10x170 mm	ZN	-	20	100	

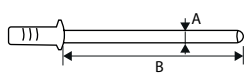

Acero
 ZINCADO

SOPORTE BALDA OCULTO SBO1



	Código	8431488	Medida	Acabado				€uros
Caja	31128	311289	150 mm	ZN	-	10	50	

Peso máx.: 15 Kgs

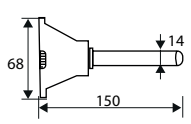

Regulación:
 Vertical - 5 mm
 Horizontal - 5 mm
 Inclinación - 5°

Zamak
 ZINCADO

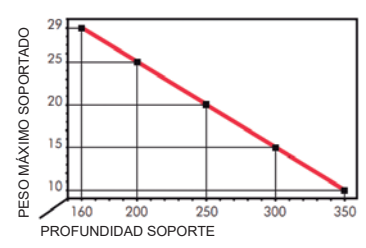

SOPORTE BALDA OCULTO SBO2



	Código	8431488	Medida	Acabado				€uros
Caja	31129	311296	150 mm	ZN	-	10	30	

Peso máx.: 25 Kgs

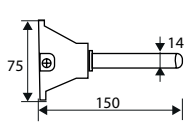

Regulación:
 Vertical - 5 mm
 Horizontal - 5 mm
 Inclinación - 5°

Zamak
 ZINCADO

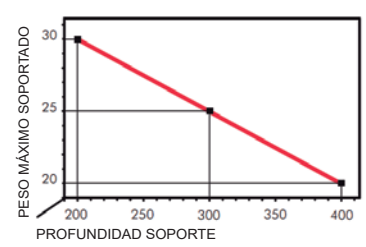

JGO SOPORTE AIRE ACONDICIONADO AC1

Código	8431488	Medida Ax B	Acabado				€uros
18516	185163	500x400 mm	BE	-	1	-	
18517	185170	500x450 mm	BE	-	1	-	
18518	185187	500x500 mm	BE	-	1	-	

Acero

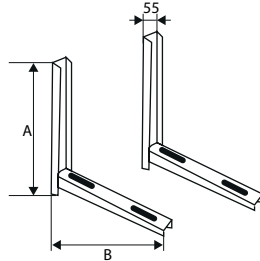

JGO AMORTIGUADORES AC2

Código	8431488	Peso	Acabado				€uros
18519	185194	35 kgs	NE	-	1	8	
18520	185200	45 kgs	NE	-	1	5	

Caucho



1 juego de 4 piezas

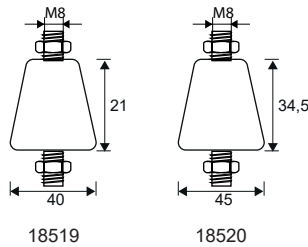

SOPORTE C/GARRAFA AIRE ACONDICIONADO AC3

Código	8431488	Medida	Acabado				€uros
18521	185217	290x195 mm	BE	-	1	5	

Acero



Incluye garrafa 5 litros

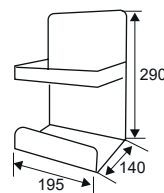

Te sugiero:



SOPORTE MICROONDAS
Pág. 343

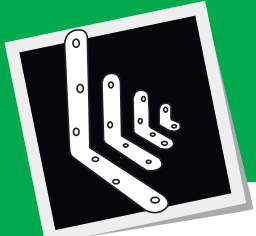

CREMALLERA PLM8

Código	843 I 488	Medida A	Acabado				€uros
51100	511009	1 mt	BL	-	1	25	
51150	511504	1,5 mts	BL	-	1	25	
51200	512006	2 mts	BL	-	1	25	
52100	521008	1 mt	PL	-	1	25	
52150	521503	1,5 mts	PL	-	1	25	
52200	522005	2 mts	PL	-	1	25	

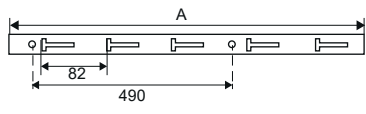

Aluminio
 BLANCO
 PLATA

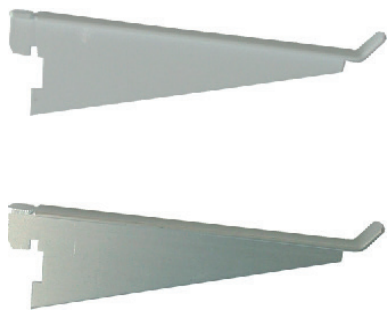

PALOMILLA PLM8

Código	843 I 488	Medida A	Acabado				€uros
50041	500416	150 mm	BL	2	-	50	
50042	500423	200 mm	BL	2	-	50	
50043	500430	250 mm	BL	2	-	50	
50044	500447	300 mm	BL	2	-	50	
50045	500454	350 mm	BL	2	-	50	
50046	500461	400 mm	BL	2	-	50	
<i>Blister</i>							
50047	500478	150 mm	PL	2	-	50	
50048	500485	200 mm	PL	2	-	50	
50049	500492	250 mm	PL	2	-	50	
50050	500508	300 mm	PL	2	-	50	
50051	500515	350 mm	PL	2	-	50	
50052	500522	400 mm	PL	2	-	50	

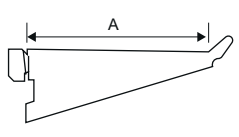

Aluminio
 BLANCO
 PLATA

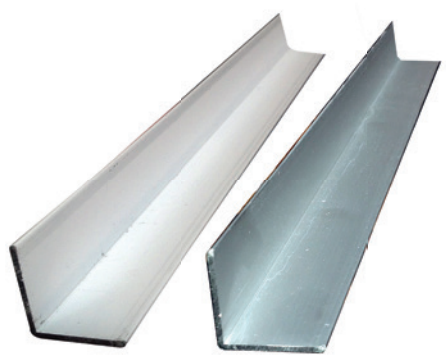

ESQUINERO AN23

Código	843 I 488	Medida AxBxC	Acabado				€uros
55062	550626	20x20x2,5 mts	BL	-	5	-	
55063	550633	20x20x2,5 mts	PL	-	5	-	
55064	550640	25x25x2,5 mts	BL	-	5	-	
55065	550657	25x25x2,5 mts	PL	-	5	-	

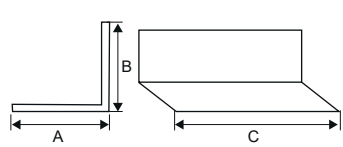

Aluminio
 BLANCO
 PLATA

PALOMILLA 3 POSICIONES PLM6

Código	8431488	Medida AxBxC	Acabado	Carga Máx				€uros
37330	373300	300x300x30 mm	BL	50 Kgs	-	10	40	
37340	373409	400x400x35 mm	BL	50 Kgs	-	6	12	
37430	374307	300x300x30 mm	CB	50 Kgs	-	10	40	
37440	374406	400x400x35 mm	CB	50 Kgs	-	6	12	

Acero

- BLANCO
- CROMO BRILLO

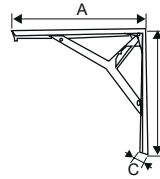

PALOMILLA ORNAMENTAL PLM5

Código	8431488	Medida AxB	Acabado	Carga Máx				€uros
33010	330105	100x90 mm	NE	75 Kgs	-	10	120	
33015	330150	150x115 mm	NE	75 Kgs	-	10	120	
33020	330204	200x150 mm	NE	100 Kgs	-	10	60	
33025	330259	250x190 mm	NE	100 Kgs	-	10	60	

Acero

- NEGRO

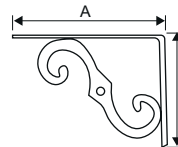

PALOMILLA REFORZADA PLM4

Código	8431488	Medida AxB	Acabado	Carga Máx				€uros
37525	375250	250x200 mm	BL	330 Kgs	-	10	-	
37530	375304	300x220 mm	BL	260 Kgs	-	10	-	
37540	375403	400x280 mm	BL	225 Kgs	-	10	-	
37550	375502	500x350 mm	BL	185 Kgs	-	10	-	
37560	375601	600x400 mm	BL	150 Kgs	-	10	-	
37625	376257	250x200 mm	GR	330 Kgs	-	10	-	
37630	376301	300x220 mm	GR	260 Kgs	-	10	-	
37640	376400	400x280 mm	GR	225 Kgs	-	10	-	
37650	376509	500x350 mm	GR	185 Kgs	-	10	-	
37660	376608	600x400 mm	GR	150 Kgs	-	10	-	

Acero

- BLANCO
- GRIS

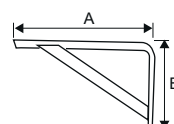

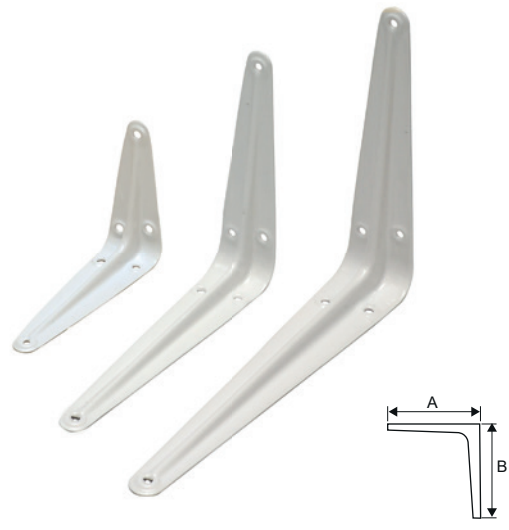
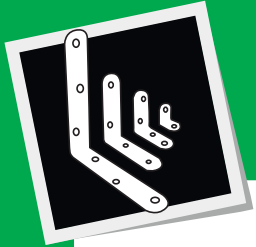

PALOMILLA CLÁSICA PLM1

Código	8431488	Medida AxB	Acabado	Carga Máx				€uros
80100	801001	100x75 mm	BL	20 Kgs	-	20	400	
80125	801254	125x100 mm	BL	20 Kgs	-	20	400	
80150	801506	150x125 mm	BL	20 Kgs	-	20	400	
80175	801759	175x150 mm	BL	25 Kgs	-	20	400	
80200	802008	200x150 mm	BL	25 Kgs	-	20	200	
80250	802503	250x200 mm	BL	30 Kgs	-	20	200	
80300	803005	300x250 mm	BL	30 Kgs	-	20	100	
80350	803500	350x300 mm	BL	35 Kgs	-	20	100	
80400	804002	400x350 mm	BL	40 Kgs	-	20	80	
80450	804507	450x400 mm	BL	40 Kgs	-	20	80	

Acero

PALOMILLA PLUS PLM2

Código	8431488	Medida AxB	Acabado	Carga Máx				€uros
80453	804538	150x125 mm	BL	30 Kgs	-	20	160	
80454	804545	200x150 mm	BL	30 Kgs	-	20	140	
80455	804552	250x200 mm	BL	30 Kgs	-	20	100	
80456	804569	300x250 mm	BL	30 Kgs	-	20	60	
80457	804576	350x300 mm	BL	30 Kgs	-	20	60	
80458	804583	150x125 mm	NE	30 Kgs	-	20	160	
80459	804590	200x150 mm	NE	30 Kgs	-	20	140	
80460	804606	250x200 mm	NE	30 Kgs	-	20	100	
80461	804613	300x250 mm	NE	30 Kgs	-	20	60	
80462	804620	350x300 mm	NE	30 Kgs	-	20	60	
80463	804637	150x125 mm	GR	30 Kgs	-	20	160	
80464	804644	200x150 mm	GR	30 Kgs	-	20	140	
80465	804651	250x200 mm	GR	30 Kgs	-	20	100	
80466	804668	300x250 mm	GR	30 Kgs	-	20	60	
80467	804675	350x300 mm	GR	30 Kgs	-	20	60	

Acero
BLANCO NEGRO GRIS

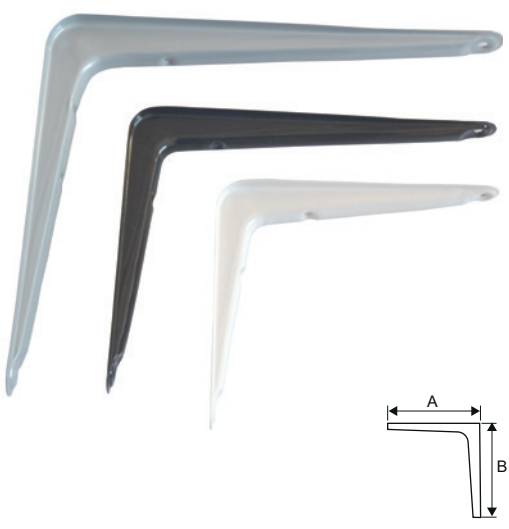

PALOMILLA PLM7

Código	8431488	Medida AxB	Acabado	Carga Máx				€uros
80468	804682	150x100 mm	BL	25 Kgs	-	25	200	
80469	804699	200x150 mm	BL	25 Kgs	-	20	200	
80470	804705	250x200 mm	BL	25 Kgs	-	10	100	
80471	804712	300x200 mm	BL	25 Kgs	-	10	100	
80472	804729	150x100 mm	NE	25 Kgs	-	25	200	
80473	804736	200x150 mm	NE	25 Kgs	-	20	200	
80474	804743	250x200 mm	NE	25 Kgs	-	10	100	
80475	804750	300x200 mm	NE	25 Kgs	-	10	100	
80476	804767	150x100 mm	GR	25 Kgs	-	25	200	
80477	804774	200x150 mm	GR	25 Kgs	-	20	200	
80478	804781	250x200 mm	GR	25 Kgs	-	10	100	
80479	804798	300x200 mm	GR	25 Kgs	-	10	100	

Aluminio
BLANCO NEGRO GRIS

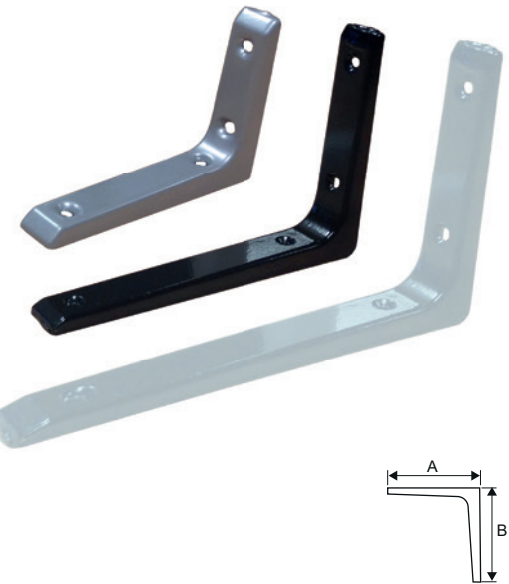

PALOMILLA SUPER PLM3

Código	8431488	Medida AxB	Acabado	Carga Máx				€uros
35101	351018	125x125 mm	BL	50 Kgs	-	25	250	
35102	351025	150x125 mm	BL	25 Kgs	-	25	150	
35103	351032	200x150 mm	BL	30 Kgs	-	20	100	
35104	351049	250x200 mm	BL	35 Kgs	-	10	50	
35105	351056	300x250 mm	BL	40 Kgs	-	10	40	
35106	351063	350x250 mm	BL	45 Kgs	-	6	18	
35107	351070	400x300 mm	BL	50 Kgs	-	6	12	



Acero

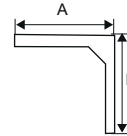

BLANCO



ÁNGULO SUPER AN3

Código	8431488	Medida AxB	Acabado				€uros
35030	350301	30x30 mm	BL	-	100	1000	
35050	350509	50x50 mm	BL	-	100	500	
35075	350752	75x75 mm	BL	-	50	500	
35100	351001	100x100 mm	BL	-	50	500	
36030	360300	30x30 mm	NE	-	100	1000	
36050	360508	50x50 mm	NE	-	100	500	
36075	360751	75x75 mm	NE	-	50	500	
36100	361000	100x100 mm	NE	-	50	500	
35530	355306	30x30 mm	ZN	-	100	1000	
35550	355504	50x50 mm	ZN	-	100	500	
35575	355757	75x75 mm	ZN	-	50	500	
35510	355108	100x100 mm	ZN	-	50	500	
91024	982236	30x30 mm	BL	-	100	100	
91025	982243	50x50 mm	BL	-	100	100	
91026	982250	75x75 mm	BL	-	50	50	
91027	982267	100x100 mm	BL	-	50	50	
91028	982274	30x30 mm	ZN	-	100	100	
91029	982281	50x50 mm	ZN	-	100	100	
91030	982298	75x75 mm	ZN	-	50	50	
91031	982304	100x100 mm	ZN	-	50	50	
90444	904443	30x30 mm	BL	4	-	10	
90446	904467	50x50 mm	BL	4	-	10	
90448	904481	75x75 mm	BL	4	-	10	
90658	906584	100x100 mm	BL	4	-	10	
90445	904450	30x30 mm	NE	4	-	10	
90447	904474	50x50 mm	NE	4	-	10	
90449	904498	75x75 mm	NE	4	-	10	
90659	906591	100x100 mm	NE	4	-	10	
92375	923758	30x30 mm	ZN	4	-	10	
92376	923765	50x50 mm	ZN	4	-	10	
92377	923772	75x75 mm	ZN	4	-	10	
92378	923789	100x100 mm	ZN	4	-	10	

Acero



BLANCO



NEGRO



ZINCADO

 Incluye tornillos en el blíster

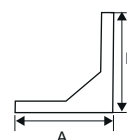

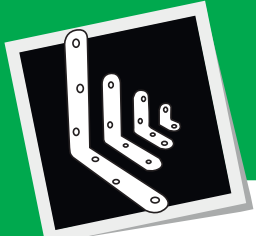

ÁNGULO REFUERZO AN1



	Código	843 1488	Medida AxBxC	Acabado				€uros
Caja	39020	390208	20x20x19 mm	BC	-	100	1200	
	39030	390307	30x30x19 mm	BC	-	100	1200	
	39040	390406	40x40x19 mm	BC	-	100	1200	
	39050	390505	50x50x19 mm	BC	-	100	700	
	39060	390604	60x60x19 mm	BC	-	100	700	
	39080	390802	80x80x19 mm	BC	-	100	500	
	39100	391007	100x100x19 mm	BC	-	50	250	
	91000	982137	20x20x19 mm	BC	-	100	1200	
	91001	982144	30x30x19 mm	BC	-	100	1200	
	91002	982151	40x40x19 mm	BC	-	100	1200	
	91003	982168	50x50x19 mm	BC	-	100	700	
	91004	982175	60x60x19 mm	BC	-	100	700	
	91005	977515	80x80x19 mm	BC	-	100	500	
	91006	981697	100x100x19 mm	BC	-	50	250	
Blister	90433	904337	20x20x19 mm	BC	4	-	10	
	90434	904344	30x30x19 mm	BC	4	-	10	
	90435	904351	40x40x19 mm	BC	4	-	10	
	90436	904368	50x50x19 mm	BC	4	-	10	
	90437	904375	60x60x19 mm	BC	4	-	10	
	90438	904382	80x80x19 mm	BC	4	-	10	
	90655	906553	100x100x19 mm	BC	4	-	10	

Incluye tornillos en el blister
Espesor 2 mm

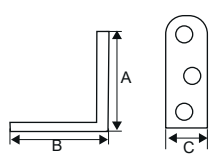

Acero
 BICROMATADO



Presentación
Bolsa de 10 unidades

ÁNGULO REFUERZO AN1



	Código	843 1488	Medida AxBxC	Acabado				€uros
Caja	39000	390000	20x20x19 mm	BL	-	100	2500	
	39001	390017	30x30x19 mm	BL	-	100	1000	
	39002	390024	40x40x19 mm	BL	-	100	1000	
	39003	390031	50x50x19 mm	BL	-	100	100	
	39004	390048	60x60x19 mm	BL	-	100	100	
	91624	982182	20x20x19 mm	BL	-	100	2500	
	91625	982199	30x30x19 mm	BL	-	100	1000	
	91626	982205	40x40x19 mm	BL	-	100	1000	
	91627	982212	50x50x19 mm	BL	-	100	500	
	91628	982229	60x60x19 mm	BL	-	100	500	
	Blister	91140	911403	20x20x19 mm	BL	4	-	10
91141		911410	30x30x19 mm	BL	4	-	10	
91142		911427	40x40x19 mm	BL	4	-	10	
91143		911434	50x50x19 mm	BL	4	-	10	
91144		911441	60x60x19 mm	BL	4	-	10	

Incluye tornillos en el blister
Espesor 2 mm

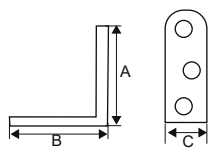

Acero
 BLANCO

ÁNGULO REFUERZO AN2

	Código	8431488	Medida AxBxC	Acabado				€uros
Caja	39101	391014	20x20x15 mm	ZN	-	100	-	
	39102	391021	30x30x15 mm	ZN	-	100	-	
	39103	391038	40x40x15 mm	ZN	-	100	-	
	39104	391045	50x50x15 mm	ZN	-	100	-	
	39105	391052	60x60x15 mm	ZN	-	100	-	
	39106	391069	80x80x15 mm	ZN	-	100	-	
	39107	391076	100x100x15 mm	ZN	-	100	-	
	91082	982311	20x20x15 mm	ZN	-	100	-	
	91083	982328	30x30x15 mm	ZN	-	100	-	
	91084	982335	40x40x15 mm	ZN	-	100	-	
	91085	982342	50x50x15 mm	ZN	-	100	-	
	91086	982359	60x60x15 mm	ZN	-	100	-	
	91087	982366	80x80x15 mm	ZN	-	100	-	
	91088	982373	100x100x15 mm	ZN	-	100	-	
Blister	91122	911229	20x20x15 mm	ZN	4	-	10	
	91123	911236	30x30x15 mm	ZN	4	-	10	
	91124	911243	40x40x15 mm	ZN	4	-	10	
	91125	911250	50x50x15 mm	ZN	4	-	10	
	91126	911267	60x60x15 mm	ZN	4	-	10	
	91127	911274	80x80x15 mm	ZN	4	-	10	

Acero



ZINCADO

Incluye tornillos en el blister

Espesor 2 mm

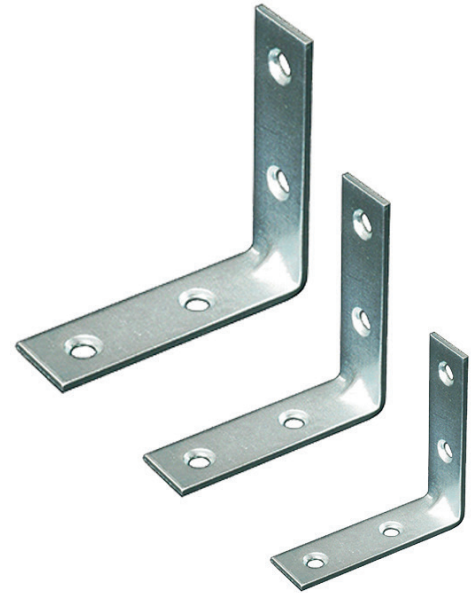
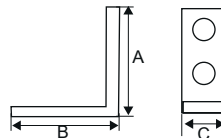

ÁNGULO REFUERZO AN4

	Código	8431488	Medida AxBxC	Acabado				€uros
	39121	981758	20x20x30 mm	ZN	-	50	-	
	39122	981765	30x30x30 mm	ZN	-	50	-	
	39123	981772	40x40x30 mm	ZN	-	50	-	
	39124	981789	50x50x30 mm	ZN	-	50	-	
	39125	981796	60x60x30 mm	ZN	-	50	-	

Acero



ZINCADO

Incluye tornillos en el blister

Espesor 2 mm

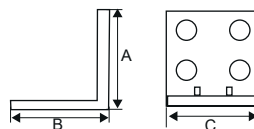

ÁNGULO FIJACIÓN AN10

	Código	8431488	Medida AxBxC	Acabado				€uros
	39131	981857	38x28x23 mm	ZN	-	100	-	
Blister	91139	911397	38x28x23 mm	ZN	4	-	10	

Acero



ZINCADO

Incluye tornillos en el blister

Espesor 2 mm

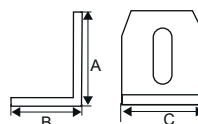

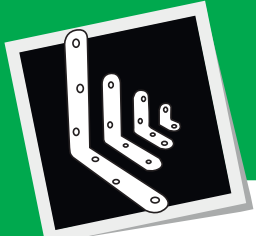

ÁNGULO FIJACIÓN AN11

Código	843 1488	Medida AxBxC	Acabado				€uros
39132	981864	28x28x30 mm	ZN	-	100	-	

Incluye tornillos en el blíster
Espesor 1 mm

Acero
 ZINCADO

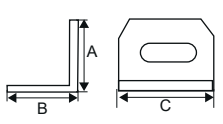

ÁNGULO REFUERZO AN5

Código	843 1488	Medida AxBxC	Acabado				€uros
39116	981666	20x20x40 mm	ZN	-	100	-	
Blister 91134	911342	20x20x40 mm	ZN	4	-	10	

Incluye tornillos en el blíster
Espesor 1 mm

Acero
 ZINCADO

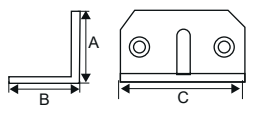

ÁNGULO REFUERZO AN6

Código	843 1488	Medida AxBxC	Acabado				€uros
39117	981703	20x20x50 mm	ZN	-	100	-	
Blister 91135	911359	20x20x50 mm	ZN	4	-	10	

Incluye tornillos en el blíster
Espesor 1 mm

Acero
 ZINCADO

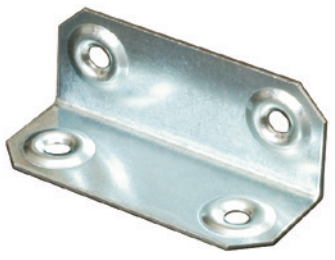
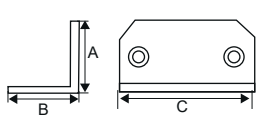

ÁNGULO REFUERZO AN7

Código	843 1488	Medida AxBxC	Acabado				€uros
39118	981710	21x21x67 mm	ZN	-	100	-	
Blister 91136	911366	21x21x67 mm	ZN	4	-	10	

Incluye tornillos en el blíster
Espesor 1 mm

Acero
 ZINCADO

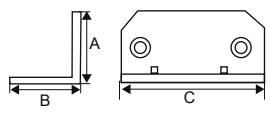

ÁNGULO REFUERZO AN8

Código	843 1488	Medida AxBxC	Acabado				€uros
39119	981727	21x21x86 mm	ZN	-	100	-	
Blister 91137	911373	21x21x86 mm	ZN	4	-	10	

Incluye tornillos en el blíster
Espesor 1 mm

Acero
 ZINCADO

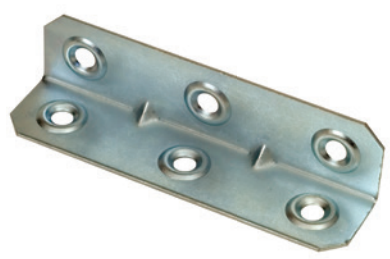
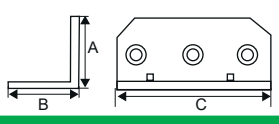

ÁNGULO REFUERZO AN9

	Código	8431488	Medida AxByC	Acabado				€uros
	39120	981741	40x40x90 mm	ZN	-	50	-	
<i>Blister</i>	91138	911380	40x40x90 mm	ZN	4	-	10	

Acero



ZINCADO

Incluye tornillos en el blister
Espesor 1 mm

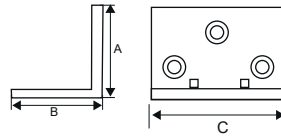

PLACA CUADRADA PLC6

	Código	8431488	Medida AxB	Acabado				€uros
	39114	981642	45x45 mm	ZN	-	100	-	
<i>Blister</i>	91132	911328	45x45 mm	ZN	4	-	10	

Acero



ZINCADO

Incluye tornillos en el blister
Espesor 1 mm

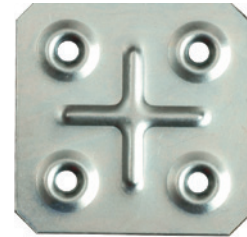
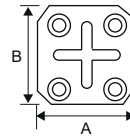

PLACA RECTANGULAR PLC7

	Código	8431488	Medida AxB	Acabado				€uros
	39115	981659	70x35 mm	ZN	-	100	-	
<i>Blister</i>	91133	911335	70x35 mm	ZN	4	-	10	

Acero



ZINCADO

Incluye tornillos en el blister
Espesor 1 mm

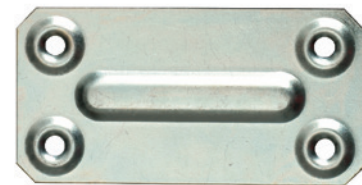
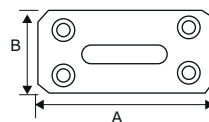

PLACA RECTA UNIÓN PLC8

	Código	8431488	Medida AxB	Acabado				€uros
	39126	981802	40x30 mm	ZN	-	50	-	
	39127	981819	60x30 mm	ZN	-	50	-	
	39128	981826	80x30 mm	ZN	-	50	-	
	39129	981833	100x30 mm	ZN	-	50	-	
	39130	981840	120x30 mm	ZN	-	50	-	

Acero



ZINCADO

Espesor 2 mm

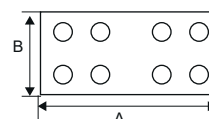

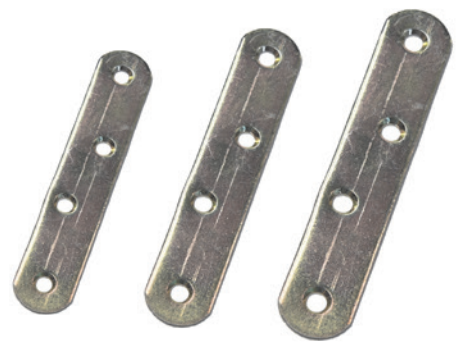
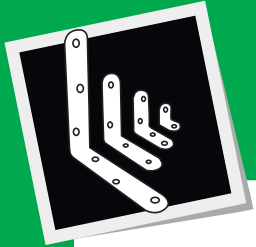

Espesor 1,5 mm		Espesor 2 mm	
38040-38060		38080-38100-38120	
91019-91020		91021-91022-91023	
90516-90517		90518-90519	

PLACA RECTA UNIÓN PLC1

	Código	8431488	Medida AxB	Acabado				€uros
Caja	38040	380407	40x16 mm	BC	-	100	1000	
	38060	380605	60x16 mm	BC	-	100	1000	
	38080	380803	80x19 mm	BC	-	100	500	
	38100	381008	100x19 mm	BC	-	100	500	
	38120	381206	120x19 mm	BC	-	100	500	
	91019	983547	40x16 mm	BC	-	100	1000	
	91020	982458	60x16 mm	BC	-	100	1000	
	91021	981680	80x19 mm	BC	-	100	500	
	91022	982496	100x19 mm	BC	-	100	500	
	91023	982434	120x19 mm	BC	-	100	500	
Blister	90516	905167	40x16 mm	BC	4	-	10	
	90517	905174	60x16 mm	BC	4	-	10	
	90518	905181	80x19 mm	BC	4	-	10	
	90519	905198	100x19 mm	BC	4	-	10	

Incluye tornillos en el blister

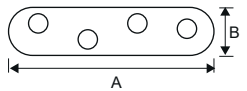

Acero
 BICROMATADO

PLACA RECTA UNIÓN PLC2

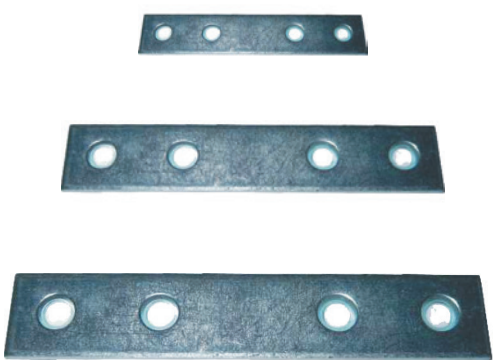

	Código	8431488	Medida AxB	Acabado				€uros
Caja	38240	382401	40x15 mm	ZN	-	100	-	
	38260	382609	60x15 mm	ZN	-	100	-	
	38280	382807	80x15 mm	ZN	-	100	-	
	38210	382104	100x15 mm	ZN	-	100	-	
	38212	382128	120x15 mm	ZN	-	100	-	
	91014	982410	40x15 mm	ZN	-	100	-	
	91015	982908	60x15 mm	ZN	-	100	-	
	91016	982885	80x15 mm	ZN	-	100	-	
	91017	982427	100x15 mm	ZN	-	100	-	
	91018	983523	120x15 mm	ZN	-	100	-	
Blister	90520	905204	40x15 mm	ZN	4	-	10	
	90521	905211	60x15 mm	ZN	4	-	10	
	90522	905228	80x15 mm	ZN	4	-	10	
	90523	905235	100x15 mm	ZN	4	-	10	

Incluye tornillos en el blister

Espesor 2 mm

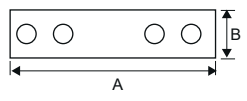

Acero
 ZINCADO

PLACA CARTELA PLC3

	Código	8431488	Medida AxB	Acabado				€uros
Caja	38130	381305	30x13 mm	ZN	-	300	3000	
	38140	381404	40x15 mm	ZN	-	200	2000	
	38150	381503	50x17 mm	ZN	-	200	2000	
	38160	381602	60x20 mm	ZN	-	100	1000	
Blister	90844	908441	30x13 mm	ZN	4	-	10	
	90845	908458	40x15 mm	ZN	4	-	10	
	90846	908465	50x17 mm	ZN	4	-	10	
	90847	908472	60x20 mm	ZN	4	-	10	

Acero



Incluye tornillos en el blíster
Espesor 1 mm

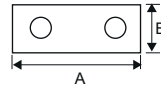

ESCUADRA PLANA PLC4

	Código	8431488	Medida AxB	Acabado				€uros
Caja	37030	370309	30x30x12 mm	BC	-	100	1000	
	37040	370408	40x40x12 mm	BC	-	100	1000	
	37051	370514	50x50x14 mm	BC	-	100	1000	
	37060	370606	60x60x15 mm	BC	-	100	500	
	37080	370804	80x80x17 mm	BC	-	100	500	
	37100	371009	100x100x17 mm	BC	-	100	500	
	37120	371207	120x120x17 mm	BC	-	100	500	
	91007	981734	30x30x12 mm	BC	-	100	1000	
	91008	983554	40x40x12 mm	BC	-	100	1000	
	91009	983462	50x50x14 mm	BC	-	100	1000	
	91010	983479	60x60x15 mm	BC	-	100	500	
	91011	983486	80x80x17 mm	BC	-	100	500	
	91012	982441	100x100x17 mm	BC	-	100	500	
	91013	983455	120x120x17 mm	BC	-	100	500	
Blister	90439	904399	30x30x12 mm	BC	8	-	10	
	90440	904405	40x40x12 mm	BC	8	-	10	
	90441	904412	50x50x14 mm	BC	4	-	10	
	90442	904429	60x60x15 mm	BC	4	-	10	
	90443	904436	80x80x17 mm	BC	4	-	10	
	90656	906560	100x100x17 mm	BC	4	-	10	
	90657	906577	120x120x17 mm	BC	4	-	10	

Acero



Incluye tornillos en el blíster

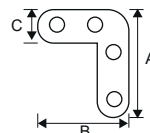
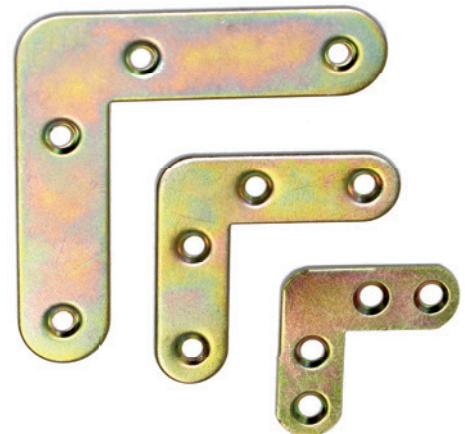

Espesor 0,9 mm	Espesor 1 mm	Espesor 1,2 mm
37030-37040-37051-37060	37080	37100-37120
91007-91008-91009-91010	91011	91012-91013
90439-90440-90441-90442	90443	90656-90657

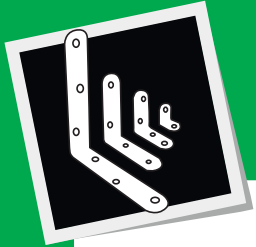

ESCUADRA PLANA PLC5



Espesor 1,8 mm		Espesor 2 mm	
39108-39109-39110		39111-39112-39113	
91089-91090-91091		91092-91093-91094	
91128-91129-91130		91131	

	Código	843 I 488	Medida AxBxC	Acabado				€uros
Caja	39108	391083	40x40x12 mm	ZN	-	100	-	
	39109	391090	50x50x12 mm	ZN	-	100	-	
	39110	391106	60x60x12 mm	ZN	-	100	-	
	39111	391113	80x80x18 mm	ZN	-	100	-	
	39112	391120	100x100x18 mm	ZN	-	50	-	
	39113	391137	120x120x18 mm	ZN	-	50	-	
	91089	983561	40x40x12 mm	ZN	-	100	-	
	91090	983578	50x50x12 mm	ZN	-	100	-	
	91091	983585	60x60x12 mm	ZN	-	100	-	
	91092	983592	80x80x18 mm	ZN	-	100	-	
	91093	983530	100x100x18 mm	ZN	-	50	-	
	91094	982915	120x120x18 mm	ZN	-	50	-	
Blister	91128	911281	40x40x12 mm	ZN	4	-	10	
	91129	911298	50x50x12 mm	ZN	4	-	10	
	91130	911304	60x60x12 mm	ZN	4	-	10	
	91131	911311	80x80x18 mm	ZN	4	-	10	

Incluye tornillos en el blister

Acero



ZINCADO

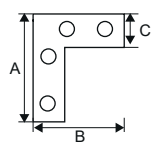

PLACA PESANTE PLC9



	Código	843 I 488	Medida Ax B	Acabado				€uros
	39134	981888	80x50 mm	ZN	-	50	-	
	39135	981895	120x50 mm	ZN	-	50	-	
	39136	981901	160x50 mm	ZN	-	25	-	
	39137	981918	200x50 mm	ZN	-	25	-	

Espesor 2,5 mm

Acero



ZINCADO

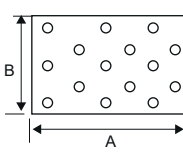

PLACA RECTA PERFORADA PLC10

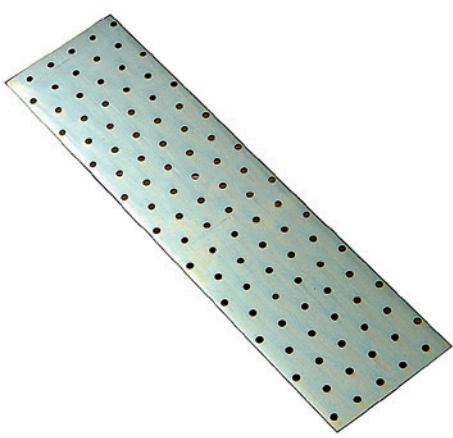

	Código	843 I 488	Medida Ax B	Acabado				€uros
	39156	982106	160x40 mm	ZN	-	50	-	
	39157	982113	200x60 mm	ZN	-	25	-	
	39158	982120	240x80 mm	ZN	-	25	-	

Espesor 2,5 mm

Acero



ZINCADO

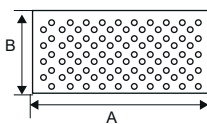

ÁNGULO PESANTE AN12

Código	8431488	Medida AxBxC	Acabado				€uros
39149	982038	40x40x20 mm	ZN	-	100	-	
39150	982045	40x40x40 mm	ZN	-	50	-	
39151	982052	50x50x40 mm	ZN	-	50	-	

Acero

Espesor 2 mm



ZINCADO

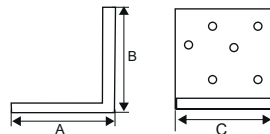

ÁNGULO PESANTE AN13

Código	8431488	Medida AxBxC	Acabado				€uros
39138	981925	40x40x50 mm	ZN	-	50	-	
39139	981932	60x60x50 mm	ZN	-	50	-	
39140	981949	80x80x50 mm	ZN	-	25	-	
39141	981956	100x100x50 mm	ZN	-	25	-	

Acero

Espesor 2 mm



ZINCADO

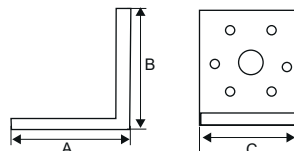

ÁNGULO PESANTE AN14

Código	8431488	Medida AxBxC	Acabado				€uros
39152	982069	60x60x40 mm	ZN	-	50	-	
39153	982076	60x60x60 mm	ZN	-	50	-	
39154	982083	60x60x80 mm	ZN	-	25	-	
39155	982090	80x80x80 mm	ZN	-	25	-	

Acero

Espesor 2 mm



ZINCADO

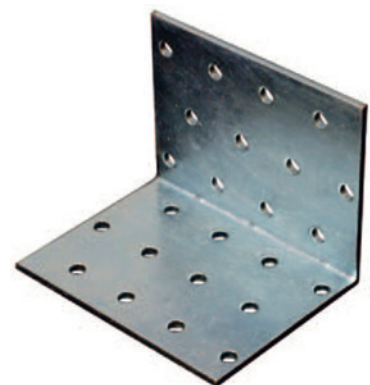
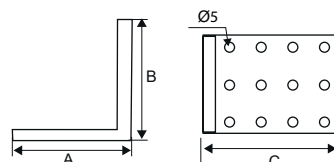

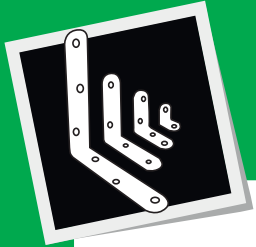

ÁNGULO PESANTE AN15



Código	843 1488	Medida	Acabado				€uros
39142	981963	60x60x50 mm	ZN	-	50	-	

Espesor 2,5 mm

Acero

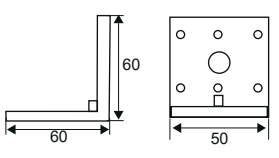

ÁNGULO PESANTE AN16



Código	843 1488	Medida	Acabado				€uros
39143	981970	85x85x65 mm	ZN	-	25	-	

Espesor 2,5 mm

Acero

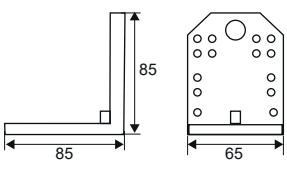

ÁNGULO PESANTE AN17



Código	843 1488	Medida	Acabado				€uros
39144	981987	100x100x90 mm	ZN	-	20	-	

Espesor 2,5 mm

Acero

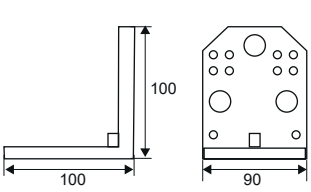

ÁNGULO PESANTE 135° AN18



Código	843 1488	Medida	Acabado				€uros
39145	981994	80x80x50 mm	ZN	-	25	-	

Espesor 2,5 mm

Acero

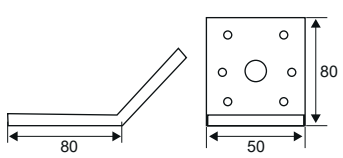

PLACA FORMA "T" PLC11

Código	8431488	Medida	Acabado				€uros
	39146	982007	160x45x100 mm	ZN	-	20	-

Acero



ZINCADO

Espesor 2,5 mm

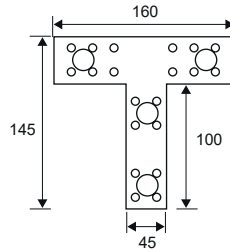

ÁNGULO ANCLAJE C/TORNILLO AN19

Código	8431488	Medida	Acabado				€uros
	39133	981871	30x36 mm	ZN	-	50	-

Acero



ZINCADO

Espesor 2 mm

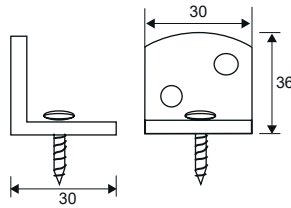

PLACA C/TUERCA PLC12

Código	8431488	Medida	Acabado				€uros
	39147	982014	M8x50x50 mm	ZN	-	50	-
	39148	982021	M10x50x50 mm	ZN	-	50	-
<i>Blister</i>	92205	922058	M8x50x50 mm	ZN	1	-	10
	92206	922065	M10x50x50 mm	ZN	1	-	10

Acero



ZINCADO

Espesor 3 mm

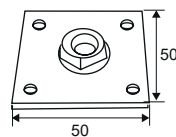

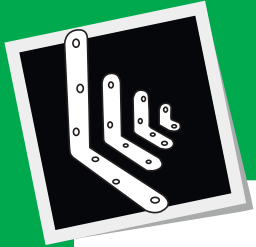

SOPORTE VIGA INCLINADO SV1

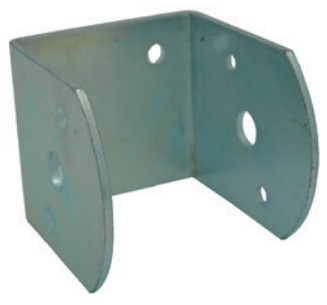

Código	8431488	Medida AxBxC	Acabado				€uros
39175	391755	70x70x80 mm	ZN	-	1	15	
39176	391762	90x90x95 mm	ZN	-	1	10	

Espesor 3 mm

Acero

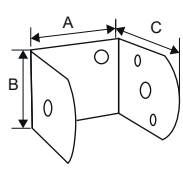

SOPORTE VIGA ABIERTO SV2



Código	8431488	Medida AxB	Acabado				€uros
39159	391595	70x125 mm	ZN	-	1	15	
39161	391618	80x120 mm	ZN	-	1	15	
39163	391632	100x140 mm	ZN	-	1	15	

Espesor 2 mm

Acero

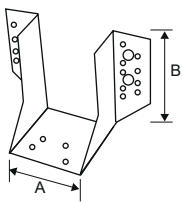

SOPORTE VIGA CERRADO SV3



Código	8431488	Medida AxB	Acabado				€uros
39160	391601	70x125 mm	ZN	-	1	15	
39162	391625	80x120 mm	ZN	-	1	15	
39164	391649	100x140 mm	ZN	-	1	15	

Espesor 2 mm

Acero

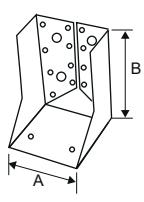

SOPORTE VIGA PIE SV4

Código	8431488	Medida AxB	Acabado				€uros
39166	391663	71x71 mm	ZN	-	1	4	
39167	391670	91x91 mm	ZN	-	1	4	
39169	391694	121x121 mm	ZN	-	1	4	

Acero

Espesor 4 mm



ZINCADO

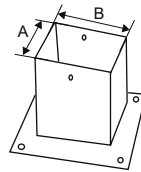

SOPORTE VIGA CLAVAR SV5

Código	8431488	Medida AxB	Acabado				€uros
39173	391731	70x70 mm	ZN	-	1	2	
39174	391748	90x90 mm	ZN	-	1	2	

Acero

Espesor 4 mm



ZINCADO

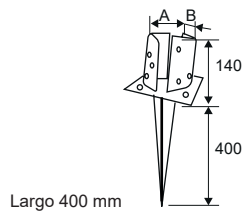

Largo 400 mm



SOPORTE POSTE SUELO SV8

Código	8431488	Medida A	Acabado				€uros
39179	391793	80 mm	ZN	-	1	4	
39180	391809	100 mm	ZN	-	1	4	
39181	391816	120 mm	ZN	-	1	4	

Acero

Espesor 4 mm



ZINCADO

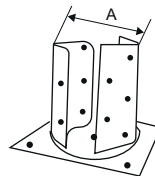

SOPORTE POSTE CLAVAR SV9

Código	8431488	Medida A	Acabado				€uros
39182	391823	80 mm	ZN	-	1	2	
39183	391830	100 mm	ZN	-	1	2	

Acero

Espesor 4 mm



ZINCADO

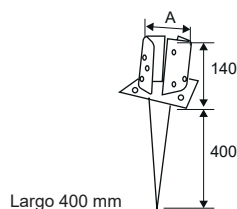

Largo 400 mm



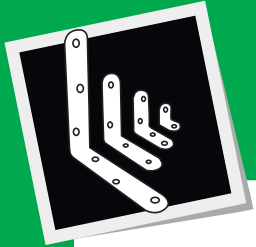

SOPORTE POSTE REDONDO SV6



Código	8431488	Medida	Acabado				€uros
39177	391779	80-100 mm	ZN	-	1	25	

Espesor 2,5 mm

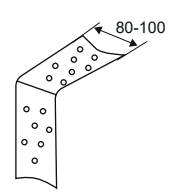

Acero

 ZINCADO

SOPORTE POSTE REDONDO SV7



Código	8431488	Medida	Acabado				€uros
39178	391786	80-100 mm	ZN	-	1	25	

Espesor 2,5 mm

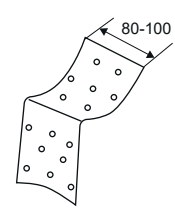

Acero

 ZINCADO