

MULETILLA CORREDERA CB21



Código	8431488	Medida	Acabado				€uros
54522	545226	118x50 mm	INOX	-	1	50	

Incluye tornillos
Cuadradillo 6 mm

Acero Inoxidable

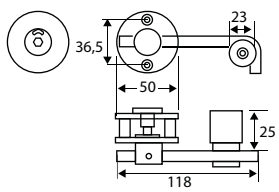

MULETILLA MINUSVÁLIDO CB11



Código	8431488	Medida	Acabado				€uros
10097	100975	50 mm	INOX	-	1	5	

Incluye tornillos
Cuadradillo 6 mm

Acero Inoxidable

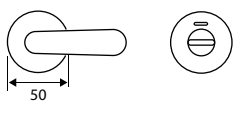

MULETILLA ROSETA C/INDICADOR CB1



Código	8431488	Medida	Acabado				€uros
54501	545011	63 mm	INOX	-	1	5	

AISI 316							
Código	8431488	Medida	Acabado				€uros
54568	545684	63 mm	INOX	-	1	5	

Incluye tornillos
Cuadradillo 6 mm

54501: Acero Inoxidable
54568: Acero inoxidable AISI 316

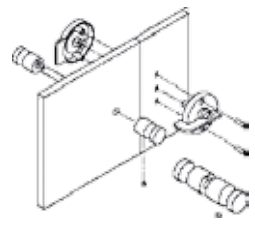
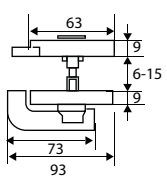

JGO POMOS CB4



Código	8431488	Medida	Acabado				€uros
54504	545042	25 mm	INOX	-	1	10	

M10
Incluye llave allen

Acero Inoxidable

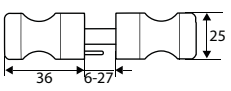

Válido para tablero fenólico de 13 mm

BISAGRA PLANA S/MUELLE CB2

Código	8431488	Medida	Acabado				€uros
54502	545028	90x52 mm	INOX	-	1	10	

Acero Inoxidable



Espesor 2 mm

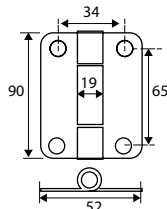

BISAGRA PLANA C/MUELLE CB3

Código	8431488	Medida	Acabado				€uros
54503	545035	90x52 mm	INOX	-	1	10	

Acero Inoxidable



Incluye llave allen
Espesor 2 mm

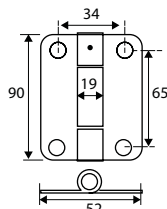

BISAGRA PLANA C/MUELLE CB26

Código	8431488	Medida	Acabado				€uros
54526	545264	77x76 mm	INOX	-	1	6	

Acero Inoxidable



Incluye tapas embellecedoras, llave allen y tornillos
Espesor 2 mm

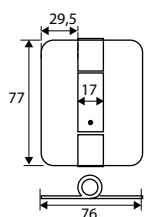

BISAGRA TAQUILLA CB28

Código	8431488	Medida	Acabado				€uros
54570	545707	77x67 mm	INOX	-	1	20	

Acero Inoxidable



Espesor 2 mm

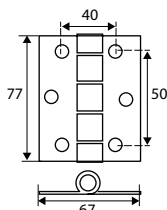

Válido para tablero fenólico de 13 mm



Te sugiero:

CERRADURA C/COMBINACIÓN
Pág. 245



CERRADURA TAQUILLA
Pág. 241



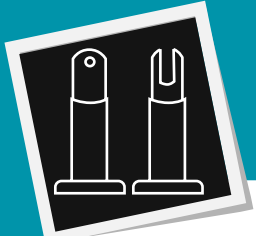

PATA REGULABLE CB10



Código	8431488	Medida	Acabado				€uros
54510	545103	110/180 mm	INOX	-	1	5	
54566	545660	210/370 mm	INOX	-	1	5	

AISI 316							
Código	8431488	Medida	Acabado				€uros
54567	545677	110/180 mm	INOX	-	1	5	

54510-54566: Acero Inoxidable
54567: Acero inoxidable AISI 316

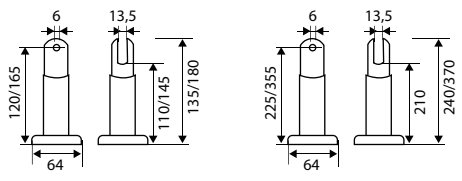

54567-54510 54566



PERCHA TOPE GOMA PER18

Código	8431488	Medida	Acabado				€uros
54513	545134	50x70 mm	INOX	-	1	10	

Incluye tornillos Acero Inoxidable

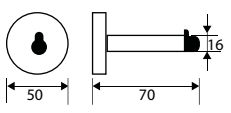

PINZA UNIÓN TUBO PANEL CB7

Código	8431488	Medida	Acabado				€uros
54507	545073	32,5x110 mm	INOX	-	1	10	

Incluye tornillos Acero Inoxidable
Espesor 3 mm

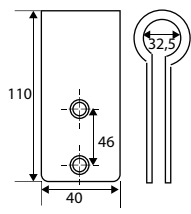

Válido para tablero fenólico de 13 mm

Te sugiero:

PERCHAS

Pág. 336-337-338

SOPORTE TUBO PARED CB5

Código	8431488	Medida	Acabado				€uros
54505	545059	65 mm	INOX	-	1	10	

Acero Inoxidable

Incluye tornillos

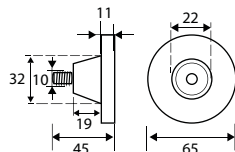

NUDO CONECTOR TUBO CB6

Código	8431488	Tipo - Medida	Acabado				€uros
54506	545066	2 agujeros (90°) - 44 mm	INOX	-	1	10	
54511	545110	3 agujeros (180°) - 44 mm	INOX	-	1	10	

Acero Inoxidable

Incluye llave allen

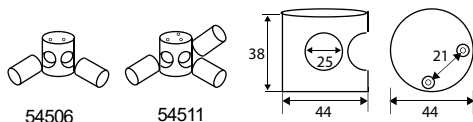

ÁNGULO CONECTOR TUBO CB27

Código	8431488	Medida	Acabado				€uros
54569	545691	25 mm	INOX	-	1	10	

Acero Inoxidable

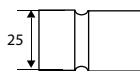

EMPALME UNIÓN TUBO CB20

Código	8431488	Medida	Acabado				€uros
54520	545202	25 mm	INOX	-	1	10	

Acero Inoxidable

Incluye llave allen

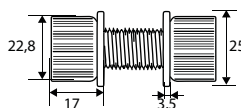

TUBO CABINA CB9

Código	8431488	Medida A	Acabado				€uros
54509	545097	Ø25x2 mts	INOX	-	1	-	
54519	545196	Ø25x3 mts	INOX	-	1	-	

Acero Inoxidable

Espesor 1,5 mm

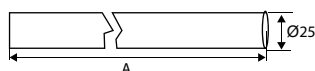

Válido para tablero fenólico de 13 mm

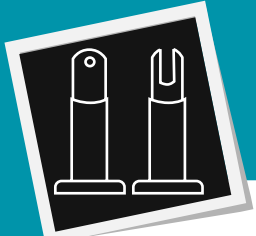

ESCUADRA 90° UNIÓN PANEL CB8



Código	8431488	Medida	Acabado				€uros
54508	545080	43,5x40 mm	INOX	-	1	20	

Incluye tornillos
Espesor 3 mm

Acero Inoxidable

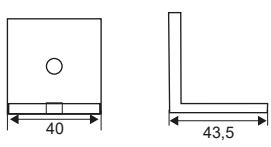

PINZA UNIÓN LATERAL CB12



Código	8431488	Medidas	Acabado				€uros
54512	545127	50x50 mm	INOX	-	1	10	

Incluye tornillos
Espesor 2 mm

Acero Inoxidable

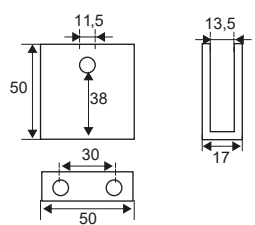

PINZA ESCUADRA UNIÓN "TU" CB17



Código	8431488	Medidas	Acabado				€uros
54517	545172	50x50 mm	INOX	-	1	10	

Incluye tornillos
Espesor 2 mm

Acero Inoxidable

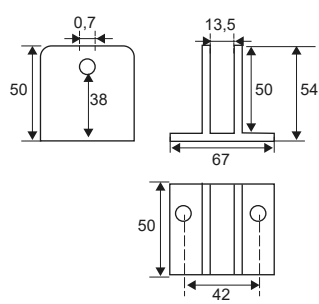

PINZA ESCUADRA UNIÓN "LU" CB18



Código	8431488	Medida	Acabado				€uros
54518	545189	50x50 mm	INOX	-	1	10	

Incluye tornillos
Espesor 2 mm

Acero Inoxidable

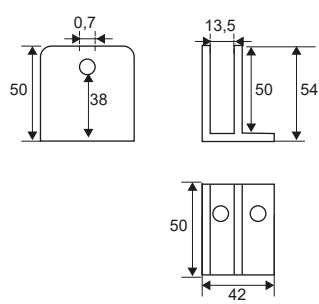

Válido para tablero fenólico de 13 mm

PERFILES CABINA INOX CB13/ CB14/ CB15

Código	8431488	Tipo - Medida	Acabado				€uros
54514	545141	"L" interior - 1800 mm	INOX	-	1	-	
54515	545158	"L" exterior - 1800 mm	INOX	-	1	-	
54516	545165	"U" arranque - 1800 mm	INOX	-	1	-	

Acero Inoxidable

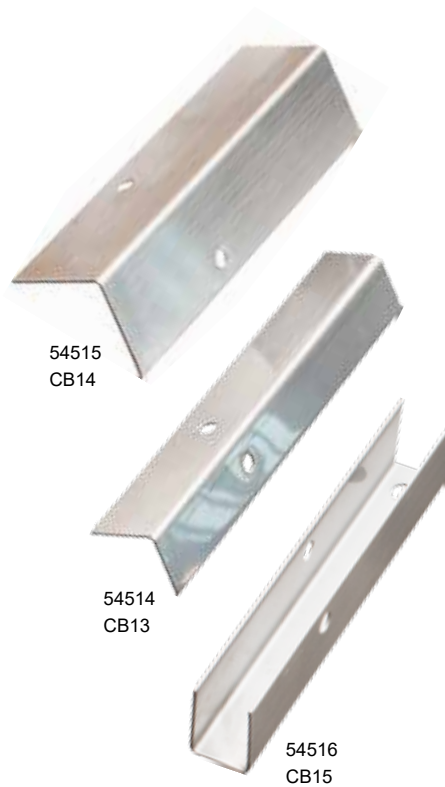
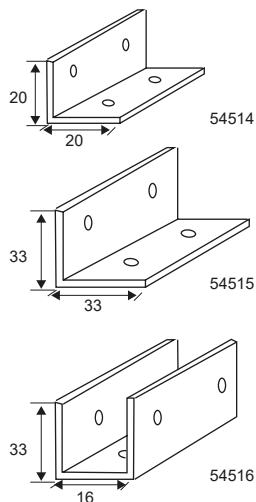
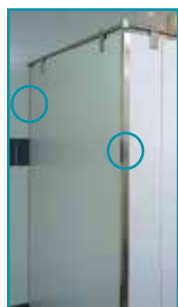

PERFILES CABINA ALUMINIO CB19/CB15/CB16

Código	8431488	Tipo - Medida	Acabado				€uros
54524	545240	Superior - 3950 mm	AL	-	1	10	
54525	545257	"U" arranque - 1800 mm	AL	-	1	20	
54565	545653	Esquinero - 1800 mm	AL	-	1	10	

Aluminio

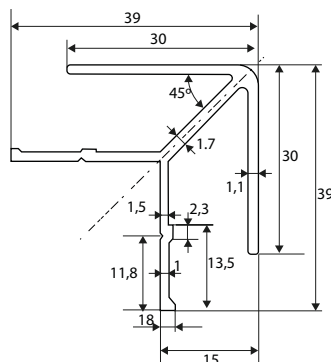
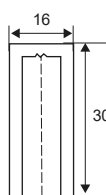
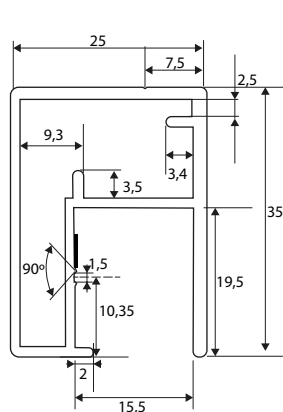

54524



54525



54565

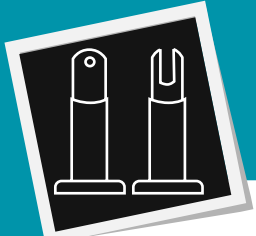

KIT CABINA SANITARIA CORREDERA CB21



	Código	8431488	Medida	Acabado				€uros
Caja	54521	545219	-	INOX	-	1	10	

Acero Inoxidable

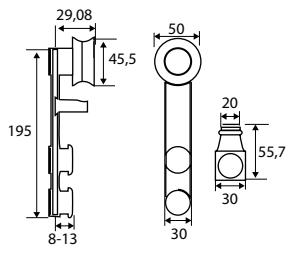

GUÍA INFERIOR CORREDERA CB21



	Código	8431488	Medida	Acabado				€uros
	54523	545233	50x37 mm	INOX	-	1	5	

Incluye tornillos

Acero Inoxidable

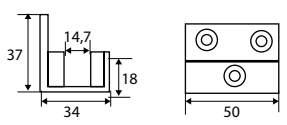

TORNILLO PERFILES Y BISAGRAS CABINA CB25



	Código	8431488	Medidas A	Acabado				€uros
Caja	40111	401119	3,5x12,5 mm	INOX	-	100	2.500	
	40107	401072	3,5x14 mm	INOX	-	100	2.500	

Acero Inoxidable

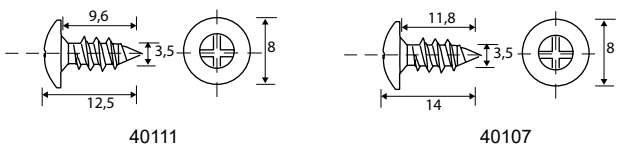

TORNILLO PASANTE CABINA CB22/CB23/CB24



	Código	8431488	Medida A	Acabado				€uros
Caja	40103	401034	12,5 - 18 mm	INOX	-	100	2.500	
	40104	401041	12 - 16 mm	INOX	-	100	2.500	
	40110	401102	18 - 21 mm	INOX	-	100	2.500	

Acero Inoxidable

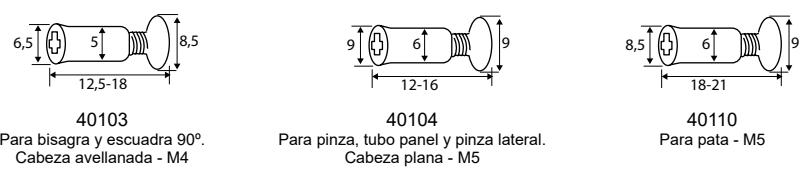

40103
Para bisagra y escuadra 90°. Cabeza avellanada - M4

40104
Para pinza, tubo panel y pinza lateral. Cabeza plana - M5

40110
Para pata - M5

Válido para tablero fenólico de 13 mm

CERRADURA CRISTAL "U" CCR1 S/CILINDRO

	Código	8431488	Medida	Acabado			€uros
Caja	54529	545295	160x65,5 mm	INOX	-	1 10	
	54530	545301	160x65,5 mm	NE	-	1 10	

INOX: Acero Inoxidable
NE: Aluminio

No incluye cilindro

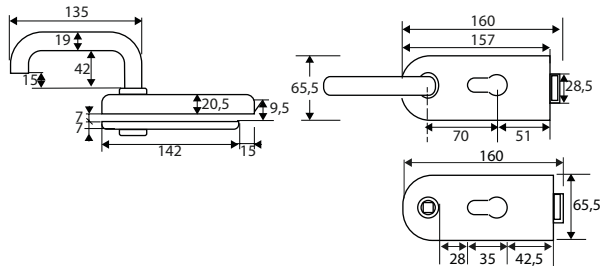

PICAPORTE CRISTAL "U" CCR3

	Código	8431488	Medida	Acabado			€uros
Caja	54533	545332	160x65,5 mm	INOX	-	1 10	
	54534	545349	160x65,5 mm	NE	-	1 10	

INOX: Acero Inoxidable
NE: Aluminio

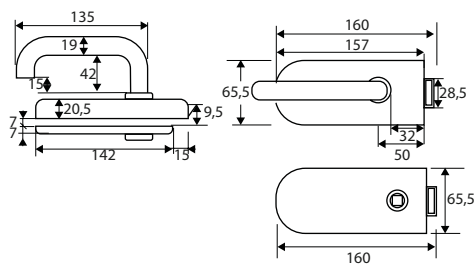

CERRADERO CRISTAL CCR2

	Código	8431488	Medida	Acabado			€uros
Caja	54531	545318	74x65,5 mm	INOX	-	1 50	
	54532	545325	74x65,5 mm	NE	-	1 50	

INOX: Acero Inoxidable
NE: Aluminio

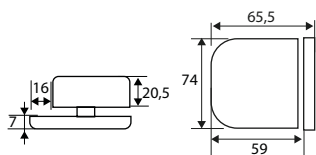

BISAGRA PARED-CRISTAL 180° BSC1

	Código	8431488	Medida	Acabado			€uros
Caja	54527	545271	102x50 mm	EI	-	1 24	
	54528	545288	102x50 mm	NE	-	1 24	

Aluminio

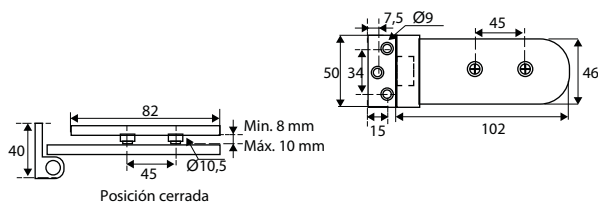

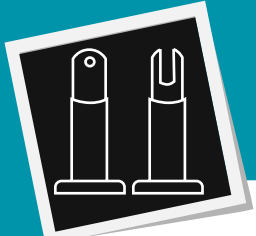

BISAGRA MAMPARA FIJA BSC2



	Código	8431488	Medida	Acabado				€uros
Caja	54536	545363	90x55 mm	INOX	-	1	30	
	54547	545479	90x55 mm	CB	-	1	20	

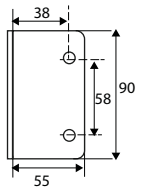

INOX: Acero Inoxidable
CB: Zamak



BISAGRA MAMPARA 90° S/ACCIÓN BSC3



	Código	8431488	Medida	Acabado				€uros
Caja	54537	545370	90x55 mm	INOX	-	1	30	
	54548	545486	90x55 mm	CB	-	1	30	

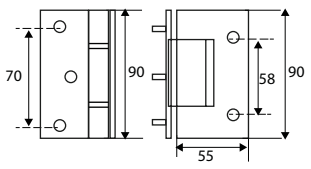

INOX: Acero Inoxidable
CB: Zamak



BISAGRA MAMPARA 90° D/ACCIÓN BSC4



	Código	8431488	Medida	Acabado				€uros
Caja	54538	545387	90x55 mm	INOX	-	1	30	
	54549	545493	90x55 mm	CB	-	1	30	

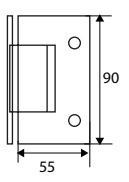

INOX: Acero Inoxidable
CB: Zamak



BISAGRA MAMPARA 90° D/ACCIÓN BSC5



	Código	8431488	Medida	Acabado				€uros
Caja	54539	545394	90x55 mm	INOX	-	1	30	
	54550	545509	90x55 mm	CB	-	1	30	

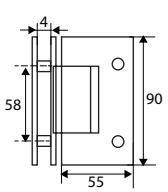

INOX: Acero Inoxidable
CB: Zamak



BISAGRA MAMPARA 135° D/ACCIÓN BSC6

	Código	8431488	Medida	Acabado				€uros
Caja	54540	545400	90x55 mm	INOX	-	1	30	
	54551	545516	90x55 mm	CB	-	1	30	

INOX: Acero Inoxidable
CB: Zamak

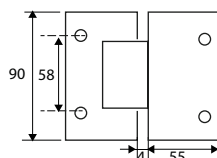

BISAGRA MAMPARA 180° D/ACCIÓN BSC7

	Código	8431488	Medida	Acabado				€uros
Caja	54541	545417	90x55 mm	INOX	-	1	30	
	54552	545523	90x55 mm	CB	-	1	20	

INOX: Acero Inoxidable
CB: Zamak

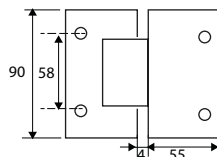

PINZA MAMPARA PARED-CRISTAL BSC15

	Código	8431488	Medida	Acabado				€uros
Caja	54556	545561	44 mm	INOX	-	10	100	
	54560	545608	44 mm	CB	-	10	100	

INOX: Acero Inoxidable
CB: Zamak

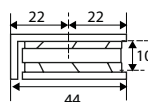

ÁNGULO MAMPARA 90° PARED-CRISTAL BSC16

	Código	8431488	Medida	Acabado				€uros
Caja	54557	545578	44x44 mm	INOX	-	10	100	
	54561	545615	44x44 mm	CB	-	10	100	

INOX: Acero Inoxidable
CB: Zamak

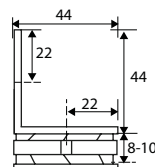

ÁNGULO MAMPARA 90° CRISTAL-CRISTAL BSC17

	Código	8431488	Medida	Acabado				€uros
Caja	54558	545585	44x44 mm	INOX	-	10	100	
	54562	545622	44x44 mm	CB	-	10	100	

INOX: Acero Inoxidable
CB: Zamak

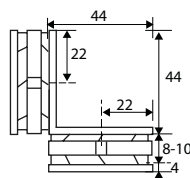

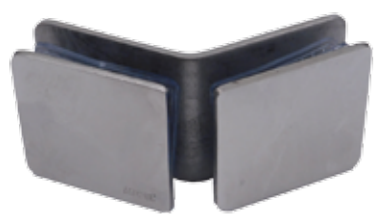
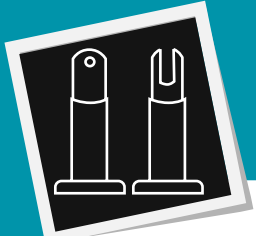

ÁNGULO MAMPARA 135° CRISTAL-CRISTAL BSC19

	Código	8431488	Medida	Acabado				€uros
Caja	54559	545592	44x44 mm	INOX	-	10	100	
	54564	545646	44x44 mm	CB	-	10	100	

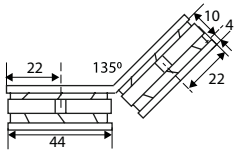

INOX: Acero Inoxidable
CB: Zamak

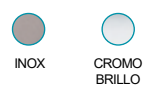

ÁNGULO MAMPARA 180° CRISTAL-CRISTAL BSC18

	Código	8431488	Medida	Acabado				€uros
Caja	54571	545714	90 mm	INOX	-	10	100	
	54563	545639	90 mm	CB	-	10	100	

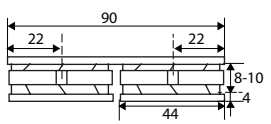

INOX: Acero Inoxidable
CB: Zamak



TUBO MAMPARA EXTENSIBLE BSC10

	Código	8431488	Medida A	Acabado				€uros
Caja	54544	545448	600-800 mm	INOX	-	1	25	
	54545	545455	800-1000 mm	INOX	-	1	25	

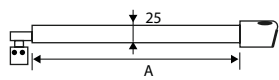

Acero Inoxidable



ÁNGULO CONECTOR TUBO MAMPARA BSC20

	Código	8431488	Medida	Acabado				€uros
Caja	54543	545431	25 mm	INOX	-	1	50	

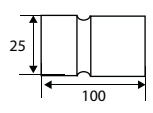

Acero Inoxidable



SOPORTE TUBO MAMPARA BSC11

	Código	8431488	Medida	Acabado				€uros
Caja	54546	545462	25 mm	INOX	-	1	100	

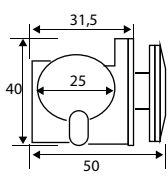

Acero Inoxidable



JGO POMO MAMPARA BSC12

	Código	8431488	Medida	Acabado				€uros
Caja	54553	545530	37x20 mm	CB	-	1	100	
Blister	92276	922768	37x20 mm	CB	1	-	10	



Zamak

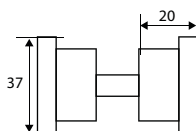

CROMO BRILLO



JGO POMO MAMPARA BSC13

	Código	8431488	Medida	Acabado				€uros
Caja	54554	545547	30x28 mm	CB	-	1	50	
Blister	92277	922775	30x28 mm	CB	1	-	10	



Zamak

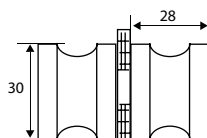

CROMO BRILLO



JGO POMO MAMPARA BSC14

	Código	8431488	Medida	Acabado				€uros
Caja	54555	545554	30x30 mm	CB	-	1	50	
Blister	92278	922782	30x30 mm	CB	1	-	10	



Zamak

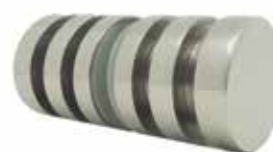
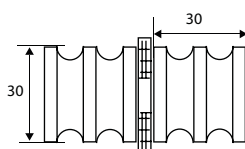

CROMO BRILLO



JGO TIRADOR EMBUTIR MAMPARA BSC8

	Código	8431488	Medida	Acabado				€uros
Caja	54542	545424	50 mm	INOX	-	1	100	
Blister	92275	922751	50 mm	INOX	1	-	10	

Acero Inoxidable



INOX

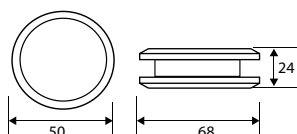

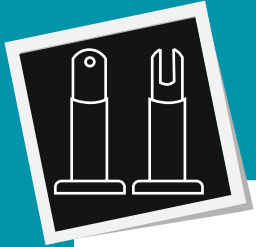

PERFIL MAMPARA BURBUJA PF3



Código	8431488	Cristal	Acabado				€uros
18525	185255	6/8 mm	TR	-	8	-	
18526	185262	8/10 mm	TR	-	8	-	

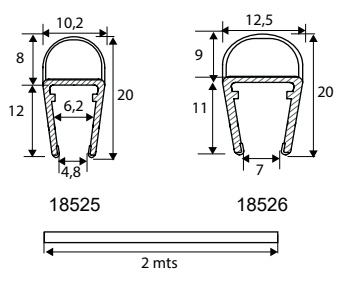

PVC

 TRANSPARENTE

PERFIL MAMPARA BAÑERA PF4



Código	8431488	Cristal	Acabado				€uros
18527	185279	6/8 mm	TR	-	8	-	

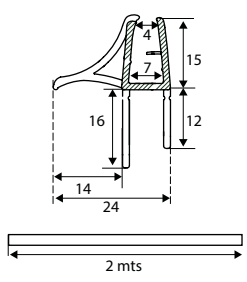

PVC

 TRANSPARENTE

PERFIL MAMPARA VIERTEAGUA PF6



18529

Código	8431488	Cristal - Medida	Acabado				€uros
18529	185293	6/8 mm - 19,5 mm	TR	-	8	-	
18530	185309	6/8 mm - 11,5 mm	TR	-	8	-	
18534	185347	8/10 mm - 11,5 mm	TR	-	8	-	

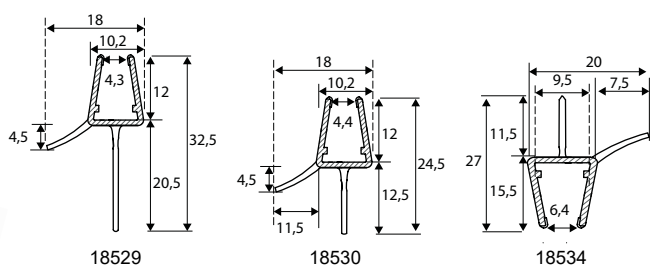

PVC

 TRANSPARENTE

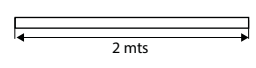

18530-18534

PERFIL MAMPARA JUNTA CRUCE PF5

Código	8431488	Cristal	Acabado				€uros
18528	185286	6/8 mm	TR	-	8	-	

PVC

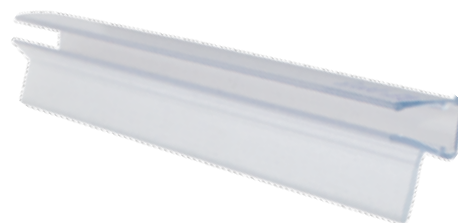
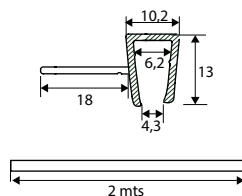

PERFIL MAMPARA VIERTEGUA CENTRAL PF7

Código	8431488	Cristal	Acabado				€uros
18531	185316	6/8 mm	TR	-	8	-	

PVC

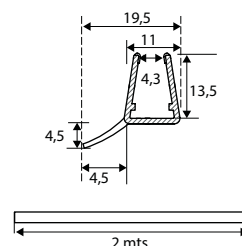

PERFIL MAMPARA JUNTA PF8

Código	8431488	Cristal - Medida	Acabado				€uros
18532	185323	6/8 mm - 23 mm	TR	-	8	-	
18533	185330	6/8 mm - 13 mm	TR	-	8	-	
18535	185354	8/10 mm - 23 mm	TR	-	8	-	

PVC

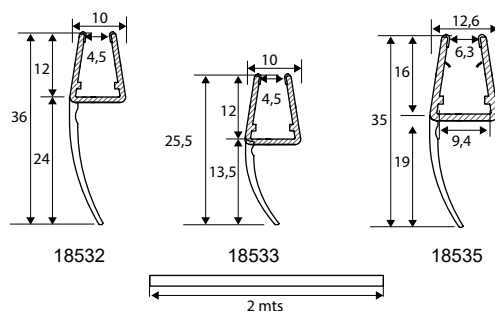

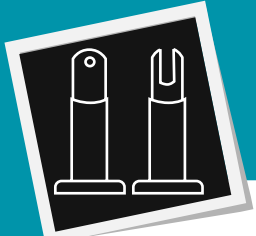

PERFIL MAMPARA MAGNÉTICO 45° N-S PF2

Código	8431488	Cristal	Acabado				€uros
18523	185231	6/8 mm	TR	-	8	-	
18536	185361	8/10 mm	TR	-	8	-	

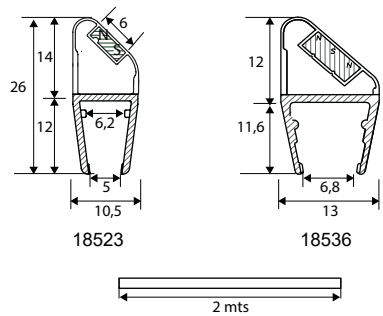
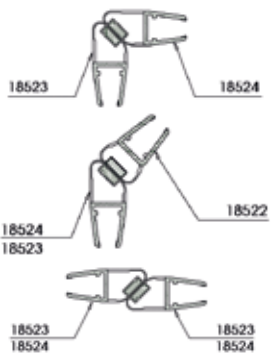

PVC



PERFIL MAMPARA MAGNÉTICO 45° S-N PF2

Código	8431488	Cristal	Acabado				€uros
18524	185248	6/8 mm	TR	-	8	-	
18537	185378	8/10 mm	TR	-	8	-	

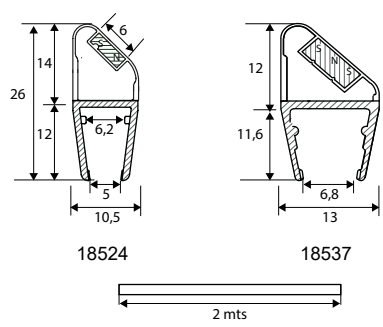
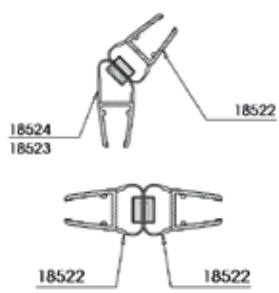

PVC



PERFIL MAMPARA MAGNÉTICO 180° PF1

Código	8431488	Cristal	Acabado				€uros
18522	185224	6/8 mm	TR	-	8	-	

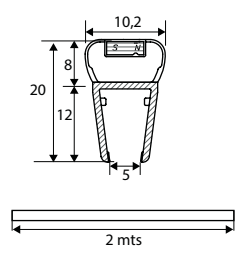

PVC



Te sugiero:

RODAMIENTOS MAMPARA
Pág. 87-88-89

