

PICAPORTE CONDENA PCT1

	Código	8431488	Medida	Acabado			€uros
Caja	10100	101002	47 mm	LTD	-	10	100
	10101	101019	47 mm	NS	-	10	100
	10102	101026	47 mm	NE	-	10	100
	10103	101033	47 mm	CU	-	10	100
Blister	90842	908427	47 mm	LTD	1	-	10
	90843	908434	47 mm	NS	1	-	10
	91564	915647	47 mm	NE	1	-	10
	91565	915654	47 mm	CU	1	-	10

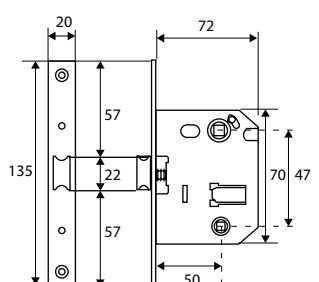

Canto redondo



Acero

LATONADO
 NIQUEL SATINADO
 NEGRO
 CUERO

PICAPORTE CONDENA PCT2

	Código	8431488	Medida	Acabado			€uros
Caja	10170	101705	70 mm	LTD	-	10	100
	10171	101712	70 mm	NS	-	10	100
	10172	101729	70 mm	NE	-	10	100
Blister	91186	911861	70 mm	LTD	1	-	10
	91187	911878	70 mm	NS	1	-	10
	91566	915661	70 mm	NE	1	-	10



Canto redondo

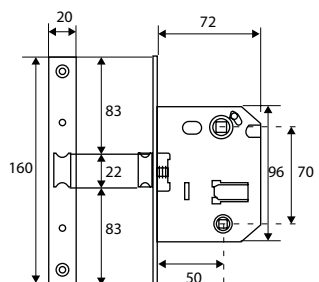

Acero

LATONADO
 NIQUEL SATINADO
 NEGRO

PICAPORTE TUBULAR PCT3

	Código	8431488	Canto/Medida A	Acabado			€uros
Caja	10111	101118	cuadrado/35 mm	LTD	-	20	200
	10112	101125	cuadrado/35 mm	NS	-	20	200
	10114	101149	redondo/45 mm	LTD	-	20	200
	10115	101156	redondo/45 mm	NS	-	20	200
	10116	101163	cuadrado/45 mm	LTD	-	20	200
	10117	101170	cuadrado/45 mm	NS	-	20	200
	10119	101194	cuadrado/60 mm	LTD	-	20	200
	10120	101200	cuadrado/60 mm	NS	-	20	200
	10121	111216	cuadrado/70 mm	LTD	-	20	200
	10122	111223	cuadrado/70 mm	NS	-	20	200
Blister	90119	901190	cuadrado/35 mm	LTD	1	-	10
	90120	901206	cuadrado/35 mm	NS	1	-	10
	90123	901237	redondo/45 mm	LTD	1	-	10
	90124	901244	redondo/45 mm	NS	1	-	10
	90121	901213	cuadrado/45 mm	LTD	1	-	10
	90122	901220	cuadrado/45 mm	NS	1	-	10
	91578	915784	cuadrado/60 mm	LTD	1	-	10
	91579	915791	cuadrado/60 mm	NS	1	-	10
	91668	916682	cuadrado/70 mm	LTD	1	-	10
91669	916699	cuadrado/70 mm	NS	1	-	10	



Acero

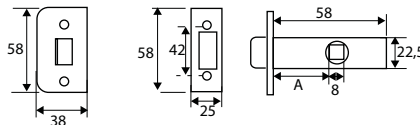

CONDENA PICAPORTE TUBULAR PCT4

	Código	8431488	Medida	Acabado			€uros
Caja	10145	101453	45 mm	LTD	-	20	200
	10146	101460	45 mm	NS	-	20	200
Blister	91670	916705	45 mm	LTD	1	-	10
	91671	916712	45 mm	NS	1	-	10

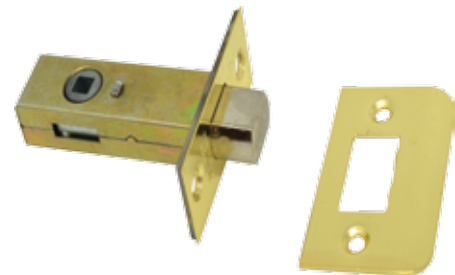

Acero

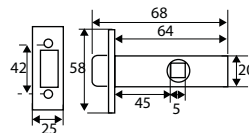

CERRADERO PICAPORTE PCT1/PCT3

	Código	8431488	Modelo	Acabado			€uros
Caja	10106	101064	condena PCT1	LTD	-	50	500
	10107	101071	condena PCT1	NS	-	50	500
	10108	101088	tubular PCT3	LTD	-	50	500
	10109	101095	tubular PCT3	NS	-	50	500
Blister	91672	916729	condena PCT1	LTD	1	-	10
	91673	916736	condena PCT1	NS	1	-	10
	91674	916743	tubular PCT3	LTD	1	-	10
	91675	916750	tubular PCT3	NS	1	-	10

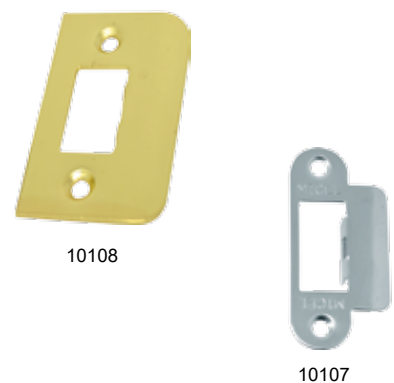

Acero

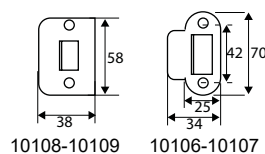

10108-10109 10106-10107

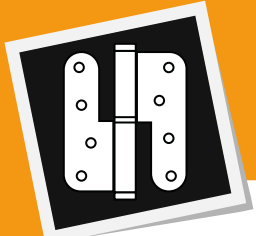

PICAPORTE RODILLO PCT5



	Código	8431488	Medida AxB	Acabado				€uros
Caja	10125	101255	80x18 mm	BC	-	12	60	
	10126	101262	100x21 mm	BC	-	12	60	
	10127	101279	120x23 mm	BC	-	12	60	
Blister	91676	916767	80x18 mm	BC	1	-	10	
	91677	916774	100x21 mm	BC	1	-	10	
	91678	916781	120x23 mm	BC	1	-	10	

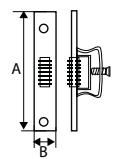

Acero



PICAPORTE VAIVÉN PCT6



	Código	8431488	Medida AxB	Acabado				€uros
Caja	10128	101286	60x15 mm	BC	-	12	120	
	10129	101293	80x18 mm	BC	-	12	120	
	10142	101422	100x21 mm	BC	-	12	120	
Blister	91679	916798	60x15 mm	BC	1	-	10	
	91680	916804	80x18 mm	BC	1	-	10	
	91681	916811	100x21 mm	BC	1	-	10	

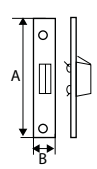

Acero



KIT PUERTA CORREDERA PCR3



	Código	8431488	Puerta	Acabado				€uros
Caja	48001	480015	35 mm	LTD	-	1	20	
	48002	480022	35 mm	NS	-	1	20	
	48003	480039	35 mm	CU	-	1	20	
	48008	480084	35 mm	NE	-	1	20	

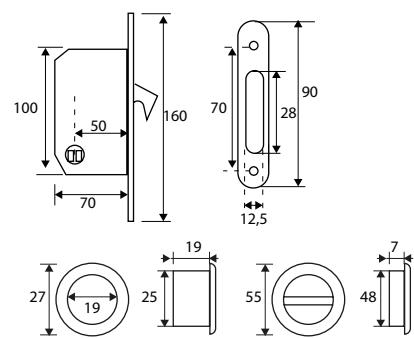

Acero



KIT PUERTA CORREDERA CUADRADO PCR4

	Código	8431488	Puerta	Acabado				€uros
Caja	48501	485010	35 mm	LTD	-	1	20	
	48502	485027	35 mm	NS	-	1	20	

Acero

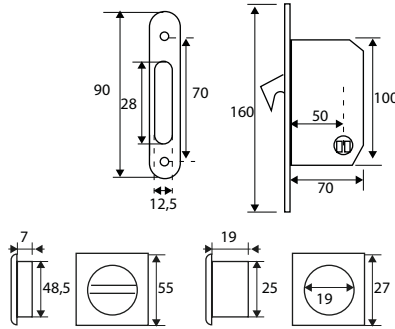

KIT PUERTA CORREDERA BOCALLAVE PCR5

	Código	8431488	Puerta	Acabado				€uros
Caja	48401	484013	35 mm	LTD	-	1	20	
	48402	484020	35 mm	NS	-	1	20	
	48403	484037	35 mm	CU	-	1	20	

Acero

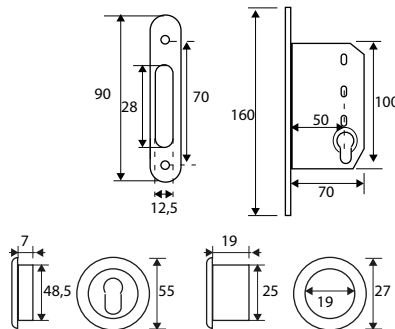

Cilindro 23x23 disponible en página 108



Te sugiero:



TIRADORES - Pág. 208-209

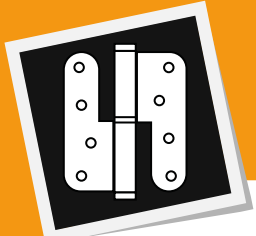

CERRADURA PICOLORO CRR3



Incluye cilindro

	Código	8431488	Medida A	Acabado				€uros
Caja	68120	681207	30 mm	ZN	-	1	10	
	68119	681191	40 mm	ZN	-	1	10	
	68118	681184	60 mm	ZN	-	1	10	

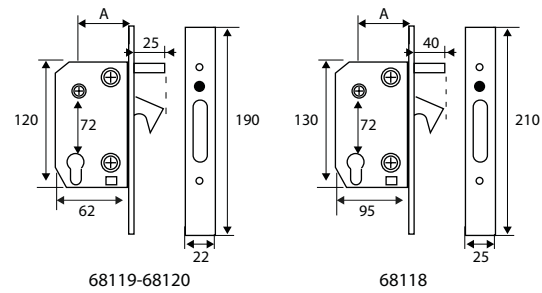

Acero

ZINCADO

CERRADERO P/CERRADURA PICOLORO CRR3



	Código	8431488	Medida	Acabado				€uros
	68121	681214	160x25 mm	ZN	-	1	5	

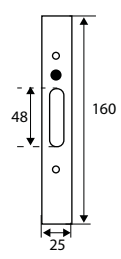

Acero

ZINCADO

CAJA CERRADURA PICOLORO CRR3



	Código	8431488	Medida A - B	Acabado				€uros
Caja	68103	681030	40 - 20	ZN	-	1	10	
	68104	681047	50 - 10	ZN	-	1	10	

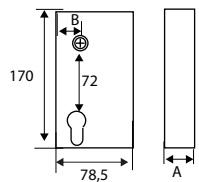

Acero

ZINCADO

CIERRAPUERTAS S/RETENEDOR MC1-S

	Código	8431488	Fuerza	Acabado				€uros
Caja	57208	572086	2-3	PL	-	1	10	
	57209	572093	2-3	BL	-	1	10	
	57210	572109	2-3	NE	-	1	10	
	57211	572116	2-3	OR	-	1	10	
Blister	57216	572161	2-3	PL	1	-	10	
	57217	572178	2-3	BL	1	-	8	
	57218	572185	2-3	NE	1	-	8	

Aluminio



PLATA BLANCO NEGRO ORO

Fuerza 2: 40 kgs
Fuerza 3: 70 kgs

Máximo peso de la puerta 70 kgs
Para puerta de 700-900 mm
Vale para puerta doble y sencilla

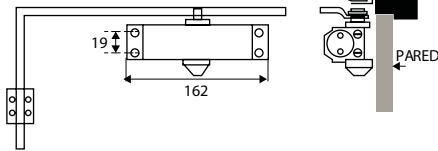

CIERRAPUERTAS C/RETENEDOR MC1-C

	Código	8431488	Fuerza	Acabado				€uros
Caja	57212	572123	2-3	PL	-	1	10	
	57213	572130	2-3	BL	-	1	10	
	57214	572147	2-3	NE	-	1	10	
	57215	572154	2-3	OR	-	1	10	
Blister	57219	572192	2-3	PL	1	-	8	

Aluminio



PLATA BLANCO NEGRO ORO

Fuerza 2: 40 kgs
Fuerza 3: 70 kgs

Máximo peso de la puerta 70 kgs
Para puerta de 700-900 mm
Vale para puerta doble y sencilla

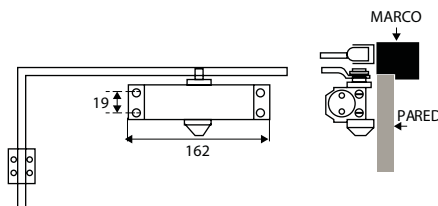

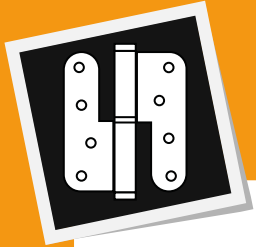

MUELLE CIERRAPUERTAS BRAZO MC2



	Código	8431488	Medida AxB	Acabado				€uros
Blister	57201	572017	200x30 mm	BL	1	-	10	
	57202	572024	200x30 mm	NE	1	-	10	
	57203	572031	200x30 mm	OR	1	-	10	
	57204	572048	200x30 mm	PL	1	-	10	

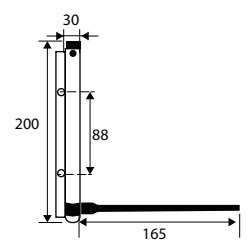

Aluminio

BLANCO
 NEGRO
 ORO
 PLATA

MUELLE CIERRAPUERTAS MC3

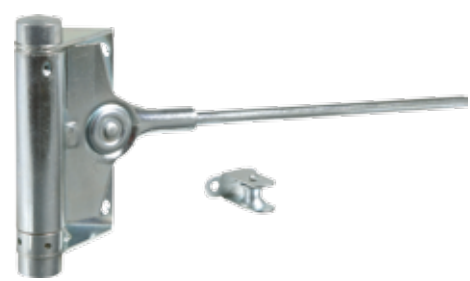

	Código	8431488	Medida AxB	Acabado				€uros
Caja	57205	572055	Nº1: 95x240 mm	ZN	-	4	20	
	57206	572062	Nº2: 120x240 mm	ZN	-	4	20	

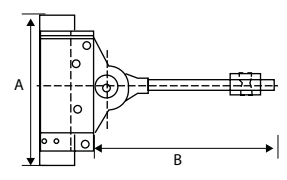

Acero

ZINCADO

CAPACIDAD DE CARGA
 57205.....Máx.. 25 Kilos
 57206.....Máx.. 40 Kilos

MUELLE CIERRAPUERTAS ESPIRAL MC4



	Código	8431488	Medida	Acabado				€uros
Caja	57207	572079	200 mm	NI	-	5	25	

Puerta máximo 40 kgs

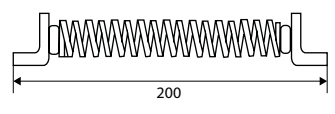

Acero

NIQUEL

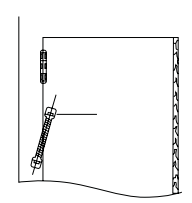

BISAGRA DOBLE ACCIÓN BS10

	Código	8431488	Medida AxBxC	Acabado				€uros
Blister	57001	570013	180x133x4 mm	BL	1	-	10	
	57002	570020	180x133x4 mm	NE	1	-	10	
	57003	570037	180x133x4 mm	OR	1	-	10	
	57004	570044	180x133x4 mm	PL	1	-	10	
	57005	570051	180x133x4 mm	BR	1	-	10	

Aluminio

C= espesor



Peso de 2 bisagras hasta 50 kilos
Peso de 3 bisagras hasta 95 kilos

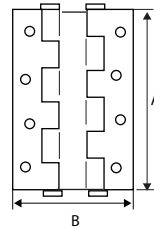

BISAGRA DOBLE ACCIÓN BS12

	Código	8431488	Medida Ax B	Acabado				€uros
Caja	57006	570068	75x29 mm	LTD	-	2	20	
	57007	570075	100x30 mm	LTD	-	2	10	
	57008	570082	125x33 mm	LTD	-	2	10	

Acero



57006..... 15 Kgs - para puerta de 600 mm (ancho 18-25 mm)
57007..... 22 Kgs - para puerta de 700 mm (ancho 25-30 mm)
57008..... 27 Kgs - para puerta de 700 mm (ancho 30-35 mm)

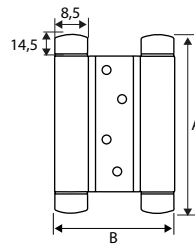

BISAGRA SIMPLE ACCIÓN BS11

	Código	8431488	Medida Ax BxC	Acabado				€uros
Blister	57101	571010	180x133x4 mm	BL	1	-	10	
	57102	571027	180x133x4 mm	NE	1	-	10	
	57103	571034	180x133x4 mm	OR	1	-	10	
	57104	571041	180x133x4 mm	PL	1	-	10	

Aluminio

C= espesor



Peso de 2 bisagras hasta 50 kilos
Peso de 3 bisagras hasta 95 kilos

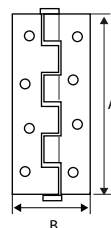

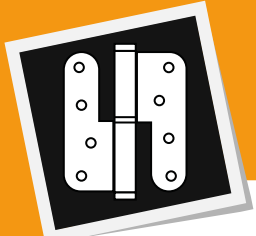

BISAGRA SEGURIDAD C/REMATE BS15

Código	8431488	Canto	Acabado				€uros
58180	581804	redondo	LTD	-	1	20	
59180	591803	cuadrado	LTD	-	1	20	
58184	581842	redondo	NS	-	1	20	
59184	591841	cuadrado	NS	-	1	20	
58181	581811	redondo	CU	-	1	20	
59181	591810	cuadrado	CU	-	1	20	
58183	581835	redondo	NE	-	1	20	
59183	591834	cuadrado	NE	-	1	20	
58185	581859	redondo	PE	-	1	20	
59185	591858	cuadrado	PE	-	1	20	

Espesor 3 mm

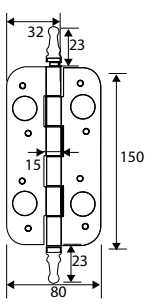

Acero

- LATONADO
- NÍQUEL SATINADO
- CUERO
- NEGRO
- PLATA ENVEJECIDA

BISAGRA SEGURIDAD S/REMATE BS16

Código	8431488	Canto	Acabado				€uros
58187	581873	redondo	NS	-	1	20	
59187	591872	cuadrado	NS	-	1	20	
58186	581866	redondo	INOX	-	1	20	
59186	591865	cuadrado	INOX	-	1	20	

Espesor 3 mm

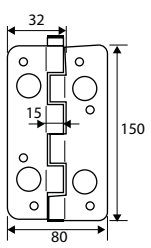

NS: Acero
INOX: Acero Inoxidable

- NÍQUEL SATINADO
- INOX



BISAGRA BS18 (PALA JUNTO NUDO)

Código	8431488	Medida AxB	Canto/Mano				€uros
11020	110202	90x65 mm	CR/dcha	-	10	100	
11021	110219	90x65 mm	CR/izda	-	10	100	
11022	110226	90x65 mm	CC/dcha	-	10	100	
11023	110233	90x65 mm	CC/izda	-	10	100	

Espesor 2,5 mm

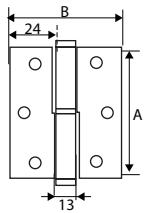

Acero Inoxidable

- INOX

CR: redondo
CC: cuadrado



BISAGRA BS17 (PALA SEPARADA NUDO)

	Código	8431488	Medida AxBxC	Canto/Mano			€uros
Caja	11024	110240	90x65x2,5 mm	CR/dcha	-	10	100
	11025	110257	90x65x2,5 mm	CR/izda	-	10	100
	11028	110288	100x86x3 mm	CR/dcha	-	2	60
	11029	110295	100x86x3 mm	CR/izda	-	2	60
	11030	110301	100x86x3 mm	CC/dcha	-	2	50
	11031	110318	100x86x3 mm	CC/izda	-	2	50

Acero Inoxidable



INOX

CR: redondo
CC: cuadrado

C: Espesor

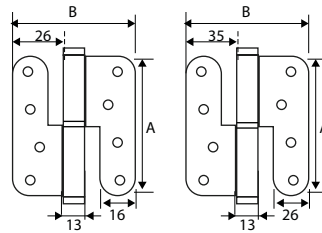

11024-11025

11028-11029
11030-11031



PERNIO S/REMATE PN7

	Código	8431488	Medida/Mano	Acabado			€uros
Caja	20703	207032	80x50 mm/dcha	INOX	-	20	240
	20704	207049	80x50 mm/izda	INOX	-	20	240
	20701	207018	100x58 mm/dcha	INOX	-	20	240
	20702	207025	100x58 mm/izda	INOX	-	20	240
Blister	92207	922072	80x50 mm/dcha	INOX	2	-	10
	92208	922089	80x50 mm/izda	INOX	2	-	10
	90948	909486	100x58 mm/dcha	INOX	2	-	10
	90949	909493	100x58 mm/izda	INOX	2	-	10

Acero Inoxidable



INOX

Incluye tornillos en el blister

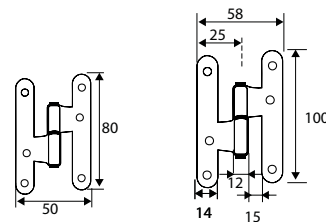

20703-20704

20701-20702

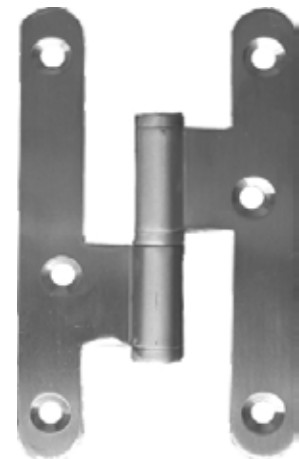

PERNIO S/REMATE PN9

	Código	8431488	Medida/Mano	Acabado			€uros
Caja	11015	110158	95x54 mm/dcha	LTD	-	20	240
	11016	110165	95x54 mm/izda	LTD	-	20	240
	11017	110172	95x54 mm/dcha	NS	-	20	240
	11018	110189	95x54 mm/izda	NS	-	20	240
Blister	92199	921990	95x54 mm/dcha	LTD	2	-	10
	92200	922003	95x54 mm/izda	LTD	2	-	10
	92201	922010	95x54 mm/dcha	NS	2	-	10
	92202	922027	95x54 mm/izda	NS	2	-	10

Acero



LATONADO



NIQUEL SATINADO

Incluye tornillos en el blister

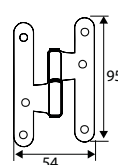

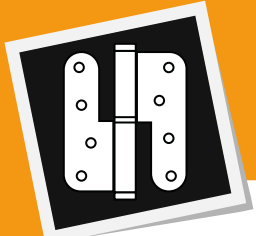

PERNIO C/REMATE PN3



	Código	843 I 488	Medida/Mano	Acabado				€uros
Caja	11040	110400	100x58 mm/dcha	LS	-	20	240	
	11041	110417	100x58 mm/izda	LS	-	20	240	
	11060	110608	100x58 mm/dcha	CU	-	20	240	
	11061	110615	100x58 mm/izda	CU	-	20	240	
	11070	110707	100x58 mm/dcha	NE	-	20	240	
	11071	110714	100x58 mm/izda	NE	-	20	240	
Blister	90924	909240	100x58 mm/dcha	LS	2	-	10	
	90925	909257	100x58 mm/izda	LS	2	-	10	
	90928	909288	100x58 mm/dcha	CU	2	-	10	
	90929	909295	100x58 mm/izda	CU	2	-	10	
	90930	909301	100x58 mm/dcha	NE	2	-	10	
	90931	909318	100x58 mm/izda	NE	2	-	10	

Incluye tornillos en el blister

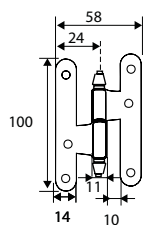

Acero

LATÓN SATINADO CUERO NEGRO

PERNIO S/REMATE PN4



	Código	843 I 488	Medida/Mano	Acabado				€uros
Caja	11080	110806	100x58 mm/dcha	LS	-	20	240	
	11081	110813	100x58 mm/izda	LS	-	20	240	
	11090	110905	100x58 mm/dcha	NS	-	20	240	
	11091	110912	100x58 mm/izda	NS	-	20	240	
Blister	90932	909325	100x58 mm/dcha	LS	2	-	10	
	90933	909332	100x58 mm/izda	LS	2	-	10	
	90934	909349	100x58 mm/dcha	NS	2	-	10	
	90935	909356	100x58 mm/izda	NS	2	-	10	

Incluye tornillos en el blister

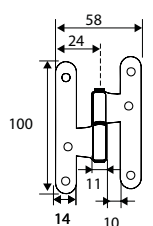

Acero

LATÓN SATINADO NÍQUEL SATINADO

PERNIO S/REMATE PN6



	Código	843 I 488	Medida/Mano	Acabado				€uros
Caja	85010	850108	100x57 mm/dcha	LTD	-	20	240	
	85011	850115	100x57 mm/izda	LTD	-	20	240	

Aluminio

LATONADO

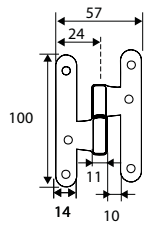

OVALILLO PERNIO OV1

	Código	8431488	Medida	Acabado				€uros
Caja	11012	110127	7x10,5x3 mm	LTD	-	100	2.500	
	11013	110134	7x10,5x3 mm	NE	-	100	2.500	
	11014	110141	7x10,5x3 mm	INOX	-	100	2.500	
Blister	90721	907215	7x10,5x3 mm	LTD	10	-	10	
	90722	907222	7x10,5x3 mm	NE	10	-	10	
	91885	918853	7x10,5x3 mm	INOX	10	-	10	

LTD: Acero; NE: Nylon; INOX: Acero Inoxidable

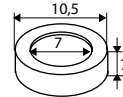

OVALILLO LATÓN OV2

	Código	8431488	Medida A-B-C	Acabado				€uros
Caja	68110	681108	10x7x1,5 mm	LT	-	50	1.250	
	68334	683348	10x7x2 mm	LT	-	50	1.250	
	68111	681115	12x8x1,5 mm	LT	-	50	1.250	
	68335	683355	12x8x2 mm	LT	-	50	1.250	
	68112	681122	14x9x2 mm	LT	-	50	1.250	
	68336	683362	14x9x3 mm	LT	-	50	1.250	
	68113	681139	16x11x2 mm	LT	-	50	1.250	
	68337	683379	16x11x3 mm	LT	-	50	1.250	
	68114	681146	18x11x2 mm	LT	-	50	1.250	
	68338	683386	18x11x3 mm	LT	-	50	1.250	
	68115	681153	20x12x2 mm	LT	-	50	1.250	
	68339	683393	20x12x3 mm	LT	-	50	1.250	
	68116	681160	22x14x2,5 mm	LT	-	50	1.250	
68117	681177	25x15x2,5 mm	LT	-	50	1.250		
Blister	91654	916545	10x7x1,5 mm	LT	6	-	10	
	92315	923154	10x7x2 mm	LT	6	-	10	
	91655	916552	12x8x1,5 mm	LT	6	-	10	
	92316	923161	12x8x2 mm	LT	6	-	10	
	91656	916569	14x9x2 mm	LT	6	-	10	
	92317	923178	14x9x3 mm	LT	6	-	10	
	91657	916576	16x11x2 mm	LT	6	-	10	
	92318	923185	16x11x3 mm	LT	6	-	10	
	91658	916583	18x11x2 mm	LT	6	-	10	
	92319	923192	18x11x3 mm	LT	6	-	10	
	91659	916590	20x12x2 mm	LT	4	-	10	
	92320	923208	20x12x3 mm	LT	4	-	10	
	91660	916606	22x14x2,5 mm	LT	4	-	10	
91661	916613	25x15x2,5 mm	LT	4	-	10		

Latón

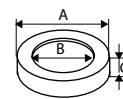

OVALILLO LATÓN SURTIDO OV2

	Código	8431488	Medida	Acabado				€uros
Blister	92321	923215	SURTIDO	LT	8	-	10	4,7500

Latón



Incluye:
 2 uds - 68110 (10x7x1,5 mm)
 2 uds - 68111 (12x8x1,5 mm)
 2 uds - 68112 (14x9x2 mm)
 2 uds - 68113 (16x11x2 mm)

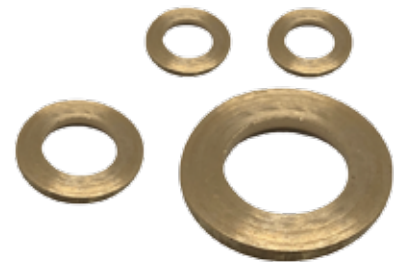

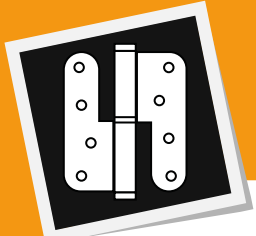

PERNIO TORNEADO 692

	Código	843 I488	Medida AxB	Acabado				€uros
Caja	68078	680781	10x58 mm	PU	-	60	-	
	68079	680798	12x70 mm	PU	-	45	-	
	68080	680804	14x80 mm	PU	-	28	-	
	68081	680811	16x100 mm	PU	-	35	-	
	68082	680828	20x120 mm	PU	-	20	-	
Blister	91302	913025	10x58 mm	PU	3	-	10	
	91303	913032	12x70 mm	PU	3	-	10	
	91304	913049	14x80 mm	PU	2	-	10	
	91305	913056	16x100 mm	PU	2	-	10	

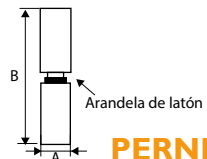

Acero

HIERRO PULIDO

PERNIO TORNEADO 693

	Código	843 I488	Medida AxB	Acabado				€uros
Caja	68083	680835	10x60 mm	INOX	-	20	-	
	68084	680842	12x70 mm	INOX	-	20	-	
	68085	680859	14x80 mm	INOX	-	14	-	
	68086	680866	16x100 mm	INOX	-	15	-	

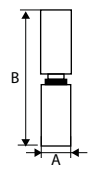

Acero Inoxidable

INOX

PERNIO RODAMIENTO AXIAL 694

	Código	843 I488	Medida AxB	Acabado				€uros
Caja	68087	680873	16x100 mm	PU	-	35	-	
	68088	680880	20x120 mm	PU	-	20	-	
	68089	680897	22x120 mm	PU	-	16	-	
Blister	91310	913100	16x100 mm	PU	2	-	10	

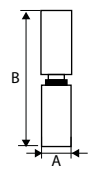

Acero

HIERRO PULIDO

PERNIO PERFIL GOTA 695

	Código	843 I488	Medida AxB	Acabado				€uros
Caja	68090	680903	10x60 mm	PU	-	60	-	
	68091	680910	14x80 mm	PU	-	28	-	
	68092	680927	16x100 mm	PU	-	35	-	
	68093	680934	16x120 mm	PU	-	30	-	
Blister	91311	913117	10x60 mm	PU	3	-	10	
	91312	913124	14x80 mm	PU	2	-	10	
	91313	913131	16x100 mm	PU	2	-	10	

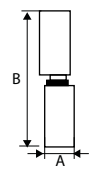

Acero

HIERRO PULIDO

PERNIO PALA 696

	Código	8431488	Medida AxBxCxD	Acabado				€uros
Caja	68094	680941	10x60x2x17 mm	PU	-	40	-	
	68095	680958	14x80x3x29 mm	PU	-	20	-	
	68096	680965	16x100x3x30 mm	PU	-	24	-	
	68097	680972	18x110x4x30 mm	PU	-	16	-	
Blister	91314	913148	10x60x2x17 mm	PU	3	-	10	
	91315	913155	14x80x3x29 mm	PU	3	-	10	
	91316	913162	16x100x3x30 mm	PU	3	-	10	

Acero



HIERRO PULIDO

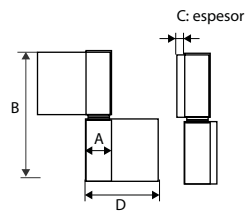

PERNIO PALA LARGA 699

	Código	8431488	Medida AxBxCxD	Acabado				€uros
Caja	68072	680729	14x80x3x38 mm	PU	-	20	-	
	68074	680743	16x100x3x39 mm	PU	-	20	-	
Blister	91317	913179	14x80x3x38 mm	PU	3	-	10	
	91318	913186	16x100x3x39 mm	PU	3	-	10	

Acero



HIERRO PULIDO

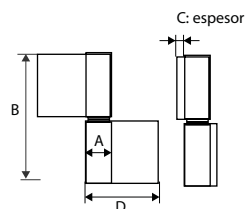

BISAGRA LIBRO 697

	Código	8431488	Medida AxBxCxD	Acabado				€uros
Caja	68098	680989	80x50x3x18,5 mm	PU	-	20	-	
	68099	680996	100x64x4x19 mm	PU	-	12	-	
	68075	680750	150x60x4x18 mm	PU	-	10	-	

Acero



HIERRO PULIDO

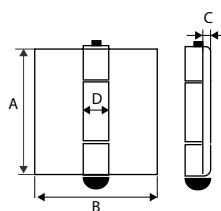

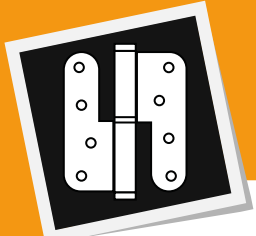

JGO BISAGRA PIVOTANTE BS9

	Código	8431488	Canto	Acabado				€uros
Caja	65003	650036	redondo	INOX	-	1	20	
	65004	650043	cuadrado	INOX	-	1	20	

Peso máximo 100 Kgs

Acero Inoxidable

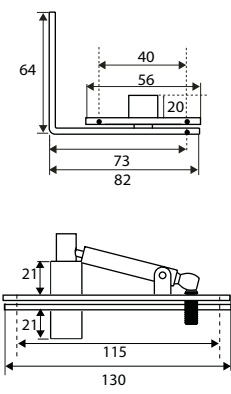

JGO BISAGRA PIVOTANTE BS13

	Código	8431488	Medida	Acabado				€uros
Caja	65001	650012	80x10 mm	LTD	-	24	120	

Acero

1 juego contiene:
4 machos y 4 hembras

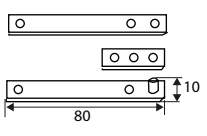

JGO BISAGRA PIVOTANTE BS14

	Código	8431488	Medida	Acabado				€uros
Caja	65002	650029	60x10 mm	LTD	-	24	120	

Acero

1 juego contiene:
2 machos izquierda, 2 machos derecha,
2 hembras izquierda y 2 hembras derecha

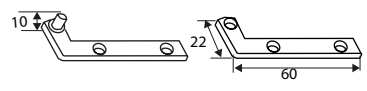

BISAGRA OCULTA BS3

	Código	8431488	Medida	Acabado			€uros
Caja	67353	673530	89x25 mm	INOX	-	20	60

Acero Inoxidable

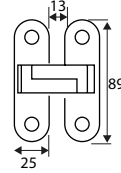

BISAGRA OCULTA BS4

	Código	8431488	Medida Ax B	Acabado			€uros
Caja	67354	673547	60x12,7 mm	INOX	-	2	50
	67355	673554	70x15,8 mm	INOX	-	2	50
	67356	673561	95x19,5 mm	INOX	-	2	20

Acero Inoxidable

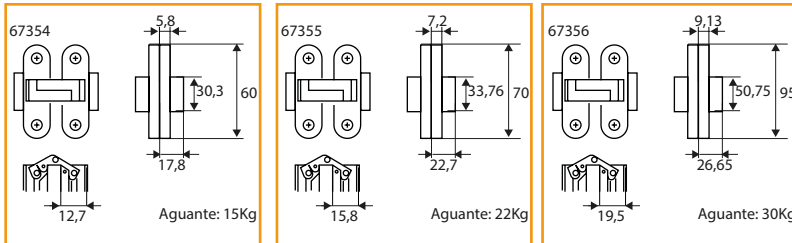

BISAGRA OCULTA BS2

	Código	8431488	Medida Ax B	Acabado			€uros
Caja	67350	673509	65x13 mm	LTD	-	20	200
	67351	673516	65x13 mm	NI	-	20	200
	67352	673523	65x13 mm	BR	-	20	200
Blister	91682	916828	65x13 mm	LTD	2	-	10
	91683	916835	65x13 mm	NI	2	-	10
	91684	916842	65x13 mm	BR	2	-	10

Acero

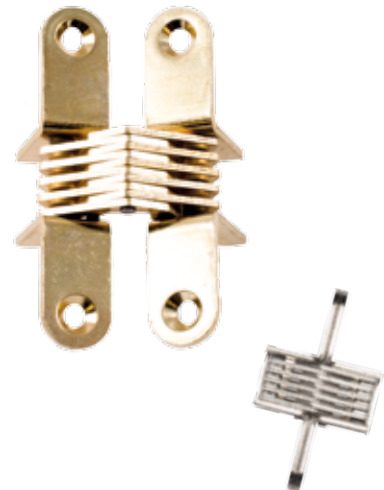
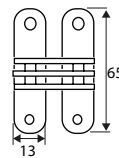

BISAGRA OCULTA BS1

	Código	8431488	Medida Ax B	Acabado			€uros
Caja	65010	650104	10x22 mm	LS	-	10	250
	65012	650128	12x28 mm	LS	-	10	250
	65014	650142	14x31 mm	LS	-	10	250
Blister	91368	913681	10x22 mm	LS	2	-	10
	91369	913698	12x28 mm	LS	2	-	10
	91370	913704	14x31 mm	LS	2	-	10

Latón



65010- C:11
65012- C:14
65014- C:15,5

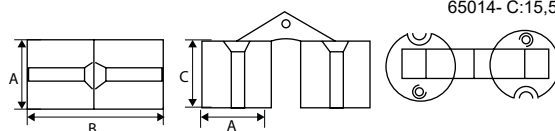

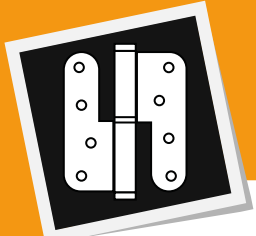

BISAGRA MUEBLE BS5

	Código	8431488	Medida	Acabado				€uros
Caja	67358	673585	26 mm	NI	-	2	50	

Regulación en profundidad 0-2 mm. Ajuste lateral 0 -1 mm
Ajustes vertical 0+2 mm puerta abierta y 2 mm puerta cerrada

Zamak

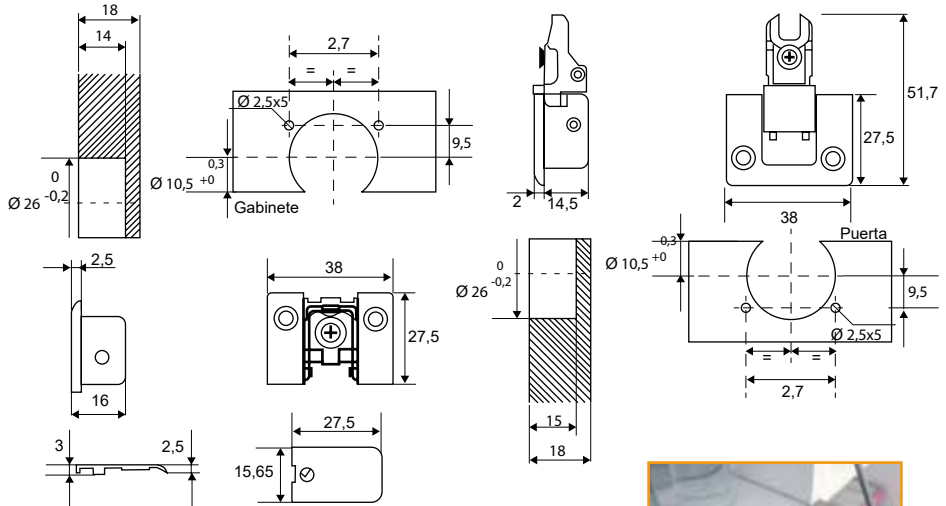

NIQUEL



SUPLEMENTO BISAGRA BS5

	Código	8431488	Medida	Acabado				€uros
Caja	67359	673592	2 mm	NI	-	1	10	
	67360	673608	4 mm	NI	-	1	10	

Zamak

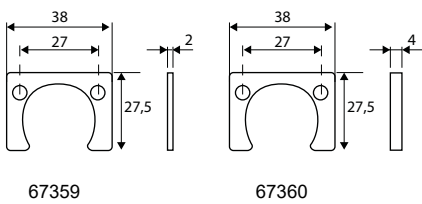

NIQUEL

BISAGRA MOSTRADOR BS19

	Código	8431488	Medida	Acabado				€uros
Caja	67334	673349	80x32x1,5 mm	LTD	-	24	600	
	67335	673356	80x32x1,5 mm	ZN	-	24	600	
Blister	91366	913667	80x32x1,5 mm	LTD	2	-	10	
	91367	913674	80x32x1,5 mm	ZN	2	-	10	

Incluye tornillos en el blister

Acero

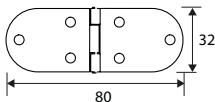

LATONADO ZINCADO

JGO BISAGRA CRISTAL BSC21

	Código	8431488	Medida	Acabado			€uros
Caja	32506	325064	40x18 mm	LTD	-	5	125
	32507	325071	40x18 mm	CB	-	5	125
	32508	325088	40x18 mm	NE	-	5	125
	32509	325095	40x18 mm	NS	-	5	125
Blister	92266	922669	40x18 mm	LTD	1	-	10
	92267	922676	40x18 mm	CB	1	-	10
	92268	922683	40x18 mm	NE	1	-	10
	92269	922690	40x18 mm	NS	1	-	10

Zamak

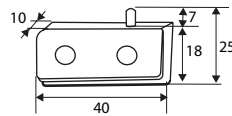

JGO BISAGRA CRISTAL BSC22

	Código	8431488	Medida	Acabado			€uros
	32510	325101	83x30 mm	NI	-	1	5
Blister	92300	923000	83x30 mm	NI	1	-	10

Zamak

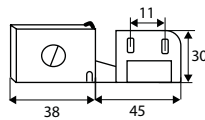

JGO BISAGRA CRISTAL BSC23

	Código	8431488	Medida	Acabado			€uros
	32520	325200	50x25 mm	CB	-	10	50
Blister	92325	923253	50x25 mm	CB	1	-	10

Zamak



Código de barras individual

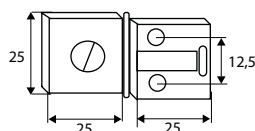

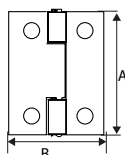
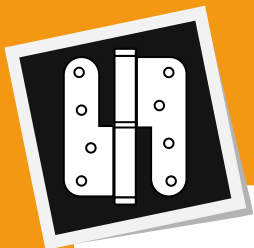

BISAGRA 5005 BS27

	Código	8431488	Medida AxB	Acabado				€uros
Caja	67252	672526	3/4" 19x15 mm	PU	-	24	600	
	67253	672533	1" 25x20 mm	PU	-	24	600	
	67254	672540	1"1/4 31x22 mm	PU	-	24	600	
	67255	672557	1"1/2 37x26 mm	PU	-	24	600	
	67256	672564	1"3/4 43x28 mm	PU	-	24	600	
	67257	672571	2" 50x30 mm	PU	-	24	600	
	67258	672588	2"1/4 56x31 mm	PU	-	24	600	
	67259	672595	2"1/2 63x32 mm	PU	-	24	600	
	67260	672601	2"3/4 69x36 mm	PU	-	24	240	
	67261	672618	3" 75x42 mm	PU	-	24	240	
	67262	672625	3"1/2 87x49 mm	PU	-	24	240	
	67263	672632	4" 100x53 mm	PU	-	24	120	
	67264	672649	3/4" 19x15 mm	ZN	-	24	600	
	67265	672656	1" 25x20 mm	ZN	-	24	600	
	67266	672663	1"1/4 31x22 mm	ZN	-	24	600	
	67267	672670	1"1/2 37x26 mm	ZN	-	24	600	
	67268	672687	1"3/4 43x28 mm	ZN	-	24	600	
	67269	672694	2" 50x30 mm	ZN	-	24	600	
	67270	672700	2"1/4 56x31 mm	ZN	-	24	600	
	67271	672717	2"1/2 63x32 mm	ZN	-	24	600	
	67272	672724	2"3/4 69x36 mm	ZN	-	24	240	
	67273	672731	3" 75x42 mm	ZN	-	24	240	
	67274	672748	3"1/2 87x49 mm	ZN	-	24	240	
	67275	672755	4" 100x53 mm	ZN	-	24	120	
	67336	673363	3/4" 19x15 mm	LTD	-	24	600	
	67337	673370	1" 25x20 mm	LTD	-	24	600	
	67338	673387	1"1/4 31x22 mm	LTD	-	24	600	
	67339	673394	1"1/2 37x26 mm	LTD	-	24	600	
	67340	673400	1"3/4 43x28 mm	LTD	-	24	600	
	67341	673417	2" 50x30 mm	LTD	-	24	600	
	67342	673424	2"1/4 56x31 mm	LTD	-	24	600	
	67343	673431	2"1/2 63x32 mm	LTD	-	24	600	
	67344	673448	2"3/4 69x36 mm	LTD	-	24	240	
	67345	673455	3" 75x42 mm	LTD	-	24	240	
	67346	673462	3"1/2 87x49 mm	LTD	-	24	240	
	67347	673479	4" 100x53 mm	LTD	-	24	120	
	Blister	91340	913407	1" 25x20 mm	ZN	4	-	10
91341		913414	1"1/2 37x26 mm	ZN	4	-	10	
91342		913421	2" 50x30 mm	ZN	2	-	10	
91343		913438	2"1/2 63x32 mm	ZN	2	-	10	
91344		913445	3" 75x42 mm	ZN	2	-	10	
91381		913810	1" 25x20 mm	LTD	4	-	10	
91382		913827	1"1/2 37x26 mm	LTD	4	-	10	
91383		913834	2" 50x30 mm	LTD	2	-	10	
91384		913841	2"1/2 63x32 mm	LTD	2	-	10	
91385		913858	3" 75x42 mm	LTD	2	-	10	

Incluye tornillos en el blister

Acero



HIERRO
PULIDO





ZINCADO



LATONADO

BISAGRA RAMAL BS28

	Código	8431488	Medida AxB	Acabado				€uros
Caja	67276	672762	2" 22x50 mm	PU	-	24	600	
	67277	672779	2"1/2 22x63 mm	PU	-	24	600	
	67278	672786	3" 25x75 mm	PU	-	24	600	
	67279	672793	4" 25x100 mm	PU	-	24	600	
	67280	672809	5" 27x125 mm	PU	-	24	240	
	67281	672816	6" 27x150 mm	PU	-	24	240	
	67282	672823	2" 22x50 mm	ZN	-	24	600	
	67283	672830	2"1/2 22x63 mm	ZN	-	24	600	
	67284	672847	3" 25x75 mm	ZN	-	24	600	
	67285	672854	4" 25x100 mm	ZN	-	24	600	
	67286	672861	5" 27x125 mm	ZN	-	24	240	
67287	672878	6" 27x150 mm	ZN	-	24	240		
Blister	91345	913452	2" 22x50 mm	ZN	4	-	10	
	91346	913469	2"1/2 22x63 mm	ZN	2	-	10	
	91347	913476	3" 25x75 mm	ZN	2	-	10	
	91348	913483	4" 25x100 mm	ZN	2	-	10	





Acero

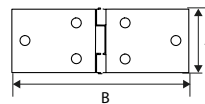

 Incluye tornillos en el blister



BISAGRA 814 BS29

	Código	8431488	Medida AxB	Acabado				€uros
Caja	67288	672885	3/4" 22x64 mm	PU	-	24	600	
	67289	672892	1" 25x76 mm	PU	-	24	600	
	67290	672908	1"1/4 31x84 mm	PU	-	24	600	
	67291	672915	1"1/2 37x90 mm	PU	-	24	240	
	67292	672922	1"3/4 43x102 mm	PU	-	24	240	
	67293	672939	2" 50x112 mm	PU	-	24	240	
	67294	672946	2"1/4 56x130 mm	PU	-	12	120	
	67295	672953	2"1/2 63x150 mm	PU	-	12	60	
	67296	672960	3" 75x175 mm	PU	-	12	60	
	67297	672977	3/4" 22x64 mm	ZN	-	24	600	
	67298	672984	1" 25x76 mm	ZN	-	24	600	
	67299	672991	1"1/4 31x84 mm	ZN	-	24	600	
	67300	673004	1"1/2 37x90 mm	ZN	-	24	240	
	67301	673011	1"3/4 43x102 mm	ZN	-	24	240	
	67302	673028	2" 50x112 mm	ZN	-	24	240	
	67303	673035	2"1/4 56x130 mm	ZN	-	12	120	
	67304	673042	2"1/2 63x150 mm	ZN	-	12	60	
	67305	673059	3" 75x175 mm	ZN	-	12	60	
	Blister	91349	913490	3/4" 22x64 mm	ZN	4	-	10
91350		913506	1" 25x76 mm	ZN	4	-	10	
91351		913513	1"1/4 31x84 mm	ZN	2	-	10	
91352		913520	1"1/2 37x90 mm	ZN	2	-	10	
91353		913537	1"3/4 43x102 mm	ZN	2	-	10	



Acero



 Incluye tornillos en el blister

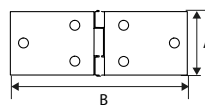

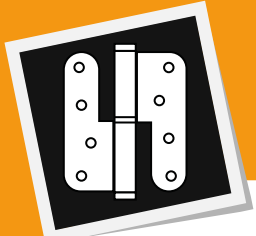

BISAGRA 816 BS30



	Código	843 I 488	Medida AxB	Acabado				€uros
Caja	67306	673066	1" 22x50 mm	PU	-	24	600	
	67307	673073	1"1/4 31x57 mm	PU	-	24	600	
	67308	673080	1"1/2 37x70 mm	PU	-	24	240	
	67309	673097	1"3/4 43x78 mm	PU	-	24	240	
	67310	673103	2" 50x95 mm	PU	-	24	240	
	67311	673110	2"1/4 56x103 mm	PU	-	12	120	
	67312	673127	2"1/2 63x120 mm	PU	-	12	120	
	67313	673134	1" 22x50 mm	ZN	-	24	600	
	67314	673141	1"1/4 31x57 mm	ZN	-	24	600	
	67315	673158	1"1/2 37x70 mm	ZN	-	24	240	
	67316	673165	1"3/4 43x78 mm	ZN	-	24	240	
	67317	673172	2" 50x95 mm	ZN	-	24	240	
Blister	91354	913544	1" 22x50 mm	ZN	4	-	10	
	91355	913551	1"1/4 31x57 mm	ZN	2	-	10	
	91356	913568	1"1/2 37x70 mm	ZN	2	-	10	
	91357	913575	1"3/4 43x78 mm	ZN	2	-	10	
	91358	913582	2" 50x95 mm	ZN	2	-	10	
	91359	913599	2"1/4 56x103 mm	ZN	2	-	10	

Incluye tornillos en el blister

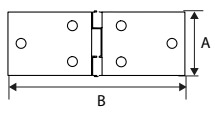

Acero
 HIERRO PULIDO
 ZINCADO

BISAGRA 840 BS31



	Código	843 I 488	Medida AxB	Acabado				€uros
Caja	67320	673202	3" 75x49 mm	PU	-	24	240	
	67321	673219	3"1/2 87x55 mm	PU	-	24	120	
	67322	673226	4" 100x70 mm	PU	-	24	120	
	67323	673233	4"1/2 112x75 mm	PU	-	12	60	
	67324	673240	5" 125x85 mm	PU	-	12	60	
	67325	673257	3" 75x49 mm	ZN	-	24	240	
	67326	673264	3"1/2 87x55 mm	ZN	-	24	120	
	67327	673271	4" 100x70 mm	ZN	-	24	120	
	67328	673288	4"1/2 112x75 mm	ZN	-	12	60	
	67329	673295	5" 125x85 mm	ZN	-	12	60	
Blister	91360	913605	3" 75x49 mm	ZN	2	-	10	
	91361	913612	3"1/2 87x55 mm	ZN	2	-	10	
	91362	913629	4" 100x70 mm	ZN	2	-	10	

Incluye tornillos en el blister

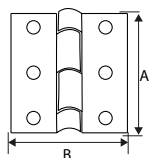

Acero
 HIERRO PULIDO
 ZINCADO

BISAGRA ESTUCHE BS22

	Código	8431488	Medida AxB	Acabado				€uros
Caja	30615	306155	13x15 mm	LP	-	200	5000	
	30620	306209	13x20 mm	LP	-	200	5000	
	30625	306254	13x25 mm	LP	-	200	5000	
Blister	90305	903057	13x15 mm	LP	6	-	10	
	90306	903064	13x20 mm	LP	6	-	10	
	90307	903071	13x25 mm	LP	4	-	10	

Acero

Incluye puntas en el blister

LATÓN PULIDO

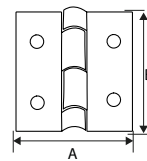

CIERRE ESTUCHE CC11

	Código	8431488	Medida	Acabado				€uros
Caja	30725	307251	25 mm	LP	-	50	1250	
Blister	90308	903088	25 mm	LP	2	-	10	

Acero

Incluye puntas en el blister

LATÓN PULIDO

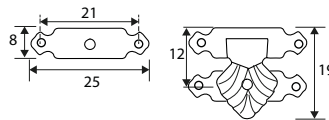

BISAGRA BS22 + CIERRE ESTUCHE CC11

	Código	8431488	Medida	Acabado				€uros
Blister	90309	903095	13x15 + 25 mm	LP	3 + 1	-	10	
	90310	903101	13x20 + 25 mm	LP	3 + 1	-	10	
	90311	903118	13x25 + 25 mm	LP	3 + 1	-	10	

Acero

Incluye puntas en el blister

LATÓN PULIDO



PUNTAS DE LATÓN PNT2

	Código	8431488	Medida AxB	Acabado				€uros
Caja	80026	800264	1,2x11 mm	LT	-	1000	-	
	80027	800271	1,5x13 mm	LT	-	1000	-	
	80028	800288	1,5x18 mm	LT	-	1000	-	
Blister	90312	903125	1,2x11 mm	LT	50	-	10	
	90313	903132	1,5x13 mm	LT	40	-	10	
	90314	903149	1,5x18 mm	LT	20	-	10	

Latón

LATÓN

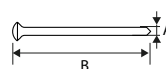

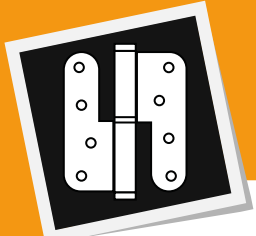

BISAGRA PIANO BS21 (TIRA)

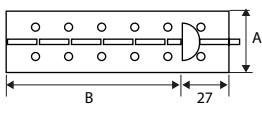

Código	8431488	Medida AxB	Acabado				€uros
33201	332017	32x480 mm	LTD	1	-	10	
33202	332024	32x720 mm	LTD	1	-	10	
33203	332031	32x960 mm	LTD	1	-	10	
33204	332048	32x480 mm	NI	1	-	10	
33205	332055	32x720 mm	NI	1	-	10	
33206	332062	32x960 mm	NI	1	-	10	

Incluye agujero colgador

Acero



BISAGRA PIANO BS32 (ROLLO)

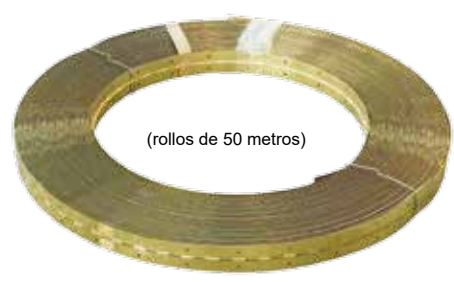

(rollos de 50 metros)

Código	8431488	Medida A	Acabado				€uros
33207	332079	20 mm	LTD	-	1	7	
33250	332505	32 mm	LTD	-	1	6	
34050	340500	40 mm	LTD	-	1	5	
33208	332086	20 mm	NI	-	1	7	
33251	332512	32 mm	NI	-	1	6	
34051	340517	40 mm	NI	-	1	5	
33252	332529	32 mm	INOX	-	1	6	
34052	340524	40 mm	INOX	-	1	5	

LTD-NI: Acero
INOX: Acero Inoxidable

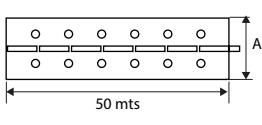
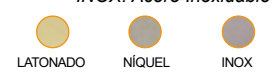

BISAGRA FORMA "T" BS23



código	A	B	C	D
19310/19410	109	75	38	11,5
19313/19413	138	88	38	11,5
19315/19415	155	88	38	11,5
19317/19417	188	88	38	11,5
19320/19420	207	111	45	12,5
19325/19425	262	111	45	12,5
19330/19430	312	111	45	12,5

Código	8431488	Medida	Acabado				€uros
19310	193106	100 mm	ZN	-	10	100	
19313	193137	130 mm	ZN	-	10	100	
19315	193151	150 mm	ZN	-	10	50	
19317	193175	175 mm	ZN	-	10	50	
19320	193205	200 mm	ZN	-	10	50	
19325	193250	250 mm	ZN	-	10	50	
19330	193304	300 mm	ZN	-	10	50	
19410	194103	100 mm	NE	-	10	100	
19413	194134	130 mm	NE	-	10	100	
19415	194158	150 mm	NE	-	10	50	
19417	194172	175 mm	NE	-	10	50	
19420	194202	200 mm	NE	-	10	50	
19425	194257	250 mm	NE	-	10	50	
19430	194301	300 mm	NE	-	10	50	
92418	924182	100 mm	ZN	1	-	10	
92419	924199	130 mm	ZN	1	-	10	
92420	924205	150 mm	ZN	1	-	10	
92421	924212	175 mm	ZN	1	-	10	
92422	924229	100 mm	NE	1	-	10	
92423	924236	130 mm	NE	1	-	10	
92424	924243	150 mm	NE	1	-	10	
92425	924250	175 mm	NE	1	-	10	

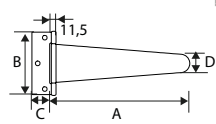

BISAGRA FORMA "T" BS8

	Código	8431488	Medida AxBxCxD	Acabado				€uros
Caja	36016	360164	75x75x25x20 mm	NE	-	10	100	
	36017	360171	100x95x28x25 mm	NE	-	10	100	
Blister	91511	915111	75x75x25x20 mm	NE	2	-	10	
	91512	915128	100x95x28x25 mm	NE	2	-	10	

Acero



NEGRO

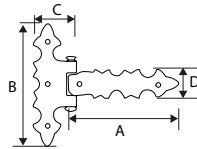

BISAGRA ALAS BS6

	Código	8431488	Medida	Acabado				€uros
Caja	36013	360133	80x65 mm	NE	-	10	100	
Blister	91508	915081	80x65 mm	NE	2	-	10	

Acero



NEGRO

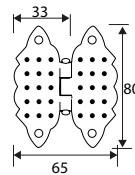

BISAGRA ALAS BS7

	Código	8431488	Medida AxBxC	Acabado				€uros
Caja	36014	360140	75x45x25 mm	NE	-	10	100	
	36015	360157	95x60x30 mm	NE	-	10	100	
Blister	91509	915098	75x45x25 mm	NE	2	-	10	
	91510	915104	95x60x30 mm	NE	2	-	10	

Acero



NEGRO

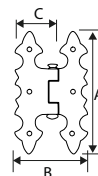

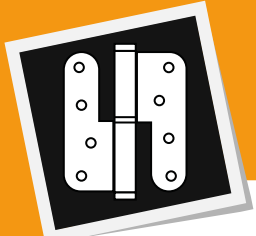

BISAGRA SOLAPADA C/REMATE BS24

	Código	843 1488	Medida A	Acabado				€uros
Caja	36007	360072	40 mm	LTD	-	25	250	
	36008	360089	40 mm	CB	-	25	250	
	36009	360096	40 mm	LE	-	25	250	
	36010	360102	53 mm	LTD	-	25	250	
	36011	360119	53 mm	CB	-	25	250	
	36012	360126	53 mm	LE	-	25	250	
Blister	90936	909363	40 mm	LTD	2	-	10	
	90937	909370	40 mm	CB	2	-	10	
	90938	909387	40 mm	LE	2	-	10	
	90939	909394	53 mm	LTD	2	-	10	
	90940	909400	53 mm	CB	2	-	10	
	90941	909417	53 mm	LE	2	-	10	

Incluye tornillos en el blister

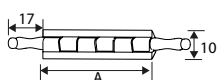

Zamak

LATONADO
 CROMO BRILLO
 LATÓN ENVEJECIDO

BISAGRA SOLAPADA S/REMATE BS25



	Código	843 1488	Medida A	Acabado				€uros
Caja	36001	360010	40 mm	LTD	-	25	625	
	36002	360027	40 mm	CB	-	25	625	
	36003	360034	40 mm	LE	-	25	625	
	36004	360041	53 mm	LTD	-	25	625	
	36005	360058	53 mm	CB	-	25	625	
	36006	360065	53 mm	LE	-	25	625	
Blister	90942	909424	40 mm	LTD	2	-	10	
	90943	909431	40 mm	CB	2	-	10	
	90944	909448	40 mm	LE	2	-	10	
	90945	909455	53 mm	LTD	2	-	10	
	90946	909462	53 mm	CB	2	-	10	
	90947	909479	53 mm	LE	2	-	10	

Incluye tornillos en el blister

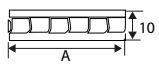

Zamak

LATONADO
 CROMO BRILLO
 LATÓN ENVEJECIDO

BISAGRA BIOMBO BS20



	Código	843 1488	Medida AxBxC	Acabado				€uros
Caja	67330	673301	50x20x0,9 mm	LTD	-	24	600	
	67331	673318	60x25x1,2 mm	LTD	-	24	240	
	67332	673325	60x30x1,5 mm	LTD	-	24	240	
Blister	91363	913636	50x20x0,9 mm	LTD	2	-	10	
	91364	913643	60x25x1,2 mm	LTD	2	-	10	
	91365	913650	60x30x1,5 mm	LTD	2	-	10	

Incluye tornillos en el blister

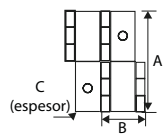

Acero

LATONADO

BISAGRA CAZOLETA 26 MM BC1

	Código	8431488	Tipo	Acabado				€uros
Caja	19221	192215	recta	ZN	-	24	240	
	19222	192222	acodada	ZN	-	24	240	
	19223	192239	superacodada	ZN	-	24	240	
Blister	90491	904917	recta	ZN	2	-	10	
	90492	904924	acodada	ZN	2	-	10	
	90493	904931	superacodada	ZN	2	-	10	

Acero



ZINCADO



Presentación en bolsa de 2 unidades



Incluye tornillos en el blister
Incluye base



BISAGRA CAZOLETA 35MM BC2

	Código	8431488	Tipo	Acabado				€uros
Caja	19201	192017	recta	ZN	-	24	240	
	19202	192024	acodada	ZN	-	24	240	
	19203	192031	superacodada	ZN	-	24	240	
Blister	90494	904948	recta	ZN	2	-	10	
	90495	904955	acodada	ZN	2	-	10	
	90496	904962	superacodada	ZN	2	-	10	

Acero



ZINCADO



Presentación en bolsa de 2 unidades



Incluye tornillos en el blister
Incluye base



BISAGRA CAZOLETA CLIP 35 MM BC3

	Código	8431488	Tipo	Acabado				€uros
Caja	19211	192116	recta	ZN	-	24	192	
	19212	192123	acodada	ZN	-	24	192	
	19213	192130	superacodada	ZN	-	24	192	
Blister	90497	904979	recta	ZN	2	-	10	
	90498	904986	acodada	ZN	2	-	10	
	90499	904993	superacodada	ZN	2	-	10	

Acero



ZINCADO



Presentación en bolsa de 2 unidades



Incluye tornillos en el blister
Incluye base



BISAGRA CAZOLETA CLIP C/TETÓN 35 MM BC4

	Código	8431488	Tipo	Acabado				€uros
Caja	19214	192147	recta	ZN	-	24	240	
	19215	192154	acodada	ZN	-	24	240	
	19216	192161	superacodada	ZN	-	24	240	

Acero



ZINCADO



Presentación en bolsa de 2 unidades



Incluye base
Tetón cazoleta D10 mm x L10,5 mm
Tetón base D5 mm x L5 mm



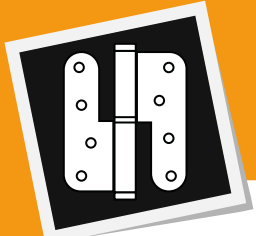

BISAGRA CAZOLETA C/PISTÓN 35 MM BC5



SOFT-CLOSE

	Código	843 I 488	Tipo	Acabado				€uros
Caja	19241	192413	recta	ZN	-	24	96	
	19242	192420	acodado	ZN	-	24	96	
	19243	192437	superacodada	ZN	-	24	96	
Blister	90501	905013	recta	ZN	2	-	10	
	90502	905020	acodado	ZN	2	-	10	
	90503	905037	superacodada	ZN	2	-	10	

Incluye tornillos en el blister
 Incluye base - Base triple regulación
 Incluye tapa embellecedora

Acero



ZINCADO

Presentación en bolsa de 2 unidades

BISAGRA CAZOLETA C/PISTÓN Y TETÓN 35 MM BC6

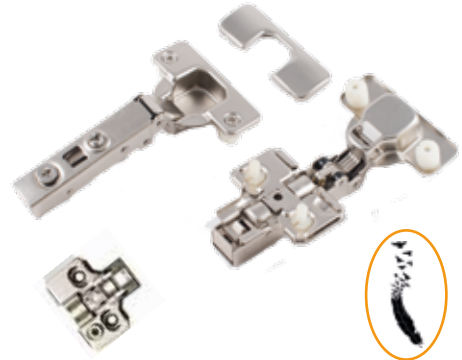

SOFT-CLOSE

	Código	843 I 488	Tipo	Acabado				€uros
Caja	19217	192178	recta	ZN	-	24	240	
	19218	192185	acodada	ZN	-	24	240	
	19219	192192	superacodada	ZN	-	24	240	

Incluye base - Base triple regulación
 Incluye tapa embellecedora
 Tetón cazoleta D10 mm x L10,5 mm
 Tetón base D5 mm x L5 mm

Acero



ZINCADO

Presentación en bolsa de 2 unidades

BISAGRA CAZOLETA PUSH 35 MM BC11



PUSH

	Código	843 I 488	Tipo	Acabado				€uros
Caja	19234	192345	recta	ZN	-	24	240	
	19235	192352	acodada	ZN	-	24	240	
	19236	192369	superacodada	ZN	-	24	240	

Incluye base
 Sistema de apertura de expulsión, es necesario montar con un toca-toca o expulsor para mantener la puerta cerrada

Acero



ZINCADO

Presentación en bolsa de 2 unidades



BISAGRA CAZOLETA CLIP 165° 35 MM BC7



	Código	843 I 488	Tipo	Acabado				€uros
Caja	19224	192246	recta	ZN	-	12	96	
	19229	192291	acodada	ZN	-	12	96	
	19230	192307	superacodada	ZN	-	12	96	

Incluye base

Acero



ZINCADO

Presentación en bolsa de 1 unidad

BISAGRA CAZOLETA 30° BC8

	Código	8431488	Medida	Acabado				€uros
Caja	19225	192253	35 mm	ZN	-	24	192	
Blister	91686	916866	35 mm	ZN	2	-	10	

Acero



ZINCADO



Presentación en bolsa de 2 unidades



Incluye tornillos en el blister
Incluye base



BISAGRA CAZOLETA 45° BC9

	Código	8431488	Medida	Acabado				€uros
Caja	19226	192260	35 mm	ZN	-	24	240	
Blister	91687	916873	35 mm	ZN	2	-	10	

Acero



ZINCADO



Presentación en bolsa de 2 unidades



Incluye tornillos en el blister
Incluye base



BISAGRA CAZOLETA 90° RINCONERA BC12

	Código	8431488	Medida	Acabado				€uros
Caja	19237	192376	35 mm	ZN	-	24	192	
Blister	91872	918723	35 mm	ZN	2	-	10	

Acero



ZINCADO



Presentación en bolsa de 2 unidades



Incluye tornillos en el blister
Incluye base

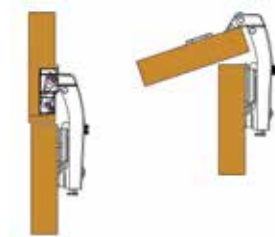

BISAGRA CAZOLETA 90° RINCONERA C/PISTÓN BC13

	Código	8431488	Medida	Acabado				€uros
Caja	19238	192383	35 mm	ZN	-	24	96	
Blister	92183	921839	35 mm	ZN	2	-	10	

Acero



ZINCADO



Presentación en bolsa de 2 unidades



Incluye tornillos en el blister
Incluye base - Base triple regulación



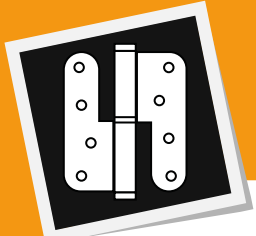

BISAGRA CAZOLETA SOBREPONER BC10

	Código	8431488	Tipo	Acabado				€uros
Caja	10092	109213	104x44 mm	ZN	-	25	250	
Blister	90504	905044	104x44 mm	ZN	2	-	10	

Incluye tornillos en el blister

Acero

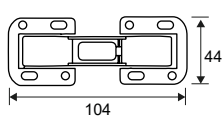

BASE AVIÓN CLIPTRIPLE REGULACIÓN BC5

	Código	8431488	Tipo	Acabado				€uros
Caja	19228	192284	53x46 mm	ZN	-	50	500	

Acero

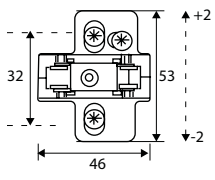

TAPA EMBELLECEDOR BC5

	Código	8431488	Tipo	Acabado				€uros
Caja	19227	192277	63x22 mm	ZN	-	100	1000	

Acero

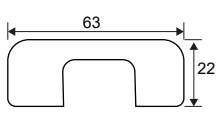

TORNILLO BISAGRA TRN5

	Código	8431488	Medida	Acabado				€uros
Caja	43516	435169	3,5x16 mm	NI	-	1000	10000	
	44016	440163	4,0x16 mm	NI	-	1000	10000	
Blister	90209	902098	3,5x16 mm	NI	20	-	10	
	90210	902104	4,0x16 mm	NI	20	-	10	

Acero

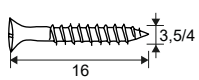

Te sugiero:

TORNILLO Q EURO
Pág. 277

TAPÓN BISAGRA
Pág. 262