

AVELLANADORES

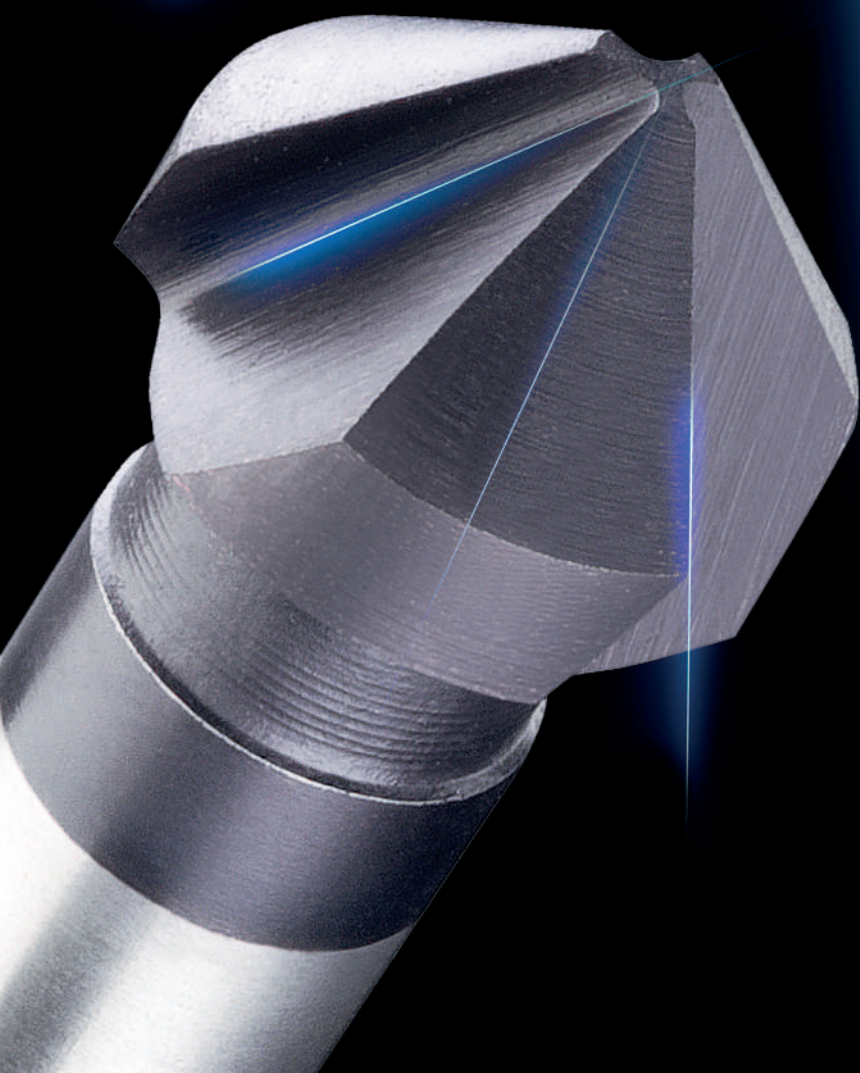

BROCAS AVELLANADORAS PARA TUBO Y CHAPA HSS Y HSSCo
HSS

Ref. AV30

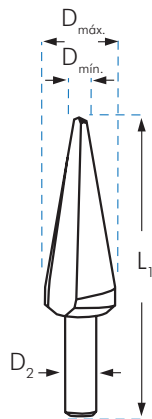

AV30

	D mín. mm	D máx. mm	D ₂ mm	L ₁ mm	HSS	TiN
					€	€
AV30BM0B	3,0	14,0	6,0	58	18,09	37,92
AV30BM8B	3,0	22,5	8,0	85	50,03	95,06
AV30BM5B	3,0	31,0	10,0	102	80,00	125,71
AV30BM9B	5,0	25,4	10,0	87	56,89	113,95
AV30BM1B	6,0	20,0	8,0	63	25,53	55,34
AV30BM2B	16,0	30,0	10,0	79	49,38	91,57
AV30BM3B	26,0	40,0	13,0	86	102,17	167,76
AV30BM4	36,0	50,0	13,0	89	150,48	243,40
AV30BM6	40,0	61,0	13,0	98	249,30	407,08

* Las referencias acabadas en B, se suministran en blíster.

HSSCo

Ref. AVC30

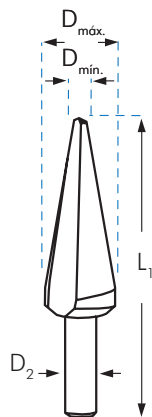

AVC30

	D mín. mm	D máx. mm	D ₂ mm	L ₁ mm	HSSCo	TiN
					€	€
AVC30BM0B	3,0	14,0	6,0	58	33,49	45,87
AVC30BM1B	6,0	20,0	8,0	63	44,41	70,72
AVC30BM2B	16,0	30,0	10,0	79	73,28	102,44
AVC30BM3B	26,0	40,0	13,0	86	190,66	215,74

BROCAS AVELLANADORAS PARA CHAPA HSS CARACTERISTICAS ESPECIALES

HSS

Ref. AG

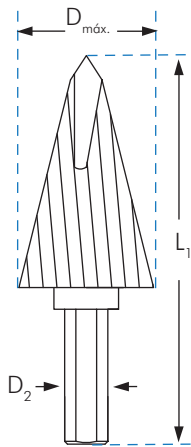

FRESA PARA TUBO Y CHAPA

	D máx. mm	D ₂ mm	L ₁ mm	N° dientes	AG	
					HSS	€
AG2500	25,0	8,0	72	20	HSS	25,55
AG3200	32,0	10,0	81	30	HSS	38,36
AG4500	45,0	10,0	94	36	HSS	63,36

HSS

Ref. AV31



TOPE DE PROFUNDIDAD

	D _{mín.} mm	D _{máx.} mm	D ₂ mm	L ₁ mm	AV31	
					HSS	TiN
					€	€
AV31BM0B	3,0	7,8	6,0	48	29,00	46,02
AV31BM1B	3,0	10,2	6,0	52	38,08	62,61
AV31BM2B	3,0	11,8	6,0	56	42,38	78,52

BROCAS ESCALONADAS DE CANALES RECTOS HSS



Ref. AV40

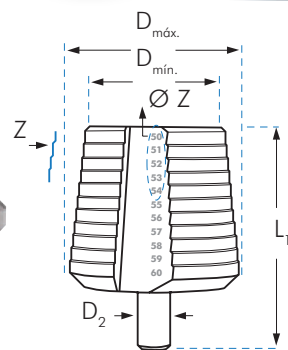
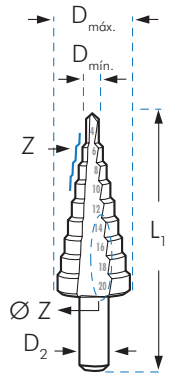

BM1 BM2 BM3 BM4 BM5 Ref. AV40BM25 / 26 / 27 / 28 / 29

AV40

	D min. mm	D max. mm	D2 mm	L1 mm	Z	Ø Z mm menor-mayor	HSS	TiN
							€	€
AV40BM1B	4,0	12,0	6,0	65	5	4-6-8-10-12	38,78	60,56
AV40BM2B	4,0	12,0	6,0	65	9	4-5-6-7-8-9-10-11-12	38,62	60,91
AV40BM3B	4,0	20,0	8,0	69	9	4-6-8-10-12-14-16-18-20	49,51	77,75
AV40BM4B	4,0	30,0	10,0	96	14	4-6-8-10-12-14-16-18-20-22-24-26-28-30	81,22	147,73
AV40BM14	4,0	39,0	10,0	107	13	4-6-9-12-15-18-21-24-27-30-33-36-39	195,92	317,23
AV40BM16B	5,0	28,0	10,0	69	7	5-8-8-11,8-15,3-19-24,5-28	90,88	149,96
AV40BM35B	5,0	35,0	13,0	80	13	5-7-10-12-15-17-20-22-25-27-30-32-35	127,06	184,74
AV40BM11B	6,0	25,0	10,0	65	7	6-9-12-16-20-22,50-25	74,21	111,43
AV40BM10B	6,0	26,7	10,0	75	8	6-9-11,40-14-17,25-19-21,25-26,75	144,49	238,41
AV40BM17B	6,0	30,5	10,0	80	9	6-9-12,5-15,2-18,6-20,4-22,5-28,3-30,5	153,41	253,12
AV40BM12B	6,0	32,0	10,0	75	9	6-9-12-16-20-22,5-25-28,5-32	104,74	150,14
AV40BM18B	6,0	37,0	10,0	100	12	6-9-12,5-15,2-18,6-20,4-22,5-26-28,3-30,5-34-37	170,49	277,09
AV40BM5B	6,0	38,0	10,0	96	12	6-9-13-16-19-21-23-26-29-32-35-38	183,94	275,77
AV40BM13	6,0	40,0	13,0	105	16	6-11-17-23-29-30-31-32-33-34-35-36-37-38-39-40	253,66	326,81
AV40BM15B	6,5	32,5	10,0	79	9	6,50-8,50-10,50-12,50-16,50-20,50-25,50-29-32,50	121,27	178,20
AV40BM20	6,5	40,5	10,0	96	11	6,50-8,50-10,50-12,50-16,50-20,50-25,50-29-32,50-36,50-40,50	190,12	313,71
AV40BM21B	7,0	20,0	10,0	80	12	7-10-11-12-13-14-15-16-17-18-19-20	76,07	125,51
AV40BM22B	10,0	30,0	13,0	83	12	10-20-21-22-23-24-25-26-27-28-29-30	119,07	195,88
AV40BM25B	12,0	20,0	8,0	66	9	12-13-14-15-16-17-18-19-20	70,53	98,98
AV40BM26B	20,0	30,0	10,0	78	11	20-21-22-23-24-25-26-27-28-29-30	102,89	151,97
AV40BM27	30,0	40,0	10,0	78	11	30-31-32-33-34-35-36-37-38-39-40	154,10	208,03
AV40BM28	40,0	50,0	13,0	85	11	40-41-42-43-44-45-46-47-48-49-50	220,30	321,94
AV40BM29	50,0	60,0	13,0	85	11	50-51-52-53-54-55-56-57-58-59-60	277,57	361,53

PARA PASAR TUBERÍAS ROSCA GAS

AV40BM6B	6,0	32,0	10,0	75	8	6-9-11,20(1/8)-14,50(1/4)-18,20(3/8)-22,30(1/2)-27,90(3/4)-32	108,67	156,19
----------	-----	------	------	----	---	---	--------	--------

PARA REMACHES CIEGOS M3 - M4 - M5 - M6 Y M7

AV40BM7B	4,8	10,6	6,0	54	5	4,80-6,40-7,20-9,60-10,65	35,41	52,97
----------	-----	------	-----	----	---	---------------------------	-------	-------

PARA CONDUCCIONES ELÉCTRICAS (ANTIGUA Y NUEVA NORMA)

AV40PG21B	PG7	PG21	13,0	70	6	PG7-PG9-PG11-PG13,50-PG16-PG21	119,66	177,38
AV40PG29B	PG7	PG29	13,0	81	7	PG7-PG9-PG11-PG13,50-PG16-PG21-PG29	154,58	227,38
AV40BM8B	8,5	32,5	10,0	70	12	8,5-10,5-12,5-14,5-16,5-18,5-20,5-23,5-25,5-28-30,5-32,5	90,71	146,25
AV40BM9B	8,5	40,5	12,0	84	16	8,5-10,5-12,5-14,5-16,5-18,5-20,5-23,5-25,5-28-30,5-32,5-34,5-36,5-38,5-40,5	143,69	224,93

BROCAS ESCALONADAS DE CANALES RECTOS HSSCo

HSSCo **INOX** Ref. AVC40

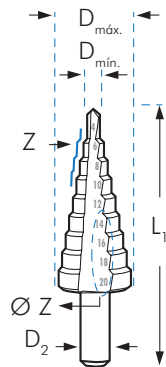

BM1 BM2 BM3 BM4 BM18



							AVC40	
	D mín. mm	D máx. mm	D ₂ mm	L ₁ mm	Z	Ø Z mm menor-mayor	HSSCo €	TiN €
AVC40BM1B	4,0	12,0	6,0	65	5	4-6-8-10-12	57,96	87,70
AVC40BM2B	4,0	12,0	6,0	65	9	4-5-6-7-8-9-10-11-12	61,20	105,92
AVC40BM3B	4,0	20,0	8,0	69	9	4-6-8-10-12-14-16-18-20	92,51	120,01
AVC40BM4B	4,0	30,0	10,0	96	14	4-6-8-10-12-14-16-18-20-22-24-26-28-30	133,06	188,13
AVC40BM18B	6,0	37,0	10,0	100	12	6-9-12,5-15,2-18,6-20,4-22,5-26-28,3-30,5-34-37	238,36	316,07

BROCAS ESCALONADAS DE CANALES HELICOIDALES HSS

HSS Ref. AV42

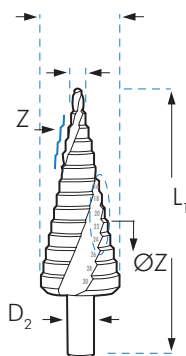

BM2 BM3 BM4



							AV42	
	D mín. mm	D máx. mm	D ₂ mm	L ₁ mm	Z	Ø Z mm menor-mayor	HSS €	TiN €
AV42BM1B	4,0	12,0	6,0	65	5	4-6-8-10-12	49,80	70,61
AV42BM2B	4,0	12,0	6,0	68	9	4-5-6-7-8-9-10-11-12	51,51	73,53
AV42BM3B	4,0	20,0	8,0	69	9	4-6-8-10-12-14-16-18-20	68,70	102,81
AV42BM4B	4,0	30,0	10,0	96	14	4-6-8-10-12-14-16-18-20-22-24-26-28-30	109,29	163,67
AV42BM5B	6,0	38,0	10,0	96	12	6-9-13-16-19-21-23-26-29-32-35-38	213,17	291,97
AV42BM11B	6,0	25,0	10,0	65	7	6-9-12-16-20-22,50-25	88,45	120,58
AV42BM12B	6,0	32,0	10,0	75	9	6-9-12-16-20-22,5-25-28,5-32	115,37	151,75
AV42BM13	6,0	40,0	13,0	105	16	6-11-17-23-29-30-31-32-33-34-35-36-37-38-39-40	254,66	344,75
AV42BM8B	8,5	32,5	10,0	70	12	8,5-10,5-12,5-14,5-16,5-18,5-20,5-23,5-25,5-28-30,5-32,5	116,44	157,80
AV42BM9B	8,5	40,5	12,0	84	16	8,5-10,5-12,5-14,5-16,5-18,5-20,5-23,5-25,5-28-30,5-32,5-34,5-36,5-38,5-40,5	183,11	233,52

BROCAS ESCALONADAS HSS CARACTERÍSTICAS ESPECIALES
HSS
MANGO HEXAGONAL 1/4"

	D mín. mm	D máx. mm		L ₁ mm	Z	Ø Z mm menor-mayor	AV41	
							HSS €	TiN €
AV41BM2B	4,0	12,0	1/4"	72	9	4-5-6-7-8-9-10-11-12	82,85	107,72
AV41BM3B	4,0	20,0	1/4"	81	9	4-6-8-10-12-14-16-18-20	109,53	142,44
AV41BM4B	4,0	30,0	1/4"	105	14	4-6-8-10-12-14-16-18-20-22-24-26-28-30	129,82	163,98



Ref. AV41BM2B

SERIE CORTA Máximo 2 mm de espesor

	D mín. mm	D máx. mm	D ₂ mm	L ₁ mm	Z	Ø Z mm menor-mayor	AV41C	
							HSS €	TiN €
AV41CBM2B	4,0	12,0	6,0	48	9	4-5-6-7-8-9-10-11-12	58,95	82,97
AV41CBM3B	4,0	20,0	8,0	58	9	4-6-8-10-12-14-16-18-20	73,19	107,23
AV41CBM4B	4,0	30,0	10,0	72	14	4-6-8-10-12-14-16-18-20-22-24-26-28-30	119,32	192,64



Ref. AV41CBM3B

ATORNILLAMIENTOS MÉTRICOS DE CABLE

	DIN	D mín. mm	D máx. mm	D ₂ mm	L ₁ mm	Z	Ø Z mm menor-mayor	AV45	
								HSS €	TiN €
AV45BM0B	60423	5,3	30,5	10,0	79	9	5,3-7-9-10,5-14,5-18,5-23,5-27-30,5	162,66	219,93
AV45BM2B	60423	5,3	38,5	10,0	96	11	5,3-7-9-10,5-14,5-18,5-23,5-27-30,5-34,5-38,5	195,60	259,13



Ref. AV45BM2B

ESCALONADA RECTA CON 3 CORTES

	D mín. mm	D máx. mm	D ₂ mm	L ₁ mm	Z	Ø Z mm menor-mayor	AV43	
							HSS €	TiN €
AV43BM1B	4,0	12,0	6,0	65	9	4-5-6-7-8-9-10-11-12	71,06	97,49
AV43BM2B	4,0	20,0	8,0	75	9	4-6-8-10-12-14-16-18-20	97,42	158,27
AV43BM3B	4,0	30,0	10,0	100	14	4-6-8-10-12-14-16-18-20-22-24-26-28-30	143,22	245,62



Ref. AV43BM3B

BROCA ESCALONADA CON BROCA GUÍA INTERCAMBIABLE

	D mín. mm	D máx. mm	D ₂ mm	L ₁ mm	Z	Ø Z mm menor-mayor	AV4	
							HSS €	TiN €
AV4BM3040	30,0	40,0	13,0	76	11	30-31-32-33-34-35-36-37-38-39-40	151,89	
AV4BM4050	40,0	50,0	13,0	76	11	40-41-42-43-44-45-46-47-48-49-50	219,38	
AV4BM5060	50,0	60,0	13,0	76	11	50-51-52-53-54-55-56-57-58-59-60	278,48	



Ref. AV4BM3040

BROCA GUÍA

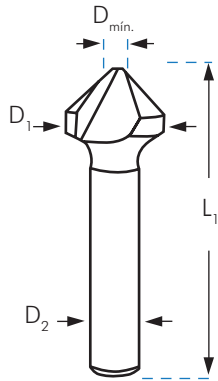

		BAV4BM
		€
BAV4BM	DESCRIPCIÓN	
	10X35mm	9,83

AVELLANADORES DE 3 CANALES

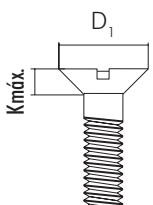

				AV6	AV16	AV37	AV7	AV38	AV99	AV6MD	AV15	
MATERIAL				HSS	HSS	HSS	HSSCo	HSSCo	HSSCo	MD	HSS	
ACABADO					TiN	TiAlN		TiAlSiN	TiAlN	HARDOX 600		
APLICACIÓN				USO GENERAL	USO GENERAL	USO GENERAL	USO GENERAL INOX	INOX Plus	INOX Synterplus	MATERIAL DURO		
D1 mm	D mín. mm	D2 mm	L1 mm	€	€	€	€	€	€	€	L1 mm	€
4,30	1,3	4,0	40	16,54	30,55	35,96	18,40	43,93		62,05		
5,00	1,5	4,0	40	16,54	30,55	35,96	18,40	43,93				
5,30	1,5	4,0	40	16,54	30,55	35,96	18,40	43,93		59,74		
5,80	1,5	5,0	45	12,56	26,84	33,75	14,97	38,46				
6,00	1,5	5,0	45	11,97	26,25	33,75	14,39	37,99		61,73		
6,30	1,5	5,0	45	11,75	26,25	33,75	14,12	37,78	38,20	66,74		
7,00	1,8	6,0	50	16,54	35,05	45,02	18,40	51,09				
7,30	1,8	6,0	50	16,54	35,05	45,02	18,40	51,09				
8,00	2,0	6,0	50	16,54	35,05	45,02	18,59	51,24		71,09		
8,30	2,0	6,0	50	16,29	35,05	45,02	18,25	50,95	51,52	75,82		
9,40	2,2	6,0	50	19,28	39,55	50,44	21,52	58,00				
10,00	2,5	6,0	50	19,28	39,55	50,44	21,52	58,00		78,37		
10,40	2,5	6,0	50	18,93	39,55	50,44	21,97	57,84	58,48	82,70	112	57,77
11,50	2,8	8,0	56	19,38	41,90	54,24	23,48	62,87				
12,00	2,8	8,0	56	19,38	41,90	54,24	23,48	62,88				
12,40	2,8	8,0	56	19,38	41,90	54,24	23,47	62,88	63,58	86,24	112	71,12
13,40	2,9	8,0	56	20,95	43,28	56,02	25,61	65,85				
15,00	3,2	10,0	60	26,60	58,16	76,70	32,61	88,10		89,81		
16,50	3,2	10,0	60	26,16	59,73	76,70	32,17	87,71	88,69	94,44	120	85,70
19,00	3,5	10,0	63	39,18	72,87	93,08	48,24	107,11				
20,50	3,5	10,0	63	38,51	74,42	95,88	47,36	108,48	109,68	130,95	124	114,87
23,00	3,8	10,0	67	48,16	84,78	107,29	58,78	125,97				
25,00	3,8	10,0	67	48,59	85,98	108,41	59,83	127,65	129,07	213,68	128	138,54
28,00	4,0	12,0	71	67,86	109,29	140,28	85,44	171,55				
30,00	4,2	12,0	71	72,11	113,40	182,81	90,37	206,88				
31,00	4,2	12,0	71	75,07	117,54	196,31	90,37	202,40		241,11	133	162,29
40,00	6,5	13,0	80	111,62	179,39	230,81	141,08	252,59		418,63*		

* Mango de 16 mm



DIN 7991

DIMENSIONES TORNILLO CABEZA CÓNICA 90°

	M2	M2.5	M3	M4	M5	M6	M8	M10	M12	M14	M16	M18	M20
Kmáx.	1,2	1,5	1,7	2,3	2,8	3,3	4,4	5,5	6,5	7	7,5	8	8,5
D1	4	5	6	8	10	12	16	20	24	27	30	33	36

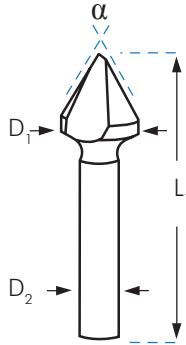
AVELLANADORES HSS MANGO CILÍNDRICO 60°, 75°, 120°
3Z

					AV8		AV9		AV10
MATERIAL					HSS		HSS		HSS
NORMA					DIN 334C		NORMA CELESA		NORMA CELESA
ÁNGULO DE PUNTA									
D1 mm	D mín mm	D2 mm	L1 mm		€		€		€
6,30	1,5	5,0	45	AV80630	18,57	AV90630	14,30	AV100630	15,22
8,00	2,0	6,0	50	AV80800	20,42				
8,30	2,0	6,0	50			AV90830	19,49	AV100830	20,97
10,00	2,5	6,0	50	AV81000	22,27				
10,40	2,5	6,0	50			AV91040	23,03	AV101040	24,51
12,40	2,8	8,0	56	AV81250	24,69	AV91240	25,44	AV101240	29,34
16,50	3,2	10,0	60	AV81600	31,58	AV91650	31,92	AV101650	37,13
20,50	3,5	10,0	63	AV82000	44,57	AV92050	46,98	AV102050	54,78
25,00	3,8	10,0	67	AV82500	62,20	AV92500	59,22	AV102500	69,08
40,00	6,5	13,0	67	AV84000	142,91	AV94000	128,85	AV104000	151,84

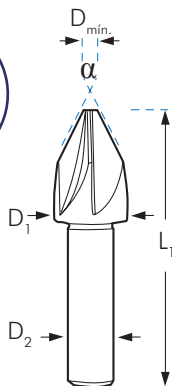
AVELLANADORES MULTICORTE MANGO CILÍNDRICO 60°, 90° Y 120°
5Z

					AV12		AV11		AV13			
MATERIAL					HSS		HSS		HSS			
DIN					DIN 334A		DIN 335A		DIN 347A			
ÁNGULO DE PUNTA												
D1 mm	D mín mm	D2 mm	Nº Z	L1 mm	€	L1 mm	€	L1 mm	€			
8,00	2,5	8,0	5	AV120800	48	16,23	AV110800	44	12,20	AV130800	44	16,18
12,50	2,8	8,0	5	AV121250	52	22,71	AV111250	48	17,88	AV131250	48	23,75
16,00	3,0	10,0	5	AV121600	60	38,11	AV111600	56	30,02	AV131600	56	39,84
20,00	3,5	10,0	5	AV122000	64	49,16	AV112000	60	38,67	AV132000	60	51,37
25,00	3,5	10,0	5	AV122500	69	68,81	AV112500	65	54,13	AV132500*	65	69,88

* D2: 12,00 mm

AVELLANADORES HSS Y HSSCo PARA DESBARBAR CON AGUJERO

Avellanadores

Rosa

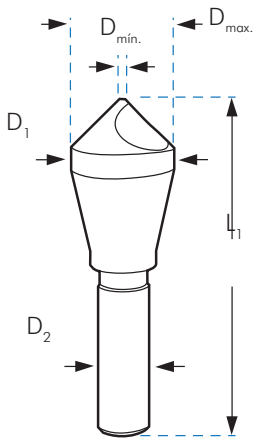

MATERIAL					AV1	AV1T	AV2	AV2T	AV1-60					
ACABADO						TiN		TiN						
ÁNGULO DE PUNTA					90°	90°	90°	90°	60°					
D1 mm	D _{mín} mm	D _{max} mm	D2 mm	L1 mm	€	€	€	€	€					
6,35	2,0	5,0	6,35	45	AV100	13,25	AV100T	24,62	AV200	22,52	AV200T	38,96	AV100-60	23,73
10,00	2,0	5,0	6,00	45	AV101	16,33	AV101T	25,75	AV201	23,26	AV201T	38,96	AV101-60	29,65
14,00	6,0	13,0	8,00	50	AV102	20,41	AV102T	36,20	AV202	27,08	AV202T	48,58	AV102-60	35,99
20,00	8,0	18,0	10,00	65	AV103	36,54	AV103T	64,72	AV203	48,42	AV203T	82,23	AV103-60	41,06
27,00	11,0	25,0	12,00	85	AV104	65,30	AV104T	106,40	AV204	78,89	AV204T	129,54	AV104-60	71,53
30,00	12,0	28,0	15,00	95	AV105	110,20	AV105T	201,91	AV205	125,34	AV205T	222,59	AV105-60	117,22
35,00	14,0	33,0	15,00	100	AV106	169,26	AV106T	276,48	AV206	210,01	AV206T	374,33	AV106-60	185,77
40,00	16,0	38,0	15,00	110	AV107	233,69	AV107T	392,93	AV207	241,63	AV207T	401,06	AV107-60	251,77
45,00	18,0	42,0	15,00	120	AV108	309,64	AV108T	477,23	AV208	363,13	AV208T	532,05	AV108-60	325,39
55,00	20,0	53,0	15,00	130	AV109	373,60	AV109T	554,84	AV209	483,98	AV209T	667,98	AV109-60	396,47

AVELLANADOR CÓNICO 90° MULTILABIO

Ref. FC

TiAlN

MD

90°

D1 mm	D2 mm	L mm	L2 mm	D3 mm	Z	FC	€
0,5	0,1	39,0	3,0	3,0	3	FC0050	59,21
0,6	0,1	39,0	3,0	3,0	3	FC0060	59,21
0,7	0,1	39,0	3,0	3,0	3	FC0070	59,21
0,8	0,1	39,0	3,0	3,0	3	FC0080	59,21
0,9	0,1	39,0	3,0	3,0	3	FC0090	59,21
1,0	0,1	39,0	3,0	3,0	3	FC0100	57,17
1,5	0,1	39,0	4,5	3,0	3	FC0150	57,17
2,0	0,1	39,0	6,0	3,0	3	FC0200	57,17
2,5	0,1	39,0	7,5	3,0	3	FC0250	57,17
3,0	0,1	39,0	-	3,0	3	FC0300	57,17
4,0	0,8	54,0	-	4,0	4	FC0400	59,21
6,0	0,8	57,0	-	6,0*	4	FC0600	62,27
8,0	0,8	63,0	-	8,0*	5	FC0800	68,40
10,00	1,0	72,0	-	10,0*	6	FC1000	81,67
12,00	1,2	83,0	-	12,0*	6	FC1200	120,46
16,00	1,6	92,0	-	16,0*	6	FC1600	215,40
20,00	2,0	104,0	-	20,0*	6	FC2000	394,04

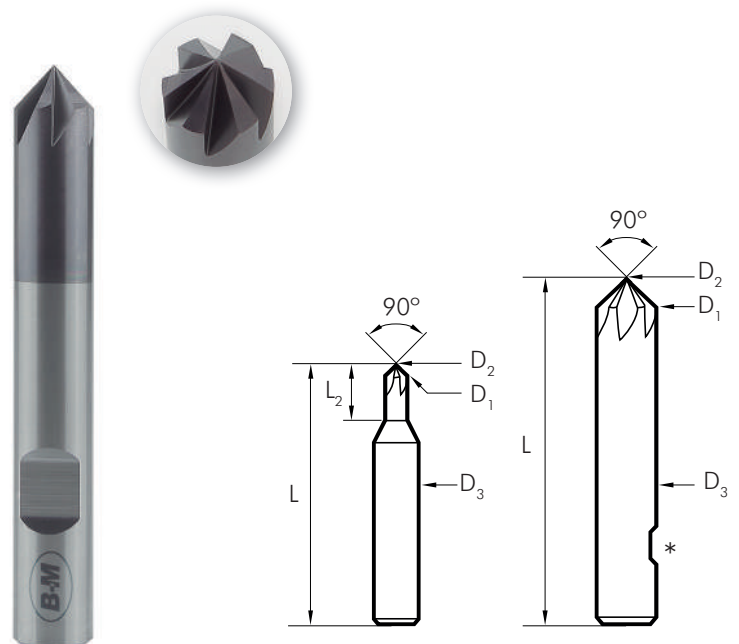

*Con plano de arrastre

AVELLANADORES CON MANGO CÓNICO
3Z

Ref. AV17

**DIN
335D**
HSS

90°

Ref. AV17MD

**DIN
335D**
MD

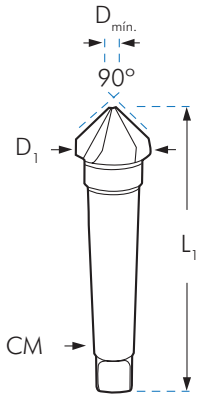
90°

AV17

D1 mm	D mín. mm	L1 mm	CM	€
16,50	4,0	90	1	77,82
20,50	3,5	100	2	91,75
25,00	3,8	106	2	92,69
31,00	4,2	112	2	103,18
40,00	10,0	140	3	158,78
50,00	14,0	150	3	199,87
63,00	16,0	180	4	323,17
80,00	22,0	190	4	552,94
100,00	25,0	210	4	1.425,09

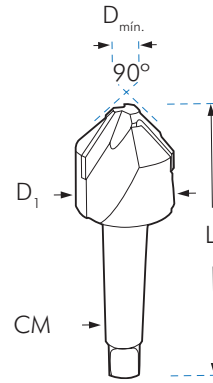

AV17MD

D1 mm	D mín. mm	L1 mm	CM	€
50,00	14,0	123	3	1.130,90
63,00	16,0	190	4	1.352,58
80,00	22,0	190	4	1.651,24

AVELLANADORES MULTICORTE CON MANGO CÓNICO
**MULTI
CORTE**

Ref. AV23

**DIN
334B**

60°

Ref. AV18

**DIN
335B**

90°

Ref. AV24

**DIN
347B**

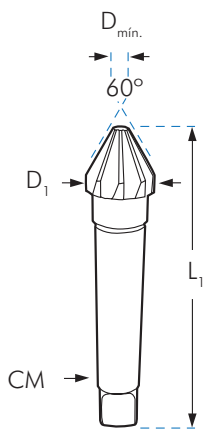
120°

AV23

D1 mm	D mín. mm	L1 mm	CM	Z	HSS €
16,00	3,2	93	1	7	59,05
20,00	4,0	116	2	7	69,12
25,00	7,0	121	2	9	75,71
31,50	9,0	124	2	9	103,53
40,00	12,5	150	3	11	189,47
50,00	16,0	153	3	13	226,49
63,00	20,0	185	4	15	346,73
80,00	25,0	196	4	17	535,87
100,00	22,0	230	4	3	1.688,56

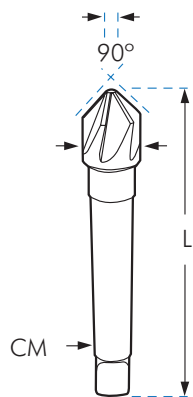

AV18

D1 mm	D mín. mm	L1 mm	CM	Z	HSS €
16,00	3,2	93	1	7	60,22
20,00	4,0	116	2	7	70,43
25,00	7,0	121	2	9	77,23
31,50	9,0	124	2	9	105,63
40,00	12,5	150	3	11	193,31
50,00	16,0	153	3	13	230,96
63,00	20,0	185	4	15	331,59
80,00	25,0	196	4	17	546,63
100,00	22,0	190	4	20	1.473,51

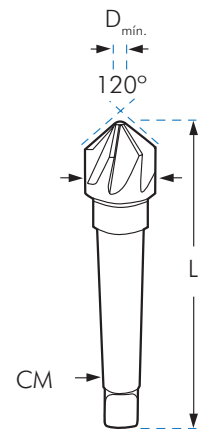

AV24

D1 mm	D mín. mm	L1 mm	CM	Z	HSS €
16,00	3,2	93	1	7	61,32
20,00	4,0	116	2	7	71,77
25,00	7,0	121	2	9	82,43
31,50	9,0	124	2	9	107,53
40,00	12,5	150	3	11	171,21
50,00	16,0	153	3	13	221,15
63,00	20,0	185	4	15	360,06
80,00	25,0	196	4	17	556,48
100,00	27,0	210	4	3	1.460,49



AVELLANADORES DE 1 CANAL



HSS MANGO CILÍNDRICO
Ref. AV27
Ref. AV29



HSS MANGO CÓNICO
Ref. AV34
Ref. AV28

	D1 mm	D2 mm	L1 mm	 90° €	 60° €
AV270600	6,0	6,0	45	12,75	AV290600 23,52
AV270800	8,0	8,0	50	13,46	AV290800 24,63
AV271000	10,0	8,0	50	14,27	AV291000 25,79
AV271200	12,0	8,0	50	16,61	AV291200 28,97
AV271600	16,0	10,0	56	19,79	AV291600 35,28
AV272000	20,0	10,0	60	27,04	AV292000 45,34
AV272500	25,0	10,0	75	35,62	AV292500 71,40
AV273000	30,0	12,0	80	51,38	AV293000 93,24
AV274000	40,0	13,0	89	133,88	AV294000 162,07
AV275000	50,0	13,0	98	165,29	AV295000 242,13

	D1 mm	CM	L1 mm	 90° €	 60° €
AV341600	16,0	1	92	61,30	AV281600 58,65
AV342000	20,0	2	107	76,82	AV282000 64,25
AV342500	25,0	2	110	98,93	AV282500 95,26
AV343000	30,0	2	114	112,42	AV283000 125,53
AV344000	40,0	3	145	180,88	AV284000 165,28
AV345000	50,0	3	152	264,12	AV285000 251,00

AVELLANADORES EXTERNOS DE 3 CORTES

3Z Ref. AVX

HSS  90°

Ref. AVX-60

HSS  60°

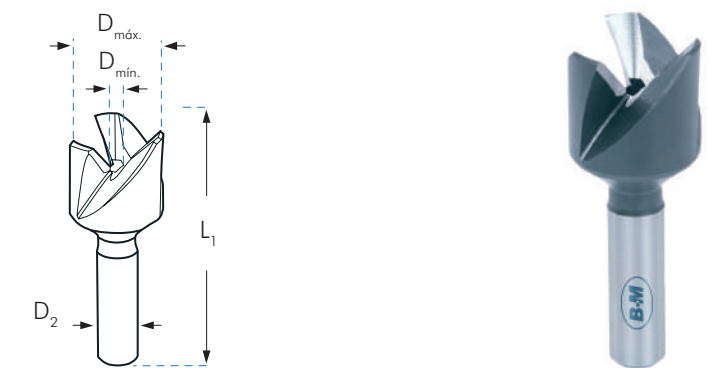
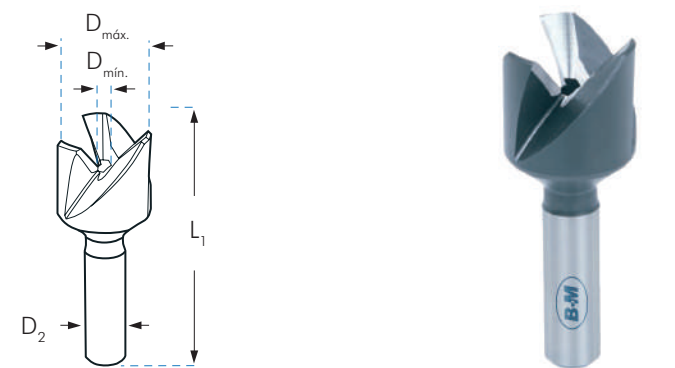

D máx. mm	D mín. mm	D2 mm	L1 mm		€
12,00	4,0	8,0	55	AVX1	53,35
20,00	8,0	10,0	60	AVX2	99,39
28,00	10,0	13,0	70	AVX3	140,99
40,00	12,0	CM2	125	AVX4	213,95
50,00	15,0	CM3	130	AVX5	298,92

D máx. mm	D mín. mm	D2 mm	L1 mm		€
8,00	3,0	8,0	55	AVX1-60	56,99
15,00	6,0	10,0	60	AVX2-60	109,37
28,00	10,0	13,0	75	AVX3-60	163,91

AVELLANADORES PARA ASIENTOS DE TORNILLOS «ALLEN»

MANGO CILÍNDRICO

DIN
373
HSS

Ref. AV2

NOTA: La longitud de corte se entiende sin la guía.

* El ajuste grueso se utiliza para avellanar agujeros roscados.

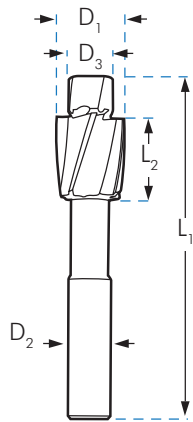

AV2M

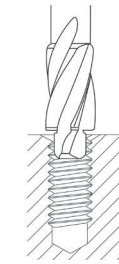

AV2MM

 Para avellanar
 Orificios roscados

AV2GM

AJUSTE					AV2M		AV2MM		AV2GM				
	D1 mm	D2 mm	L1 mm	L2 mm		FINO €		MEDIO €		AGUJERO ROSCADO €			
					D3 mm		D3 mm		D3 mm				
M3	6,0	5,0	71	14	AV2M3	3,2	22,79	AV2MM3	3,4	24,67	AV2GM3	2,5	24,67
M4	8,0	5,0	71	14	AV2M4	4,3	22,79	AV2MM4	4,5	24,67	AV2GM4	3,3	24,67
M5	10,0	8,0	80	18	AV2M5	5,3	22,79	AV2MM5	5,5	24,67	AV2GM5	4,2	24,67
M6	11,0	8,0	80	18	AV2M6	6,4	25,69	AV2MM6	6,6	27,81	AV2GM6	5,0	27,81
M7	20,0	12,7	90	20	AV2M7	7,4	47,43						
M8	15,0	12,5	100	22	AV2M8	8,4	31,84	AV2MM8	9,0	34,47	AV2GM8	6,8	34,47
M9	22,0	16,0	100	22	AV2M9	9,4	47,43						
M10	18,0	12,5	100	22	AV2M10	10,5	37,91	AV2MM10	11,0	41,04	AV2GM10	8,5	41,04
M11	22,0	18,8	100	22	AV2M11	11,5	50,46						
M12	20,0	12,5	100	22	AV2M12	13,0	44,22	AV2MM12	14,0	47,87	AV2GM12	10,2	47,87
M14	24,0	12,5	100	22	AV2M14	15,0	69,17	AV2MM14	15,5	74,88	AV2GM14	12,0	74,88
M16	26,0	12,5	100	22	AV2M16	17,0	76,08	AV2MM16	17,5	82,36	AV2GM16	14,0	82,36

CABEZA CÓNICA CON GUÍA

DIN
1866
HSS

Ref. AV3

NOTA: La longitud de corte se entiende sin la guía.

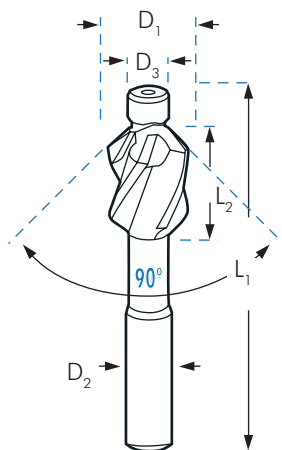

AJUSTE							AV3	
	D1 mm	D2 mm	L1 mm	L2 mm		D3 mm	FINO €	
M3	6,3	6,0	71	14,0	AV3M3	3,2	31,46	
M4	8,3	8,0	71	14,0	AV3M4	4,3	31,46	
M5	10,4	10,0	80	18,0	AV3M5	5,3	31,46	
M6	12,4	10,0	80	18,0	AV3M6	6,4	35,75	
M8	16,5	12,0	100	22,0	AV3M8	8,4	43,75	
M10	20,5	12,0	100	22,0	AV3M10	10,5	47,33	
M12	24,5	13,0	110	25,0	AV3M12	13,0	57,69	

AVELLANADORES PARA ASIENTOS DE TORNILLOS «ALLEN»

MANGO CÓNICO

Ref. AV5

**DIN
375**

HSS

NOTA: La longitud de corte se entiende sin la guía.
* El ajuste grueso se utiliza para avellanar agujeros roscados.

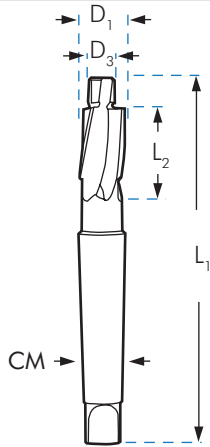

PARA AVELLANAR
ORIFICIOS ROSCADOS



AV5M

AV5MM

AV5GM

AJUSTE					FINO			MEDIO			AGUJERO ROSCADO		
	D1 mm	CM	L1 mm	L2 mm	D3 mm	€	D3 mm	€	D3 mm	€	D3 mm	€	
M8	15,0	2	132	22	AV5M8	8,4	62,29	AV5MM8	9,0	62,29	AV5GM8	6,8	62,29
M10	18,0	2	140	25	AV5M10	10,5	63,93	AV5MM10	11,0	63,93	AV5GM10	8,5	63,93
M12	20,0	2	140	25	AV5M12	13,0	70,73	AV5MM12	14,0	70,73	AV5GM12	10,2	70,73
M14	24,0	2	150	30	AV5M14	15,0	98,18	AV5MM14	15,5	98,18	AV5GM14	12,0	98,18
M16	26,0	3	180	35	AV5M16	17,0	115,29	AV5MM16	17,5	115,29	AV5GM16	14,0	115,29
M18	30,0	3	180	35	AV5M18	19,0	124,40	AV5MM18	20,0	124,40	AV5GM18	15,5	124,40
M20	33,0	3	190	40	AV5M20	21,0	135,54	AV5MM20	22,0	135,54	AV5GM20	17,5	135,54
M22	36,0	3	190	40	AV5M22	23,0	165,17	AV5MM22	24,0	165,17	AV5GM22	19,5	165,17
M24	40,0	3	190	40	AV5M24	25,0	199,67	AV5MM24	26,0	199,67	AV5GM24	21,0	199,67
M27	46,0	4	255	50	AV5M27	30,0	226,88						
M30	48,0	4	255	50	AV5M30	33,0	274,47						

APLICACIONES DE LOS TIPOS DE AJUSTES: FINO, MEDIO Y AGUJERO ROSCADO

- T₁: Tornillos Cabeza Cilíndrica DIN 84 y DIN 7984
Tornillos Autorroscantes DIN 7513
DIN 7500
- T₂: Tornillos Cabeza Cilíndrica DIN 6912
- T₃: Tornillos Cabeza Cilíndrica DIN 912

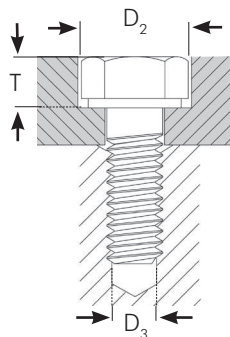

	FINO	MEDIO	AGUJERO ROSCADO	D ₂	T ₁	T ₂	T ₃
ROSCAS MÉTRICAS	D ₃ mm	D ₃ mm	D ₃ mm	mm	mm	mm	mm
M3	3,2	3,4	2,5	6,0	2,4	--	3,4
M4	4,3	4,5	3,3	8,0	3,2	3,4	4,6
M5	5,3	5,5	4,2	10,0	4,0	4,2	5,7
M6	6,4	6,6	5,0	11,0	4,7	4,8	6,8
M8	8,4	9,0	6,8	15,0	6,0	6,0	6,0
M10	10,5	11,0	8,5	18,0	7,0	7,5	11,0
M12	13,0	13,5	10,2	20,0	8,0	8,5	13,0
M14	15,0	15,5	12,0	24,0	9,0	9,5	15,0
M16	17,0	17,5	14,0	26,0	10,5	11,5	17,5
M18	19,0	20,0	15,5	30,0	11,5	12,5	19,5
M20	21,0	22,0	17,5	33,0	12,5	13,5	21,5
M22	23,0	24,0	19,5	36,0	13,5	14,5	23,5

AVELLANADORES CON ELEMENTOS INTERCAMBIABLES PARA ASIENTOS DE TORNILLOS CON CABEZA "ALLEN" Y CÓNICA

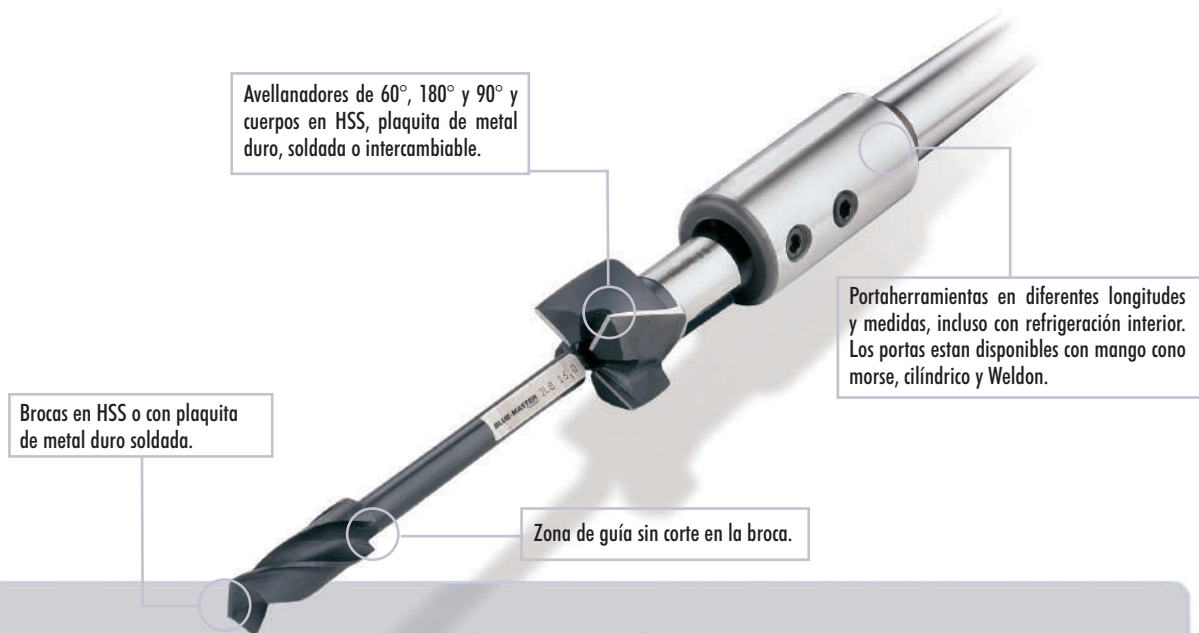

EL SISTEMA BLUEMASTER

El sistema BLUEMASTER es único para operaciones de cajeado y avellanado, ayudándole a incrementar su productividad y disminuir sus costes.

Nuestros portaherramientas, fresas, brocas y guías pueden combinarse para adaptarlos a todo tipo de máquinas y aplicaciones.

Usted puede componer fácilmente más de 1.500.000 de herramientas especiales con sólo 1.300 piezas.

El sistema consta de 3 grupos de dimensiones: **SERIE A, SERIE B y SERIE C.**

Todas las combinaciones tienen que hacerse con elementos que pertenezcan al mismo grupo. Herramientas de distintos grupos no son combinables entre sí.

En las siguientes páginas encontrará tanto los rangos de medidas disponibles en cada grupo, así como recomendaciones para la correcta elección tanto de la herramienta como de los datos de corte.

Importante!

- * Usando corte de metal duro colocar el tornillo de ajuste axial en contacto con la guía o broca insertada.
- * Dejar un espacio entre el filo y la guía o broca para prevenir roturas por impacto accidental.
- * El tornillo axial también se usa para prolongar la vida de las brocas tras reafilarlas.

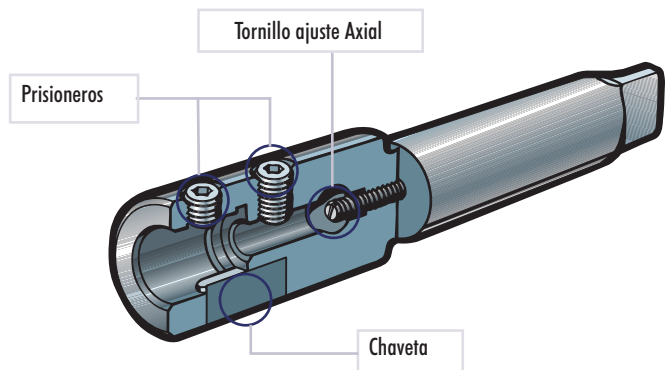

DIMENSIONES DE GUÍA, PORTA Y BROCA

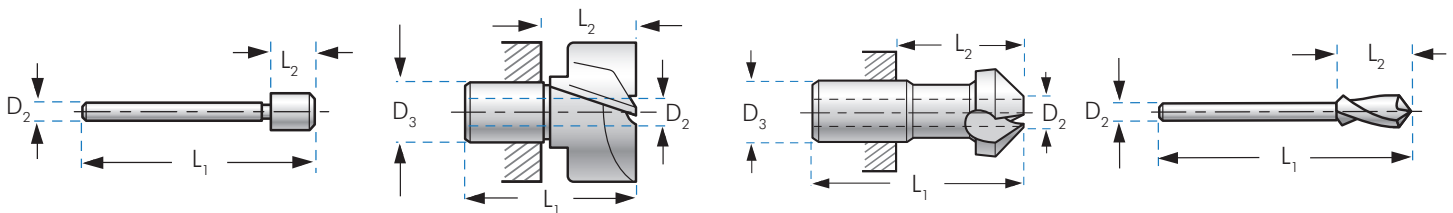

	GUÍA				PORTAS					AVELLANADOR					BROCA		
	D ₂ mm	L ₁ mm	L ₂ mm		D ₃ mm	D ₂ mm	L ₁ mm	L ₂ mm		D ₃ mm	D ₂ mm	L ₁ mm	L ₂ mm		D ₂ mm	L ₁ mm	L ₂ mm
AGP	4	64	9	APAV-MD-PQ	10	4	40	22	AVC	10	4	40	22	ABP	4	70	15
BGP	6	80	14	BPAV-MD-PQ	14	6	48	28	BVC	14	6	48	28	BBP	6	95	25
CGP	10	110	20	CPAV-MD-PQ	22	10	61	33	CVC	22	10	61	33	CBP	10	125	30

AVELLANADORES CON ELEMENTOS INTERCAMBIABLES PARA ASIENTOS DE TORNILLOS CON CABEZA "ALLEN" Y CÓNICA

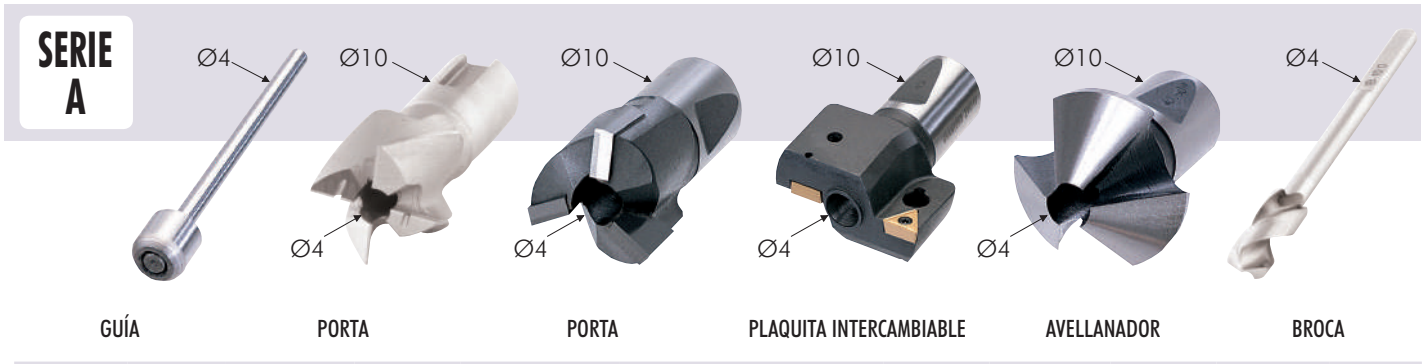

SERIE A		GUÍA		PORTA		PORTA		PLAQUITA INTERCAMBIABLE		AVELLANADOR		BROCA	
AGP		APAV		APAVMD		APAVPQ		AVC		ABP			
		HSS		MD		Plaquita no incluida PMD		90° HSS		HSS			
€		€		€		€		€		€		€	
												ABP0430	68,84
												ABP0450	68,84
												ABP0500	68,84
												ABP0530	68,84
												ABP0550	68,84
												ABP0600	80,91
												ABP0640	80,91
												ABP0650	80,91
AGP0400	39,72												
AGP0450	47,37	APAV0700	121,23										
AGP0550	47,37	APAV0800	119,76										
AGP0600	47,37	APAV0900	119,76										
AGP0650	47,37	APAV1000	115,93	APAVMD1000	340,47					AVC0800	158,00		
AGP0640	47,37												
AGP0660	47,37	APAV1100	119,76	APAVMD1100	340,47					AVC1000	158,00		
AGP0500	47,37												
		APAV1150	132,42										
		APAV1200	121,23	APAVMD1200	340,47					AVC1200	160,36	ABP0660	80,91
		APAV1250	134,47							AVC1150	155,07		
		APAV1300	132,13	APAVMD1300	340,47					AVC1240	162,22		
		APAV1350	152,13										
		APAV1400	132,13	APAVMD1400	343,69					AVC1350	162,22		
		APAV1450	152,43							AVC1400	173,90		
AGP0840	47,97												
AGP0900	47,97	APAV1500	133,60	APAVMD1500	347,52					AVC1500	175,36		
AGP0680	47,37												
AGP0700	47,37	APAV1600	141,23	APAVMD1600	355,47					AVC1600	176,25		
AGP0750	47,37	APAV1700	143,92	APAVMD1700	363,13					AVC1650	171,56		
AGP0800	47,97	APAV1800	147,70	APAVMD1800	370,75	APAVPQ1800	774,47						
AGP0850	47,97	APAV1900	157,15	APAVMD1900	387,53								
AGP0900	47,97	APAV2000	162,73	APAVMD2000	395,78	APAVPQ2000	868,06						
AGP0950	47,97	APAV2100	177,45	APAVMD2100	414,59								
AGP1000	47,97												
AGP1050	47,97												
AGP1100	47,97												
AGP1150	47,97												

ADAPTADORES



APH						
	D1 mm	D2 mm	L1 mm	L2 mm	CM Ømm	€
APHCM1	18	10	110	48	CM1	283,95
APHCM2	18	10	132	57	CM2	278,66
APH-10	18	10	92	42	Ø10	265,41

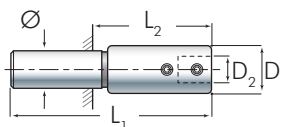
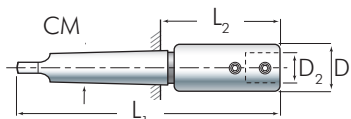

PLAQUITAS DE REPUESTO

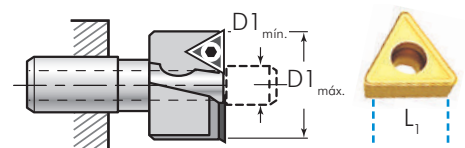

PPQ				
	L1 mm	D1 min. Ømm	D1 max. Ømm	€
PPQ07	7	18	20	29,43

**AVELLANADORES CON ELEMENTOS INTERCAMBIABLES PARA
 ASIENTOS DE TORNILLOS CON CABEZA "ALLEN" Y CÓNICA**

SERIE B		$\varnothing 6$	$\varnothing 14$	$\varnothing 14$	$\varnothing 14$	$\varnothing 14$	$\varnothing 6$	
GUÍA	PORTA	PORTA	PLAQUITA INTERCAMBIABLE	AVELLANADOR	BROCA			
BGP	BPAV	BPAVMD	BPAVPQ	BVC	BBP			
€	HSS €	MD €	Plaquita no incluida PMD €	 90° HSS €	HSS €			
	BPAV1300	134,18	BPAVMD1300	363,13				
	BPAV1350	151,53						
	BPAV1400	134,18	BPAVMD1400	363,13				
	BPAV1450	151,53					BBP0800 96,23	
BGP0840		44,73						
BGP0900	BPAV1500	134,18	BPAVMD1500	363,13		BVC15	166,55	
BGP0680		44,73						
BGP0800		44,73						
BGP1000	BPAV1550	153,60						
BGP1150	BPAV1600	141,55	BPAVMD1600	376,64			BBP0840 96,23	
BGP1250	BPAV1650	164,18					BBP0850 96,23	
BGP1350	BPAV1700	147,41	BPAVMD1700	376,64			BBP0950 96,23	
BGP1450	BPAV1750	165,35					BBP1000 109,75	
	BPAV1900	170,08	BPAVMD1900	379,90			BBP1050 109,75	
BGP1050		47,37						
BGP1100	BPAV1800	153,02	BPAVMD1800	379,90		BVC20	188,32	
BGP0850		44,73						
BGP1300		54,14						
BGP1400	BPAV2000	170,08	BPAVMD2000	391,66	BPAVPQ2000	775,12	BVC25	195,99
BGP1020		47,37						
BGP1500		54,72						
BGP1550	BPAV2400	200,99	BPAVMD2400	416,09	BPAVPQ2400	776,12	BVC28	228,04
BGP1200		47,37						
BGP1700		54,72						
BGP1750	BPAV2600	214,80	BPAVMD2600	418,44	BPAVPQ2600	889,88	BVC30	233,06
BGP1400		54,72						
BGP1900		55,90						
BGP2000	BPAV3000	290,13	BPAVMD3000	456,40	BPAVPQ3000	889,88		
	BPAV3400	343,09	BPAVMD3400	526,39	BPAVPQ3400	1.027,12		

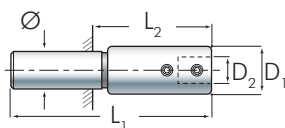
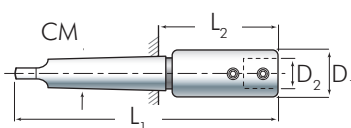
ADAPTADORES

	D1 mm	D2 mm	L1 mm	L2 mm	CM Ømm	BPH €
BPHCM1	24	14	123	62	CM1	314,87
BPHCM2	24	14	137	62	CM2	287,49
BPHCM3	24	14	160	66	CM3	314,87
BPH-12	24	14	120	55	Ø12	284,24

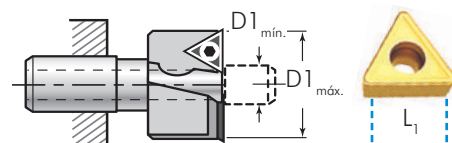
PLAQUITAS DE REPUESTO

	L1 mm	D1 min. Ømm	D1 máx. Ømm	PPQ €
PPQ07	7	20	25	29,43
PPQ10	10	26	33	26,49
PPQ12	12	34	36	26,49

AVELLANADORES CON ELEMENTOS INTERCAMBIABLES PARA ASIENTOS DE TORNILLOS CON CABEZA "ALLEN" Y CÓNICA

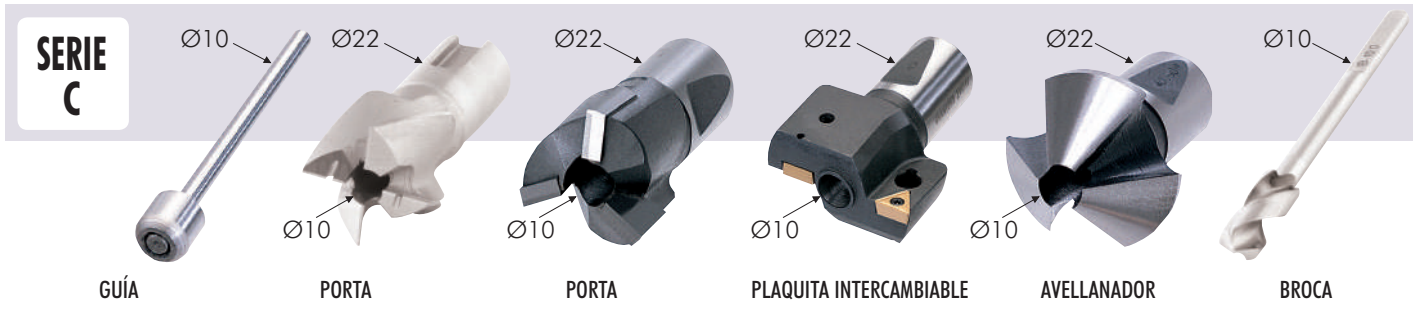

SERIE C		GUÍA		PORTA		PORTA		PLAQUITA INTERCAMBIABLE		AVELLANADOR		BROCA	
CGP		CPAV		CPAVMD		CPAVPQ		CVC		CBP			
	€	HSS	€	MD	€	Plaquita no incluida	PMD	€	90°	HSS	€	HSS	€
CGP1200	50,90	CPAV2300	243,64	CPAVMD2300	454,03								
CGP1250	50,90	CPAV2400	246,86	CPAVMD2400	449,32								
CGP1300	50,90	CPAV2500	266,90	CPAVMD2500	450,21								
CGP1350	50,90	CPAV2600	272,19	CPAVMD2600	462,57								
CGP1400	59,74	CPAV2700	276,01										
CGP1450	59,74	CPAV2800	281,31	CPAVMD2800	466,98							CBP1700	240,42
CGP1500	59,74	CPAV2900	288,07									CBP1800	271,00
CGP1600	59,74	CPAV3100	313,09									CBP1900	284,24
CGP1650	59,74	CPAV3200	323,39	CPAVMD3200	509,94							CBP2100	308,10
CGP1700	59,74	CPAV3300	326,32									CBP2300	370,75
CGP1900	59,74												
CGP2000	59,74	CPAV3000	291,89	CPAVMD3000	514,95				CVC35	339,86		CBP2000	308,10
CGP1550	59,74												
CGP2100	66,51												
CGP2200	66,51	CPAV3400	329,59	CPAVMD3400	547,32	CPAVPQ3400	1.062,16	CVC37	359,58	CBP2200	343,69		
CGP1750	59,74												
CGP1850	59,74	CPAV3500	345,17										
CGP2300	66,51												
CGP2400	66,51	CPAV3600	349,29	CPAVMD3600	562,32	CPAVPQ3600	1.062,16	CVC37	359,58	CBP2400	378,73		
CGP1950	59,74												
CGP2500	66,51												
CGP2600	81,79	CPAV4000	405,49	CPAVMD4000	622,93	CPAVPQ4000	1.086,63	CVC40	382,24				
CGP2100	66,51												
CGP2200	66,51	CPAV4500	500,24			CPAVPQ4500	1.106,47						
CGP2050	66,51	CPAV5000	726,52			CPAVPQ5000	1.294,64						
		CPAV5500	765,35			CPAVPQ5500	1.529,09						
		CPAV6000	806,54			CPAVPQ6000	1.529,09						
		CPAV6500	907,19			CPAVPQ6500	1.748,66						

ADAPTADORES



CPH						
	D1 mm	D2 mm	L1 mm	L2 mm	CM Ømm	€
CPHCM2	36	22	160	85	CM2	414,59
CPHCM3	36	22	180	87	CM3	391,66
CPHCM4	36	22	206	89	CM4	439,03
CPHCM5	36	22	240	91	CM5	966,05
CPH-12	36	22	140	71	Ø20	284,24

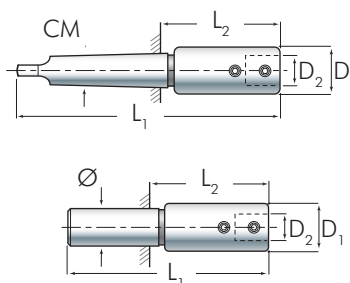

PLAQUITAS DE REPUESTO

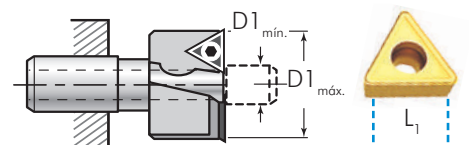

PPQ				
	L1 mm	D1 min. Ømm	D1 max. Ømm	€
PPQ12	12	34	45	26,49
PPQ17	17	<46		41,05

ESTUCHES DE AVELLANADORES
ESTUCHES DE BROCAS AVELLANADORAS PARA TUBO Y CHAPA HSS Y HSSCO
HSS

(Brocas Ref. AV30)

AV30BM0

AV30BM1

AV30BM2

REFERENCIA

AV30BM012

Nº PIEZAS

3

CALIDAD

HSS

CONTENIDO

AV30BM0 - AV30BM1 - AV30BM2
(3-14mm) (6-20mm) (16-30mm)

P.V.P. €

HSS

106,92

€ HSS

TiN

212,76

HSSCo

(Brocas Ref. AVC30)

AVC30BM0

AVC30BM1

AVC30BM2

REFERENCIA

AVC30BM012

Nº PIEZAS

3

CALIDAD

HSSCo

CONTENIDO

AVC30BM0 - AVC30BM1 - AVC30BM2
(3-14mm) (6-20mm) (16-30mm)

P.V.P. €

HSS Co

154,02

€ HSS Co

TiN

227,50

ESTUCHE DE BROCAS ESCALONADAS HELICOIDALES HSS
HSS

(Brocas Ref. AV42)

AV42BM2

AV42BM3

AV42BM4

REFERENCIA

AV42BM234

Nº PIEZAS

3

CALIDAD

HSS

CONTENIDO

AV42BM2 - AV42BM3 - AV42BM4

P.V.P. €

HSS

294,01

€ HSS

TiN

386,34



ESTUCHES DE AVELLANADORES

ESTUCHES DE BROCAS ESCALONADAS CON CANALES RECTOS HSS

HSS



AV40BM2 AV40BM3 AV40BM4 AV40BM5 AV40BM13



(Brocas Ref. AV40)



REFERENCIA	PAV40BM234	PAV40BM235	PAV40BM213
Nº PIEZAS	3	3	3
CONTENIDO	AV40BM2 - AV40BM3 - AV40BM4 (4-12mm) (4-20mm) (4-30mm)	AV40BM2 - AV40BM3 - AV40BM5 (4-12mm) (4-20mm) (6-38mm)	AV40BM2 - AV40BM3 - AV40BM13 (4-12mm) (4-20mm) (6-40mm)
P.V.P. €	172,96	215,51	257,51
€	HSS TiN	HSS TiN	HSS TiN
	296,77	337,43	404,63

(Brocas Ref. AV40)



REFERENCIA	AV40BM234	AV40BM22122
Nº PIEZAS	3	3
CONTENIDO	AV40BM2 - AV40BM3 - AV40BM4 (4-12mm) (4-20mm) (4-30mm)	AV40BM2 - AV40BM21 - AV40BM22 (4-12mm) (7+10-20mm) (10+20-30mm)
P.V.P. €	172,96	258,06
€	HSS TiN	HSS TiN
	296,77	392,13

(Brocas Ref. AVC40)

REFERENCIA	AVC40BM234
Nº PIEZAS	3
CONTENIDO	AVC40BM2 - AVC40BM3 - AVC40BM4 (4-12mm) (4-20mm) (4-30mm)
P.V.P. €	270,20
€	HSS Co TiN
	391,16

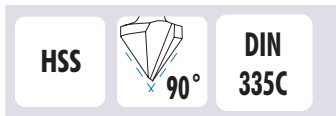
ESTUCHES DE AVELLANADORES

(Avellanadores Ref. AV6)

REFERENCIA	AV6CM1	AV6CM2	AV6CM3	PAV6CM2
Nº PIEZAS	6	6	7	6
CONTENIDO	Ø 6 - 8 - 10 - 11,5 - 15 - 19 mm	Ø 6,3 - 8,3 - 10,4 - 12,4 - 16,5 - 20,5 mm	Ø 6,3 - 8,3 - 10,4 - 12,4 - 16,5 - 20,5 - 25 mm	Ø 6,3 - 8,3 - 10,4 - 12,4 - 16,5 - 20,5 mm
P.V.P. €	143,43	125,64	211,46	125,64



(Avellanadores Ref. AV7)

REFERENCIA	AV7CM1	AV7CM2	AV7CM3	PAV7CM2
Nº PIEZAS	6	6	7	6
CONTENIDO	Ø 6 - 8 - 10 - 11,5 - 15 - 19 mm	Ø 6,3 - 8,3 - 10,4 - 12,4 - 16,5 - 20,5 mm	Ø 6,3 - 8,3 - 10,4 - 12,4 - 16,5 - 20,5 - 25 mm	Ø 6,3 - 8,3 - 10,4 - 12,4 - 16,5 - 20,5 mm
P.V.P. €	150,42	150,04	230,23	150,04

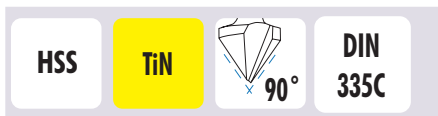

(Avellanadores Ref. AV16)

REFERENCIA	AV16CM1	AV16CM2	AV16CM3
Nº PIEZAS	6	6	7
CONTENIDO	Ø 6 - 8 - 10 - 11,5 - 15 - 19 mm	Ø 6,3 - 8,3 - 10,4 - 12,4 - 16,5 - 20,5 mm	Ø 6,3 - 8,3 - 10,4 - 12,4 - 16,5 - 20,5 - 25 mm
P.V.P. €	261,91	267,37	373,18



(Avellanadores Ref. AV8)

REFERENCIA	AV8CM2	AV8CM3
Nº PIEZAS	6	7
CONTENIDO	Ø 6,3 - 8 - 10 - 12,5 - 16 - 20 mm	Ø 6,3 - 8 - 10 - 12,5 - 16 - 20 - 25 mm
P.V.P. €	195,49	252,73

* Otros estuches bajo demanda AV99, etc.

ESTUCHES METÁLICOS DE AVELLANADORES

HSS  **NORMA CELESA**



(Avellanadores Ref. AV9)

REFERENCIA	AV9CM1	AV9CM5
Nº PIEZAS	6	7
CONTENIDO	Ø 6,3 - 8,3 - 10,4 - 12,4 - 16,5 - 20,5 mm	Ø 6,3 - 8,3 - 10,4 - 12,4 - 16,5 - 20,5 - 25 mm
P.V.P. €	199,94	258,74



HSS  **NORMA CELESA**



(Avellanadores Ref. AV10)

REFERENCIA	AV10CM1	AV10CM6
Nº PIEZAS	6	7
CONTENIDO	Ø 6,3 - 8,3 - 10,4 - 12,4 - 16,5 - 20,5 mm	Ø 6,3 - 8,3 - 10,4 - 12,4 - 16,5 - 20,5 - 25 mm
P.V.P. €	224,94	278,44



* Otros estuches bajo demanda AV99, etc.

ESTUCHES DE AVELLANADORES PARA DESBARBAR CON AGUJERO DE 90º HSS Y HSSCO

 **90º**

HSS

HSSCo

(Avellanadores Ref. AV1)

(Avellanadores Ref. AV2)

REFERENCIA	AV1S2*
Nº PIEZAS	5
CONTENIDO	Ø 10 - 14 - 20 - 27 - 30 mm
P.V.P. €	282,90*
€ HSS	404,21*

REFERENCIA	AV2S2*
Nº PIEZAS	5
CONTENIDO	Ø 10 - 14 - 20 - 27 - 30 mm
P.V.P. €	356,08*
€ HSS Co	498,52*

*Hasta fin de existencias

ESTUCHES DE AVELLANADORES PARA ASIENTOS DE TORNILLOS "ALLEN" AJUSTE FINO, MEDIO Y AGUJERO ROSCADO

HSS **DIN 373**

FINO

MEDIO

AGUJERO ROSCADO

(Avellanadores Ref. AV2M)

(Avellanadores Ref. AV2MM)

(Avellanadores Ref. AV2GM)

REFERENCIA	AV2M3-10	AV2M3-10M	AV2M3-10G
Nº PIEZAS	6		
CONTENIDO	M3 - M4 - M5 - M6 - M8 - M10		
P.V.P. €	168,87	182,82	182,82

REFERENCIA	AV2M3-12	AV2M3-12M	AV2M3-12G
Nº PIEZAS	7		
CONTENIDO	M3 - M4 - M5 - M6 - M8 - M10 - M12		
P.V.P. €	216,88	234,78	234,78



Ref. AV2M3-10

REBARBADORES DE PRECISIÓN

LOS REBARBADORES BLUEMASTER

Los rebarbadores BLUEMASTER se emplean para eliminar las virutas acumuladas en bordes y aristas de piezas fabricadas en metal, plástico o madera. El sistema se completa ensamblando los tres componentes señalados: CUCHILLA + PORTACUCHILLAS + MANGO UNIVERSAL. El mango puede ser utilizado con todos los grupos de cuchillas, intercambiando oportunamente el portacuchillas para cada uno de ellos.

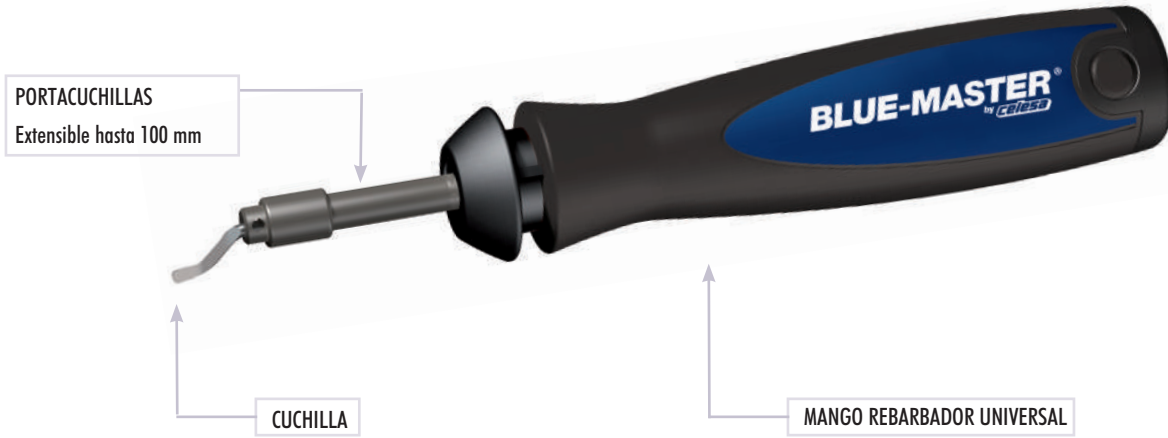

CONJUNTO B

JRB1

Contenido B:

Ref. RB10

Ref. RB20



Ref. RBB1

Ref. RBB

Blister: 30,23 €

CONJUNTO C

JRB2

Contenido C:

Ref. RC42

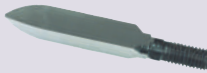

Ref. RBB1

Ref. RBC

Blister: 55,06 €

CONJUNTO D

JRB3

Contenido D:

Ref. RD80MD



Ref. RBB1

Ref. RBD

Blister: 86,79 €

CONJUNTO E

JRB4

Contenido E:

Ref. RE10

Ref. RE20

Ref. RE30



Ref. RBB1

Ref. RBE

Blister: 33,67 €



REBARBADORES DE PRECIÓN

GRUPO B

PORTACUCHILLAS GRUPO B



Para cuchillas rebarbadoras Grupo B

RBB
10,61 €

CUCHILLAS GRUPO B



Cuchilla rebarbadora
Serie corta: acero, aluminio, plástico

RB10*

Blister 10 U.: 1,96€/U.



Cuchilla punzonadora de Metal Duro

RB50*

Blister 1 U.: 34,93 €



Cuchilla rebarbadora Bidireccional Serie corta:
latón, fundición

RB20

Blister 10 U.: 1,96 €/U.



Cuchilla rebarbadora
para parte posterior de un taladro de hasta
20 mm de profundidad

RB60*

Blister 10 U.: 4,64 €/Ud



Cuchilla rebarbadora doble arista agujeros de
4 mm de profundidad

RB30

Blister 10 U.: 1,96 €/Ud



Cuchilla
rebarbadora de aristas exteriores

RB70MD*

Blister 1 U.: 39,73 €

*Hasta fin de existencia

GRUPO C

PORTACUCHILLAS GRUPO C



Para cuchillas rebarbadoras Grupo C

RBC
Blister 1U.: 10,61 €

CUCHILLAS GRUPO C



Cuchilla rasqueta ancho 4 x 20 mm

RC40*

Blister 1 U.: 21,63 €



Cuchilla rasqueta ancho 8 x 30 mm

RC42*

Blister 1 U.: 26,91 €

*Hasta fin de existencia

GRUPO D

PORTACUCHILLAS GRUPO D



Para cuchillas rebarbadoras Grupo D

RBD
Blister 1 U.: 10,61 €

CUCHILLAS GRUPO D



Cuchilla rebarbadora de metal duro
en "V" Hembra cantos hasta 3 mm

RD80MD*

Blister 1 U.: 56,55 €



Cuchilla rebarbadora de Metal Duro
en "V" Hembra cantos hasta 8 mm

RD82MD*

Blister 1 U.: 88,65 €

*Hasta fin de existencia

MANGO REBARBADOR UNIVERSAL

Usos generales.
 Válido para portacuchillas:
 Ref. RBB / RBC / RBD / RBE / RBF

RBB1

Blister 1 ud.: 13,94 €

REBARBADORES DE PRECISIÓN
GRUPO E
PORTACUCHILLAS GRUPO E

Para cuchillas rebarbadoras Grupo E

RBE

Blister 1 ud.: 10,61 €

CUCHILLAS GRUPO E

Cuchilla rebarbadora
 para interiores y exteriores
 Serie larga: acero, aluminio, plástico

RE10

Blister 10 ud.: 2,40 €/Ud



Cuchilla rebarbadora
 para cantos rectos: chaveteros,...

RE35

Blister 10 ud.: 2,57 €/Ud



Cuchilla rebarbadora bidireccional
 Serie larga: latón, fundición

RE20

Blister 10 ud.: 2,40 €/Ud



Cuchilla rebarbadora
 cerrada doble arista para
 agujeros de 4 mm de profundidad

RE30

Blister 10 ud.: 2,40 €/Ud



Cuchilla rebarbadora para la parte
 posterior de un taladro de hasta
 20 mm de profundidad

RE60*

Blister 5 ud.: 3,37 €/Ud

*Hasta fin de existencia

GRUPO F
PORTACUCHILLAS GRUPO F

Para cuchillas rebarbadoras Grupo F

RBF

Blister 1 ud.: 10,61 €

CUCHILLAS GRUPO F (Rosca M05 x 0,80)

Cuchilla avellanadora HSS Ø 12 mm

RF12

Blister 1 ud.: 23,87 €



Cuchilla avellanadora HSS Ø 30 mm

RF30

Blister 1 ud.: 79,76 €



Cuchilla avellanadora HSS Ø 20 mm

RF20

Blister 1 ud.: 46,14 €