



# CATÁLOGO



MADE IN SPAIN

Situada en Aretxabaleta. Dentro de la comarca guipuzcoana del Alto Deba. Un núcleo industrial referente con una destacada experiencia en innovación de producto y perfectamente comunicada con el resto de la península y Europa.



# experiencia y futuro

Más de 80 años en el mundo de la cerrajería nos proporcionan un control del medio, de las redes de distribución y de las necesidades del cliente. Pero sobre todo nos ha permitido entender que era el momento de dar un paso hacia adelante.

## ÍNDICE POR REFERENCIA

REF.	PÁG.	REF.	PÁG.	REF.	PÁG.	REF.	PÁG.
1122A70D/0	104	122A70D/1	104	156B60I/0	99	194/30/6ANSC	43
1122A70D/1	104	122A70I/0	104	156B60I/1	99	194/30/6SC	43
1122A70I/0	104	122A70I/1	104	156BR70D/0	99	194/30/6USC	43
1122A70I/1	104	122C70D/0	105	156BR70D/1	99	194/35/6ANSC	43
1122C70D/0	105	122C70D/1	105	156BR70I/0	99	194/35/6SC	43
1122C70D/1	105	122C70I/0	105	156BR70I/1	99	194/35/6USC	43
1122C70I/0	105	122C70I/1	105	156C60D/0	100	194F/30/6SC	32
1122C70I/1	105	123A10D/0	106	156C60D/1	100	194F/35/6SC	32
1123A10D/0	106	123A10D/1	106	156C60I/0	100	194RV25/6ANSC	43
1123A10D/1	106	123A10I/0	106	156C60I/1	100	194RV25/6SC	43
1123A10I/0	106	123A10I/1	106	156C70D/0	100	194RV25/6USC	43
1123A10I/1	106	123A12D/0	106	156C70D/1	100	194RV30/6ANSC	43
1123A12D/0	106	123A12D/1	106	156C70I/0	100	194RV30/6SC	43
1123A12D/1	106	123A12I/0	106	156C70I/1	100	194RV30/6USC	43
1123A12I/0	106	123A12I/1	106	184/21/0	33	194RV35/6ANSC	43
1123A12I/1	106	123C10D/0	107	184/21/6D	33	194RV35/6SC	43
1123C10D/0	107	123C10D/1	107	184/23/0	33	194RV35/6USC	43
1123C10D/1	107	123C10I/0	107	184/23/6	33	196/25/6	37
1123C10I/0	107	123C10I/1	107	184/25/0	33	196/25/6AN	37
1123C10I/1	107	123C12D/0	107	184/25/6	33	196/28/6	37
1123C12D/0	107	123C12D/1	107	184/28/0	33	196/28/6AN	37
1123C12D/1	107	123C12I/0	107	184/28/6	33	196/30/6	37
1123C12I/0	107	123C12I/1	107	184/30/0	33	196/30/6AN	37
1123C12I/1	107	124A10D/0	103	184/30/6	33	196/33/6	37
1124A10D/0	103	124A10D/1	103	184/33/0	33	196/33/6AN	37
1124A10D/1	103	124A10I/0	103	184/33/6	33	196/35/6	37
1124A10I/0	103	124A10I/1	103	184/35/0	33	196/35/6AN	37
1124A10I/1	103	124A12D/0	103	184/35/6	33	196/38/6	37
1124A12D/0	103	124A12D/1	103	184A23/6	33	196/38/6AN	37
1124A12D/1	103	124A12I/0	103	184A25/6	33	1960/60/2	119
1124A12I/0	103	124A12I/1	103	184A28/6	33	1960/60/6	119
1124A12I/1	103	124A14D/0	103	184A30/6	33	1960/70/2	119
1124A14D/0	103	124A14D/1	103	184A33/6	33	1960/70/6	119
1124A14D/1	103	124A14I/0	103	184A35/6	33	1960A60/2	119
1124A14I/0	103	124A14I/1	103	184V23/6	34	1960A60/6	119
1124A14I/1	103	124A8D/0	103	184V25/6	34	1960A70/2	119
1124A8D/0	103	124A8D/1	103	184V28/6	34	1960A70/6	119
1124A8D/1	103	124A8I/0	103	184V30/6	34	1960T60/2	119
1124A8I/0	103	124A8I/1	103	184V33/6	34	1960T60/6	119
1124A8I/1	103	125A12D/0	101	184V35/6	34	1960T70/2	119
1125A12D/0	101	125A12D/1	101	190/23/0	69	1960T70/6	119
1125A12D/1	101	125A12I/0	101	190/23/5	69	1961/60/2	120
1125A12I/0	101	125A12I/1	101	190/23/6	69	1961/70/2	120
1125A12I/1	101	125A14D/0	101	190/28/0	69	1961A60/2	120
1125A14D/0	101	125A14D/1	101	190/28/5	69	1961A70/2	120
1125A14D/1	101	125A14I/0	101	190/28/6	69	1962/60/2	121
1125A14I/0	101	125A14I/1	101	190/33/0	69	1962/70/2	121
1125A14I/1	101	125A8D/0	101	190/33/5	69	1962A60/2	121
1125A8D/0	101	125A8D/1	101	190/33/6	69	1962A70/2	121
1125A8D/1	101	125A8I/0	101	190A23/0	69	1962T60/2	121
1125A8I/0	101	125A8I/1	101	190A23/5	69	1962T70/2	121
1125A8I/1	101	125AR10D/0	101	190A23/6	69	1963/0	80
1125AR10D/0	101	125AR10D/1	101	190A28/0	69	1963/5	80
1125AR10D/1	101	125AR10I/0	101	190A28/5	69	1963/6	80
1125AR10I/0	101	125AR10I/1	101	190A28/6	69	1963A/0	80
1125AR10I/1	101	125BR12D/0	102	190A33/0	69	1963A/5	80
1125BR12D/0	102	125BR12D/1	102	190A33/5	69	1963A/6	80
1125BR12D/1	102	125BR12I/0	102	190A33/6	69	1963C/6	80
1125BR12I/0	102	125BR12I/1	102	192/25/6ANSC	40	1963CP16/6	81
1125BR12I/1	102	125BR14D/0	102	192/25/6SC	40	1963R/0	81
1125BR14D/0	102	125BR14D/1	102	192/30/6ANSC	40	1963RV/0	81
1125BR14D/1	102	125BR14I/0	102	192/30/6SC	40	1963V/0	81
1125BR14I/0	102	125BR14I/1	102	192/35/6ANSC	40	1963V/5	81
1125BR14I/1	102	156A60D/0	98	192/35/6SC	40	1963V/6	81
11981/60/0	85	156A60D/1	98	192V25/6ANSC	40	1964/0	83
11981/60/5	85	156A60I/0	98	192V25/6SC	40	1964/5	83
11981V60/0	85	156A60I/1	98	192V30/6ANSC	40	1964/6	83
11981V60/5	85	156A70D/0	98	192V30/6SC	40	1964A/0	83
11A	90	156A70D/1	98	192V35/6ANSC	40	1964A/5	83
11A/3P	90	156A70I/0	98	192V35/6SC	40	1964C/0	83
11B	91	156A70I/1	98	194/25/6ANSC	43	1964C/6	83
11B/M	91	156B60D/0	99	194/25/6SC	43	1964CP/6	83
122A70D/0	104	156B60D/1	99	194/25/6USC	43	1964R/0	84

**ÍNDICE POR REFERENCIA**

REF.	PÁG.	REF.	PÁG.	REF.	PÁG.	REF.	PÁG.
1964RV/0	84	1978/1	109	1990/25/0	70	1E2NV/50/6	19
1964T/0	84	1979/0	89	1990/25/5	70	1E2NV/50/6AN	19
1964T/5	84	1979/5	89	1990/25/6	70	1E5/30/6	22
1964T/6	84	1979P/0	89	1990/32/0	70	1E5/30/6AN	22
1964V/0	84	1979P/5	89	1990/32/5	70	1E5/35/6	22
1964V/5	84	197KBN25/6U16	61	1990/32/6	70	1E5/35/6AN	22
1964V/6	84	1981/60/0	85	1990A20/0	70	1E5/40/6	22
1968/0	87	1981/60/5	85	1990A20/5	70	1E5/40/6AN	22
1968/5	87	1981V60/0	85	1990A20/6	70	1E5/50/6	22
196A25/6	37	1981V60/5	85	1990A25/0	70	1E5/50/6AN	22
196A28/6	37	1982/0	88	1990A25/5	70	1E5NV/30/6	23
196A30/6	37	1982/5	88	1990A25/6	70	1E5NV/30/6AN	23
196A33/6	37	1983/20/0	78	1990A32/0	70	1E5NV/35/6	23
196A35/6	37	1983/20/5	78	1990A32/5	70	1E5NV/35/6AN	23
196A38/6	37	1983/20/6	78	1990A32/6	70	1E5NV/40/6	23
196R23/6	38	1983/25/0	78	1990V20/0	70	1E5NV/40/6AN	23
196R25/6	38	1983/25/5	78	1990V20/5	70	1E5NV/50/6	23
196R28/6	38	1983/25/6	78	1990V20/6	70	1E5NV/50/6AN	23
196R30/6	38	1983/30/0	78	1990V25/0	70	1I5K25/6U16	59
196R33/6	38	1983/30/5	78	1990V25/5	70	1K5/30/6	25
196R35/6	38	1983/30/6	78	1990V25/6	70	1K5/33/6	25
196R38/6	38	1983A20/0	78	1990V32/0	70	1K5/35/6	25
196RV/6	38	1983A20/5	78	1990V32/5	70	1K5T30/6	25
196T23/6	38	1983A25/0	78	1990V32/6	70	1K5T33/6	25
196T25/6	38	1983A25/5	78	1991/60/0	86	1K5T35/6	25
196T28/6	38	1983A30/0	78	1991/60/5	86	1T8KD20/6L17B	63
196T30/6	38	1983A30/5	78	1991/70/0	86	1T8KD20/6L17N	63
196T33/6	38	1983R20/0	78	1991/70/5	86	1T8KD20/6LB	63
196T35/6	38	1983R25/0	78	1992/20/6	77	1T8KD20/6LN	63
196T38/6	38	1983R30/0	78	1992/25/6	77	234/50/1	111
196V25/6	38	1983RV/0	79	1992/30/6	77	234/60/1	111
196V28/6	38	1983T20/6	79	1992T20/6	77	234/70/1	111
196V30/6	38	1983T25/6	79	1992T25/6	77	236/50/1	112
196V33/6	38	1983T30/6	79	1992T30/6	77	236/60/1	112
196V35/6	38	1984/20/0	66	1994/25/6L	71	236/70/1	112
196V38/6	38	1984/20/5	66	1994/25/6U	71	249B50/2	122
197/25/6	39	1984/20/6	66	1994/30/6L	71	249B60/2	122
197/28/6	39	1984/25/0	66	1994/30/6U	71	249B70/2	122
197/30/6	39	1984/25/5	66	1994/35/6L	71	249R50/2	122
197/33/6	39	1984/25/6	66	1994/35/6U	71	249R60/2	122
197/35/6	39	1984/30/0	66	1994A25/6L	72	249R70/2	122
197/38/6	39	1984/30/5	66	1994A25/6U	72	294N/30/6L	41
1970N/40/2	117	1984/30/6	66	1994A30/6L	72	294N/30/6LAN	41
1970N/40/6	117	1984T20/6	66	1994A30/6U	72	294N/30/6U	41
1970N/50/2	117	1984T25/6	66	1994A35/6L	72	294N/35/6L	41
1970N/50/6	117	1984T30/6	66	1994A35/6U	72	294N/35/6LAN	41
1970N/60/2	117	1984V20/6	66	1994V25/6L	72	294N/35/6U	41
1970N/60/6	117	1984V25/6	66	1994V25/6U	72	294NV30/6L	42
1970NA40/2	117	1984V30/6	66	1994V30/6L	72	294NV30/6LAN	42
1970NA40/6	117	1985N/40/2	116	1994V30/6U	72	294NV30/6U	42
1970NA50/2	117	1985N/40/6	116	1994V35/6L	72	294NV35/6L	42
1970NA50/6	117	1985N/50/2	116	1994V35/6U	72	294NV35/6LAN	42
1970NA60/2	117	1985N/50/6	116	1995/32/0	67	294NV35/6U	42
1970NA60/6	117	1985N/60/2	116	1995/32/5	67	296/25/6L	35
1970NT40/2	117	1985N/60/6	116	1995/32/6	67	296/25/6LAN	35
1970NT40/6	117	1985NT40/2	116	1995A32/6	67	296/25/6U	35
1970NT50/2	117	1985NT40/6	116	1995R32/0	67	296/28/6L	35
1970NT50/6	117	1985NT50/2	116	1995T32/6	68	296/28/6LAN	35
1970NT60/2	117	1985NT50/6	116	1995V32/6	68	296/28/6U	35
1970NT60/6	117	1985NT60/2	116	1E2/30/6	18	296/30/6L	35
1970NV40/6	118	1985NT60/6	116	1E2/30/6AN	18	296/30/6LAN	35
1970NV50/6	118	1988/0	110	1E2/35/6	18	296/30/6U	35
1970NV60/6	118	1988/1	110	1E2/35/6AN	18	296/33/6L	35
1975/0	82	198K25/6	62	1E2/40/6	18	296/33/6LAN	35
1975/5	82	198K30/6	62	1E2/40/6AN	18	296/33/6U	35
1975A/0	82	198K35/6	62	1E2/50/6	18	296/35/6L	35
1975A/5	82	198KB25/6	62	1E2/50/6AN	18	296/35/6LAN	35
1975T/0	82	198KB30/6	62	1E2NV/30/6	19	296/35/6U	35
1975T/5	82	198KB35/6	62	1E2NV/30/6AN	19	296/38/6L	35
1975V/0	82	198KD20/6	62	1E2NV/35/6	19	296/38/6LAN	35
1975V/5	82	1990/20/0	70	1E2NV/35/6AN	19	296A25/6L	36
1976/1	108	1990/20/5	70	1E2NV/40/6	19	296A25/6LAN	36
1978/0	109	1990/20/6	70	1E2NV/40/6AN	19	296A25/6U	36

## ÍNDICE POR REFERENCIA

REF.	PÁG.	REF.	PÁG.	REF.	PÁG.	REF.	PÁG.
296A28/6L	36	2E2GB35/6L	15	3994/35/6U	75	5181/3030/4	143
296A28/6LAN	36	2E2GB35/6LAN	15	3994A25/6L	75	5500/1N	152
296A30/6L	36	2E2GB35/6U	15	3994A25/6U	75	5500/1NM	152
296A30/6LAN	36	2E2GB40/6L	15	3994A30/6L	75	5500/6	152
296A30/6U	36	2E2GB40/6LAN	15	3994A30/6U	75	56A60D/0	98
296A33/6L	36	2E2GB40/6U	15	3994A35/6L	75	56A60D/1	98
296A33/6LAN	36	2E2GB50/6L	15	3994A35/6U	75	56A60L/0	98
296A35/6L	36	2E2GB50/6LAN	15	3994F25/6L	76	56A60I/1	98
296A35/6LAN	36	2E2GB50/6U	15	3994F25/6U	76	56A70D/0	98
296A35/6U	36	2E2NV/30/6L	17	3994F30/6L	76	56A70D/1	98
296A38/6L	36	2E2NV/30/6LAN	17	3994F30/6U	76	56A70I/0	98
296A38/6LAN	36	2E2NV/30/6U	17	3994F35/6L	76	56A70I/1	98
296V25/6L	36	2E2NV/35/6L	17	3994F35/6U	76	56B60D/0	99
296V25/6LAN	36	2E2NV/35/6LAN	17	3994V25/6L	76	56B60D/1	99
296V25/6U	36	2E2NV/35/6U	17	3994V25/6U	76	56B60L/0	99
296V28/6L	36	2E2NV/40/6L	17	3994V30/6L	76	56B60I/1	99
296V28/6LAN	36	2E2NV/40/6LAN	17	3994V30/6U	76	56BR70D/0	99
296V30/6L	36	2E2NV/40/6U	17	3994V35/6L	76	56BR70D/1	99
296V30/6LAN	36	2E2NV/50/6L	17	3994V35/6U	76	56BR70I/0	99
296V30/6U	36	2E2NV/50/6LAN	17	3I2/30/6L	29	56BR70I/1	99
296V33/6L	36	2E2NV/50/6U	17	3I2/33/6L	29	56C60D/0	100
296V33/6LAN	36	2E5/30/6L	20	3I2/35/6L	29	56C60D/1	100
296V35/6L	36	2E5/30/6LAN	20	3I5/30/6L	29	56C60I/0	100
296V35/6LAN	36	2E5/30/6U	20	3I5/33/6L	29	56C60I/1	100
296V35/6U	36	2E5/35/6L	20	3I5/35/6L	29	56C70D/0	100
296V38/6L	36	2E5/35/6LAN	20	400/50/6HP	156	56C70D/1	100
296V38/6LAN	36	2E5/35/6U	20	400/60/6HP	156	56C70I/0	100
297KN25/6U16	60	2E5/40/6L	20	4000/50/0	114	56C70I/1	100
2994/25/6L	73	2E5/40/6LAN	20	4000/50/6	114	582PM2505/3	131
2994/25/6U	73	2E5/40/6U	20	4000/60/0	114	582PM2505/4	131
2994/30/6L	73	2E5/50/6L	20	4000/60/6	114	582PM2525/3	130
2994/30/6U	73	2E5/50/6LAN	20	4000A50/0	114	582PM2525/4	130
2994/35/6L	73	2E5/50/6U	20	4000A50/6	114	582PM2530/3	130
2994/35/6U	73	2E5NV/30/6L	21	4000A60/0	114	582PM2530/4	130
2994A25/6L	74	2E5NV/30/6LAN	21	4000A60/6	114	582PM2535/3	130
2994A25/6U	74	2E5NV/30/6U	21	4001/50/0	114	582PM2535/4	130
2994A30/6L	74	2E5NV/35/6L	21	4001/50/6	114	582PM2540/3	130
2994A30/6U	74	2E5NV/35/6LAN	21	4001/60/0	114	582PM2540/4	130
2994A35/6L	74	2E5NV/35/6U	21	4001/60/6	114	582PM2545/3	130
2994A35/6U	74	2E5NV/40/6L	21	4001A50/0	114	582PM2545/4	130
2994V25/6L	74	2E5NV/40/6LAN	21	4001A50/6	114	582PM2550/3	130
2994V25/6U	74	2E5NV/40/6U	21	4001A60/0	114	582PM2550/4	130
2994V30/6L	74	2E5NV/50/6L	21	4001A60/6	114	582PM2555/3	130
2994V30/6U	74	2E5NV/50/6LAN	21	400L60/6HP	156	582PM2555/4	130
2994V35/6L	74	2E5NV/50/6U	21	400LT60/6H	157	582PM2560/3	130
2994V35/6U	74	2I2/30/6L	28	400T50/6H	157	582PM2560/4	130
2A2/30/6L	13	2I2/30/6LAN	28	400T60/6H	157	582PM2565/3	130
2A2/30/6LAN	13	2I2/30/6U	28	410/50/6HP	160	582PM2565/4	130
2A2/30/6U	13	2I2/33/6L	28	410/50D/6HP	159	582PM25T25/3	131
2A2/35/6L	13	2I2/33/6LAN	28	410/50I/6HP	159	582PM25T25/4	131
2A2/35/6LAN	13	2I2/33/6U	28	410/60/6HP	160	582PM3005/3	131
2A2/35/6U	13	2I2/35/6L	28	410/60D/6HP	159	582PM3005/4	131
2A2/45/6L	13	2I2/35/6LAN	28	410/60I/6HP	159	582PM3030/3	130
2A2/45/6LAN	13	2I2/35/6U	28	4100/50/0	115	582PM3030/4	130
2A2/45/6U	13	2I2GB30/6L	27	4100/60/0	115	582PM3045/3	130
2A2M30/6L	11	2I2GB30/6LAN	27	410L60/6HP	159	582PM3045/4	130
2A2M35/6L	11	2I2GB30/6U	27	410L60D/6HP	158	582PM30T30/3	131
2A2M45/6L	11	2I2GB33/6L	27	410L60I/6HP	158	582PM30T30/4	131
2E2/30/6L	16	2I2GB33/6LAN	27	4E25/30/6L	14	582PM30T45/3	131
2E2/30/6LAN	16	2I2GB33/6U	27	4E25/35/6L	14	582PM30T45/4	131
2E2/30/6U	16	2I2GB35/6L	27	4E25/40/6L	14	582PM3505/3	131
2E2/35/6L	16	2I2GB35/6LAN	27	4E25/50/6L	14	582PM3505/4	131
2E2/35/6LAN	16	2I2GB35/6U	27	4I25/30/6L	26	582PM3525/3	130
2E2/35/6U	16	2I5K25/6U16	58	4I25/33/6L	26	582PM3525/4	130
2E2/40/6L	16	2I5K825/6U16	58	4I25/35/6L	26	582PM3535/3	130
2E2/40/6LAN	16	2K5/30/6L	24	4I54K256U16	57	582PM3535/4	130
2E2/40/6U	16	2K5/33/6L	24	4I54K8256U16	57	582PM3540/3	130
2E2/50/6L	16	2K5/35/6L	24	5000/1N	151	582PM3540/4	130
2E2/50/6LAN	16	3994/25/6L	75	5000/1NM	151	582PM3545/3	130
2E2/50/6U	16	3994/25/6U	75	5000/6	151	582PM3545/4	130
2E2GB30/6L	15	3994/30/6L	75	5081/3030/3	143	582PM35T25/3	131
2E2GB30/6LAN	15	3994/30/6U	75	5081/3030/4	143	582PM35T25/4	131
2E2GB30/6U	15	3994/35/6L	75	5181/3030/3	143	582PM35T35/3	131

## ÍNDICE POR REFERENCIA

REF.	PÁG.	REF.	PÁG.	REF.	PÁG.	REF.	PÁG.
582PM35T35/4	131	5963/2222/4	142	5982/3045/3	128	5982T70/4	130
582PM4005/3	131	5963/2525/3	142	5982/3045/4	128	5990/2525/3	132
582PM4005/4	131	5963/2525/4	142	5982/3050/3	128	5990/2525/4	132
582PM4505/3	131	5963/3030/3	142	5982/3050/4	128	5990/2530/3	132
582PM4505/4	131	5963/3030/4	142	5982/3055/3	128	5990/2530/4	132
582PM5005/3	131	5963/3535/3	142	5982/3055/4	128	5990/2535/3	132
582PM5005/4	131	5963/3535/4	142	5982/3060/3	128	5990/2535/4	132
582PM5505/3	131	5963/4040/3	142	5982/3060/4	128	5990/2540/3	132
582PM5505/4	131	5963/4040/4	142	5982/3080/3	129	5990/2540/4	132
590PM2505/3	135	5963T36/3	142	5982/3080/4	129	5990/2545/3	132
590PM2505/4	135	5963T36/4	142	5982/3535/3	128	5990/2545/4	132
590PM2525/3	134	5964/2525/3	146	5982/3535/4	128	5990/2550/3	132
590PM2525/4	134	5964/2525/4	146	5982/3540/3	128	5990/2550/4	132
590PM2530/3	134	5964/3030/3	146	5982/3540/4	128	5990/2555/3	132
590PM2530/4	134	5964/3030/4	146	5982/3545/3	128	5990/2555/4	132
590PM2535/3	134	5964/4040/3	146	5982/3545/4	128	5990/2560/3	132
590PM2535/4	134	5964/4040/4	146	5982/3555/3	128	5990/2560/4	132
590PM2540/3	134	5964P3030/3	146	5982/3555/4	128	5990/2565/3	132
590PM2540/4	134	5964P3030/4	146	5982/3565/3	129	5990/2565/4	132
590PM2545/3	134	5964T25/3	146	5982/3565/4	129	5990/2575/3	133
590PM2545/4	134	5964T25/4	146	5982/3575/3	129	5990/2575/4	133
590PM2550/3	134	5964T30/3	146	5982/3575/4	129	5990/2585/3	133
590PM2550/4	134	5964T30/4	146	5982/3595/3	129	5990/2585/4	133
590PM2555/3	134	5964T40/3	146	5982/3595/4	129	5990/2595/3	133
590PM2555/4	134	5964T40/4	146	5982/4040/3	128	5990/2595/4	133
590PM2560/3	134	5968/2525/3	147	5982/4040/4	128	5990/3030/3	132
590PM2560/4	134	5968/2525/4	147	5982/4050/3	129	5990/3030/4	132
590PM2565/3	134	5968/3030/3	147	5982/4050/4	129	5990/3035/3	132
590PM2565/4	134	5968/3030/4	147	5982/4055/3	129	5990/3035/4	132
590PM25T25/3	135	5968/4040/3	147	5982/4055/4	129	5990/3040/3	132
590PM25T25/4	135	5968/4040/4	147	5982/4060/3	129	5990/3040/4	132
590PM3005/3	135	5968P3030/3	147	5982/4060/4	129	5990/3045/3	132
590PM3005/4	135	5968P3030/4	147	5982/4070/3	129	5990/3045/4	132
590PM3030/3	134	5968T25/3	147	5982/4070/4	129	5990/3050/3	132
590PM3030/4	134	5968T25/4	147	5982/4080/3	129	5990/3050/4	132
590PM3045/3	134	5968T30/3	147	5982/4080/4	129	5990/3055/3	132
590PM3045/4	134	5968T30/4	147	5982/4545/3	129	5990/3055/4	132
590PM30T30/3	135	5968T40/3	147	5982/4545/4	129	5990/3060/3	133
590PM30T30/4	135	5968T40/4	147	5982/4555/3	129	5990/3060/4	133
590PM30T45/3	135	5979/3030/3	148	5982/4555/4	129	5990/3080/3	133
590PM30T45/4	135	5979/3030/4	148	5982/5050/3	129	5990/3080/4	133
590PM3505/3	135	5979P3030/3	148	5982/5050/4	129	5990/3535/3	132
590PM3505/4	135	5979P3030/4	148	5982/5555/3	129	5990/3535/4	132
590PM3525/3	134	5982/2525/3	128	5982/5555/4	129	5990/3540/3	132
590PM3525/4	134	5982/2525/4	128	5982/6060/3	129	5990/3540/4	132
590PM3535/3	134	5982/2530/3	128	5982/6060/4	129	5990/3545/3	132
590PM3535/4	134	5982/2530/4	128	5982/6565/3	129	5990/3545/4	132
590PM3540/3	134	5982/2535/3	128	5982/6565/4	129	5990/3555/3	133
590PM3540/4	134	5982/2535/4	128	5982/7070/3	129	5990/3555/4	133
590PM3545/3	134	5982/2540/3	128	5982/7070/4	129	5990/3565/3	133
590PM3545/4	134	5982/2540/4	128	5982/7575/3	129	5990/3565/4	133
590PM35T25/3	135	5982/2545/3	128	5982/7575/4	129	5990/3575/3	133
590PM35T25/4	135	5982/2545/4	128	5982PT2505/3	131	5990/3575/4	133
590PM35T35/3	135	5982/2550/3	128	5982PT2505/4	131	5990/3595/3	133
590PM35T35/4	135	5982/2550/4	128	5982PT2525/3	131	5990/3595/4	133
590PM4005/3	135	5982/2555/3	128	5982PT2525/4	131	5990/4040/3	132
590PM4005/4	135	5982/2555/4	128	5982PT2535/3	131	5990/4040/4	132
590PM4505/3	135	5982/2560/3	128	5982PT2535/4	131	5990/4050/3	133
590PM4505/4	135	5982/2560/4	128	5982PT2545/3	131	5990/4050/4	133
590PM5005/3	135	5982/2565/3	128	5982PT2545/4	131	5990/4055/3	133
590PM5005/4	135	5982/2565/4	128	5982T40/3	130	5990/4055/4	133
590PM5505/3	135	5982/2575/3	129	5982T40/4	130	5990/4060/3	133
590PM5505/4	135	5982/2575/4	129	5982T45/3	130	5990/4060/4	133
5961/2525/3	144	5982/2585/3	129	5982T45/4	130	5990/4070/3	133
5961/2525/4	144	5982/2585/4	129	5982T50/3	130	5990/4070/4	133
5961/3030/3	144	5982/2595/3	129	5982T50/4	130	5990/4080/3	133
5961/3030/4	144	5982/2595/4	129	5982T55/3	130	5990/4080/4	133
5962/2525/3	145	5982/3030/3	128	5982T55/4	130	5990/4545/3	133
5962/3030/3	145	5982/3030/4	128	5982T60/3	130	5990/4545/4	133
5962/4040/3	145	5982/3035/3	128	5982T60/4	130	5990/4555/3	133
5962T30/3	145	5982/3035/4	128	5982T65/3	130	5990/4555/4	133
5962T40/3	145	5982/3040/3	128	5982T65/4	130	5990/5050/3	133
5963/2222/3	142	5982/3040/4	128	5982T70/3	130	5990/5050/4	133

## ÍNDICE POR REFERENCIA

REF.	PÁG.	REF.	PÁG.	REF.	PÁG.	REF.	PÁG.
5990/5555/3	133	682PM3525/4	138	6982/3060/3	137	6990/3040/4	139
5990/5555/4	133	682PM3535/3	138	6982/3060/4	137	6990/3045/3	139
5990/6060/3	133	682PM3535/4	138	6982/3535/3	136	6990/3045/4	139
5990/6060/4	133	682PM3545/3	138	6982/3535/4	136	6990/3050/3	139
5990/6565/3	133	682PM3545/4	138	6982/3540/3	136	6990/3050/4	139
5990/6565/4	133	682PM3555/3	138	6982/3540/4	136	6990/3055/3	139
5990/7070/3	133	682PM3555/4	138	6982/3545/3	136	6990/3055/4	139
5990/7070/4	133	682PM3565/3	138	6982/3545/4	136	6990/3060/3	140
5990/7575/3	133	682PM3565/4	138	6982/3555/3	137	6990/3060/4	140
5990/7575/4	133	690PM2525/3	141	6982/3555/4	137	6990/3535/3	139
5990PT2505/3	135	690PM2525/4	141	6982/3565/3	137	6990/3535/4	139
5990PT2505/4	135	690PM2535/3	141	6982/3565/4	137	6990/3540/3	139
5990PT2525/3	135	690PM2535/4	141	6982/4040/3	136	6990/3540/4	139
5990PT2525/4	135	690PM2545/3	141	6982/4040/4	136	6990/3545/3	139
5990PT2535/3	135	690PM2545/4	141	6982/4045/3	136	6990/3545/4	139
5990PT2535/4	135	690PM2555/3	141	6982/4045/4	136	6990/3555/3	140
5990PT2545/3	135	690PM2555/4	141	6982/4050/3	137	6990/3555/4	140
5990PT2545/4	135	690PM3030/3	141	6982/4050/4	137	6990/3565/3	140
5990T40/3	134	690PM3030/4	141	6982/4055/3	137	6990/3565/4	140
5990T40/4	134	690PM3525/3	141	6982/4055/4	137	6990/4040/3	139
5990T45/3	134	690PM3525/4	141	6982/4545/3	137	6990/4040/4	139
5990T45/4	134	690PM3535/3	141	6982/4545/4	137	6990/4045/3	139
5990T50/3	134	690PM3535/4	141	6982/4555/3	137	6990/4045/4	139
5990T50/4	134	690PM3545/3	141	6982/4555/4	137	6990/4050/3	140
5990T55/3	134	690PM3545/4	141	6982/4560/3	137	6990/4050/4	140
5990T55/4	134	690PM3555/3	141	6982/4560/4	137	6990/4055/3	140
5990T60/3	134	690PM3555/4	141	6982/5050/3	137	6990/4055/4	140
5990T60/4	134	690PM3565/3	141	6982/5050/4	137	6990/4545/3	140
5990T65/3	134	690PM3565/4	141	6982/5555/3	137	6990/4545/4	140
5990T65/4	134	6964/3030/3	146	6982/5555/4	137	6990/4555/3	140
5990T70/3	134	6964/3030/4	146	6982/6565/3	137	6990/4555/4	140
5990T70/4	134	6964T30/3	146	6982/6565/4	137	6990/4560/3	140
6000D/1N	153	6964T30/4	146	6982/7070/3	137	6990/4560/4	140
6000D/1N1M	153	6968/3030/3	147	6982/7070/4	137	6990/5050/3	140
6000D/6	153	6968/3030/4	147	6982/7575/3	137	6990/5050/4	140
6000I/1N	153	6968T30/3	147	6982/7575/4	137	6990/5555/3	140
6000I/1N1M	153	6968T30/4	147	6982T40/3	138	6990/5555/4	140
6000I/6	153	6982/2525/3	136	6982T40/4	138	6990/6565/3	140
612/25/6	30	6982/2525/4	136	6982T50/3	138	6990/6565/4	140
612/25/6	154	6982/2530/3	136	6982T50/4	138	6990/7070/3	140
612/30/6	30	6982/2530/4	136	6982T60/3	138	6990/7070/4	140
612/30/6	154	6982/2535/3	136	6982T60/4	138	6990/7575/3	140
612/35/6	30	6982/2535/4	136	6982T70/3	138	6990/7575/4	140
612/35/6	154	6982/2540/3	136	6982T70/4	138	6990T40/3	141
612E/25/6	31	6982/2540/4	136	6990/2525/3	139	6990T40/4	141
612E/25/6	155	6982/2545/3	136	6990/2525/4	139	6990T50/3	141
612E/30/6	31	6982/2545/4	136	6990/2530/3	139	6990T50/4	141
612E/30/6	155	6982/2550/3	136	6990/2530/4	139	6990T60/3	141
612E/35/6	31	6982/2550/4	136	6990/2535/3	139	6990T60/4	141
612E/35/6	155	6982/2555/3	136	6990/2535/4	139	6990T70/3	141
615/25/6	30	6982/2555/4	136	6990/2540/3	139	6990T70/4	141
615/25/6	154	6982/2560/3	136	6990/2540/4	139	AE70/6L	10
615/30/6	30	6982/2560/4	136	6990/2545/3	139	AI70/6L	10
615/30/6	154	6982/2565/3	137	6990/2545/4	139	AIK70/6L	10
615/35/6	30	6982/2565/4	137	6990/2550/3	139	B5000	163
615/35/6	154	6982/2575/3	137	6990/2550/4	139	B5000/4	163
615E/25/6	31	6982/2575/4	137	6990/2555/3	139	BAR5000/1R	163
615E/25/6	155	6982/2585/3	137	6990/2555/4	139	BAR5000/1RE	163
615E/30/6	31	6982/2585/4	137	6990/2560/3	139	BAR5000/1RE2	163
615E/30/6	155	6982/2595/3	137	6990/2560/4	139	BAR5000/6	163
615E/35/6	31	6982/2595/4	137	6990/2565/3	140	BAR5000/6E	163
615E/35/6	155	6982/3030/3	136	6990/2565/4	140	BTI296/1N	55
682PM2525/3	138	6982/3030/4	136	6990/2575/3	140	BTI94/1N	55
682PM2525/4	138	6982/3035/3	136	6990/2575/4	140	BTI94/1N	96
682PM2535/3	138	6982/3035/4	136	6990/2585/3	140	CE184/0L	44
682PM2535/4	138	6982/3040/3	136	6990/2585/4	140	CE184/0LAN	44
682PM2545/3	138	6982/3040/4	136	6990/2595/3	140	CE184/1N	44
682PM2545/4	138	6982/3045/3	136	6990/2595/4	140	CE184/1NR	44
682PM2555/3	138	6982/3045/4	136	6990/3030/3	139	CE184/1NRS	44
682PM2555/4	138	6982/3050/3	136	6990/3030/4	139	CE184/6L	44
682PM3030/3	138	6982/3050/4	136	6990/3035/3	139	CE184/6LAN	44
682PM3030/4	138	6982/3055/3	136	6990/3035/4	139	CE184/6U	44
682PM3525/3	138	6982/3055/4	136	6990/3040/3	139	CE184A/6L	44



**ÍNDICE POR REFERENCIA**

REF.	PÁG.	REF.	PÁG.	REF.	PÁG.	REF.	PÁG.
CE190/0	92	CE249R/2	124	ES1960	125	P192V25/6SC	40
CE190/6	92	CE249R/6	124	ES1960/4	125	P192V30/6SC	40
CE196/1N	45	CE296S/1NR	47	ES1962	125	P192V35/6SC	40
CE196/1NR	46	CE296S/1NRS	47	ES1962/4	125	P198K25/6	62
CE196/1NRS	46	CE296S/6L	46	ES1963	96	P198K30/6	62
CE196/6L	45	CE296S/6LAN	46	ES1964	96	P198K35/6	62
CE196/6LAN	45	CE296S/6LR	46	ES1964	125	P198KB25/6	62
CE196/6LR	45	CE296S/6RU	47	ES1984	55	P198KB30/6	62
CE196/6U	45	CE296S/6U	46	ES1984	96	P198KB35/6	62
CE1960/2	124	CE2994S/6	94	ES1985/0	125	P198KD20/6	62
CE1960/6	124	CE2A2S/1N22	48	ES1985/7	125	P1E2/30/6	18
CE1960A/2	124	CE2A2S/1NR	48	FA12VDC3A1	166	P1E2/35/6	18
CE1960A/6	124	CE2A2S/1NRS	48	JES6000/6R	54	P1E2/40/6	18
CE196R/6L	94	CE2A2S/6L	48	JM6006/85/1B	53	P1E2/50/6	18
CE196R/6L	47	CE2A2S/6LR	48	JM6006/85/1N	53	P2E2/30/6	16
CE196R/6LAN	47	CE3I2PCICE	56	JM6006/85/6R	53	P2E2/35/6	16
CE196R/6LR	47	CE4000/2	123	JM6006P/85/1B	53	P2E2/40/6	16
CE1970A/2	124	CE4000/6	123	JM6006P/85/1N	53	P2E2/50/6	16
CE1970A/6	124	CE4001/2	123	JMB6000/6R	53	P2E2GB30/6	15
CE1970R/2	124	CE4001/6	123	JT6006/85/6R	54	P2E2GB35/6	15
CE1970R/6	124	CE5000/1N	163	KCE1K5/1NR	49	P2E2GB40/6	15
CE1975R/0	94	CE5000/6	163	KCE1K5/1NRS	49	P2E2GB50/6	15
CE1983/6	92	CEB6000	163	KCE1K5/6L	49	P2I2/30/6	28
CE1984/0	92	CEB6000/1N	163	KCE1K5/6LR	49	P2I2/33/6	28
CE1984/6	92	CEC41/6AD	52	KES4000	125	P2I2/35/6	28
CE1985/2	123	CEC41T/6AD	52	KES4100	125	P2I2GB30/6	27
CE1985/6	123	CELC45/6A	95	KLECH1/6	166	P2I2GB33/6	27
CE1990/0	93	CELC45/6AD	95	KLECP1	166	P2I2GB35/6	27
CE1991/0	93	CELC45T/6A	95	KLECT1/N	166	PASCABO1	166
CE1994/6	93	CELC45T/6AD	95	KSM2A2	13	PASCABS1	166
CE202GB/1NR	50	CM5006D55/6R	161	KTVCE13	56	PCF3I2ICE	56
CE202GB/1NRS	50	CM5006D72/6R	161	KTVCE15	56	PCI3I2CE	56
CE202GB/6L	50	CM5006D85/6R	161	LLAVERO1	166	POLCE-CVL	56
CE202GB/6LAN	51	CM5006I55/6R	161	M5000D/1N	162	TAG1	166
CE202GB6LR18	51	CM5006I72/6R	161	M5000I/1N	162	TAP1E5	56
CE202GB6LR20	51	CM5006I85/6R	161	M5001D/1N	162	TARJ1	166
CE202S/1NR	50	CM5007D/6R	161	M5001I/1N	162	TUF6000/1N	163
CE202S/1NRS	50	CM5007I/6R	161	M5002/1N	162	TUF6000/1NE	163
CE202S/6L	50	CONNECT01	56	M5003/1N	162	TUF6000/1NE2	163
CE202S/6LAN	50	CV1E5	56	M5004/1N	162	TUF6000/6	163
CE202S/6LR18	51	EMB196	56	P192/25/6SC	40	TUF6000/6E	163
CE202S/6LR20	51	ES184/1B	55	P192/30/6SC	40		
CE202S/6U	51	ES184/1N	55	P192/35/6SC	40		

## CONDICIONES DE VENTA

- Giro a 60 días fecha factura, en aplicación Ley 15/2010 del 5 de Julio.
- Los precios de esta tarifa están sujetos al impuesto IVA.
- Los pedidos superiores a 500 € se pondrán en destino a portes pagados cuando la entrega se realice por las agencias de transporte seleccionadas por CVL (Península y Baleares).
- Canarias: pedidos superiores a 1.000 € se pondrán en destino a portes pagados.
- Los portes serán a cargo del cliente si la agencia de transporte indicada por éste no es una de las seleccionadas por CVL
- Los pedidos inferiores a 500 € tendrán un recargo de 6,01 € fijos más un 3% en concepto de portes. (Península y Baleares).
- Canarias: pedidos inferiores a 1.000 €. consultar porte.
- Todo pedido implica la aceptación, sin reservas, de todas las condiciones de venta.
- Los códigos EAN corresponden siempre a la cerradura estándar completa.
- La empresa se reserva el derecho a modificar sin previo aviso sus modelos, características y especificaciones.

### ABREVIATURAS DE ACABADOS CERRADURAS Y CILINDROS

COD.	FRENTE	CILINDRO
/0	Hierro Niquelado ( <b>HN</b> )	Latón Niquelado ( <b>CN</b> )
/1	Hierro Esmaltado ( <b>HE</b> )	Latón Pulido ( <b>LP</b> )
/2	Hierro Latonado ( <b>HL</b> )	Latón Pulido ( <b>LP</b> )
/3		Latón Pulido ( <b>LP</b> )
/4		Latón Niquelado ( <b>CN</b> )
/5	Hierro Niquelado ( <b>HN</b> )	Latón Pulido ( <b>LP</b> )
/6	Acero Inoxidable ( <b>AI</b> )	Latón Niquelado ( <b>CN</b> )
/7	Níquel Satinado ( <b>NS</b> )	Latón Niquelado ( <b>CN</b> )

### ABREVIATURAS DE ACABADOS DE ANTIPÁNICOS Y ESCUDOS

COD.	ACABADO
/0	Niquelado
/1N	Pintado negro
/1NM	Pintado níquel mate
/2	Latonado
/6	Acero inoxidable
/7	Níquel mate

SOLUCIÓN PARA PUERTAS ALTAS BATIENTES Y CORREDERA ..... 10

**SOLUCIÓN PORTAL.....11**
**SOLUCIÓN AUTOMÁTICA / MOTORIZADA.....12**
**Multipunto automática entre ejes 92 mm .....13**

 • Serie 2A2 **iself** .....13

**Multipunto palanca deslizante entre ejes 92 mm .....14**

 • Serie 4E25 **soft** .....14

 • Serie 2E2GB **soft** .....15

 • Serie 2E2 **soft** .....16

**Palanca deslizante entre ejes 92 mm.....18**

 • Serie 1E2 **soft** .....18

**Multipunto palanca deslizante entre ejes 85 mm .....20**

 • Serie 2E5 **soft** .....20

**Palanca deslizante entre ejes 85 mm.....22**

 • Serie 1E5 **soft** .....22

**Multipunto palanca basculante entre ejes 85 mm .....24**

 • Serie 2K5 **DUE** .....24

**Palanca basculante entre ejes 85 mm.....25**

 • Serie 1K5 **DUE** .....25

**Multipunto palanca deslizante entre ejes 92 mm .....26**

 • Serie 4I25 **inverse** .....26

 • Serie 2I2GB **inverse** .....27

 • Serie 2I2 **inverse** .....28

**Multipunto palanca deslizante .....29**

 • Serie 3I2, 3I5 **inverse** .....29

**Cerradura antipánico palanca deslizante.....30**

 • Series 615, 612 **alupanic**.....30

 • Series 615E, 612E **alupanic** .....31

**Cerradura cortafuego entre ejes 92 mm .....32**

• Serie 194F.....32

**Palanca deslizante entre ejes 85 mm.....33**

• Serie 184 .....33

**Multipunto palanca basculante entre ejes 85 mm .....35**

• Serie 296 .....35

**Palanca basculante entre ejes 85 mm.....37**

• Serie 196 .....37

**Palanca gancho entre ejes 85 mm .....39**

• Serie 197 .....39

**Palanca deslizante entre ejes 92 mm.....40**

• Serie 192 .....40

**Multipunto palanca basculante entre ejes 92 mm .....41**

• Serie 294N.....41

**Palanca basculante entre ejes 92 mm.....43**

• Serie 194 .....43

**Accesorios.....44**

• Cerraderos .....44

• Cerraderos eléctricos.....52

• Escudos y manillas de acero inoxidable.....53

• Escudos .....55

• Otros .....56

**Multipunto palanca gancho entre ejes 85 mm .....57**

• Serie 4I54K .....57

• Serie 2I5K .....58

**Palanca gancho entre ejes 85 mm .....59**

• Serie 1I5K .....59

**Multipunto palanca gancho .....60**

• Serie 297K.....60

**Palanca gancho y antifalsa maniobra.....61**

• Serie 197KBN.....61

**Palanca gancho con cilindro Europerfil .....62**

• Serie 198K.....62

**Palanca gancho con cilindro tetra.....63**

• Serie 1T8 .....63

**PUERTAS BATIENTES**
**PUERTAS CORREDERAS**

## SOLUCIÓN PARA PUERTAS ALTAS BATIENTES Y CORREDERA

## BATIENTES

## CORREDERA

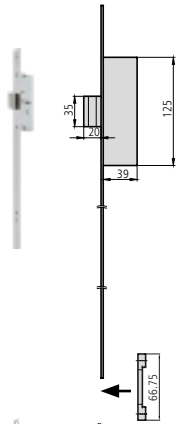

**AE70**  
(ver abajo)



**AE25**  
(ver pág. 14)

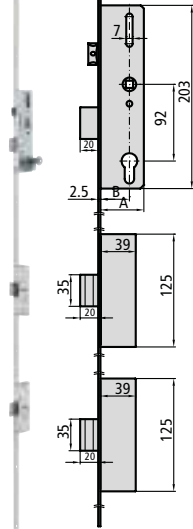

**Soft**

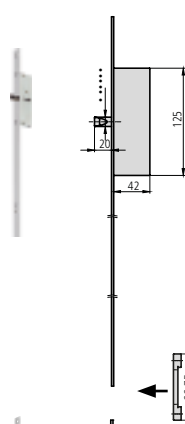

**AI70**  
(ver abajo)

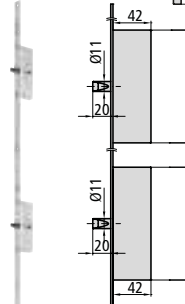

**AI25**  
(ver pág. 26)

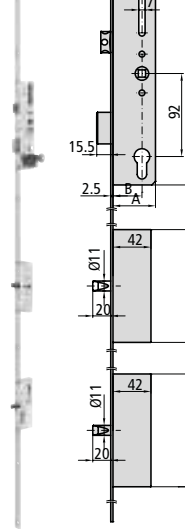

**inve@se**

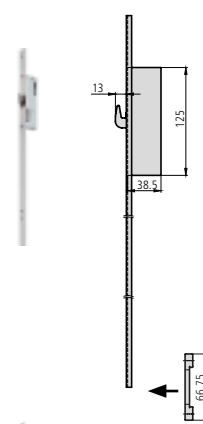

**AIK70**  
(ver abajo)

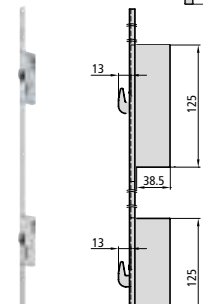

**AI54K**  
(ver pág. 57)

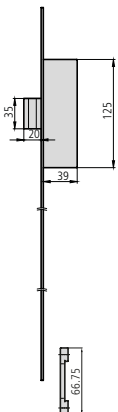
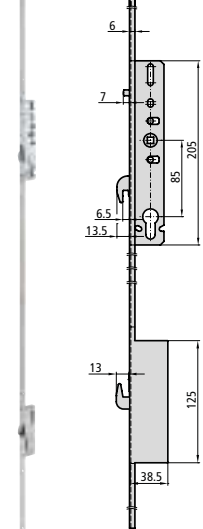

**AE70**

- Kit acople y punto de cierre adicional para cerradura de 2300 mm.
- Palanca deslizante.
- Frente inox.
- Frente de 700 mm de largo.

AE70/6L

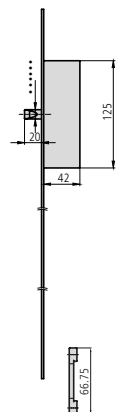

**AI70**

- Kit acople y punto de cierre adicional para cerradura de 2300 mm.
- Con bulón.
- Frente inox.
- Frente de 700 mm de largo.

AI70/6L

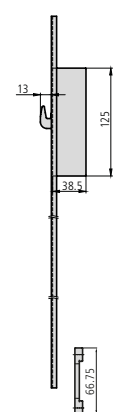

**AIK70**

- Kit acople y punto de cierre adicional para cerradura de 2300 mm.
- Palanca de gancho.
- Frente inox.
- Frente de 700 mm de largo.

AIK70/6L

**Novedad**

## PUERTAS BATIENTES

MULTIPUNTO AUTOMÁTICA ENTRE EJES 92 mm

SERIE 2A2 **iSelf**

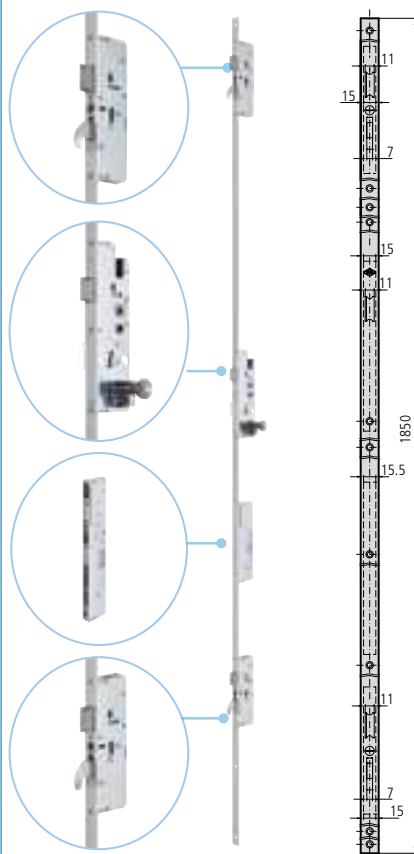

### CARACTERÍSTICAS

- Sistema de cierre autónomo mediante 3 resbalones y 2 ganchos alto/bajo
- Disparo automático de los ganchos alto/bajo (independientes) mediante tecnología magnética
- Fondo de caja 15 mm: evita el mecanizado del perfil en la parte trasera
- Atado de manilla pasante a 21,5 mm  
↓ y a partir de 45 mm ↑ .
- Frente liso inox de 16 mm, 22 mm, 24 mm y U 24,5\*6
- Resbalones reversibles mediante sistema semiautomático
- Caja cerrada de 15 mm
- Cuadradillo de 8 mm
- Cerraderos de serie
- Tornillo de fijación de cilindro

### ACCESORIOS OPCIONALES

- Gama completa de cerraderos (ver páginas 44 - 51)
- Gama completa de cilindros (ver página 128 - 148)

### OTRAS OPCIONES

- Posibilidad de distintas alturas de frente.

### DESCRIPCIÓN

REF.

MEDIDAS  
B A

LEVA

ACABADOS  
FRENTE CILINDRO

UDS  

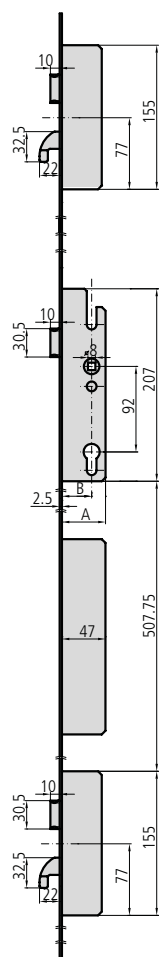

- Cilindro no incluido
- Motor incluido

**Opciones de cerradero**  
(ver páginas 44 - 51)

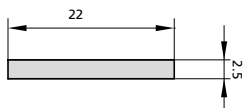

2A2M30/6L	27	42	15	Al	1
2A2M35/6L	32	47	15	Al	1
2A2M45/6L	42	57	15	Al	1



**Novedad**

# solución AUTOMÁTICA / MOTORIZADA

## PUERTAS BATIENTES

### Soluciones de apertura



**Novedad**

**PUERTAS BATIENTES**



ALUMINIO

**MULTIPUNTO AUTOMÁTICA ENTRE EJES 92 mm**

**SERIE 2A2 *iself***

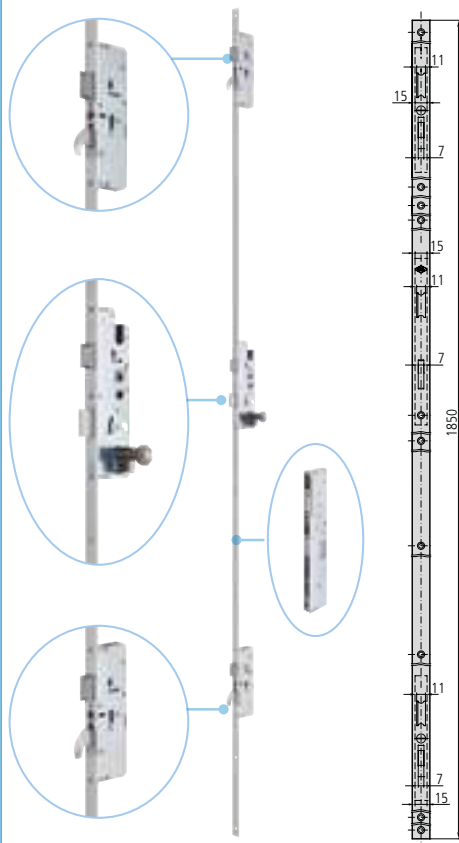

**CARACTERÍSTICAS**

- Sistema de cierre autónomo mediante 3 resbalones y 2 ganchos alto/bajo
- Disparo automático de los ganchos alto/bajo (independientes) mediante tecnología magnética
- Bloqueo total del sistema mediante palanca deslizante central accionada con llave
- Fondo de caja 15 mm: evita el mecanizado del perfil en la parte trasera
- Atado de manilla pasante a 21,5 mm ↓ y a partir de 45 mm ↑
- Frente liso inox de 16 mm, 22 mm, 24 mm y U 24,5\*6
- Resbalones reversibles mediante sistema semiautomático
- Caja cerrada de 15 mm
- Cuadradillo de 8 mm
- Cerraderos de serie
- Tornillo de fijación de cilindro

**ACCESORIOS OPCIONALES**

- Gama completa de cerraderos (ver páginas 44 - 51)
- Gama completa de cilindros (ver página 128 - 148)

**OTRAS OPCIONES**

- Posibilidad de distintas alturas de frente.

DESCRIPCIÓN	REF.	MEDIDAS		LEVA	ACABADOS		UDS
		B	A		FRENTE	CILINDRO	

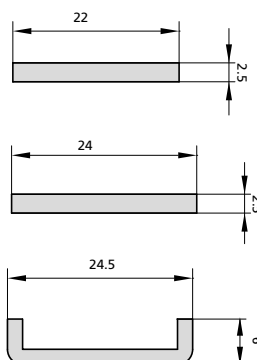
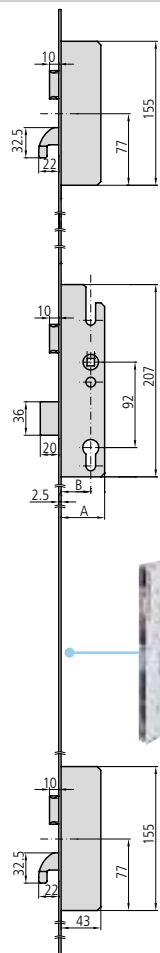

2A2/30/6L	27	42	15	Al	1
2A2/35/6L	32	47	15	Al	1
2A2/45/6L	42	57	15	Al	1
2A2/30/6LAN	27	42	15	Al	1
2A2/35/6LAN	30	45	15	Al	1
2A2/45/6LAN	32	47	15	Al	1
2A2/30/6U	23	38	15	Al	1
2A2/35/6U	28	43	15	Al	1
2A2/45/6U	38	53	15	Al	1

- Cilindro no incluido
- Motor no incluido

**Opciones de cerradero**  
(ver páginas 44 - 51)

DESCRIPCIÓN	REF.
• Suplemento electro-mecánico inteligente para motorización de la cerradura	KSM2A2



## PUERTAS BATIENTES

## MULTIPUNTO PALANCA DESLIZANTE ENTRE EJES 92 mm

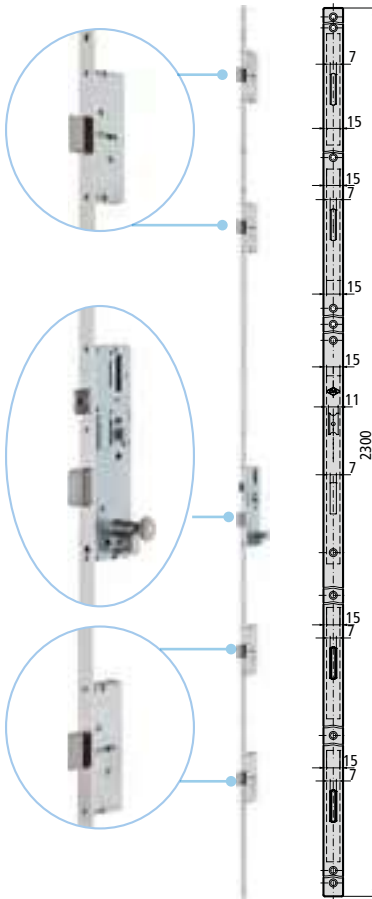
SERIE 4E25 **Soft**

## CARACTERÍSTICAS

- Máxima suavidad entre engranajes
- Cerradura de 5 puntos con frente liso inox de 22 mm
- Frente de 2300 mm de largo
- Picaporte reversible y regulable de 11 mm
- Punto alto y bajo con palanca deslizante
- Mínimo stock: 3 versiones en 1 cerradura (picaporte/rodillo/sólo palanca)
- Palanca deslizante
- Diseño según norma EN12209 y pr. EN 15685
- Compatible con cilindros de leva corta y leva larga/ DIN
- Caja cerrada de 15 mm
- Cuadradillo de 8 mm
- Tornillo de fijación de cilindro

## ACCESORIOS OPCIONALES

- Gama completa de cerraderos (ver páginas 44 - 51)
- Gama completa de cilindros (ver página 128 - 148)
- Kit acople y punto de cierre adicional (ver página 10)
- Kit vaivén para sustituir picaporte (ref. CV1E5) (ver página 56)

## DESCRIPCIÓN

## REF.

MEDIDAS  
B A

## LEVA

ACABADOS  
FRENTE CILINDRO

## UDS

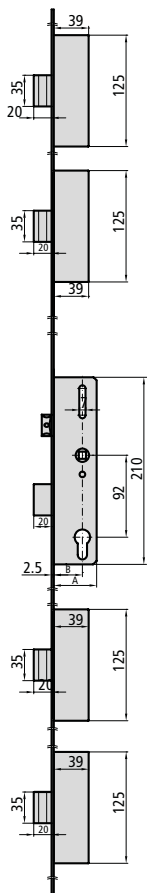
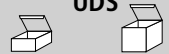

- Picaporte y palanca
- Cilindro no incluido

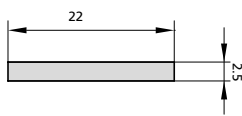
Opciones de cerradero  
(ver páginas 44 - 51)

4E25/30/6L	27	43	15/13,25	Al	1
4E25/35/6L	32	48	15/13,25	Al	1
4E25/40/6L	37	53	15/13,25	Al	1
4E25/50/6L	47	63	15/13,25	Al	1



MULTIPUNTO PALANCA DESLIZANTE ENTRE EJES 92 mm

SERIE 2E2GB **Soft**

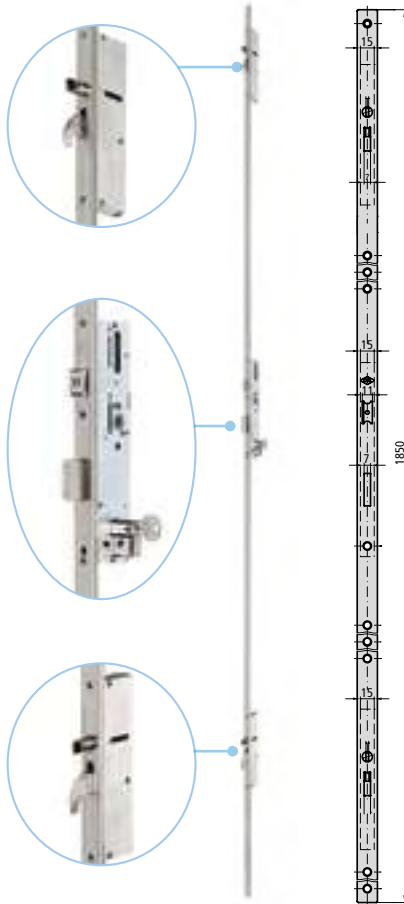

CARACTERÍSTICAS

- Máxima suavidad entre engranajes
- Cerradura multipunto con frente liso inox de 16 mm, 22 mm, 24 mm y U 24,5\*6
- Frente de 1850 mm de largo
- Picaporte reversible y regulable de 11 mm
- Punto alto y bajo con gancho y bullón
- Mínimo stock: 3 versiones en 1 cerradura (picaporte/rodillo/sólo palanca)
- Palanca deslizante
- Diseño según norma EN12209 y pr. EN 15685
- Compatible con cilindros de leva corta y leva larga/ DIN
- Caja cerrada de 15 mm
- Cuadradillo de 8 mm
- Tornillo de fijación de cilindro

ACCESORIOS OPCIONALES

- Gama completa de cerraderos (ver páginas 44 - 51)
- Gama completa de cilindros (ver página 128 - 148)
- Frente de 2300 mm de largo opcional (serie 4E2GB)
- Frente de 1500 mm de largo opcional (serie 5E2GB)
- Kit vaivén para sustituir picaporte (ref. CV1E5) (ver página 56)

DESCRIPCIÓN	REF.	MEDIDAS		LEVA	ACABADOS		UDS
		B	A		FRENTE	CILINDRO	

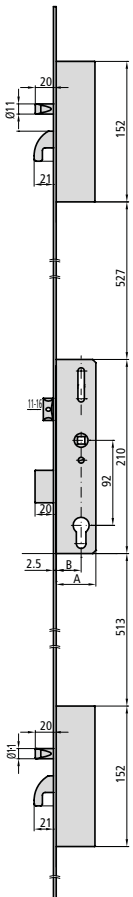

- Picaporte y palanca
- Cilindro no incluido

Opciones de cerradero (ver páginas 44 - 51)

	P2E2GB30/6	27	43	15/13,25	Al	1
	P2E2GB35/6	32	48	15/13,25	Al	1
	P2E2GB40/6	37	53	15/13,25	Al	1
	P2E2GB50/6	47	63	15/13,25	Al	1
	2E2GB30/6L	27	43	15/13,25	Al	1
	2E2GB35/6L	32	48	15/13,25	Al	1
	2E2GB40/6L	37	53	15/13,25	Al	1
	2E2GB50/6L	47	63	15/13,25	Al	1
	2E2GB30/6LAN	27	43	15/13,25	Al	1
	2E2GB35/6LAN	32	48	15/13,25	Al	1
	2E2GB40/6LAN	37	53	15/13,25	Al	1
	2E2GB50/6LAN	47	63	15/13,25	Al	1
	2E2GB30/6U	23	39	15/13,25	Al	1
	2E2GB35/6U	28	44	15/13,25	Al	1
	2E2GB40/6U	33	49	15/13,25	Al	1
	2E2GB50/6U	43	59	15/13,25	Al	1

## PUERTAS BATIENTES

## MULTIPUNTO PALANCA DESLIZANTE ENTRE EJES 92 mm

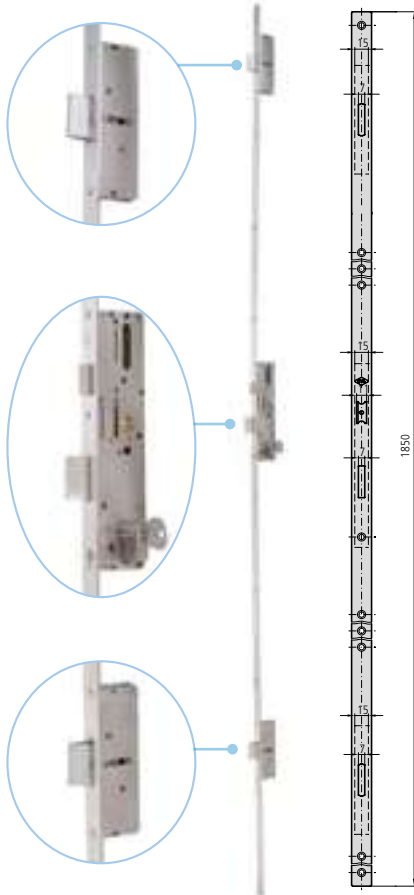
SERIE 2E2 **Soft**

## CARACTERÍSTICAS

- Máxima suavidad entre engranajes
- Cerradura de 3 puntos con frente liso inox de 16 mm, 22 mm, 24 mm y U 24,5\*6
- Frente de 1850 mm de largo
- Picaporte reversible y regulable de 11 mm
- Mínimo stock: 3 versiones en 1 cerradura (picaporte/rodillo/sólo palanca)
- Palanca deslizante
- Diseño según norma EN12209 y pr. EN 15685
- Compatible con cilindros de leva corta y leva larga/ DIN
- Caja cerrada de 15 mm
- Cuadradillo de 8 mm
- Tornillo de fijación de cilindro

## ACCESORIOS OPCIONALES

- Gama completa de cerraderos (ver páginas 44 - 51)
- Gama completa de cilindros (ver página 128 - 148)
- Frente de 2300 mm de largo opcional (serie 4E2)
- Frente de 1500 mm de largo opcional (serie 5E2)
- Kit vaivén para sustituir picaporte (ref. CV1E5) (ver página 56)

## DESCRIPCIÓN

## REF.

MEDIDAS  
B A

## LEVA

ACABADOS  
FRENTE CILINDRO

## UDS

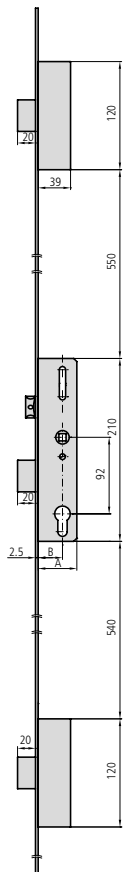
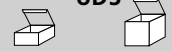

- Picaporte y palanca
- Cilindro no incluido

Opciones de cerradero  
(ver páginas 44 - 51)

	P2E2/30/6	27	43	15/13,25	Al	1
	P2E2/35/6	32	48	15/13,25	Al	1
	P2E2/40/6	37	53	15/13,25	Al	1
	P2E2/50/6	47	63	15/13,25	Al	1
	2E2/30/6L	27	43	15/13,25	Al	1
	2E2/35/6L	32	48	15/13,25	Al	1
	2E2/40/6L	37	53	15/13,25	Al	1
	2E2/50/6L	47	63	15/13,25	Al	1
	2E2/30/6LAN	27	43	15/13,25	Al	1
	2E2/35/6LAN	32	48	15/13,25	Al	1
	2E2/40/6LAN	37	53	15/13,25	Al	1
	2E2/50/6LAN	47	63	15/13,25	Al	1
	2E2/30/6U	23	39	15/13,25	Al	1
	2E2/35/6U	28	44	15/13,25	Al	1
	2E2/40/6U	33	49	15/13,25	Al	1
	2E2/50/6U	43	59	15/13,25	Al	1

MULTIPUNTO PALANCA DESLIZANTE ENTRE EJES 92 mm

SERIE 2E2 *Soft*

DESCRIPCIÓN	REF.	MEDIDAS		LEVA	ACABADOS		UDS
		B	A		FRENTE	CILINDRO	

- Rodillo vaivén regulable de nylon y palanca
- Cilindro no incluido

Opciones de cerradero  
(ver páginas 44 - 51)

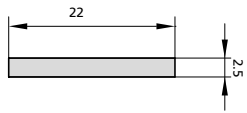
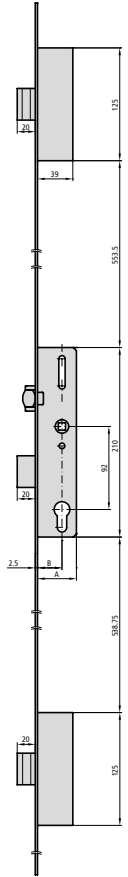

2E2NV/30/6L	27	43	15/13,25	Al	1
2E2NV/35/6L	32	48	15/13,25	Al	1
2E2NV/40/6L	37	53	15/13,25	Al	1
2E2NV/50/6L	47	63	15/13,25	Al	1

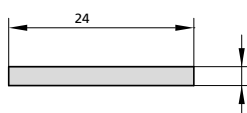

2E2NV/30/6LAN	27	43	15/13,25	Al	1
2E2NV/35/6LAN	32	48	15/13,25	Al	1
2E2NV/40/6LAN	37	53	15/13,25	Al	1
2E2NV/50/6LAN	47	63	15/13,25	Al	1

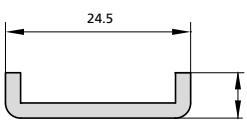

2E2NV/30/6U	23	39	15/13,25	Al	1
2E2NV/35/6U	28	44	15/13,25	Al	1
2E2NV/40/6U	33	49	15/13,25	Al	1
2E2NV/50/6U	43	59	15/13,25	Al	1

## PUERTAS BATIENTES

## PALANCA DESLIZANTE ENTRE EJES 92 mm

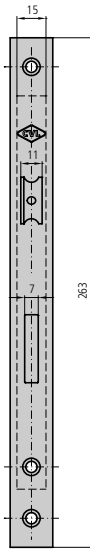
SERIE 1E2 **Soft**

## CARACTERÍSTICAS

- Máxima suavidad entre engranajes
- Frente liso inox de 16 mm, 22 mm, 24 mm y U 24,5\*6
- Picaporte reversible y regulable de 11 mm
- Mínimo stock: 3 versiones en 1 cerradura (picaporte/rodillo/sólo palanca)
- Palanca deslizante
- Diseño según norma EN12209 y pr. EN 15685
- Compatible con cilindros de leva corta y leva larga/ DIN
- Caja cerrada de 15 mm
- Cuadradillo de 8 mm
- Tornillo de fijación de cilindro

## ACCESORIOS OPCIONALES

- Gama completa de cerraderos (ver páginas 44 - 51)
- Gama completa de cilindros (ver página 128 - 148)
- Kit vaivén para sustituir picaporte (ref. CV1E5) (ver página 56)

DESCRIPCIÓN	REF.	MEDIDAS		LEVA	ACABADOS		UDS
		B	A		FRENTE	CILINDRO	

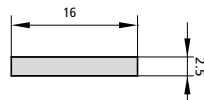

P1E2/30/6	27	43	15/13,25	Al		1
P1E2/35/6	32	48	15/13,25	Al		1
P1E2/40/6	37	53	15/13,25	Al		1
P1E2/50/6	47	63	15/13,25	Al		1

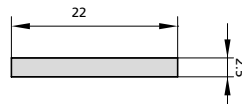

1E2/30/6	27	43	15/13,25	Al		1
1E2/35/6	32	48	15/13,25	Al		1
1E2/40/6	37	53	15/13,25	Al		1
1E2/50/6	47	63	15/13,25	Al		1

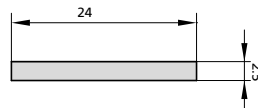

1E2/30/6AN	27	43	15/13,25	Al		1
1E2/35/6AN	32	48	15/13,25	Al		1
1E2/40/6AN	37	53	15/13,25	Al		1
1E2/50/6AN	47	63	15/13,25	Al		1

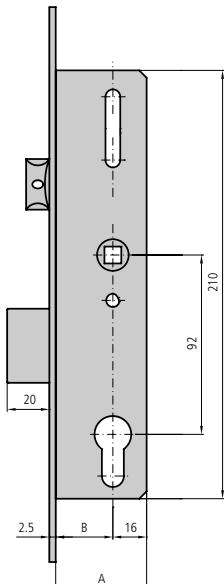

- Picaporte y palanca
- Cilindro no incluido

**Opciones de cerradero**  
(ver páginas 44 - 51)

DESCRIPCIÓN	REF.	MEDIDAS		LEVA	ACABADOS		UDS
		B	A		FRENTE	CILINDRO	

- Rodillo vaivén regulable de nylon y palanca
- Cilindro no incluido

**Opciones de cerradero**  
(ver páginas 44 - 51)

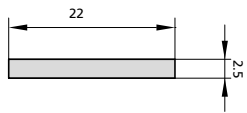
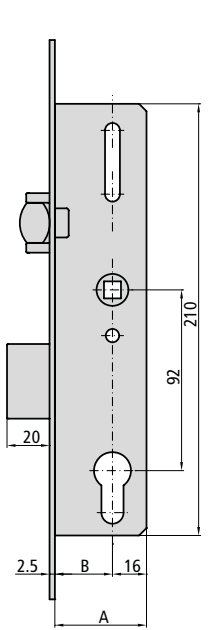

1E2NV/30/6	27	43	15/13,25	Al	1
1E2NV/35/6	32	48	15/13,25	Al	1
1E2NV/40/6	37	53	15/13,25	Al	1
1E2NV/50/6	47	63	15/13,25	Al	1

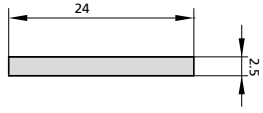

1E2NV/30/6AN	27	43	15/13,25	Al	1
1E2NV/35/6AN	32	48	15/13,25	Al	1
1E2NV/40/6AN	37	53	15/13,25	Al	1
1E2NV/50/6AN	47	63	15/13,25	Al	1

## PUERTAS BATIENTES

## MULTIPUNTO PALANCA DESLIZANTE ENTRE EJES 85 mm.

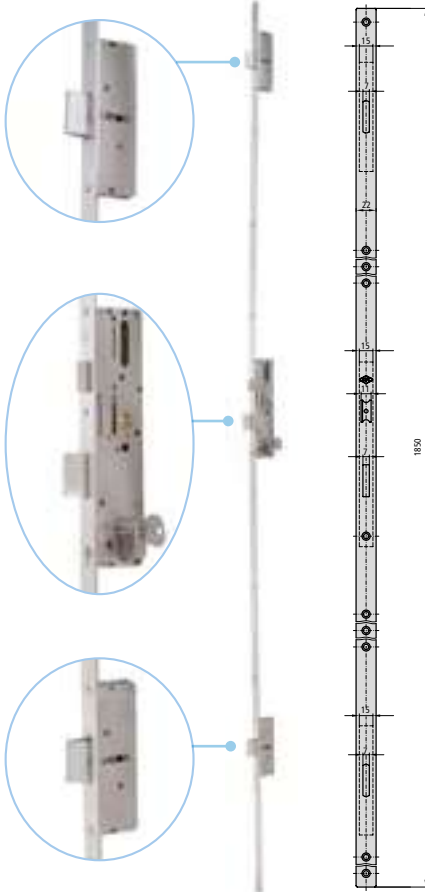
SERIE 2E5 **Soft**

## CARACTERÍSTICAS

- Máxima suavidad mediante engranajes
- Cerradura de 3 puntos con frente liso inox de 22 mm, 24 mm y U 24,5\*6
- Frente de 1850 mm de largo
- Picaporte reversible y regulable de 11 mm
- Mínimo stock: 3 versiones en 1 cerradura (picaporte/rodillo/sólo palanca)
- Palanca deslizante
- Diseño según norma EN12209 y pr. EN 15685
- Compatible con cilindros de leva corta y leva larga/ DIN
- Caja cerrada de 15 mm
- Cuadradillo de 8 mm
- Tornillo de fijación de cilindro

## ACCESORIOS OPCIONALES

- Gama completa de cerraderos (ver páginas 44 - 51)
- Gama completa de cilindros (ver página 128 - 148)
- Frente de 2300 mm de largo opcional (serie 4E5)
- Frente de 1500 mm de largo opcional (serie 5E5)
- Kit vaivén para sustituir picaporte (ref. CV1E5) (ver página 56)

## DESCRIPCIÓN

## REF.

MEDIDAS  
B A

## LEVA

ACABADOS  
FRENTE CILINDRO

## UDS

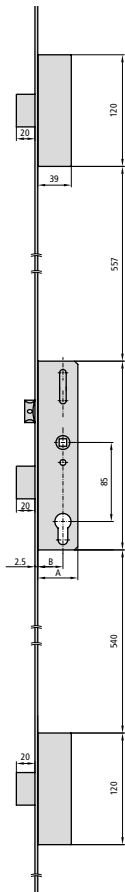

- Picaporte y palanca
- Cilindro no incluido

Opciones de cerradero  
(ver páginas 44 - 51)

	2E5/30/6L	27	43	15/13,25	Al	1
	2E5/35/6L	32	48	15/13,25	Al	1
	2E5/40/6L	37	53	15/13,25	Al	1
	2E5/50/6L	47	63	15/13,25	Al	1
	2E5/30/6LAN	27	43	15/13,25	Al	1
	2E5/35/6LAN	32	48	15/13,25	Al	1
	2E5/40/6LAN	37	53	15/13,25	Al	1
	2E5/50/6LAN	47	63	15/13,25	Al	1
	2E5/30/6U	23	39	15/13,25	Al	1
	2E5/35/6U	28	44	15/13,25	Al	1
	2E5/40/6U	33	49	15/13,25	Al	1
	2E5/50/6U	43	59	15/13,25	Al	1

DESCRIPCIÓN	REF.	MEDIDAS		LEVA	ACABADOS		UDS
		B	A		FRENTE	CILINDRO	

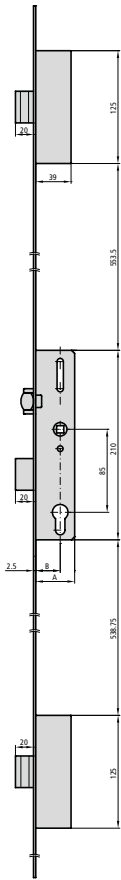

- Rodillo vaivén regulable de nylon y palanca
- Cilindro no incluido

**Opciones de cerradero**  
(ver páginas 44 - 51)

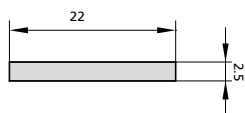

2E5NV/30/6L	27	43	15/13,25	Al	1
2E5NV/35/6L	32	48	15/13,25	Al	1
2E5NV/40/6L	37	53	15/13,25	Al	1
2E5NV/50/6L	47	63	15/13,25	Al	1

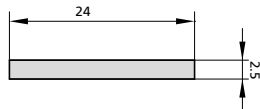

2E5NV/30/6LAN	27	43	15/13,25	Al	1
2E5NV/35/6LAN	32	48	15/13,25	Al	1
2E5NV/40/6LAN	37	53	15/13,25	Al	1
2E5NV/50/6LAN	47	63	15/13,25	Al	1

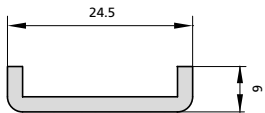

2E5NV/30/6U	23	39	15/13,25	Al	1
2E5NV/35/6U	28	44	15/13,25	Al	1
2E5NV/40/6U	33	49	15/13,25	Al	1
2E5NV/50/6U	43	59	15/13,25	Al	1

## PUERTAS BATIENTES

## PALANCA DESLIZANTE ENTRE EJES 85 mm.

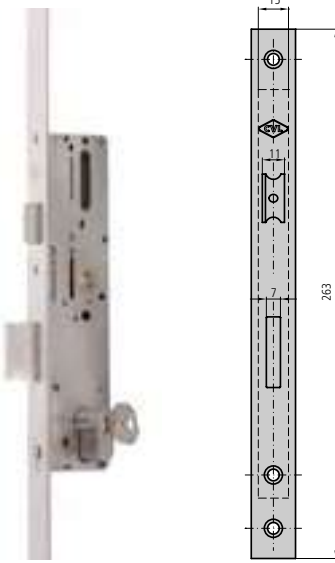
SERIE 1E5 **Soft**

## CARACTERÍSTICAS

- Máxima suavidad mediante engranajes
- Cerradura de 1 punto con frente liso inox de 22 mm, 24 mm y U 24,5\*6
- Picaporte reversible y regulable de 11 mm
- Mínimo stock: 3 versiones en 1 cerradura (picaporte/rodillo/sólo palanca)
- Palanca deslizante
- Diseño según norma EN12209 y pr. EN 15685
- Compatible con cilindros de leva larga y leva corta/DIN
- Caja cerrada de 15 mm
- Cuadradillo de 8 mm
- Tornillo de fijación de cilindro

## ACCESORIOS OPCIONALES

- Gama completa de cerraderos (ver páginas 44 - 51)
- Gama completa de cilindros (ver página 128 - 148)
- Kit vaivén para sustituir picaporte (ref. CV1E5) (ver página 56)

## DESCRIPCIÓN

## REF.

MEDIDAS  
B A

## LEVA

ACABADOS  
FRENTE CILINDRO

## UDS

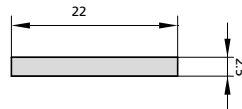

1E5/30/6	27	43	15/13,25	Al	1
1E5/35/6	32	48	15/13,25	Al	1
1E5/40/6	37	53	15/13,25	Al	1
1E5/50/6	47	63	15/13,25	Al	1

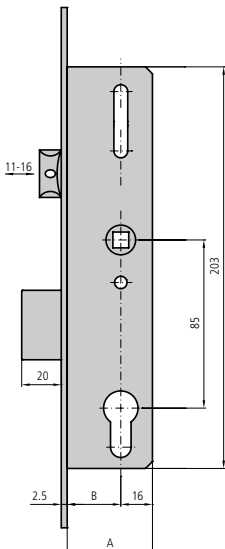

- Picaporte y palanca
- No incluye cilindro

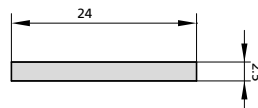
Opciones de cerradero  
(ver páginas 44 - 51)

1E5/30/6AN	27	43	15/13,25	Al	1
1E5/35/6AN	32	48	15/13,25	Al	1
1E5/40/6AN	37	53	15/13,25	Al	1
1E5/50/6AN	47	63	15/13,25	Al	1



PALANCA DESLIZANTE ENTRE EJES 85 mm.

SERIE 1E5 *Soft*

DESCRIPCIÓN	REF.	MEDIDAS		LEVA	ACABADOS		UDS
		B	A		FRENTE	CILINDRO	

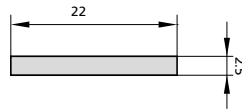
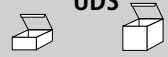

1E5NV/30/6	27	43	15/13,25	Al		1
1E5NV/35/6	32	48	15/13,25	Al		1
1E5NV/40/6	37	53	15/13,25	Al		1
1E5NV/50/6	47	63	15/13,25	Al		1

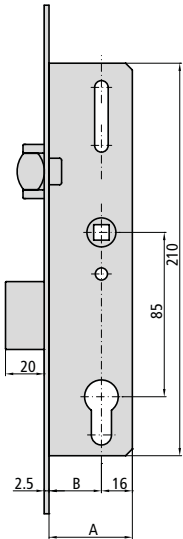

- Rodillo vaivén regulable de nylon y palanca
- No incluye cilindro

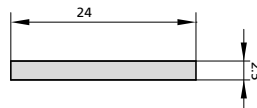

**Opciones de cerradero**  
(ver páginas 44 - 51)

1E5NV/30/6AN	27	43	15/13,25	Al		1
1E5NV/35/6AN	32	48	15/13,25	Al		1
1E5NV/40/6AN	37	53	15/13,25	Al		1
1E5NV/50/6AN	47	63	15/13,25	Al		1



## MULTIPUNTO PALANCA BASCULANTE ENTRE EJES 85 mm.

## SERIE 2K5 DUE

## CARACTERÍSTICAS

- Cerradura eléctrica 12V con apertura eléctrica automática con manilla o con cilindro
- Cerradura de 3 puntos con frente liso inox de 16 mm, 22 mm, 24 mm y U 24,5\*6
- Frente de 1850 mm de largo
- Sistema antitarjeta
- Compatible para CA y CC
- Mínimo esfuerzo para cierre de puerta
- Caja de 15 mm
- Cuadrado de 8 mm
- Escudo de seguridad pasante ref. BT1196/1N
- Cerraderos de serie según cerradura
- Tornillo de fijación de cilindro

## ACCESORIOS OPCIONALES

- Gama completa de cerraderos (ver páginas 44 - 51)
- Gama completa de cilindros (ver página 128 - 148)
- Frente de 2300 mm de largo opcional (serie 4K5)
- Frente de 1500 mm de largo opcional (serie 5K5)
- Conectores (ver página 56) CONECT01

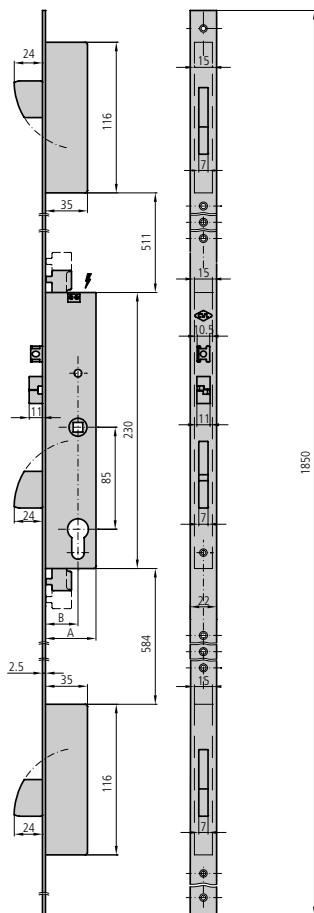

## DESCRIPCIÓN

## REF.

MEDIDAS  
B A

## LEVA

ACABADOS  
FRENTE CILINDRO

## UDS

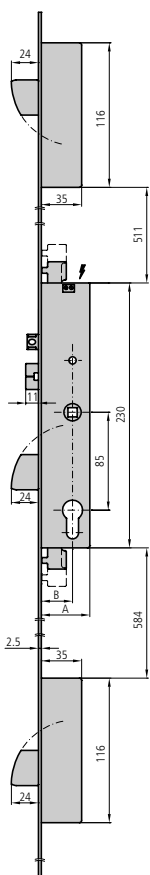

- Picaporte y palanca
- Cilindro no incluido
- Incluye cerradero ref. KCE1K5/6L
- 2 unidades alto/bajo: CE296S/6L

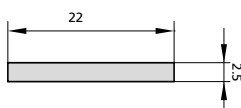

2K5/30/6L	27	42	15	Al	1
2K5/33/6L	30	43	13,25	Al	1
2K5/35/6L	32	47	15	Al	1

\* Otras medidas de frente consultar.



## PALANCA BASCULANTE ENTRE EJES 85 mm.

## SERIE 1K5 DUE

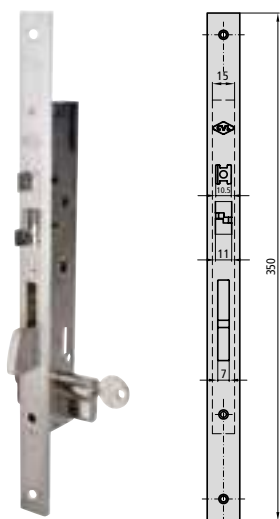

### CARACTERÍSTICAS

- Cerradura eléctrica 12V con apertura eléctrica automática con manilla o con cilindro
- Sistema antitarjeta
- Compatible para CA y CC
- Mínimo esfuerzo para cierre de puerta
- Caja de 15 mm
- Cuadradillo de 8 mm
- 2 escudos de nylon ref. E51984
- Cerraderos de serie según cerradura
- Tornillo de fijación de cilindro
- 2 terminales de frente de nylon ref. EMB196 para frente liso (para frente de 22 mm.)

### ACCESORIOS OPCIONALES

- Gama completa de cerraderos (ver páginas 44 - 51)
- Gama completa de cilindros (ver página 128 - 148)
- Conectores (ver página 56) CONECT01

DESCRIPCIÓN	REF.	MEDIDAS		LEVA	ACABADOS		UDS	
		B	A		FRENTE	CILINDRO		

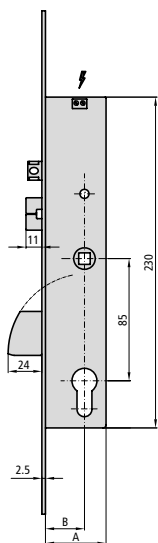

- Picaporte y palanca
- Cilindro no incluido
- Incluye cerradero Ref. KCE1K5/6L

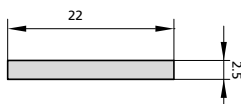

1K5/30/6	27	42	15	Al	1
1K5/33/6	30	43	13,25	Al	1
1K5/35/6	32	47	15	Al	1

\* Otras medidas de frente consultar.

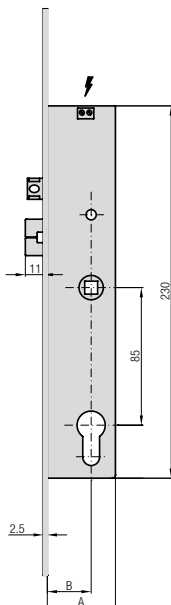

- Sólo picaporte
- Cilindro no incluido
- Incluye cerradero Ref. KCE1K5T/6L

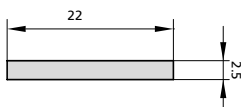

1K5T30/6	27	42	15	Al	1
1K5T33/6	30	43	13,25	Al	1
1K5T35/6	32	47	15	Al	1

\* Otras medidas de frente consultar.

## PUERTAS BATIENTES

## MULTIPUNTO PALANCA DESLIZANTE ENTRE EJES 92 mm.

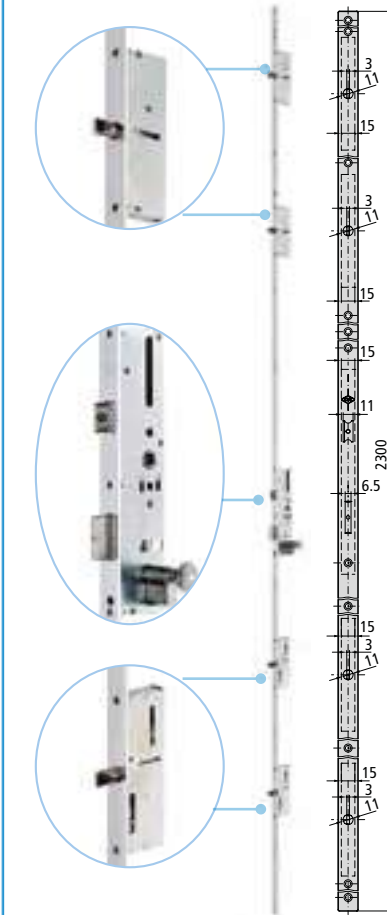
SERIE 4I25 **inve@se**

## CARACTERÍSTICAS

- Cerradura de 5 puntos con facilidad de cierre mediante manilla hacia arriba y bloqueo mediante llave
  - Frente liso inox de 22 mm
  - Frente de 2300 mm de largo
  - Picaporte de 11 mm reversible y regulable
  - Palanca central deslizante reforzada
  - Puntos alto y bajo con bulón
  - Caja cerrada de 15 mm
  - Cuadradillo de 8 mm
- Tornillo de fijación de cilindro

## ACCESORIOS OPCIONALES

- Gama completa de cerraderos (ver páginas 44 - 51)
- Gama completa de cilindros (ver página 128 - 148)
- Kit acople y punto de cierre adicional (ver página 10)

## DESCRIPCIÓN

## REF.

## MEDIDAS

## LEVA

## ACABADOS

## UDS

B A

FRENTE CILINDRO

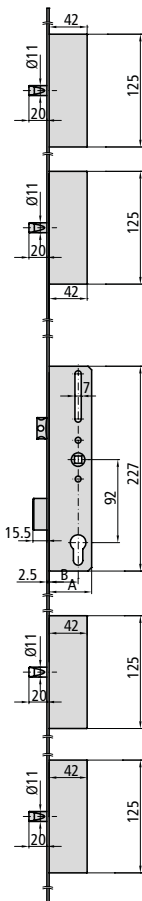
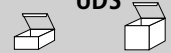

- Picaporte y palanca
- Cilindro no incluido

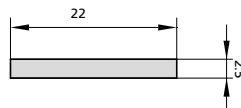
Opciones de cerradero  
(ver páginas 44 - 51)

4I25/30/6L	27	42	15	Al	1
4I25/33/6L	30	45	15	Al	1
4I25/35/6L	32	47	15	Al	1

MULTIPUNTO PALANCA DESLIZANTE ENTRE EJES 92 mm.

SERIE 2I2GB **inve@se**

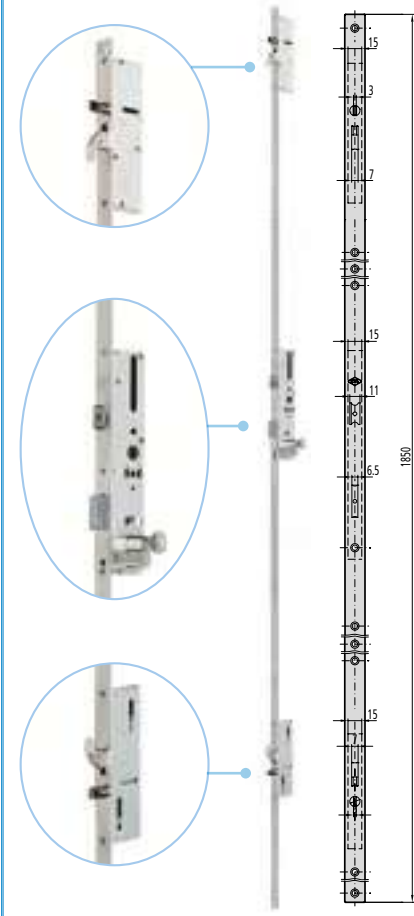

CARACTERÍSTICAS

- Cerradura multipunto con facilidad de cierre mediante manilla hacia arriba y bloqueo mediante llave
- Frente liso inox de 16 mm, 22 mm, 24 mm y U 24,5\*6
- Frente de 1850 mm de largo
- Picaporte de 11 mm reversible y regulable
- Palanca central deslizante reforzada
- Punto alto y bajo con gancho y bulón
- Caja cerrada de 15 mm
- Cuadradillo de 8 mm
- Tornillo de fijación de cilindro

ACCESORIOS OPCIONALES

- Gama completa de cerraderos (ver páginas 44 - 51)
- Gama completa de cilindros (ver página 128 - 148)
- Frente de 2300 mm de largo opcional (serie 4I2GB)
- Frente de 1500 mm de largo opcional (serie 5I2GB)

DESCRIPCIÓN	REF.	MEDIDAS		LEVA	ACABADOS		UDS	
		B	A		FRENTE	CILINDRO		

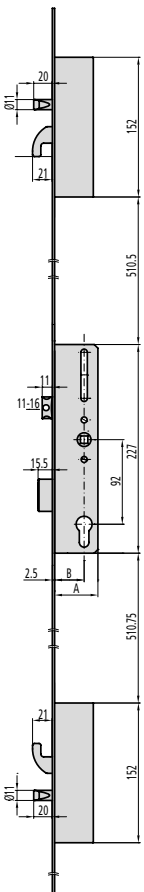

- Picaporte y palanca
- Cilindro no incluido

Opciones de cerradero (ver páginas 44 - 51)

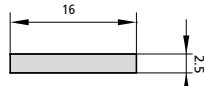

P2I2GB30/6	27	42	15	Al	1
P2I2GB33/6	30	45	15	Al	1
P2I2GB35/6	32	47	15	Al	1

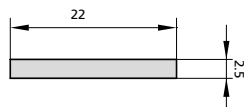

2I2GB30/6L	27	42	15	Al	1
2I2GB33/6L	30	45	15	Al	1
2I2GB35/6L	32	47	15	Al	1

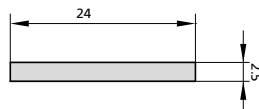

2I2GB30/6LAN	27	42	15	Al	1
2I2GB33/6LAN	30	45	15	Al	1
2I2GB35/6LAN	32	47	15	Al	1

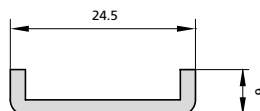

2I2GB30/6U	23	38	15	Al	1
2I2GB33/6U	26	41	15	Al	1
2I2GB35/6U	28	43	15	Al	1

## PUERTAS BATIENTES

## MULTIPUNTO PALANCA DESLIZANTE ENTRE EJES 92 mm.

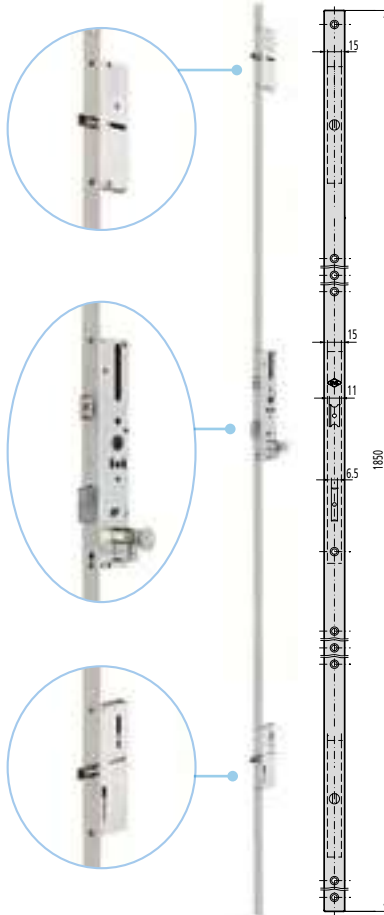
SERIE 2I2 **inve<sup>®</sup>se**

## CARACTERÍSTICAS

- Cerradura de 3 puntos con facilidad de cierre mediante manilla hacia arriba y bloqueo mediante llave
- Frente liso inox de 16 mm, 22 mm, 24 mm y U 24,5\*6
- Frente de 1850 mm de largo
- Picaporte de 11 mm reversible y regulable
- Palanca central deslizante reforzada
- Caja cerrada de 15 mm
- Cuadradillo de 8 mm
- Tornillo de fijación de cilindro

## ACCESORIOS OPCIONALES

- Gama completa de cerraderos (ver páginas 44 - 51)
- Gama completa de cilindros (ver página 128 - 148)
- Frente de 2300 mm de largo opcional (serie 4I2)
- Frente de 1500 mm de largo opcional (serie 5I2)

## DESCRIPCIÓN

## REF.

MEDIDAS  
B A

## LEVA

ACABADOS  
FRENTE CILINDRO

## UDS

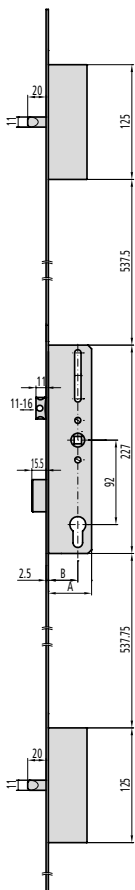
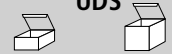

- Picaporte y palanca
- Cilindro no incluido

**Opciones de cerradero**  
(ver páginas 44 - 51)



P2I2/30/6	27	42	15	Al	1
P2I2/33/6	30	45	15	Al	1
P2I2/35/6	32	47	15	Al	1

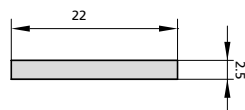

2I2/30/6L	27	42	15	Al	1
2I2/33/6L	30	45	15	Al	1
2I2/35/6L	32	47	15	Al	1

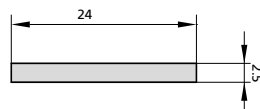

2I2/30/6LAN	27	42	15	Al	1
2I2/33/6LAN	30	45	15	Al	1
2I2/35/6LAN	32	47	15	Al	1

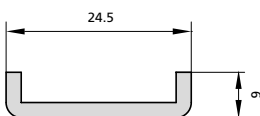

2I2/30/6U	23	38	15	Al	1
2I2/33/6U	26	41	15	Al	1
2I2/35/6U	28	43	15	Al	1

MULTIPUNTO PALANCA DESLIZANTE

SERIE 3I2, 3I5 **inve@se**

CARACTERÍSTICAS

- Cerradura multipunto central y alto/bajo con facilidad de cierre mediante manilla hacia arriba y bloqueo mediante llave
- Frente liso inox de 22 mm, 24 mm y U 24,5\*6
- Frente de 311 mm de largo
- Picaorte de 11 mm reversible y regulable
- Palanca central deslizante reforzada
- Caja cerrada de 15 mm
- Cuadradillo de 8 mm
- Entre ejes 85 mm (3I5) ó 92 mm (3I2)
- 2 escudos de nylon ref. ES1984
- Tornillo de fijación de cilindro

ACCESORIOS OPCIONALES

- Gama completa de cerraderos (ver páginas 44 - 51)
- Gama completa de cilindros (ver página 128 - 148)
- Accesorios 3I2 (ver página 52-55)

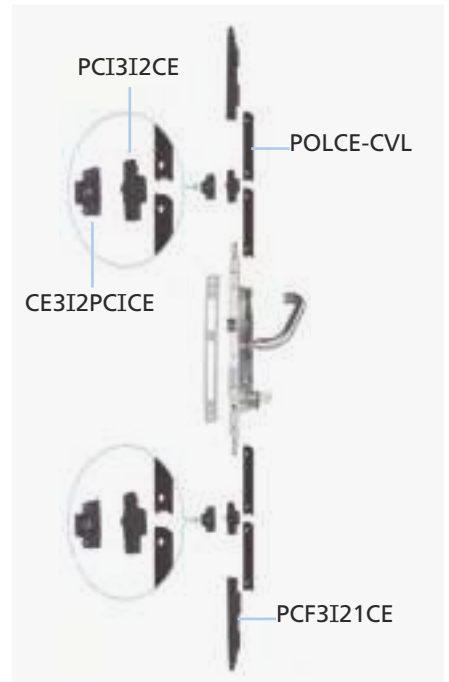
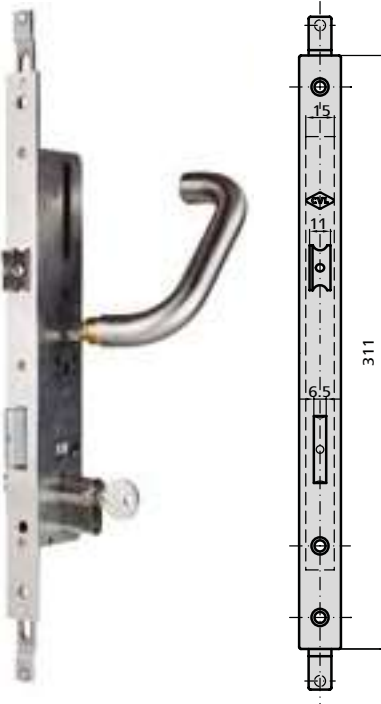

DESCRIPCIÓN

REF.

MEDIDAS  
B A

LEVA

ACABADOS  
FRENTES CILINDRO

UDS

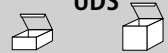

- Picaorte y palanca
- Cilindro no incluido

Opciones de cerradero  
(ver páginas 44 - 51)

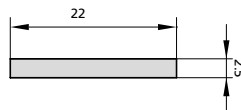

3I2/30/6L	27	42	15	Al	1	10
3I2/33/6L	30	45	15	Al	1	10
3I2/35/6L	32	47	15	Al	1	10
3I5/30/6L	27	42	15	Al	1	10
3I5/33/6L	30	45	15	Al	1	10
3I5/35/6L	32	47	15	Al	1	10

\* Otras medidas de frente consultar.

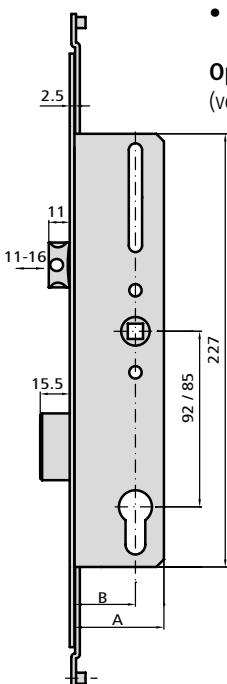

# PUERTAS BATIENTES

## CERRADURA ANTIPÁNICO PALANCA DESLIZANTE

## SERIES 615, 612

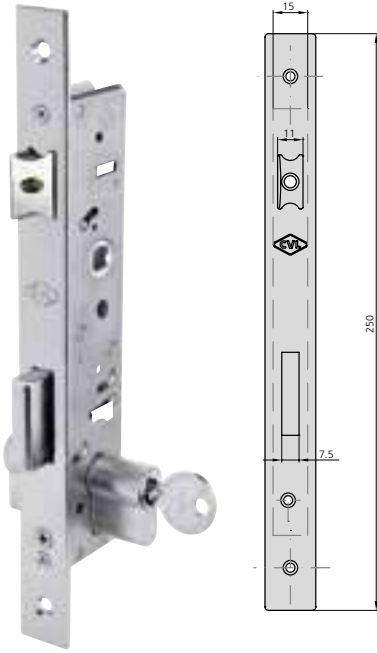

### CARACTERÍSTICAS

- Cerradura con función antipánico para puertas de aluminio y metálicas
- Sistema antipánico reversible
- Frente inox. de 22 mm
- Picaporte reversible de 11 mm
- Picaporte regulable, excepto en entrada de 25 mm
- Caja de 15 mm
- Cuadradillo de 8 mm
- **Operado mediante llave y pomo o manilla desde el exterior**
- Tornillo de fijación de cilindro
- Entre ejes 85 mm (615) ó 92 mm (612)

### ACCESORIOS OPCIONALES

- Gama completa de cerraderos (ver páginas 44 - 51)
- Gama completa de cilindros (ver página 128 - 148)

### DESCRIPCIÓN

### REF.

### MEDIDAS B A

### LEVA

### ACABADOS FRENTE CILINDRO

### UDS

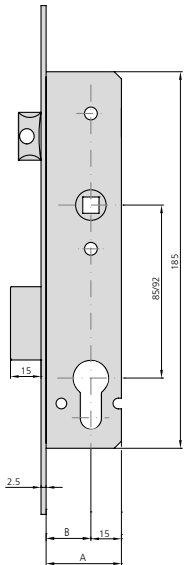
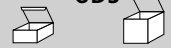

- Picaporte y palanca
- Cilindro no incluido
- Cerradura con nueca partida
- Opciones de cerradero (ver páginas 44-51)
- Opciones de cerradero eléctrico (ver página 52)

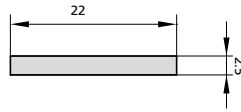

615/25/6	22	37	15	Al	1	20
615/30/6	27	42	15	Al	1	20
615/35/6	32	47	15	Al	1	20
612/25/6	22	37	15	Al	1	20
612/30/6	27	42	15	Al	1	20
612/35/6	32	47	15	Al	1	20



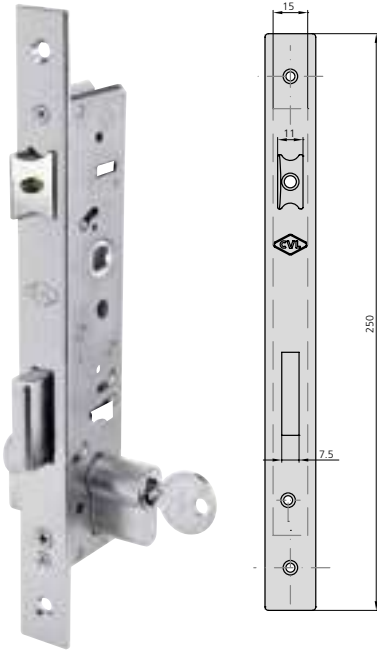

**CARACTERÍSTICAS**

- Cerradura con función antipánico para puertas de aluminio y metálicas
- Sistema antipánico reversible
- Frente inox de 22 mm
- Picaporte reversible de 11 mm
- Picaporte regulable, excepto en entrada de 25 mm
- Caja de 15 mm
- Cuadradillo de 8 mm
- Operado mediante llave y manilla desde el exterior. La llave bloquea o desbloquea la manilla
- Tornillo de fijación de cilindro
- Entre ejes 85 mm (615E) ó 92 mm (612E)

**ACCESORIOS OPCIONALES**

- Gama completa de cerraderos (ver páginas 44 - 51)
- Gama completa de cilindros (ver página 128 - 148)

**DESCRIPCIÓN**

**REF.**

**MEDIDAS**  
B A

**LEVA**

**ACABADOS**  
FRENTES CILINDRO

**UDS**



- Picaporte y palanca
- Cilindro no incluido

- Opciones de cerradero (ver páginas 44-51)
- Opciones de cerradero eléctrico (ver página 52)

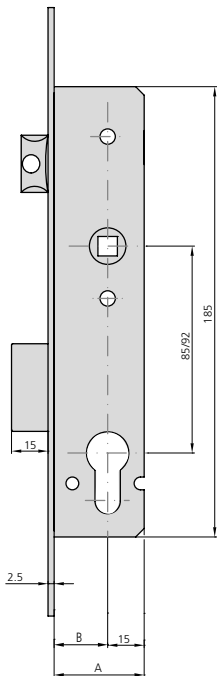
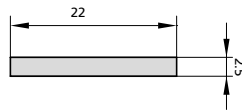

615E/25/6	22	37	15	Al	1	20
615E/30/6	27	42	15	Al	1	20
615E/35/6	32	47	15	Al	1	20
612E/25/6	22	37	15	Al	1	20
612E/30/6	27	42	15	Al	1	20
612E/35/6	32	47	15	Al	1	20

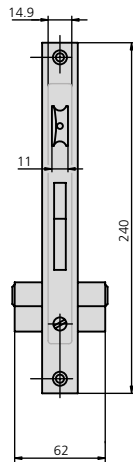

## CARACTERÍSTICAS

- Cerradura cortafuego para puertas de aluminio
- Frente liso inox de 22 mm
- Picaporte de acero reversible de 11 mm
- Picaporte regulable excepto en entrada 25 mm
- Caja de 15 mm
- Cuadradillo de 8 mm
- 2 escudos de nylon ref. ES1984
- Tornillo de fijación de cilindro

## ACCESORIOS OPCIONALES

- Gama completa de cerraderos (ver páginas 44 - 51)
- Gama completa de cilindros (ver página 128 - 148)
- Escudo de seguridad pasante BT1296 (ver página 56)

## DESCRIPCIÓN

## REF.

MEDIDAS  
B A

## LEVA

ACABADOS  
FRENTE CILINDRO

## UDS

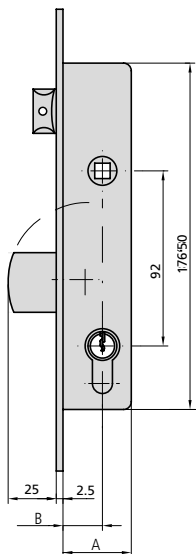
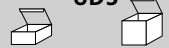

- Picaporte y palanca
- No incluye cilindro

**Opciones de cerradero**  
(ver páginas 44 - 51)

**Opción de cerradero eléctrico**  
(ver página 52)

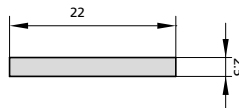

194F/30/6SC	27	42	15	AI	CN	1	20
194F/35/6SC	32	47	15	AI	CN	1	20

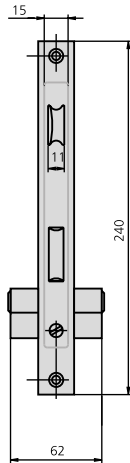
**PUERTAS BATIENTES**
**PALANCA DESLIZANTE ENTRE EJES 85 mm.**
**SERIE 184**

**CARACTERÍSTICAS**

- Frente de 22 mm ó 24 mm
- Picaporte reversible de 11 mm
- Caja de 15 mm
- Cuadrado de 8 mm
- 2 escudos de nylon ref. ES1984
- 2 terminales de frente de nylon ref. EMB196 (para frente de 22 mm)
- Tornillo de fijación de cilindro
- Según norma UNE-EN 12209:2004

**ACCESORIOS OPCIONALES**

- Gama completa de cerraderos (ver páginas 44 - 51)
- Gama completa de cilindros (ver página 128 - 148)
- Kit para adaptación a condensa (ver página 167)

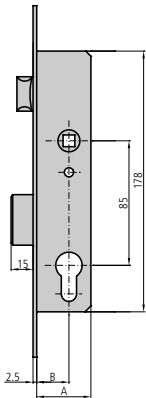
DESCRIPCIÓN	REF.	MEDIDAS		LEVA	ACABADOS		UDS	
		B	A		FRENTE	CILINDRO		



- Picaporte y palanca
- Cilindros de leva larga 5982/2525/4 o de leva corta 5990/2525/4

**Opciones de cerradero**  
(ver páginas 44 - 51)

**Opción cerraderos eléctricos**  
(ver página 52)

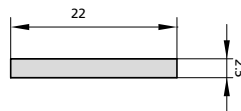

184/21/0	18	31	13,25	HN	CN	1	20
184/21/6D	18	31	15	Al	CN	1	20
184/23/0	20	33	13,25	HN	CN	1	20
184/23/6	20	33	13,25	Al	CN	1	20
184/25/0	22	37	15	HN	CN	1	20
184/25/6	22	37	15	Al	CN	1	20
184/28/0	25	38	13,25	HN	CN	1	20
184/28/6	25	38	13,25	Al	CN	1	20
184/30/0	27	42	15	HN	CN	1	20
184/30/6	27	42	15	Al	CN	1	20
184/33/0	30	43	13,25	HN	CN	1	20
184/33/6	30	43	13,25	Al	CN	1	20
184/35/0	32	47	15	HN	CN	1	20
184/35/6	32	47	15	Al	CN	1	20

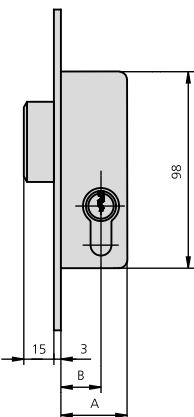

- Sólo palanca
- Cilindros de leva larga 5982/2525/4 o de leva corta 5990/2525/4

**Opciones de cerradero**  
(ver páginas 44 - 51)

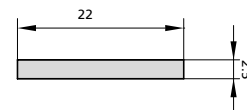



184A23/6	20	33	13,25	Al	CN	1	30
184A25/6	22	37	15	Al	CN	1	30
184A28/6	25	38	13,25	Al	CN	1	30
184A30/6	27	42	15	Al	CN	1	30
184A33/6	30	43	13,25	Al	CN	1	30
184A35/6	32	47	15	Al	CN	1	30

## PUERTAS BATIENTES

## PALANCA DESLIZANTE ENTRE EJES 85 mm.

## SERIE 184

DESCRIPCIÓN	REF.	MEDIDAS		LEVA	ACABADOS		UDS	
		B	A		FRENTE	CILINDRO		

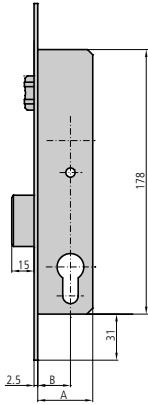
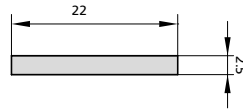

• Rodillo vaivén regulable y palanca	184V23/6	20	33	13,25	Al	CN	1	20
	184V25/6	22	37	15	Al	CN	1	20
• Cilindros de leva larga 5982/2525/4 o de leva corta 5990/2525/4	184V28/6	25	38	13,25	Al	CN	1	20
	184V30/6	27	42	15	Al	CN	1	20
	184V33/6	30	43	13,25	Al	CN	1	20
<b>Opciones de cerradero</b> (ver páginas 44 - 51)	184V35/6	32	47	15	Al	CN	1	20

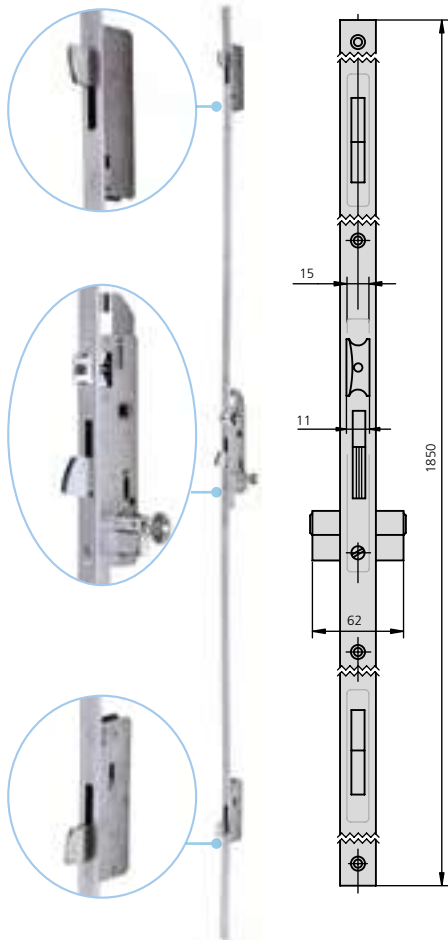
**MULTIPUNTO PALANCA BASCULANTE ENTRE EJES 85 mm.**
**SERIE 296**

**CARACTERÍSTICAS**

- Frente liso inox de 1850x22 mm o 1850x24 mm o frente U 1850x24,5x6
- Picaporte reversible de 11 mm
- Picaporte regulable excepto en entrada 25 mm y 28 mm
- Caja de 15 mm
- Cuadradillo de 8 mm
- Tornillo de fijación de cilindro

**ACCESORIOS OPCIONALES**

- Gama completa de cerraderos (ver páginas 44 - 51)
- Gama completa de cilindros (ver página 128 - 148)
- Frente de 2300 mm de largo opcional (serie 496)
- Frente de 1500 mm de largo opcional (serie 596)

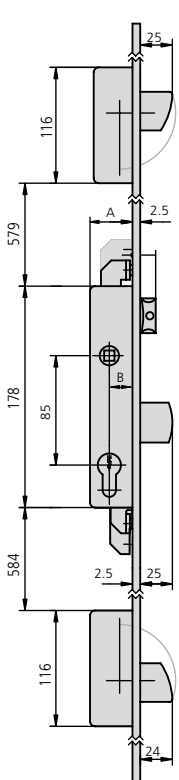
DESCRIPCIÓN	REF.	MEDIDAS		LEVA	ACABADOS		UDS	
		B	A		FRENTE	CILINDRO		



- Picaporte y palanca
- Cilindro no incluido

**Opciones de cerradero**  
(ver páginas 44 - 51)

**Opción cerradero eléctrico**  
(ver página 52)

296/25/6L	22	37	15	Al	1
296/28/6L	25	38	13,25	Al	1
296/30/6L	27	42	15	Al	1
296/33/6L	30	43	13,25	Al	1
296/35/6L	32	47	15	Al	1
296/38/6L	35	48	13,25	Al	1
296/25/6LAN	22	37	15	Al	1
296/28/6LAN	25	38	13,25	Al	1
296/30/6LAN	27	42	15	Al	1
296/33/6LAN	30	43	13,25	Al	1
296/35/6LAN	32	47	15	Al	1
296/38/6LAN	35	48	13,25	Al	1
296/25/6U	18	33	15	Al	1
296/28/6U	21	34	13,25	Al	1
296/30/6U	23	38	15	Al	1
296/33/6U	26	39	13,25	Al	1
296/35/6U	28	43	15	Al	1

## PUERTAS BATIENTES

## MULTIPUNTO PALANCA BASCULANTE ENTRE EJES 85 mm.

## SERIE 296

DESCRIPCIÓN	REF.	MEDIDAS		LEVA	ACABADOS		UDS
		B	A		FRENTE	CILINDRO	
	296A25/6L	22	37	15	Al		1
	296A28/6L	25	38	13,25	Al		1
	296A30/6L	27	42	15	Al		1
	296A33/6L	30	43	13,25	Al		1
	296A35/6L	32	47	15	Al		1
	296A38/6L	35	48	13,25	Al		1
	296A25/6LAN	22	37	15	Al		1
	296A28/6LAN	25	38	13,25	Al		1
	296A30/6LAN	27	42	15	Al		1
	296A33/6LAN	30	43	13,25	Al		1
	296A35/6LAN	32	47	15	Al		1
	296A38/6LAN	35	48	13,25	Al		1
	296A25/6U	18	33	15	Al		1
	296A30/6U	23	38	15	Al		1
	296A35/6U	28	43	15	Al		1

• Sólo palanca  
 • Cilindro no incluido  
**Opciones de cerradero**  
 (ver páginas 44 - 51)

	296V25/6L	22	37	15	Al		1
	296V28/6L	25	38	13,25	Al		1
	296V30/6L	27	42	15	Al		1
	296V33/6L	30	43	13,25	Al		1
	296V35/6L	32	47	15	Al		1
	296V38/6L	35	48	13,25	Al		1
	296V25/6LAN	22	37	15	Al		1
	296V28/6LAN	25	38	13,25	Al		1
	296V30/6LAN	27	42	15	Al		1
	296V33/6LAN	30	43	13,25	Al		1
	296V35/6LAN	32	47	15	Al		1
	296V38/6LAN	35	48	13,25	Al		1
	296V25/6U	18	33	15	Al		1
	296V30/6U	23	38	15	Al		1
	296V35/6U	28	43	15	Al		1

• Rodillo vaivén regulable y palanca  
 • Cilindro no incluido  
**Opciones de cerradero**  
 (ver páginas 44 - 51)

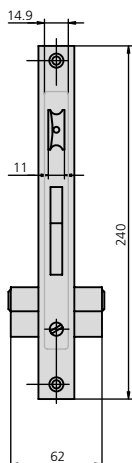
**PUERTAS BATIENTES**
**PALANCA BASCULANTE ENTRE EJES 85 mm.**
**SERIE 196**

**CARACTERÍSTICAS**

- Frente inox de 22 mm o 24 mm o frente U de 24,5 x 6
- Picaporte reversible de 11 mm
- Picaporte regulable excepto en entrada 25 mm y 28 mm
- Caja de 15 mm
- Cuadradillo de 8 mm
- 2 escudos de nylon ref. ES1984
- 2 terminales de frente de nylon ref. EMB196 (para frente de 22 mm)
- Tornillo de fijación de cilindro

**ACCESORIOS OPCIONALES**

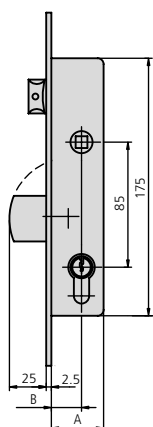
- Gama completa de cerraderos (ver páginas 44 - 51)
- Gama completa de cerraderos (ver página 128 - 148)
- Escudo de seguridad pasante BTI296/1N (ver página 56)
- Kit para adaptación a condensa (ver página 167)

**DESCRIPCIÓN**
**REF.**
**MEDIDAS**
**LEVA**
**ACABADOS**
**UDS**
**B A**
**FRENTE CILINDRO**

- Picaporte y palanca
- Cilindro de leva larga 5982/2525/4 o de leva corta 5990/2525/4

**Opciones de cerradero**  
(ver páginas 44 - 51)

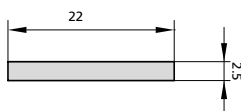
**Opción cerradero eléctrico**  
(ver página 52)

196/25/6	22	37	15	AI	CN	1	20
196/28/6	25	38	13,25	AI	CN	1	20
196/30/6	27	42	15	AI	CN	1	20
196/33/6	30	43	13,25	AI	CN	1	20
196/35/6	32	47	15	AI	CN	1	20
196/38/6	35	48	13,25	AI	CN	1	20

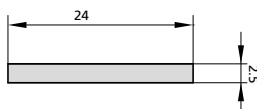

196/25/6AN	22	37	15	AI	CN	1	20
196/28/6AN	25	38	13,25	AI	CN	1	20
196/30/6AN	27	42	15	AI	CN	1	20
196/33/6AN	30	43	13,25	AI	CN	1	20
196/35/6AN	32	47	15	AI	CN	1	20
196/38/6AN	35	48	13,25	AI	CN	1	20

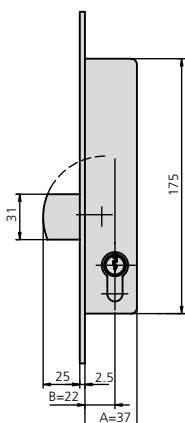

- Sólo palanca
- Cilindro de leva larga 5982/2525/4 o de leva corta 5990/2525/4

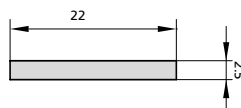

**Opciones de cerradero**  
(ver páginas 44 - 51)

196A25/6	22	37	15	AI	CN	1	20
196A28/6	25	38	13,25	AI	CN	1	20
196A30/6	27	42	15	AI	CN	1	20
196A33/6	30	43	13,25	AI	CN	1	20
196A35/6	32	47	15	AI	CN	1	20
196A38/6	35	48	13,25	AI	CN	1	20

## PUERTAS BATIENTES

## PALANCA BASCULANTE ENTRE EJES 85 mm.

## SERIE 196

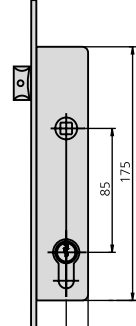
DESCRIPCIÓN	REF.	MEDIDAS		LEVA	ACABADOS		UDS	
		B	A		FRENTE	CILINDRO		
 <ul style="list-style-type: none"> <li>Sólo picaporte y medio cilindro</li> <li>Cilindro 5982T40/4</li> </ul> <p><b>Opción cerradero eléctrico</b> (ver página 52)</p>	196T23/6	20	33	13,25	Al	CN	1	20
	196T25/6	22	37	15	Al	CN	1	20
	196T28/6	25	38	13,25	Al	CN	1	20
	196T30/6	27	42	15	Al	CN	1	20
	196T33/6	30	43	13,25	Al	CN	1	20
	196T35/6	32	47	15	Al	CN	1	20
	196T38/6	35	48	13,25	Al	CN	1	20

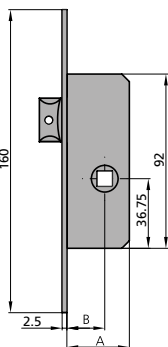
 <ul style="list-style-type: none"> <li>Sólo picaporte y sin cilindro</li> </ul> <p><b>Opciones de cerradero</b> (ver páginas 44 - 51)</p>	196R23/6	20	33		Al	CN	2	20
	196R25/6	22	37		Al	CN	2	20
	196R28/6	25	38		Al	CN	2	20
	196R30/6	27	42		Al	CN	2	20
	196R33/6	30	43		Al	CN	2	20
	196R35/6	32	47		Al	CN	2	20
	196R38/6	35	48		Al	CN	2	20

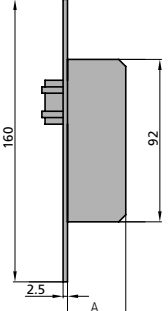
 <ul style="list-style-type: none"> <li>Sólo vaivén</li> </ul> <p><b>Opciones de cerradero</b> (ver páginas 44 - 51)</p>	196RV/6		33		Al	CN	2	20
---	---------	--	----	--	----	----	---	----

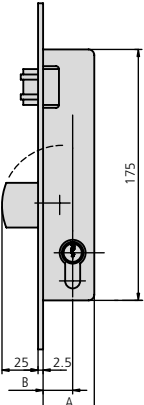
 <ul style="list-style-type: none"> <li>Rodillo vaivén regulable y palanca</li> <li>Cilindro de leva larga 5982/2525/4 o de leva corta 5990/2525/4</li> </ul> <p><b>Opciones de cerradero</b> (ver páginas 44 - 51)</p>	196V25/6	22	37	15	Al	CN	1	20
	196V28/6	25	38	13,25	Al	CN	1	20
	196V30/6	27	42	15	Al	CN	1	20
	196V33/6	30	43	13,25	Al	CN	1	20
	196V35/6	32	47	15	Al	CN	1	20
	196V38/6	35	48	13,25	Al	CN	1	20



**PALANCA GANCHO ENTRE EJES 85 mm.**

**SERIE 197**

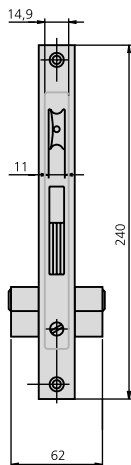

**CARACTERÍSTICAS**

- Frente inox de 22 mm
- Picaporte reversible de 11 mm
- Picaporte regulable excepto en entrada 25 mm y 28 mm
- Caja de 15 mm
- Cuadradillo de 8 mm
- 2 escudos de nylon ref. E51984
- 2 terminales de frente de nylon ref. EMB196 (para frente de 22 mm)
- Tornillo de fijación de cilindro

**ACCESORIOS OPCIONALES**

- Gama completa de cerraderos (ver páginas 44 - 51)
- Gama completa de cilindros (ver página 128 - 148)
- Escudo de seguridad pasante BTI296/1N (ver página 56)

DESCRIPCIÓN	REF.	MEDIDAS		LEVA	ACABADOS		UDS	
		B	A		FRENTE	CILINDRO		

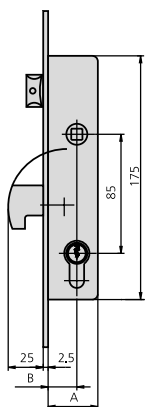

- Picaporte y palanca gancho
- Cilindro de leva larga 5982/2525/4 o de leva corta 5990/2525/4

**Opciones de cerradero**  
(ver páginas 44 - 51)

197/25/6	22	37	15	AI	CN	1	20
197/28/6	25	38	13,25	AI	CN	1	20
197/30/6	27	42	15	AI	CN	1	20
197/33/6	30	43	13,25	AI	CN	1	20
197/35/6	32	47	15	AI	CN	1	20
197/38/6	35	48	13,25	AI	CN	1	20

## PUERTAS BATIENTES

## PALANCA DESLIZANTE ENTRE EJES 92 mm.

## SERIE 192

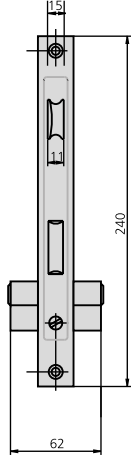

## CARACTERÍSTICAS

- Frente inox de 16 mm, 22 mm o 24 mm
- Picaporte reversible de 11 mm
- Caja de 15 mm
- Cuadradillo de 8 mm
- Según norma UNE-EN 12209:2004
- 2 escudos de nylon ref. ES1984
- Tornillo de fijación de cilindro

## ACCESORIOS OPCIONALES

- Gama completa de cerraderos (ver páginas 44 - 51)
- Gama completa de cilindros (ver página 128 - 148)
- Kit para adaptación a condensa (ver página 167)

## DESCRIPCIÓN

## REF.

MEDIDAS  
B A

## LEVA

ACABADOS  
FRENTE CILINDRO

## UDS

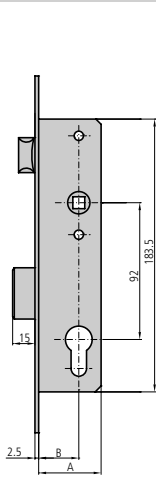
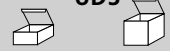

- Picaporte y palanca
- No incluye cilindro

Opciones de cerradero  
(ver páginas 44 - 51)Opción de cerradero  
eléctrico  
(ver página 52)

P192/25/6SC	22	37	15	AI	CN	1	20
P192/30/6SC	27	42	15	AI	CN	1	20
P192/35/6SC	32	47	15	AI	CN	1	20

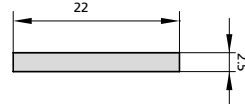

192/25/6SC	22	37	15	AI	CN	1	20
192/30/6SC	27	42	15	AI	CN	1	20
192/35/6SC	32	47	15	AI	CN	1	20

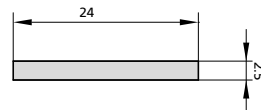

192/25/6ANSC	22	37	15	AI	CN	1	20
192/30/6ANSC	27	42	15	AI	CN	1	20
192/35/6ANSC	32	47	15	AI	CN	1	20

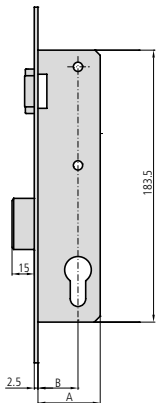

- Rodillo vaivén regulable y palanca
- No incluye cilindro

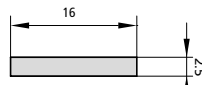
Opciones de cerradero  
(ver páginas 44 - 51)

P192V25/6SC	22	37	15	AI	CN	1	20
P192V30/6SC	27	42	15	AI	CN	1	20
P192V35/6SC	32	47	15	AI	CN	1	20

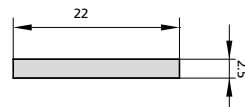

192V25/6SC	22	37	15	AI	CN	1	20
192V30/6SC	27	42	15	AI	CN	1	20
192V35/6SC	32	47	15	AI	CN	1	20

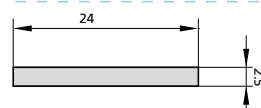

192V25/6ANSC	22	37	15	AI	CN	1	20
192V30/6ANSC	27	42	15	AI	CN	1	20
192V35/6ANSC	32	47	15	AI	CN	1	20

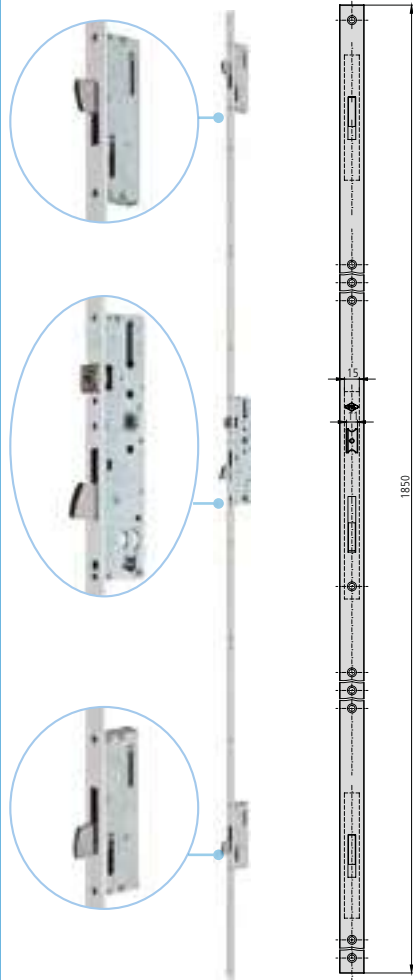
**PUERTAS BATIENTES**
**MULTIPUNTO PALANCA BASCULANTE ENTRE EJES 92 mm.**
**SERIE 294N**

**CARACTERÍSTICAS**

- Frente liso inox de 1850x22 mm o 1850x24 mm o frente U de 1850x24,5x6
- Picaporte reversible de 11 mm
- Picaporte regulable excepto en entrada 25 mm
- Caja de 15 mm
- Cuadradillo de 8 mm
- Tornillo de fijación de cilindro

**ACCESORIOS OPCIONALES**

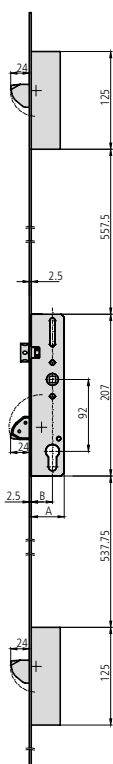
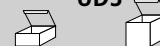
- Gama completa de cerraderos (ver páginas 44 - 51)
- Gama completa de cilindros (ver página 128 - 148)
- Frente de 2300 mm de largo opcional (serie 494N)
- Frente de 1500 mm de largo opcional (serie 594N)
- Kit vaivén para sustituir picaporte (ref. CV1E5) (ver página 56)

**DESCRIPCIÓN**
**REF.**
**MEDIDAS  
B A**
**LEVA**
**ACABADOS  
FRENTE CILINDRO**
**UDS**

- Picaporte y palanca
- Cilindro no incluido

**Opciones de cerradero**  
(ver páginas 44 - 51)

**Opción cerradero eléctrico**  
(ver página 52)

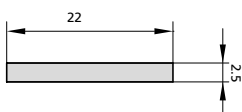

294N/30/6L	27	42	15	Al	1
294N/35/6L	32	47	15	Al	1

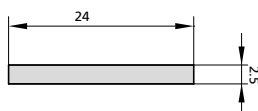

294N/30/6LAN	27	42	15	Al	1
294N/35/6LAN	32	47	15	Al	1

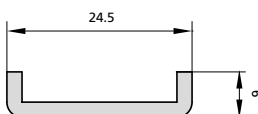

294N/30/6U	23	38	15	Al	1
294N/35/6U	28	43	15	Al	1

## PUERTAS BATIENTES

MULTIPUNTO PALANCA BASCULANTE ENTRE EJES 92 mm.

SERIE 294N

DESCRIPCIÓN	REF.	MEDIDAS		LEVA	ACABADOS		UDS
		B	A		FRENTE	CILINDRO	

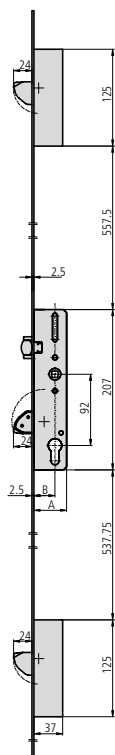

- Rodillo vaivén regulable de nylon y palanca
- Cilindro no incluido

**Opciones de cerradero**  
(ver páginas 44 - 51)

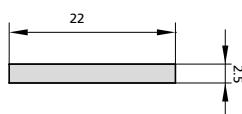

294NV30/6L	27	42	15	Al	1
294NV35/6L	32	47	15	Al	1

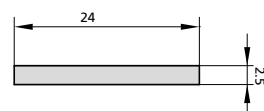

294NV30/6LAN	27	42	15	Al	1
294NV35/6LAN	32	47	15	Al	1

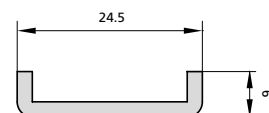

294NV30/6U	23	38	15	Al	1
294NV35/6U	28	43	15	Al	1

PALANCA BASCULANTE ENTRE EJES 92 mm.

SERIE 194

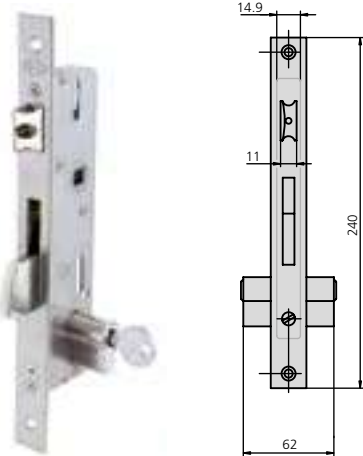

CARACTERÍSTICAS

- Frente liso inox de 22 mm o 24 mm ó frente inox en U de 24,5x6
- Picaporte reversible de 11 mm
- Picaporte regulable excepto en entrada 25 mm
- Caja de 15 mm
- Cuadradillo de 8 mm
- 2 escudos de nylon ref. ES1984
- Tornillo de fijación de cilindro

ACCESORIOS OPCIONALES

- Gama completa de cerraderos (ver páginas 44 - 51)
- Gama completa de cilindros (ver página 128 - 148)
- Escudo de seguridad pasante BTI296 (ver página 56)
- Kit para adaptación a condensa (ver página 167)

DESCRIPCIÓN	REF.	MEDIDAS		LEVA	ACABADOS		UDS	
		B	A		FRENTE	CILINDRO		

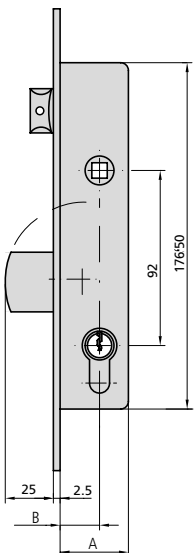

- Picaporte y palanca
- No incluye cilindro

**Opciones de cerradero**  
(ver páginas 44 - 51)

**Opción de cerradero eléctrico**  
(ver página 52)



194/25/6SC	22	37	15	Al	CN	1	20
194/30/6SC	27	42	15	Al	CN	1	20
194/35/6SC	32	47	15	Al	CN	1	20

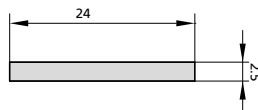

194/25/6ANSC	22	37	15	Al	CN	1	20
194/30/6ANSC	27	42	15	Al	CN	1	20
194/35/6ANSC	32	47	15	Al	CN	1	20

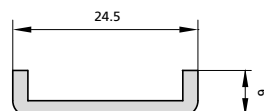

194/25/6USC	18	33	15	Al U	CN	1	20
194/30/6USC	23	38	15	Al U	CN	1	20
194/35/6USC	28	43	15	Al U	CN	1	20

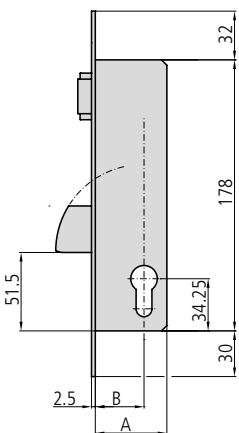

- Rodillo vaivén regulable y palanca.
- No incluye cilindro

**Opciones de cerradero**  
(ver páginas 44 - 51)

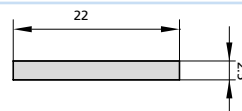

194RV25/6SC	22	37	15	Al	CN	1	20
194RV30/6SC	27	42	15	Al	CN	1	20
194RV35/6SC	32	47	15	Al	CN	1	20

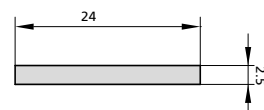

194RV25/6ANSC	22	37	15	Al	CN	1	20
194RV30/6ANSC	27	42	15	Al	CN	1	20
194RV35/6ANSC	32	47	15	Al	CN	1	20

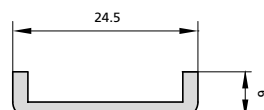

194RV25/6USC	18	33	15	Al U	CN	1	20
194RV30/6USC	23	38	15	Al U	CN	1	20
194RV35/6USC	28	43	15	Al U	CN	1	20

## PUERTAS BATIENTES

## ACCESORIOS

## CERRADEROS

UDS



DESCRIPCIÓN

REF.

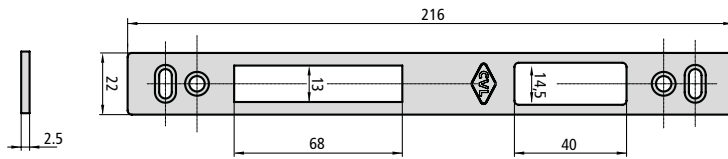
APLICABLE A  
CERRADURAS

- Cerradero fijo de hierro niquelado CE184/0L
- Cerradero fijo de acero inoxidable CE184/6L

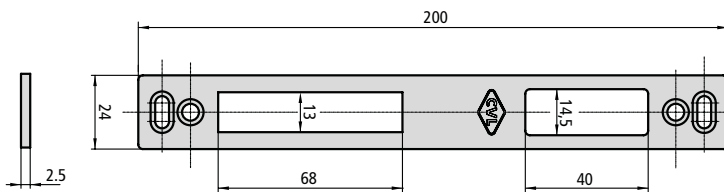

- Cerradero fijo de hierro niquelado CE184/0LAN
- Cerradero fijo de acero inoxidable CE184/6LAN

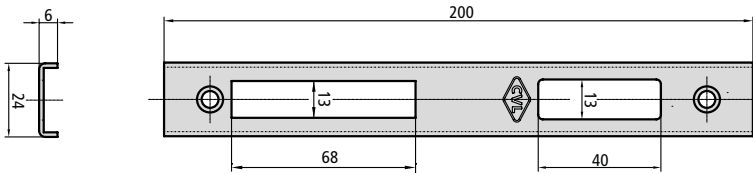

- Cerradero fijo de acero inoxidable CE184/6U

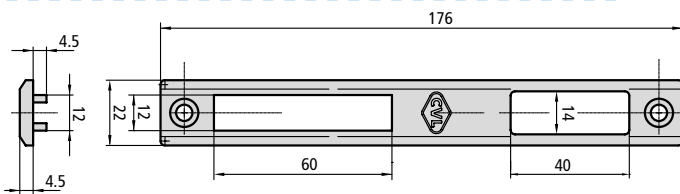

- Cerradero fijo metálico negro CE184/1N

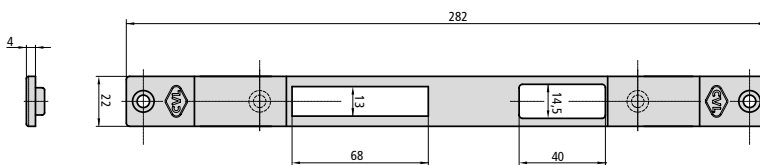

- Cerradero regulable metálico negro CE184/1NR

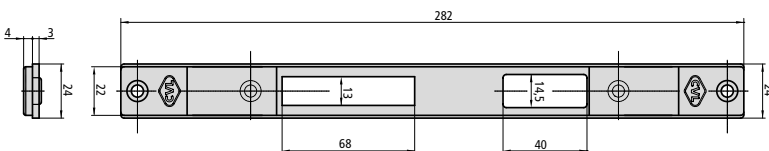

- Cerradero regulable metálico negro con suplemento CE184/1NRS

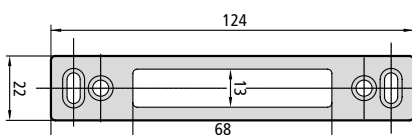

- Cerradero fijo de acero inoxidable CE184A/6L

184, 184C, 184V,  
192, 192C, 192V, 1E5,  
central 2E5, 1E2,  
central 2E2, 2E2GB,  
615, 615E,  
2I2, 2I2GB, 3I2,  
2A2 central

184A

**PUERTAS BATIENTES**
**ACCESORIOS**
**CERRADEROS**

DESCRIPCIÓN	REF.	APLICABLE A CERRADURAS	UDS 	PRECIO COMPLETA S/CILINDRO
	CE196/6L			
<ul style="list-style-type: none"> <li>• Cerradero fijo de acero inoxidable</li> </ul>				
	CE196/6LAN			
<ul style="list-style-type: none"> <li>• Cerradero fijo de acero inoxidable</li> </ul>				
	CE196/6U			
<ul style="list-style-type: none"> <li>• Cerradero fijo de acero inoxidable con levas</li> </ul>				
	CE196/6LR			
<ul style="list-style-type: none"> <li>• Cerradero regulable de acero inoxidable con levas</li> </ul>				
	CE196/1N			
<ul style="list-style-type: none"> <li>• Cerradero fijo metálico negro</li> </ul>				

196, 196C, 196V, 197, 194, 194C, 194F, 194V, central 296, 296V, 396, 496, 496V, 596, 596V, 294N, 294NV, 494N, 494NV

## PUERTAS BATIENTES

## ACCESORIOS

## CERRADEROS

UDS



DESCRIPCIÓN

REF.

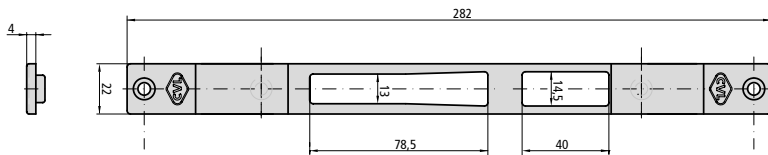
APLICABLE A  
CERRADURAS

- Cerradero regulable metálico negro CE196/1NR

196, 196C, 196V, 197,  
194, 194C, 194F, 194V,  
central 296, 296V, 396,  
496, 496V, 596, 596V,  
294N, 294NV, 494N,  
494NV

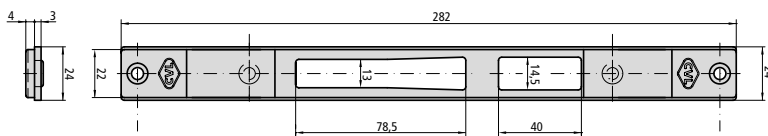

- Cerradero regulable metálico negro con suplemento CE196/1NRS

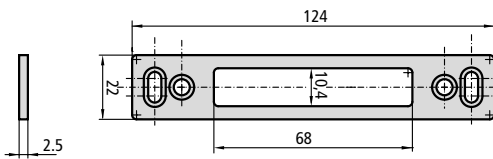

- Cerradero fijo de acero inoxidable para solo palanca CE296S/6L

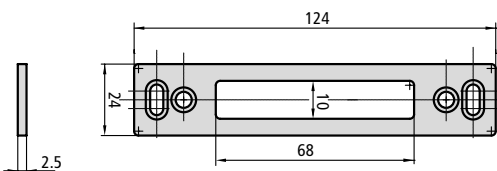

- Cerradero fijo de acero inoxidable para solo palanca CE296S/6LAN

196A, 296A, 496A,  
596A, 294A, 494A,  
suplementos alto/bajo de  
las series 296, 496, 596,  
294N, 494N, 2E5, 2E2,  
2K2, 2K5

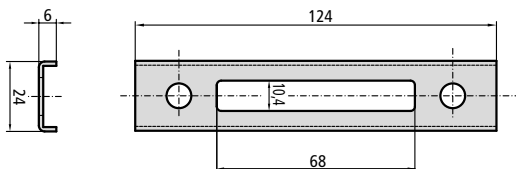

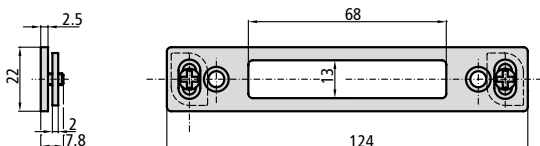

- Cerradero fijo de acero inoxidable para solo palanca CE296S/6U



- Cerradero regulable de acero inoxidable con levas CE296S/6LR



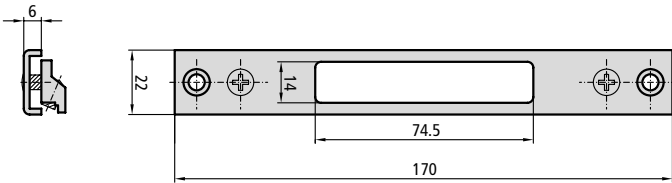
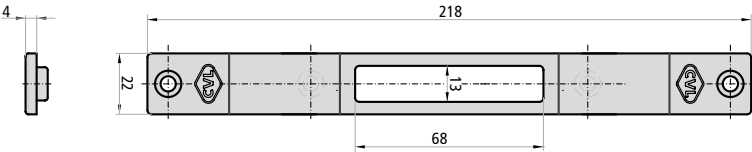
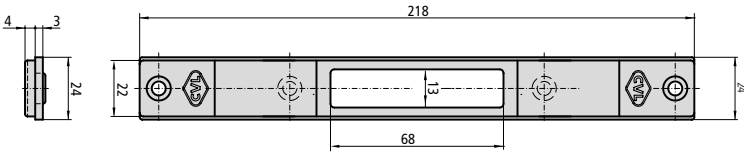
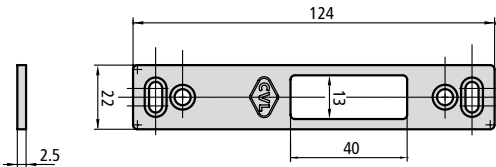
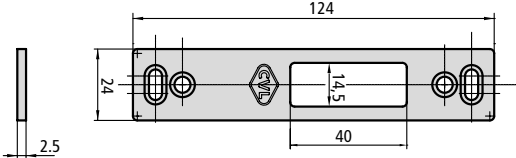
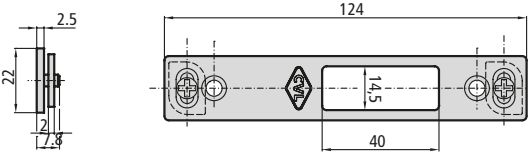

**PUERTAS BATIENTES**
**ACCESORIOS**
**CERRADEROS**



DESCRIPCIÓN	REF.	APLICABLE A CERRADURAS	UDS  
	CE296S/6RU		
<ul style="list-style-type: none"> <li>Cerradero regulable inox en U solo palanca</li> </ul>			
	CE296S/1NR	196A, 296A, 496A, 596A, 294A, 494A, suplementos alto/bajo de las series 296, 496, 596, 294N, 494N, 2E5, 2E2, 2K2 2K5	
<ul style="list-style-type: none"> <li>Cerradero regulable metálico negro</li> </ul>			
	CE296S/1NRS		
<ul style="list-style-type: none"> <li>Cerradero regulable metálico negro con suplemento</li> </ul>			
	CE196R/6L		
<ul style="list-style-type: none"> <li>Cerradero fijo de acero inoxidable para solo picaporte</li> </ul>			
	CE196R/6LAN	196R, 196RV, 196T, 194T	
<ul style="list-style-type: none"> <li>Cerradero fijo de acero inoxidable para solo picaporte</li> </ul>			
	CE196R/6LR		
<ul style="list-style-type: none"> <li>Cerradero regulable de acero inoxidable con levas</li> </ul>			

## PUERTAS BATIENTES

## ACCESORIOS

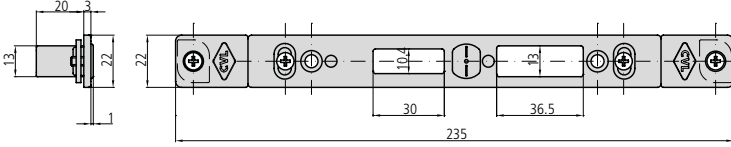
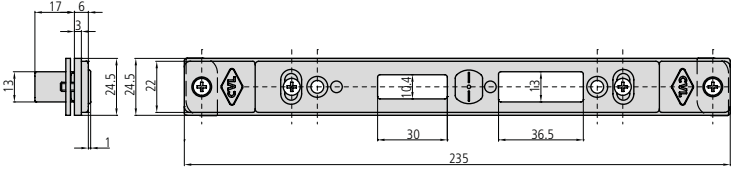
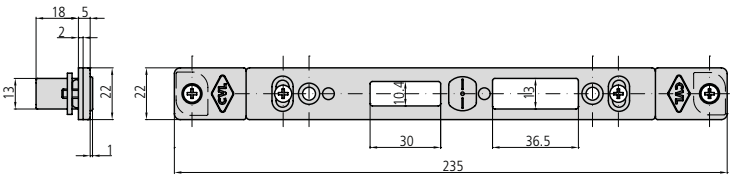
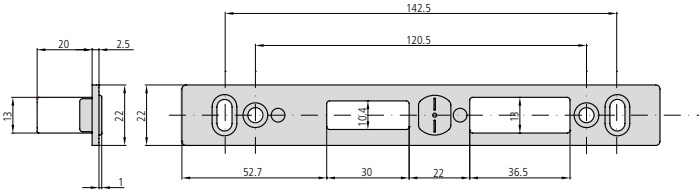
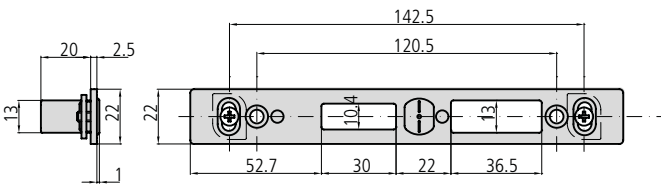
## CERRADEROS

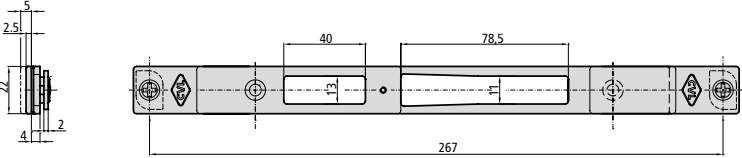
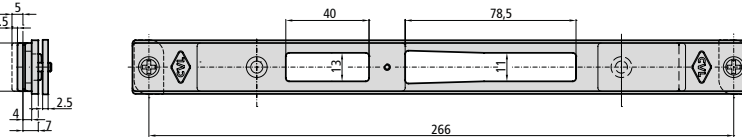
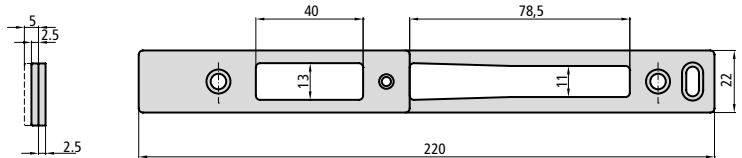
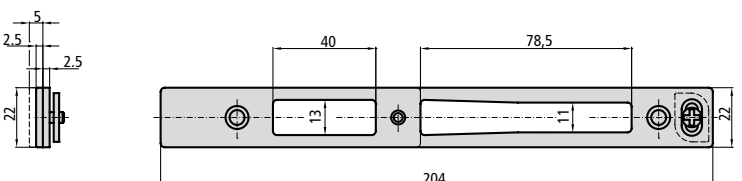

DESCRIPCIÓN	REF.	APLICABLE A CERRADURAS	UDS  	PRECIO COMPLETA S/CILINDRO
				
• Cerradero regulable metálico negro	CE2A2S/1NR			
				
• Cerradero regulable metálico negro con suplemento	CE2A2S/1NRS			
				
• Cerradero regulable metálico negro con suplemento de 22mm*2mm	CE2A2S/1N22			2A2 alto / bajo
				
• Cerradero fijo de acero inoxidable	CE2A2S/6L			
				
• Cerradero regulable de acero inoxidable con levas	CE2A2S/6LR			

DESCRIPCIÓN	REF.	APLICABLE A CERRADURAS	UDS  
 <ul style="list-style-type: none"> <li>Cerradero regulable metálico negro, incluye 1 suplemento de 2,5 mm y otro de 5 mm</li> </ul>	KCE1K5/1NR	1K2, 1K5, central 2K2, central 2K5	-----
 <ul style="list-style-type: none"> <li>Cerradero regulable metálico negro con suplemento, incluye 1 suplemento de 2,5 mm y otro de 5 mm</li> </ul>	KCE1K5/1NRS	1K2, 1K5, central 2K2, central 2K5	-----
 <ul style="list-style-type: none"> <li>Cerradero fijo de acero inoxidable de 22 mm, incluye 1 suplemento de 2,5 mm y otro de 5 mm</li> </ul>	KCE1K5/6L	1K2, 1K5, central 2K2, central 2K5	-----
 <ul style="list-style-type: none"> <li>Cerradero regulable de acero inoxidable, incluye 1 suplemento de 2,5 mm y otro de 5 mm con levas</li> </ul>	KCE1K5/6LR	1K2, 1K5, central 2K2, central 2K5	-----



## PUERTAS BATIENTES

## ACCESORIOS

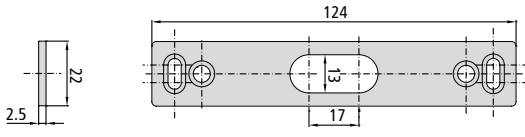
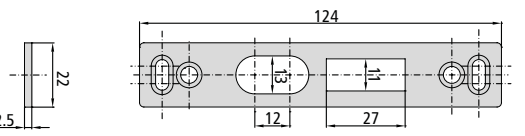
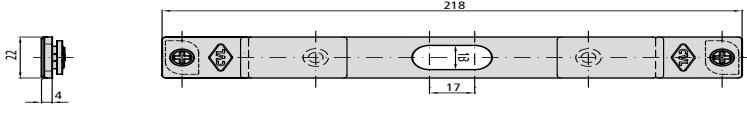
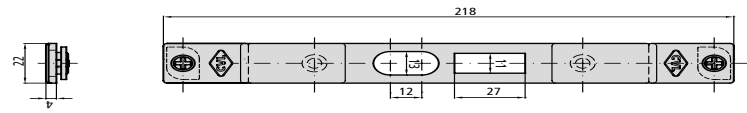
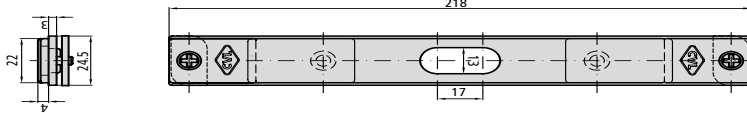
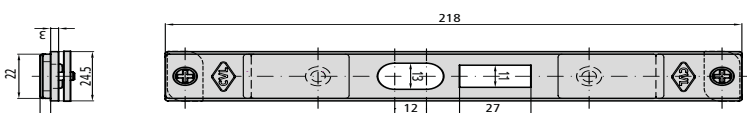
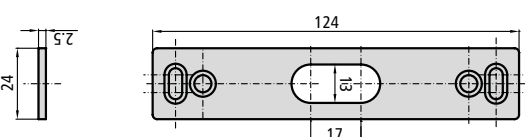
## CERRADEROS

DESCRIPCIÓN	REF.	APLICABLE A CERRADURAS	UDS  
 <p>• Cerradero fijo de acero inoxidable</p>	CE202S/6L	alto / bajo 2I2	-----
 <p>• Cerradero fijo de acero inoxidable</p>	CE202GB/6L	alto / bajo 2I2GB, 2E2GB	-----
 <p>• Cerradero regulable metálico negro</p>	CE202S/1NR	alto / bajo 2I2	-----
 <p>• Cerradero regulable metálico negro</p>	CE202GB/1NR	alto / bajo 2I2GB, 2E2GB	-----
 <p>• Cerradero regulable metálico negro con suplemento</p>	CE202S/1NRS	alto / bajo 2I2	-----
 <p>• Cerradero regulable metálico negro con suplemento</p>	CE202GB/1NRS	alto / bajo 2I2GB, 2E2GB	-----
 <p>• Cerradero fijo de acero inoxidable de 24 mm</p>	CE202S/6LAN	alto / bajo 2I2	-----

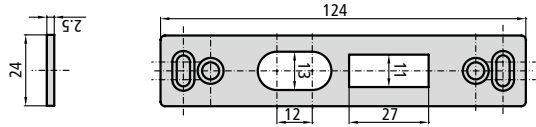
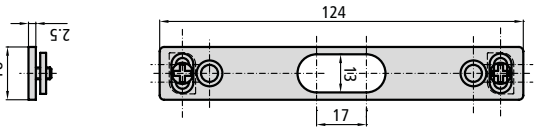
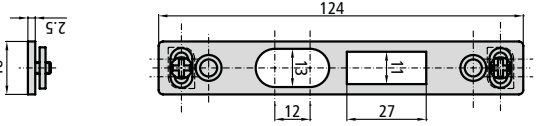
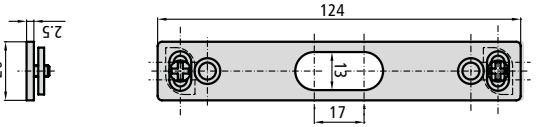
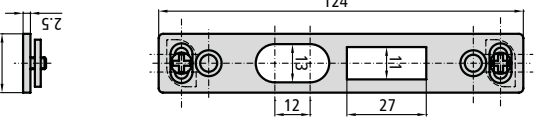
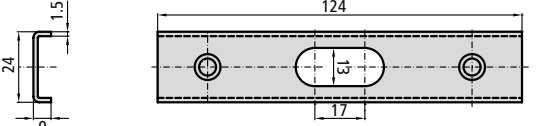

**PUERTAS BATIENTES**
**ACCESORIOS**
**CERRADEROS**

DESCRIPCIÓN	REF.	APLICABLE A CERRADURAS	UDS  
	• Cerradero fijo de acero inoxidable CE202GB/6LAN	alto / bajo 2I2GB, 2E2GB	-----
	• Cerradero regulable de acero inoxidable con levas CE202S/6LR18	alto / bajo 2I2	-----
	• Cerradero regulable de acero inoxidable con levas CE202GB6LR18	alto / bajo 2I2GB, 2E2GB	-----
	• Cerradero regulable de acero inoxidable con levas CE202S/6LR20	alto / bajo 2I2	-----
	• Cerradero regulable de acero inoxidable con levas CE202GB6LR20	alto / bajo 2I2GB, 2E2GB	-----
	• Cerradero regulable de acero inoxidable con levas CE202S/6U	alto / bajo 2I2	-----

## PUERTAS BATIENTES

## ACCESORIOS

## CERRADEROS ELÉCTRICOS

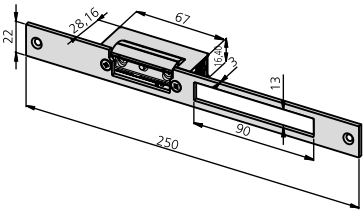
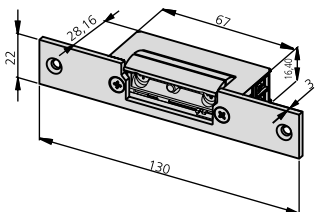
DESCRIPCIÓN	REF.	APLICABLE A CERRADURAS	UDS  
<ul style="list-style-type: none"> <li>• Cerradero eléctrico regulable reversible con funcionamiento automático y con desbloqueo</li> <li>• Frente plano inox</li> <li>• 12V/Corriente alterna</li> </ul> 	CEC41/6AD	184, 196, 197, 296, 396, 496, 596, 192, F192, 194, 294N, 494N, 183, 612, 612E, 615E, 615	
<ul style="list-style-type: none"> <li>• Cerradero eléctrico regulable reversible con funcionamiento automático y con desbloqueo</li> <li>• Sólo picaporte y frente plano inox</li> <li>• 12V/Corriente alterna</li> </ul> 	CEC41T/6AD	196T, 194T, 183T	

\* Otros tipos de cerradero eléctrico consultar.

**PUERTAS BATIENTES**
**ACCESORIOS**
**ESCUDOS Y MANILLAS DE ACERO INOXIDABLE**

DESCRIPCIÓN	REF.	ACABADO	CANTO	UDS
<ul style="list-style-type: none"> <li>Entre centros 85 mm</li> <li>Atado rosca chapa</li> </ul>	JM6006/85/1B JM6006/85/1N	Lacado blanco Lacado negro	Red. Red.	2 2
<ul style="list-style-type: none"> <li>Entre centros 85 mm</li> <li>Atado pasante</li> </ul>	JM6006P/85/1B JM6006P/85/1N	Lacado blanco Lacado negro	Red. Red.	2 2
<ul style="list-style-type: none"> <li>Juego escudo con manilla y bocallave cilindro para aluminio</li> <li>Entre ejes 85 mm</li> <li>No incluye cilindro</li> </ul>	JM6006/85/6R	Al	Red.	2
<ul style="list-style-type: none"> <li>Juego roseta para aluminio más juego escudo</li> </ul>	JMB6000/6R	Al	Red.	2

## PUERTAS BATIENTES

## ACCESORIOS



## ESCUDOS Y MANILLAS DE ACERO INOXIDABLE

DESCRIPCIÓN	REF.	ACABADO	CANTO	UDS 	
<ul style="list-style-type: none"> <li>Juego escudo para cilindro</li> </ul> 	JES6000/6R	Al	Red.	2	
<ul style="list-style-type: none"> <li>Juego placa con tirador y bocallave de cilindro</li> <li>No incluye cilindro</li> </ul> 	JT6006/85/6R	Al	Red.	2	



ACCESORIOS

ESCUDOS

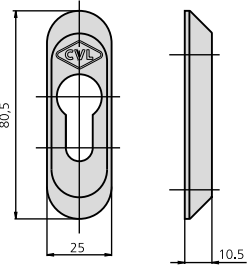
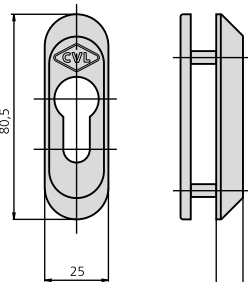
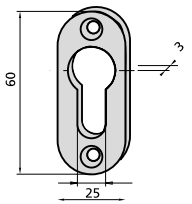
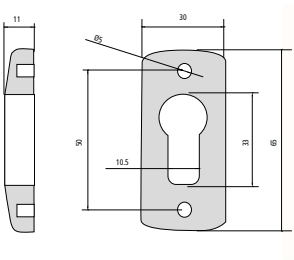
DESCRIPCIÓN	REF.	ACABADO	CANTO	UDS 	PRECIO 
					COMPLETA S/CILINDRO
 <p>80.5 25 10.5</p>					
<ul style="list-style-type: none"> <li>Escudo de seguridad no pasante, 1 escudo de zamak y 2 tornillos</li> </ul>	BT194/1N	Negro			
 <p>80.5 25 10.5</p>					
<ul style="list-style-type: none"> <li>Escudo de seguridad pasante con contraescudo, 1 escudo de zamak, capucha de nylon para contraescudo y dos tornillos pasantes</li> <li>1 escudo de zamak</li> </ul>	BT1296/1N	Negro			
 <p>60 25</p>					
<ul style="list-style-type: none"> <li>Escudo de nylon</li> </ul>	ES1984	Negro			
 <p>11 30 10.5 18 16 28 10.5</p>					
	ES184/1N	Lacado negro			
	ES184/1B	Lacado blanco			

## PUERTAS BATIENTES

## ACCESORIOS

## OTROS

DESCRIPCIÓN	REF.	APLICABLE A SERIES	UDS  
 <ul style="list-style-type: none"> <li>Terminal de nylon</li> </ul>	EMB196	184, 192, 196, 197, 194, 1E5, 1E2, 1K5	10
 <ul style="list-style-type: none"> <li>Conjunto vaivén</li> </ul>	CV1E5	1E5, 2E5, 1E2, 2E2, 294N, 2E2GB, 4E25	1
 <ul style="list-style-type: none"> <li>Plástico reductor vaivén</li> </ul>	KTVCE15 KTVCE13		5 5
 <ul style="list-style-type: none"> <li>Tapa resbalón para la serie SOFT</li> </ul>	TAP1E5	1E5, 2E5, 1E2, 2E2, 2E2GB, 4E25	1
 <ul style="list-style-type: none"> <li>Poliamida extruída para perfiles de Cámara Europea</li> </ul>	POLCE-CVL	3I2	100 m
 <ul style="list-style-type: none"> <li>Punto de cierre final para cámara europea y con un cierre adicional</li> </ul>	PCF3I21CE	3I2	
 <ul style="list-style-type: none"> <li>Punto de cierre intermedio para cámara europea</li> </ul>	PCI3I2CE	3I2	
 <ul style="list-style-type: none"> <li>Cerradero regulable para cámara europea y punto de cierre intermedio</li> </ul>	CE3I2PCICE	3I2	
 <ul style="list-style-type: none"> <li>Contacto con muelles que se empotran en el marco de la puerta sin dejar cables visibles</li> </ul>	CONNECT01	1K5, 1K2, 2K5, 2K2, 2A2	

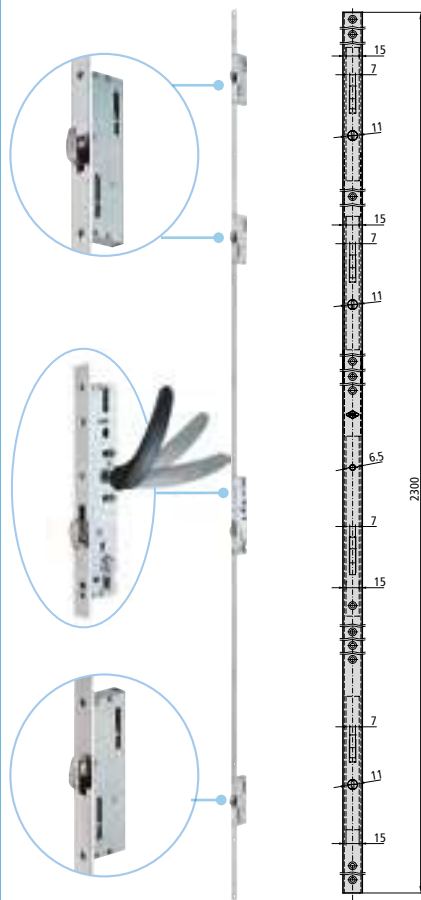
**PUERTAS CORREDERAS**
**MULTIPUNTO PALANCA GANCHO ENTRE EJES 85 mm.**
**SERIE 4I54K**

**CARACTERÍSTICAS**

- Cerraduras para puertas correderas
- Cerradura de 4 puntos con facilidad de cierre mediante manilla hacia arriba (90°) y bloqueo mediante llave
- Cierre mediante 4 ganchos
- Sistema anti falsa maniobra (bloqueo de manilla en modo de puerta abierta)
- Posibilidad de atado de manilla a 21,5 mm ↑↓ pasante o directo a la cerradura
- Frente inox U de 2300 x 16 x 6 y 2300 x 22 x 6
- Caja cerrada de 15 mm
- Cuadradillo de 7 mm
- Tornillo de fijación de cilindro

**ACCESORIOS OPCIONALES**

- Gama completa de cilindros (ver página 128 - 148)
- Kit acople y punto de cierre adicional (ver página 10)
- Estudio personalizado de cerraderos

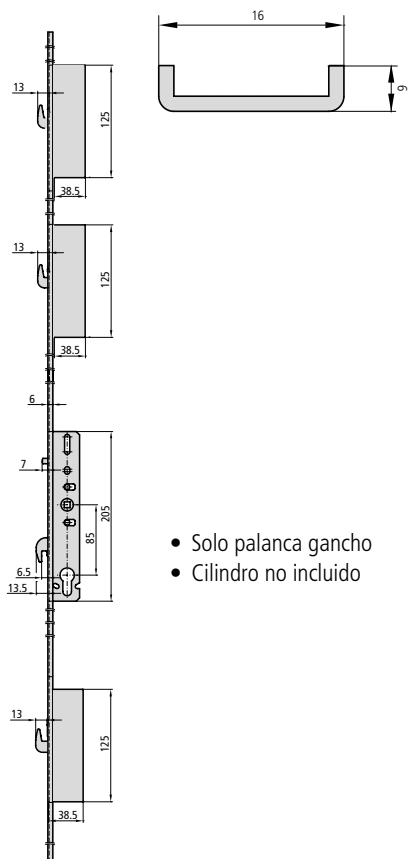
DESCRIPCIÓN	REF.	MEDIDAS		LEVA	ACABADOS		UDS	
		B	A		FRENTE	CILINDRO		



4I54K256U16	18	33	15	Al		1	
· cuadradillo de 7mm							
4I54K8256U16	18	33	15	Al		1	
· cuadradillo de 8mm							

- Solo palanca gancho
- Cilindro no incluido

## PUERTAS CORREDERAS

## MULTIPUNTO PALANCA GANCHO ENTRE EJES 85 mm.

## SERIE 2I5K

## CARACTERÍSTICAS

- Cerraduras para puertas correderas
- Cerradura de 3 puntos con facilidad de cierre mediante manilla hacia arriba (90°) y bloqueo mediante llave
- Cierre mediante 3 ganchos
- Sistema anti falsa maniobra (bloqueo de manilla en modo de puerta abierta)
- Posibilidad de atado de manilla a 21,5 mm ↑ pasante o directo a la cerradura
- Frente inox U de 1850 x 16 x 6 y 1850 x 22 x 6
- Caja cerrada de 15 mm
- Tornillo de fijación de cilindro

## ACCESORIOS OPCIONALES

- Gama completa de cilindros (ver página 128 - 148)
- Estudio personalizado de cerraderos

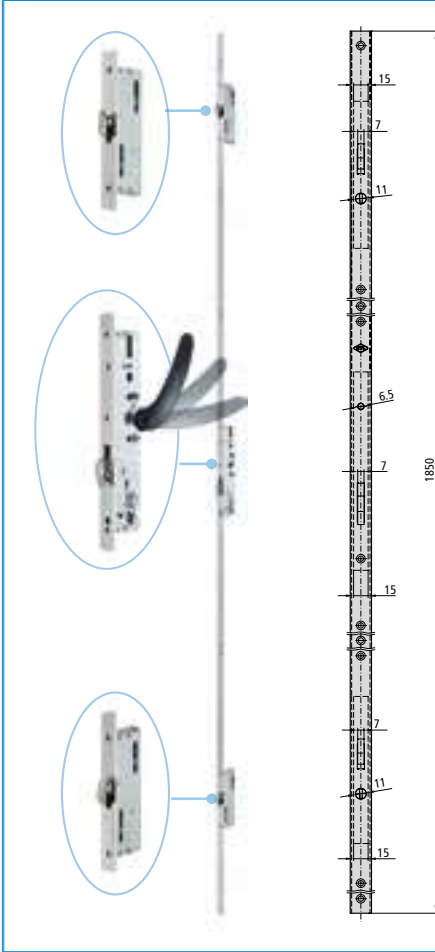

## DESCRIPCIÓN

## REF.

## MEDIDAS

## LEVA

## ACABADOS

## UDS

B A

FRENTE CILINDRO

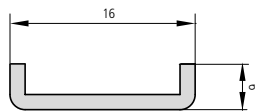
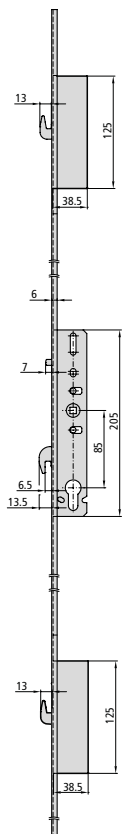

2I5K25/6U16 18 33 15 Al 1

· cuadradillo de 7mm

2I5K825/6U16 18 33 15 Al 1

· cuadradillo de 8mm

- Solo palanca gancho
- Cilindro no incluido

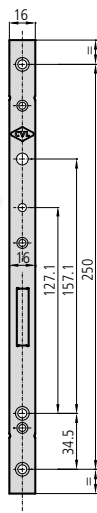
**PUERTAS CORREDERAS**
**PALANCA GANCHO ENTRE EJES 85 mm.**
**SERIE 115K**

**CARACTERÍSTICAS**

- Cerraduras para puertas correderas
- Cerradura de 1 punto con facilidad de cierre mediante manilla hacia arriba (90°) y bloqueo mediante llave
- Cierre mediante gancho
- Sistema anti falsa maniobra (bloqueo de manilla en modo de puerta abierta)
- Posibilidad de atado de manilla a 21,5 mm ↑↓ pasante o directo a la cerradura
- Frente inox U
- Caja cerrada de 15 mm
- Tornillo de fijación de cilindro

**ACCESSOIRES EN OPTION**

- Gama completa de cilindros (ver página 128 - 148)
- Estudio personalizado de cerraderos

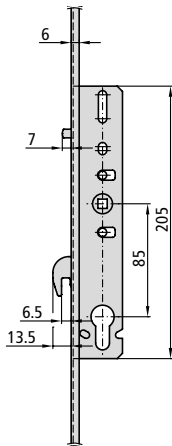
DESCRIPCIÓN	REF.	MEDIDAS		LEVA	ACABADOS		UDS
		B	A		FRENTE	CILINDRO	



115K25/6U16	18	33	15	Al		1
-------------	----	----	----	----	--	---

## PUERTAS CORREDERAS

## MULTIPUNTO PALANCA GANCHO

## SERIE 297KN

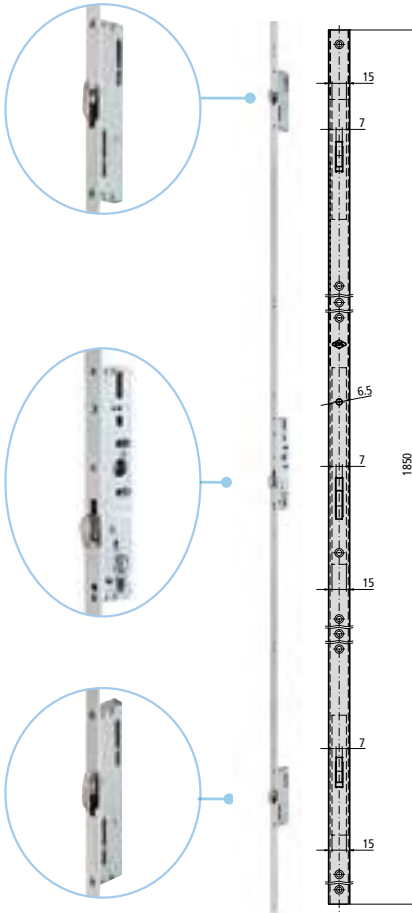

## CARACTERÍSTICAS

- Para puertas correderas
- Frente inox U de 1850x16x6 mm
- Caja de 15 mm
- Cuadrado de 8 mm
- Anti falsa maniobra
- Tornillo de fijación de cilindro

## ACCESORIOS OPCIONALES

- Gama completa de cilindros (ver página 128 - 148)
- Estudio personalizado de cerraderos

## DESCRIPCIÓN

REF.

MEDIDAS  
B A

LEVA

ACABADOS  
FRETE CILINDRO

UDS

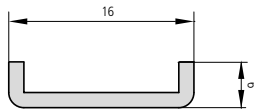
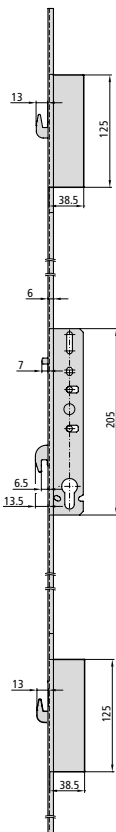

297KN25/6U16 18

18

33

15

Al

1

- Solo palanca gancho
- Cilindro no incluido

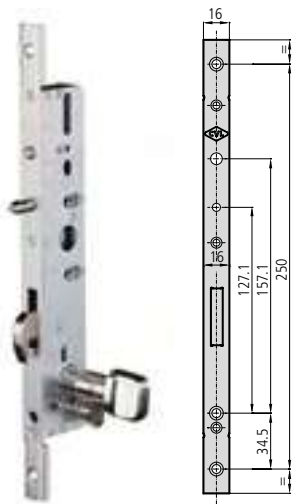
**PUERTAS CORREDERAS**
**PALANCA GANCHO Y ANTIFALSA MANIOBRA**
**SERIE 197KBN**

**CARACTERÍSTICAS**

- Para puertas correderas
- Frente inox U de 16x6 mm
- Caja de 15 mm
- Anti falsa maniobra
- Tornillo de fijación de cilindro

**ACCESORIOS OPCIONALES**

- Gama completa de cilindros (ver página 128 - 148)

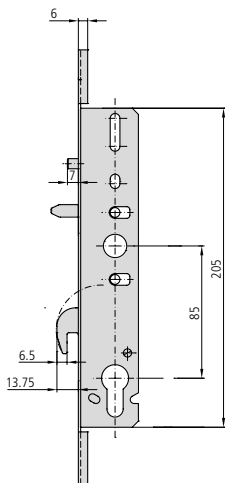
DESCRIPCIÓN	REF.	MEDIDAS		LEVA	ACABADOS		UDS	
		B	A		FRENTE	CILINDRO		
	197KBN25/6U16	18	33	15	Al			1



## PUERTAS CORREDERAS

## PALANCA GANCHO CON CILINDRO EUROPERFIL

## SERIE 198K

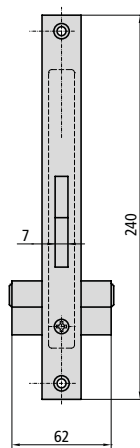

## CARACTERÍSTICAS

- Frente inox de 16 mm, 17 mm ó 22 mm
- Caja de 15 mm
- 2 escudos de nylon ref. ES1984
- Tornillo de fijación de cilindro

## ACCESORIOS OPCIONALES

- Gama completa de cilindros (ver página 128 - 148)
- Estudio personalizado de cerraderos

DESCRIPCIÓN	REF.	MEDIDAS		LEVA	ACABADOS		UDS		
		B	A		FRENTE	CILINDRO			
<ul style="list-style-type: none"> <li>• Cerradura para puerta corredera</li> <li>• Sólo palanca gancho</li> <li>• Cilindro de leva larga 5982/2525/4</li> </ul>									
	P198K25/6	22	37	15	Al	CN	1	20	
	P198K30/6	27	42	15	Al	CN	1	20	
	P198K35/6	32	47	15	Al	CN	1	20	
<ul style="list-style-type: none"> <li>• Cerradura para puerta corredera</li> <li>• Sólo palanca gancho con pin de seguridad</li> <li>• Cilindro de leva larga 5982/2525/4</li> </ul>									
	P198KB25/6	22	37	15	Al	CN	1	20	
	P198KB30/6	27	42	15	Al	CN	1	20	
	P198KB35/6	32	47	15	Al	CN	1	20	
<ul style="list-style-type: none"> <li>• Cerradura para puerta corredera</li> <li>• Sólo palanca gancho</li> <li>• Pin deslizantes</li> <li>• Cilindro de leva corta 5990/2525/4</li> </ul>									
	P198KD20/6	17	30	13,25	Al	CN	1	20	
	P198KD20/6	17	30	13,25	Al	CN	1	20	

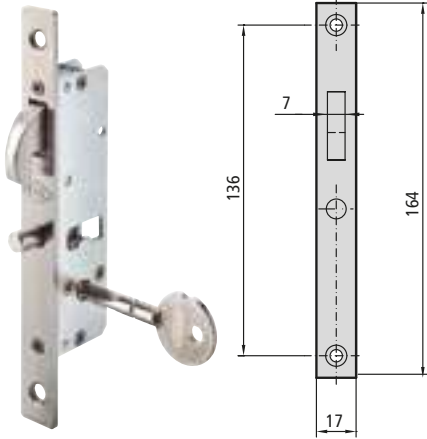

**PUERTAS CORREDERAS**
**PALANCA GANCHO CON CILINDRO TETRA**
**SERIE 1T8**
**CARACTERÍSTICAS**

- Frente inox de 17 mm ó 22 mm
- Caja de 15 mm
- 2 escudos de nylon blancos y 2 escudos de nylon negros

**DESCRIPCIÓN**
**REF.**
**MEDIDAS  
B A**
**LEVA**
**ACABADOS  
FRETE ESCUDOS**

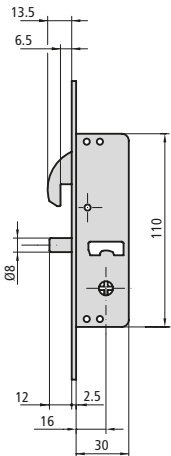
**UDS**

- Cerradura para puerta corredera
- Sólo palanca gancho
- Pin deslizante
- Cilindro tetra con llave en cruz

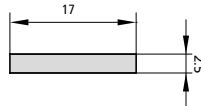

1T8KD20/6L17B

16

30

Al

Blanco

1

20

1T8KD20/6L17N

16

30

Al

Negro

1

20

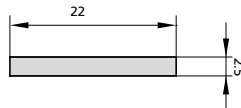

1T8KD20/6LB

16

30

Al

Blanco

1

20

1T8KD20/6LN

16

30

Al

Negro

1

20



## CERRADURAS DE EMBUTIR PARA CARPINTERÍA METÁLICA

Palanca deslizante entre ejes 85 cilindro europerfil leva corta	66
• Serie 1984	66
Palanca deslizante entre ejes 85 cilindro europerfil leva larga	67
• Serie 1995	67
Palanca gancho entre ejes 85 cilindro europerfil	69
• Serie 190	69
• Serie 1990	70
• Serie 1994	71
Multipunto palanca gancho entre ejes 85	73
• Serie 2994	73
• Serie 3994	75
Palanca deslizante entre ejes 92 cilindro europerfil	77
• Serie 1992	77
Palanca deslizante entre ejes 70 cilindro europerfil	78
• Serie 1983	78
Palanca deslizante entre ejes 85 cilindro ovalado monoblock	80
• Serie 1963	80
• Serie 1975	82
Palanca deslizante entre ejes 74 cilindro ovalado de vástagos	83
• Serie 1964	83
Cerradura para puertas de zócalo con cilindro ovalado de vástagos	85
• Serie 1981	85
Cerradura para puertas de zócalo con cilindro europerfil	86
• Serie 1991	86
Cerradura de sólo gancho con cilindro ovalado de vástagos	87
• Serie 1968	87
Cerradura de sólo gancho con cilindro europerfil	88
• Serie 1982	88
Cerradura de sólo picaporte para puertas metálicas	89
• Serie 1979	89
Cerradura para puertas y persianas metálicas enrollables	90
• Serie 11A	90
Cerradura para puertas metálicas basculantes	91
• Serie 11B	91
Accesorios	92
• Cerraderos para cerraduras metálicas	92
• Cerraderos eléctricos	95
• Escudos	96
• Escudos de seguridad	96

**PALANCA DESLIZANTE ENTRE EJES 85 CILINDRO EUROPERFIL LEVA CORTA**

**SERIE 1984**

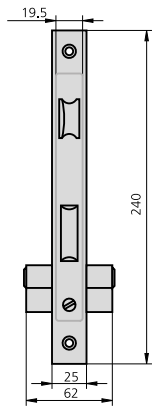

**CARACTERÍSTICAS**

- Frente hierro niquelado ó acero inoxidable
- Caja bicromatada
- Palanca deslizante
- Picaporte reversible
- Cuadradillo de 8 mm
- Cilindro europerfil
- 2 escudos de nylon ref. ES1984
- Tornillo de fijación de cilindro

**ACCESORIOS OPCIONALES**

- Cerraderos según cerradura (ver abajo)
- Gama completa de cilindros (ver página 128 - 148)

DESCRIPCIÓN	REF.	MEDIDAS		LEVA	ACABADOS		UDS	
		B	A		FRENTE	CILINDRO		

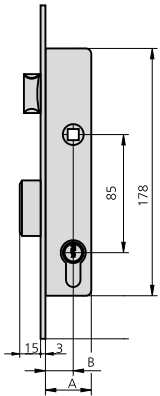

- Picaporte y palanca
- Cilindro 5990/2525

**Opciones de cerradero**

- CE1984/0 o CE1984/6

**Opción cerraderos eléctricos**

- CEC45/6A
- CEC45/6AD

1984/20/0	20	33	13,25	HN	CN	1	20
1984/20/5	20	33	13,25	HN	CL	1	20
1984/20/6	20	33	13,25	Al	CN	1	20
1984/25/0	25	38	13,25	HN	CN	1	20
1984/25/5	25	38	13,25	HN	CL	1	20
1984/25/6	25	38	13,25	Al	CN	1	20
1984/30/0	30	43	13,25	HN	CN	1	20
1984/30/5	30	43	13,25	HN	CL	1	20
1984/30/6	30	43	13,25	Al	CN	1	20

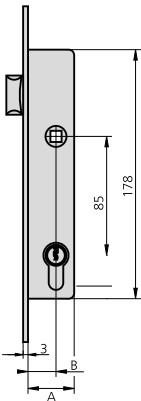

- Sólo picaporte
- Cilindro 5982T40/4

**Opción cerraderos eléctricos**

- CEC45/6A o CEC45/6AD

1984T20/6	20	33	15	Al	CN	1	20
1984T25/6	25	38	15	Al	CN	1	20
1984T30/6	30	43	15	Al	CN	1	20

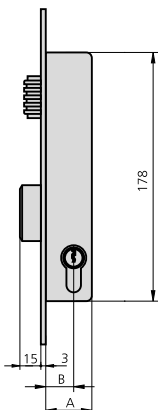

- Rodillo vaivén regulable y palanca
- Cilindro 5990/2525

**Opciones de cerradero**

- CE1984/6

1984V20/6	20	33	13,25	Al	CN	1	20
1984V25/6	25	38	13,25	Al	CN	1	20
1984V30/6	30	43	13,25	Al	CN	1	20

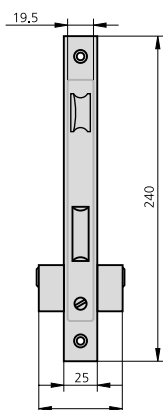

**CARACTERÍSTICAS**

- Frente hierro niquelado ó acero inoxidable
- Caja bicromatada
- Palanca deslizante
- Picaporte reversible
- Cuadradillo de 8 mm
- Cilindro europerfil
- 2 escudos de nylon ref. ES1984
- Tornillo de fijación de cilindro

**ACCESORIOS OPCIONALES**

- Cerraderos según cerradura (ver abajo)
- Amplia gama de cilindros (ver página 128 - 148)

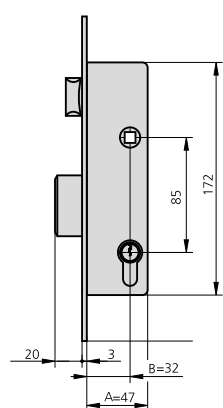
DESCRIPCIÓN	REF.	MEDIDAS		LEVA	ACABADOS		UDS	
		B	A		FRENTE	CILINDRO		



- Picaporte y palanca
- Cilindro 5982/2525

1995/32/0	32	47	15	HN	CN	1	20
1995/32/5	32	47	15	HN	CL	1	20
1995/32/6	32	47	15	Al	CN	1	20

**Opciones de cerradero**

- CE1984/0 o CE1984/6

**Opciones cerraderos eléctricos**

- CELC45/6A o CELC45/6AD

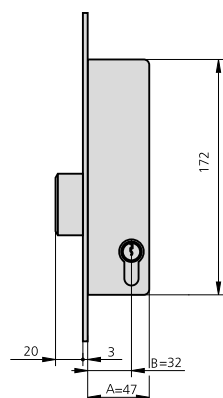

- Sólo palanca
- Cilindro 5982/2525/4

1995A32/6	32	47	15	Al	CN	1	20
-----------	----	----	----	----	----	---	----

**Opciones de cerradero**

- CE2994S/6

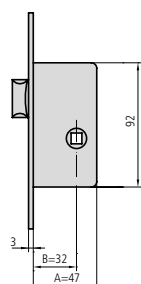



- Sólo picaporte
- Sin cilindro

1995R32/0	32	47		HN		1	30
-----------	----	----	--	----	--	---	----

**PALANCA DESLIZANTE ENTRE EJES 85 CILINDRO EUROPERFIL LEVA LARGA**

**SERIE 1995**

DESCRIPCIÓN	REF.	MEDIDAS		LEVA	ACABADOS		UDS	
		B	A		FRENTE	CILINDRO		

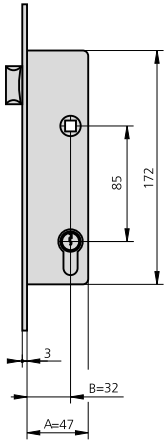

- Sólo picaporte
- Cilindro 5982T40/4

1995T32/6	32	47	15	Al	CN	1	20
-----------	----	----	----	----	----	---	----

**Opciones cerraderos eléctricos**

- CELC45T/6A o CELC45T/6AD

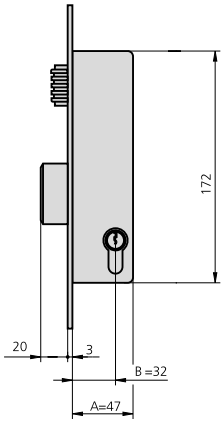

- Rodillo vaivén regulable y palanca
- Cilindro 5982/2525/4

1995V32/6	32	47	15	Al	CN	1	20
-----------	----	----	----	----	----	---	----

**Opciones de cerradero**

- CE1984/6

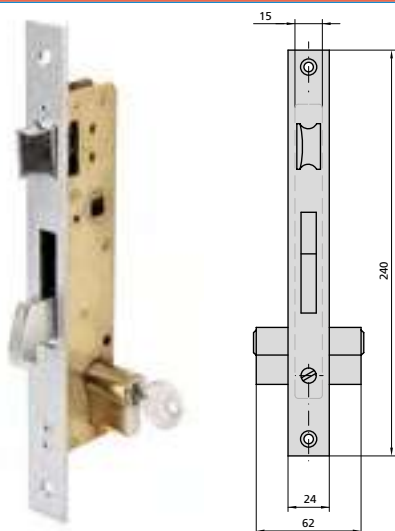

**CARACTERÍSTICAS**

- Frente de 24 mm
- Picaporte reversible
- Caja bicromatada de 15 mm
- Cuadradillo de 8 mm
- Cilindro europerfil
- 2 escudos de nylon ref. ES1984
- Tornillo de fijación de cilindro

**ACCESORIOS OPCIONALES**

- Gama completa de cilindros (ver página 128 - 148)

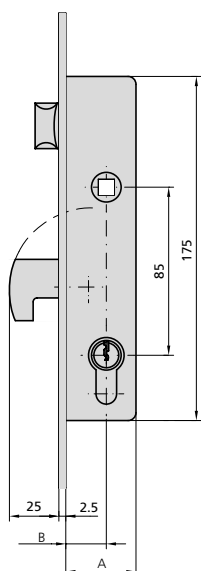
DESCRIPCIÓN	REF.	MEDIDAS		LEVA	ACABADOS		UDS	
		B	A		FRENTE	CILINDRO		



- Picaporte y palanca
- Cilindro 5990/2525

**Opciones de cerradero**

- CE190/0 o CE190/6

**Opciones cerraderos eléctricos**

- CELC45/6A o CELC45/6AD

190/23/0	20	33	13,25	HN	CN	1	20
190/23/5	20	33	13,25	HN	CL	1	20
190/23/6	20	33	13,25	Al	CN	1	20
190/28/0	25	38	13,25	HN	CN	1	20
190/28/5	25	38	13,25	HN	CL	1	20
190/28/6	25	38	13,25	Al	CN	1	20
190/33/0	30	43	13,25	HN	CN	1	20
190/33/5	30	43	13,25	HN	CL	1	20
190/33/6	30	43	13,25	Al	CN	1	20

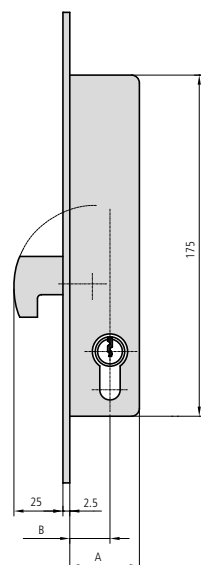

- Solo palanca
- Cilindro 5990/2525

**Opciones de cerradero**

- CE190/0 o CE190/6

190A23/0	20	33	13,25	HN	CN	1	20
190A23/5	20	33	13,25	HN	CL	1	20
190A23/6	20	33	13,25	Al	CN	1	20
190A28/0	25	38	13,25	HN	CN	1	20
190A28/5	25	38	13,25	HN	CL	1	20
190A28/6	25	38	13,25	Al	CN	1	20
190A33/0	30	43	13,25	HN	CN	1	20
190A33/5	30	43	13,25	HN	CL	1	20
190A33/6	30	43	13,25	Al	CN	1	20

**PALANCA GANCHO ENTRE EJES 85 CILINDRO EUROPERFIL**

**SERIE 1990**

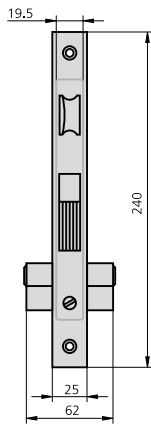

**CARACTERÍSTICAS**

- Frente hierro niquelado o acero inoxidable
- Caja bicromatada
- Palanca basculante de gancho
- Picaporte reversible
- Cuadradillo de 8 mm
- Cilindro europerfil
- 2 escudos de nylon ref. ES1984
- Tornillo de fijación de cilindro

**ACCESORIOS OPCIONALES**

- Gama completa de cilindros (ver página 128 - 148)

DESCRIPCIÓN	REF.	MEDIDAS		LEVA	ACABADOS		UDS	
		B	A		FRENTE	CILINDRO		

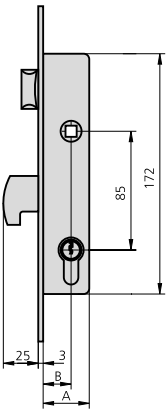

- Picaporte y palanca
- Cilindro 5990/2525 o 5982/2525
- Cerradero CE1990/0
- Opciones cerraderos eléctricos**
- CELC45/6A o CELC45/6AD

1990/20/0	20	33	13,25	HN	CN	1	20
1990/20/5	20	33	13,25	HN	CL	1	20
1990/20/6	20	33	13,25	AI	CN	1	20
1990/25/0	25	38	13,25	HN	CN	1	20
1990/25/5	25	38	13,25	HN	CL	1	20
1990/25/6	25	38	13,25	AI	CN	1	20
1990/32/0	32	47	15	HN	CN	1	20
1990/32/5	32	47	15	HN	CL	1	20
1990/32/6	32	47	15	AI	CN	1	20

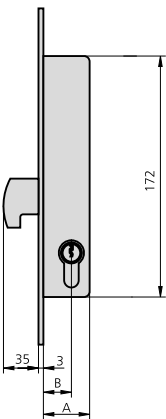

- Sólo palanca
- Cilindro 5990/2525 o 5982/2525
- Cerradero CE1990/0

1990A20/0	20	33	13,25	HN	CN	1	20
1990A20/5	20	33	13,25	HN	CL	1	20
1990A20/6	20	33	13,25	AI	CN	1	20
1990A25/0	25	38	13,25	HN	CN	1	20
1990A25/5	25	38	13,25	HN	CL	1	20
1990A25/6	25	38	13,25	AI	CN	1	20
1990A32/0	32	47	15	HN	CN	1	20
1990A32/5	32	47	15	HN	CL	1	20
1990A32/6	32	47	15	AI	CN	1	20

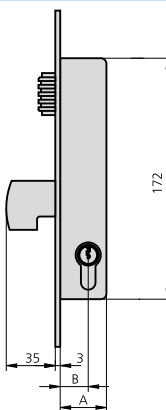

- Rodillo vaivén regulable y palanca
- Cilindro 5990/2525 o 5982/2525
- Cerradero CE1990/0

1990V20/0	20	33	13,25	HN	CN	1	20
1990V20/5	20	33	13,25	HN	CL	1	20
1990V20/6	20	33	13,25	AI	CN	1	20
1990V25/0	25	38	13,25	HN	CN	1	20
1990V25/5	25	38	13,25	HN	CL	1	20
1990V25/6	25	38	13,25	AI	CN	1	20
1990V32/0	32	47	15	HN	CN	1	20
1990V32/5	32	47	15	HN	CL	1	20
1990V32/6	32	47	15	AI	CN	1	20



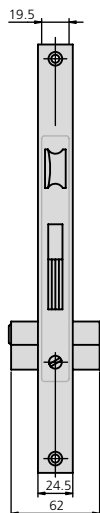

**CARACTERÍSTICAS**

- Frente de acero inoxidable
- Caja bicromatada
- Palanca basculante de gancho
- Picaporte reversible
- Cuadradillo de 8 mm
- Cilindro europerfil
- Tornillo de fijación de cilindro
- Cerradero según cerradura

**ACCESORIOS OPCIONALES**

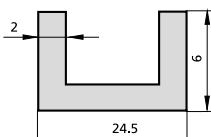
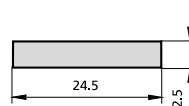
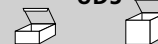
- Gama completa de cilindros (ver página 128 - 148)



**FRENTE U**

**FRENTE LISO**
**DESCRIPCIÓN**
**REF.**
**MEDIDAS**  
**B A**
**LEVA**
**ACABADOS**  
**FRENTE CILINDRO**
**UDS**

- Picaporte y palanca
- Cilindro 5982/2525/4
- Cerradero CE1994/6

**FRENTE U**
**Opciones cerraderos eléctricos**

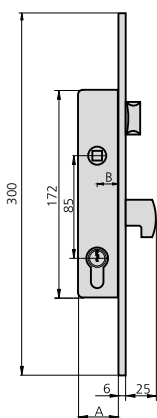
- CELC45/6A o CELC45/6AD

1994/25/6U	18	33	15	Al	CN	1	10
1994/30/6U	23	38	15	Al	CN	1	10
1994/35/6U	28	43	15	Al	CN	1	10





- Picaporte y palanca
- Cilindro 5982/2525/4
- Cerradero CE1994/6

**FRENTE LISO**
**Opciones cerraderos eléctricos**

- CELC45/6A o CELC45/6AD

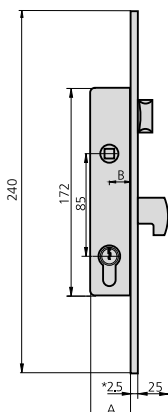
1994/25/6L	22	37	15	Al	CN	1	20
1994/30/6L	27	42	15	Al	CN	1	20
1994/35/6L	32	47	15	Al	CN	1	20

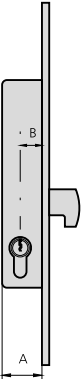

DESCRIPCIÓN	REF.	MEDIDAS		LEVA	ACABADOS		UDS	
		B	A		FRENTE	CILINDRO		
 <ul style="list-style-type: none"> <li>• Sólo palanca</li> <li>• Cilindro 5982/2525/4</li> <li>• Cerradero CE1994/6</li> </ul>	1994A25/6U	18	33	15	Al	CN	1	10
	1994A30/6U	23	38	15	Al	CN	1	10
	1994A35/6U	28	43	15	Al	CN	1	10
<ul style="list-style-type: none"> <li>• Sólo palanca</li> <li>• Cilindro 5982/2525/4</li> <li>• Cerradero CE1994/6</li> </ul>	1994A25/6L	22	37	15	Al	CN	1	20
	1994A30/6L	27	42	15	Al	CN	1	20
	1994A35/6L	32	47	15	Al	CN	1	20

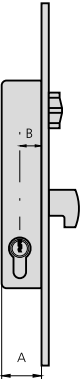
 <ul style="list-style-type: none"> <li>• Rodillo vaivén regulable y palanca</li> <li>• Cilindro 5982/2525/4</li> <li>• Cerradero CE1994/6</li> </ul>	1994V25/6U	18	33	15	Al	CN	1	10
	1994V30/6U	23	38	15	Al	CN	1	10
	1994V35/6U	28	43	15	Al	CN	1	10
<ul style="list-style-type: none"> <li>• Rodillo vaivén regulable y palanca</li> <li>• Cilindro 5982/2525/4</li> <li>• Cerradero CE1994/6</li> </ul>	1994V25/6L	22	37	15	Al	CN	1	20
	1994V30/6L	27	42	15	Al	CN	1	20
	1994V35/6L	32	47	15	Al	CN	1	20

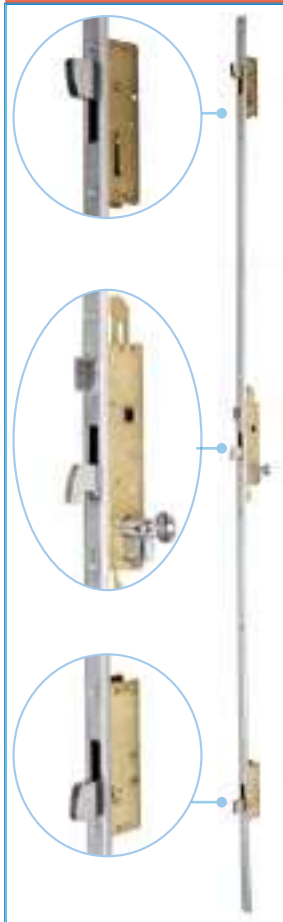
**CARACTERÍSTICAS**

- Frente de acero inoxidable
- Caja bicromatada
- Palanca basculante de gancho
- Picaporte reversible
- Cuadradillo de 8 mm
- Cilindro euoperfil de seguridad
- Tornillo de fijación de cilindro
- Cerradero según cerradura
- Escudo de seguridad BTI94/1N

**ACCESORIOS OPCIONALES**

- Gama completa de cilindros (ver página 128 - 148)

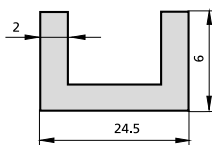
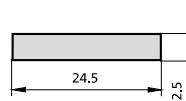
**FRENTE U**

**FRENTE LISO**

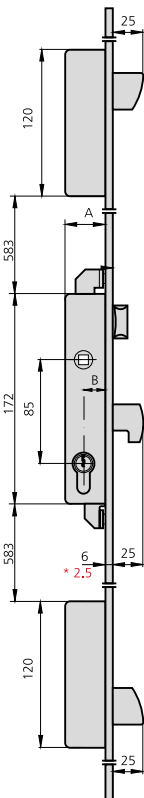
DESCRIPCIÓN	REF.	MEDIDAS		LEVA	ACABADOS		UDS	
		B	A		FRENTE	CILINDRO		
<b>FRENTE U</b> <ul style="list-style-type: none"> <li>• Picaporte y palanca</li> <li>• Cilindro 6982/2525/4</li> <li>• Cerradero CE1994/6</li> <li>• Cerradero alto/bajo CE2994S/6</li> <li>• Escudo de seguridad BTI94/1N</li> </ul>	2994/25/6U	18	33	15	AI	CN	1	
	2994/30/6U	23	38	15	AI	CN	1	
	2994/35/6U	28	43	15	AI	CN	1	
<b>FRENTE LISO</b> <ul style="list-style-type: none"> <li>• Picaporte y palanca</li> <li>• Cilindro 6982/2525/4</li> <li>• Cerradero CE1994/6</li> <li>• Cerradero alto/bajo CE2994S/6</li> <li>• Escudo de seguridad BTI94/1N</li> </ul>	2994/25/6L	22	37	15	AI	CN	1	
	2994/30/6L	27	42	15	AI	CN	1	
	2994/35/6L	32	47	15	AI	CN	1	

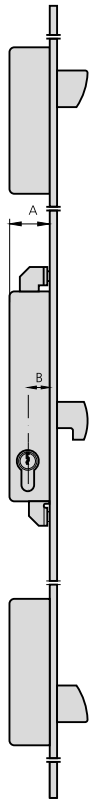

\* Medidas en frente liso



**FRENTE U**

- Sólo palanca
- Cilindro 6982/2525/4
- Cerradero CE1994/6
- Cerradero alto/bajo CE2994S/6
- Escudo de seguridad BT194/1N

REF.	MEDIDAS		LEVA	ACABADOS		UDS
	B	A		FRENTE	CILINDRO	
2994A25/6U	18	33	15	AI	CN	1
2994A30/6U	23	38	15	AI	CN	1
2994A35/6U	28	43	15	AI	CN	1

**FRENTE LISO**

- Sólo palanca
- Cilindro 6982/2525/4
- Cerradero CE1994/6
- Cerradero alto/bajo CE2994S/6
- Escudo de seguridad BT194/1N

2994A25/6L	22	37	15	AI	CN	1
2994A30/6L	27	42	15	AI	CN	1
2994A35/6L	32	47	15	AI	CN	1

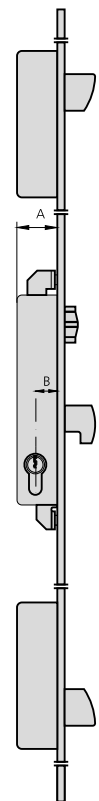

**FRENTE U**

- Rodillo vaivén regulable y palanca
- Cilindro 6982/2525/4
- Cerraderos CE1994/6
- Cerraderos alto/bajo CE2994S/6
- Escudo de seguridad BT194/1N

2994V25/6U	18	33	15	AI	CN	1
2994V30/6U	23	38	15	AI	CN	1
2994V35/6U	28	43	15	AI	CN	1

**FRENTE LISO**

- Rodillo vaivén regulable y palanca
- Cilindro 6982/2525/4
- Cerraderos CE1994/6
- Cerraderos alto/bajo CE2994S/6
- Escudo de seguridad BT194/1N

2994V25/6L	22	37	15	AI	CN	1
2994V30/6L	27	42	15	AI	CN	1
2994V35/6L	32	47	15	AI	CN	1

**CARACTERÍSTICAS**

- Cerradura de 3 puntos mediante barra roscada de M8
- Frente de acero inoxidable
- Caja bicromatada
- Palanca basculante de gancho
- Picaporte reversible
- Cuadradillo de 8 mm

- Cilindro de seguridad
- Tornillo de fijación de cilindro
- Cerradero según cerradura
- Escudo de seguridad ref. BT194/1N

**ACCESORIOS OPCIONALES**

- Gama completa de cilindros (ver página 128 - 148)

**FRENTE U**

**FRENTE LISO**

DESCRIPCIÓN	REF.	MEDIDAS		LEVA	ACABADOS		UDS	
		B	A		FRENTE	CILINDRO		

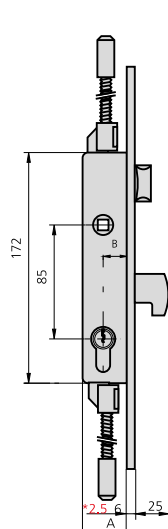

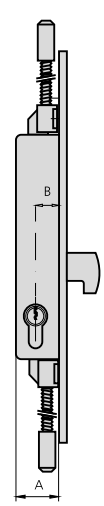

<b>FRENTE U</b>	• Picaporte y palanca	3994/25/6U	18	33	15	AI	CN	1	10
	• Cilindro 6982/2525/4	3994/30/6U	23	38	15	AI	CN	1	10
	• Cerradero CE1994/6	3994/35/6U	28	43	15	AI	CN	1	10
	• Escudo de seguridad BT194/1N								
<b>FRENTE LISO</b>	• Picaporte y palanca	3994/25/6L	22	37	15	AI	CN	1	10
	• Cilindro 6982/2525/4	3994/30/6L	27	42	15	AI	CN	1	10
	• Cerradero CE1994/6	3994/35/6L	32	47	15	AI	CN	1	10
	• Escudo de seguridad BT194/1N								

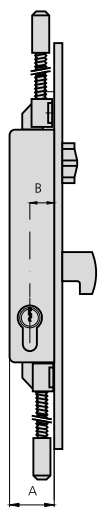

<b>FRENTE U</b>	• Sólo palanca	3994A25/6U	18	33	15	AI	CN	1	10
	• Cilindro 6982/2525/4	3994A30/6U	23	38	15	AI	CN	1	10
	• Cerradero CE1994/6	3994A35/6U	28	43	15	AI	CN	1	10
	• Escudo de seguridad BT194/1N								
<b>FRENTE LISO</b>	• Sólo palanca	3994A25/6L	22	37	15	AI	CN	1	10
	• Cilindro 6982/2525/4	3994A30/6L	27	42	15	AI	CN	1	10
	• Cerradero CE1994/6	3994A35/6L	32	47	15	AI	CN	1	10
	• Escudo de seguridad BT194/1N								



DESCRIPCIÓN	REF.	MEDIDAS		LEVA	ACABADOS		UDS	
		B	A		FRENTE	CILINDRO		
<ul style="list-style-type: none"> <li>Rodillo vaivén regulable y palanca</li> <li>Cilindro 6982/2525/4</li> <li>Cerradero CE1994/6</li> <li>Escudo de seguridad BT194/1N</li> </ul>	3994V25/6U	18	33	15	Al	CN	1	10
	3994V30/6U	23	38	15	Al	CN	1	10
	3994V35/6U	28	43	15	Al	CN	1	10

<ul style="list-style-type: none"> <li>Rodillo vaivén regulable y palanca</li> <li>Cilindro 6982/2525/4</li> <li>Cerradero CE1994/6</li> <li>Escudo de seguridad BT194/1N</li> </ul>	3994V25/6L	22	37	15	Al	CN	1	10
	3994V30/6L	27	42	15	Al	CN	1	10
	3994V35/6L	32	47	15	Al	CN	1	10

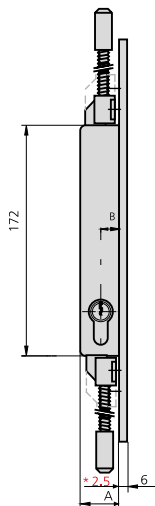

<ul style="list-style-type: none"> <li>Sin palanca y sin picaporte</li> <li>Cilindro 6982/2525/4</li> <li>Escudo de seguridad BT194/1N</li> </ul>	3994F25/6U	18	33	15	Al	CN	1	10
	3994F30/6U	23	38	15	Al	CN	1	10
	3994F35/6U	28	43	15	Al	CN	1	10

<ul style="list-style-type: none"> <li>Sin palanca y sin picaporte</li> <li>Cilindro 6982/2525/4</li> <li>Escudo de seguridad BT194/1N</li> </ul>	3994F25/6L	22	37	15	Al	CN	1	10
	3994F30/6L	27	42	15	Al	CN	1	10
	3994F35/6L	32	47	15	Al	CN	1	10

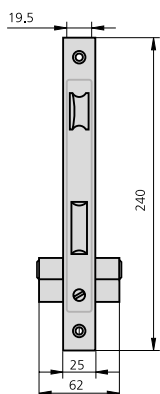

**CARACTERÍSTICAS**

- Frente de acero inoxidable
- Caja bicromatada
- Palanca deslizante
- Picaporte reversible
- Cuadradillo de 8 mm
- Cilindro europerfil
- 2 escudos de nylon ref. ES1984
- Tornillo de fijación de cilindro

**ACCESORIOS OPCIONALES**

- Cerraderos según cerradura (ver abajo)
- Gama completa de cilindros (ver página 128 - 148)

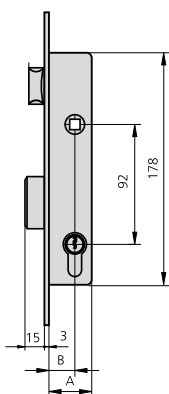
DESCRIPCIÓN	REF.	MEDIDAS		LEVA	ACABADOS		UDS	
		B	A		FRENTE	CILINDRO		



- Picaporte y palanca
- Cilindro 5990/2525

1992/20/6	20	33	13,25	Al	CN	1	20
1992/25/6	25	38	13,25	Al	CN	1	20
1992/30/6	30	43	13,25	Al	CN	1	20

**Opciones de cerradero**

- CE1984/6

**Opciones cerraderos eléctricos**

- CELC45/6A o CELC45 /6AD

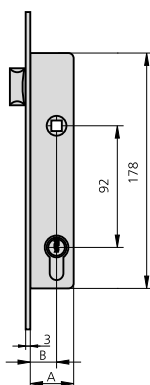

- Sólo picaporte
- Cilindro 5982T40/4

1992T20/6	20	33	15	Al	CN	1	20
1992T25/6	25	38	15	Al	CN	1	20
1992T30/6	30	43	15	Al	CN	1	20

**Opciones cerraderos eléctricos**

- CELC45T/6A o CELC45T/6AD

**PALANCA DESLIZANTE ENTRE EJES 70 CILINDRO EUROPERFIL**

**SERIE 1983**

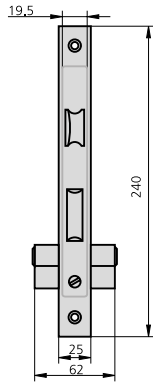

**CARACTERÍSTICAS**

- Frente hierro niquelado o acero inoxidable
- Caja bicromatada
- Palanca deslizante
- Picaporte reversible
- Cuadradillo de 8 mm
- Cilindro europerfil
- 2 escudos de nylon ref. ES1984
- Tornillo de fijación de cilindro

**ACCESORIOS OPCIONALES**

- Cerraderos según cerradura (ver abajo)
- Gama completa de cilindros (ver página 128 - 148)

DESCRIPCIÓN	REF.	MEDIDAS		LEVA	ACABADOS		UDS	
		B	A		FRENTE	CILINDRO		

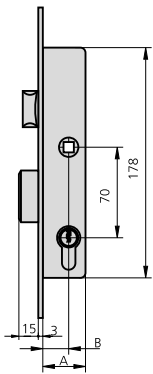

• Picaporte y palanca	1983/20/0	20	33	13,25	HN	CN	1	20
• Cilindro 5990/2525	1983/20/5	20	33	13,25	HN	CL	1	20
	1983/20/6	20	33	13,25	Al	CN	1	20
<b>Opciones de cerradero</b>	1983/25/0	25	38	13,25	HN	CN	1	20
• CE1983/6	1983/25/5	25	38	13,25	HN	CL	1	20
<b>Opciones cerraderos eléctricos</b>	1983/25/6	25	38	13,25	Al	CN	1	20
• CELC45/6A o CELC45/6AD	1983/30/0	30	43	13,25	HN	CN	1	20
	1983/30/5	30	43	13,25	HN	CL	1	20
	1983/30/6	30	43	13,25	Al	CN	1	20

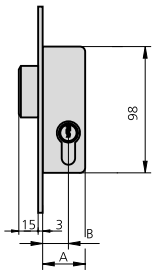

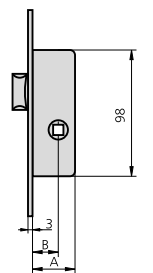

• Sólo palanca	1983A20/0	20	33	13,25	HN	CN	1	30
• Cilindro 5990/2525	1983A20/5	20	33	13,25	HN	CL	1	30
	1983A25/0	25	38	13,25	HN	CN	1	30
<b>Opciones de cerradero</b>	1983A25/5	25	38	13,25	HN	CL	1	30
• CE2994S/6	1983A30/0	30	43	13,25	HN	CN	1	30
	1983A30/5	30	43	13,25	HN	CL	1	30



• Cerradura de sólo picaporte	1983R20/0	20	33		HN		2	60
	1983R25/0	25	38		HN		2	60
• Sin cilindro	1983R30/0	30	43		HN		2	60
<b>Opciones de cerradero</b>								
• CE1991/0								



DESCRIPCIÓN	REF.	MEDIDAS		LEVA	ACABADOS		UDS	
		B	A		FRENTE	CILINDRO		

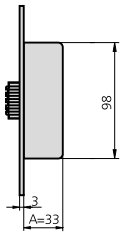

- Cerradura de sólo vaivén
- Sin cilindro

1983RV/0	33	HN	2	60
----------	----	----	---	----

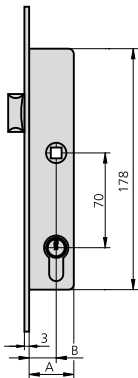

- Sólo picaporte
- Cilindro 5982T40/4

1983T20/6	20	33	15	Al	CN	1	20
1983T25/6	25	38	15	Al	CN	1	20
1983T30/6	30	43	15	Al	CN	1	20

**Opciones de cerraderos eléctricos**

- CELC45T/6A o CELC45T/6AD

**PALANCA DESLIZANTE ENTRE EJES 85 CILINDRO OVALADO MONOBLOCK**

**SERIE 1963**

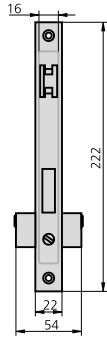

**CARACTERÍSTICAS**

- Frente de hierro niquelado o acero inoxidable
- Caja bicromatada
- Palanca deslizante
- Picaporte reversible
- Cuadradillo de 8 mm
- Cilindro ovalado monoblock (5963)
- 2 escudos de nylon ref. ES1963
- Tornillo de fijación de cilindro

**ACCESORIOS OPCIONALES**

- Cerraderos según cerradura (ver abajo)
- Cilindros (ver página 144)

DESCRIPCIÓN	REF.	MEDIDAS		LEVA	ACABADOS		UDS	
		B	A		FRENTE	CILINDRO		

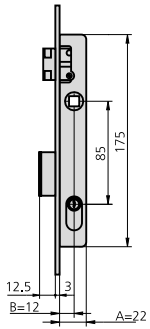

- Picaporte y palanca
- Cilindro 5963/2222

1963/0	12	22	HN	CN	1	20
1963/5	12	22	HN	CL	1	20
1963/6	12	22	AI	CN	1	20

- Opciones de cerradero**
- CE1984/0 o CE1984/6

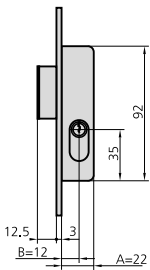

- Cerradura de sólo palanca
- Cilindro 5963/2222

1963A/0	12	22	HN	CN	1	30
1963A/5	12	22	HN	CL	1	30
1963A/6	12	22	AI	CN	1	30

- Opciones de cerradero**
- CE2994S/6

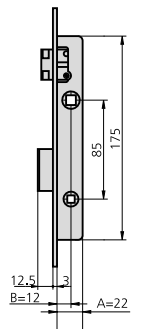

- Cerradura de condena
- Sin cilindro

1963C/6	12	22	AI		2	40
---------	----	----	----	--	---	----

- Opciones de cerradero**
- CE1984/6

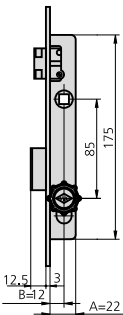
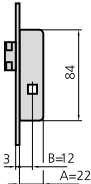
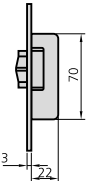
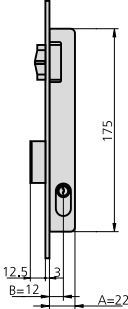
DESCRIPCIÓN	REF.	MEDIDAS		LEVA	ACABADOS		UDS	
		B	A		FRENTE	CILINDRO		
 <ul style="list-style-type: none"> <li>• Cerradura de pomo condensa</li> <li>• Sin cilindro</li> </ul> <p><b>Opciones de cerradero</b></p> <ul style="list-style-type: none"> <li>• CE1984/6</li> </ul>	1963CP16/6	12	22		Al		1	20
 <ul style="list-style-type: none"> <li>• Cerradura de sólo picaporte</li> <li>• Sin cilindro</li> </ul> <p><b>Opciones de cerradero</b></p> <ul style="list-style-type: none"> <li>• CE196R/6L</li> </ul>	1963R/0	12	22		HN		2	60
 <ul style="list-style-type: none"> <li>• Cerradura de sólo vaivén</li> <li>• Sin cilindro</li> </ul> <p><b>Opciones de cerradero</b></p> <ul style="list-style-type: none"> <li>• CE196R/6L</li> </ul>	1963RV/0		22		HN		2	60
 <ul style="list-style-type: none"> <li>• Rodillo vaivén regulable y palanca</li> <li>• Cilindro 5963/2222</li> </ul> <p><b>Opciones de cerradero</b></p> <ul style="list-style-type: none"> <li>• CE1984/0 o CE1984/6</li> </ul>	1963V/0 1963V/5 1963V/6	12 12 12	22 22 22		HN HN Al	CN CL CN	1 1 1	20 20 20

**PALANCA DESLIZANTE ENTRE EJES 85 CILINDRO OVALADO MONOBLOCK**

**SERIE 1975**

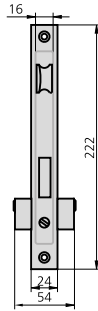

**CARACTERÍSTICAS**

- Frente de hierro niquelado
- Caja bicromatada
- Palanca deslizante
- Picaporte reversible
- Cuadradillo de 8 mm
- Cilindro ovalado monoblock (5963)
- 2 escudos de nylon ref. ES1963
- Tornillo de fijación de cilindro

**ACCESORIOS OPCIONALES**

- Cerraderos según cerradura (ver abajo)
- Cilindros (ver página 144)

DESCRIPCIÓN	REF.	MEDIDAS		LEVA	ACABADOS		UDS	
		B	A		FRENTE	CILINDRO		

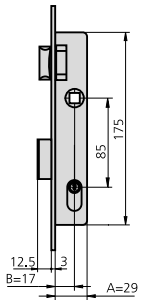

- Picaporte y palanca
- Cilindro 5963/2222

1975/0	17	29	HN	CN	1	20
1975/5	17	29	HN	CL	1	20

- Opciones de cerradero**
- CE1984/0

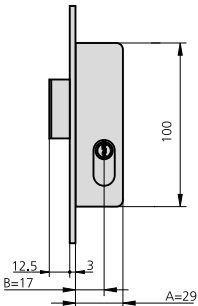

- Sólo palanca
- Cilindro 5963/2222

1975A/0	17	29	HN	CN	1	30
1975A/5	17	29	HN	CL	1	30

- Opciones de cerradero**
- CE2994S/6

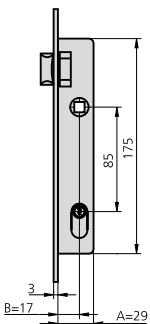

- Sólo picaporte
- Cilindro 5963T36

1975T/0	17	29	HN	CN	1	20
1975T/5	17	29	HN	CL	1	20

- Opciones de cerradero**
- CEC41T/6A o CEC41T/6AD

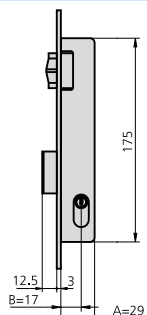

- Rodillo vaivén regulable y palanca
- Cilindro 5963/2222

1975V/0	17	29	HN	CN	1	20
1975V/5	17	29	HN	CL	1	20

- Opciones de cerradero**
- CE1984/0

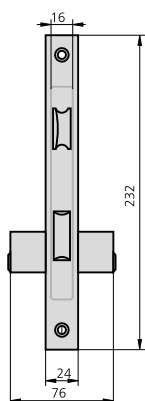



**CARACTERÍSTICAS**

- Frente de hierro niquelado o acero inoxidable
- Caja bicromatada
- Palanca deslizante
- Picaporte reversible
- Cuadradillo de 8 mm
- Cilindro ovalado monoblock (5964)
- 2 escudos de nylon ref. ES1964
- Tornillo de fijación de cilindro

**ACCESORIOS OPCIONALES**

- Cerraderos según cerradura (ver abajo)
- Cilindros (ver página 148)

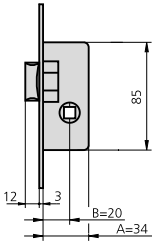
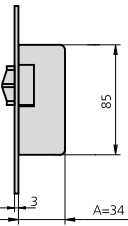
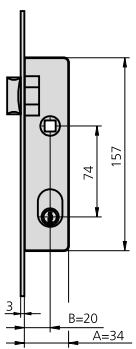
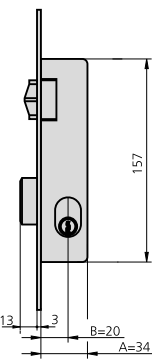
DESCRIPCIÓN	REF.	MEDIDAS		LEVA	ACABADOS		UDS	
		B	A		FRENTE	CILINDRO		
<ul style="list-style-type: none"> <li>• Picaporte y palanca</li> <li>• Cilindro ovalado 5964/2525</li> </ul> <p><b>Opciones de cerradero</b></p> <ul style="list-style-type: none"> <li>• CE1984/0 o CE1984/6</li> </ul>	1964/0	20	34	HN	CN	1	20	
	1964/5	20	34	HN	CL	1	20	
	1964/6	20	34	AI	CN	1	20	
<ul style="list-style-type: none"> <li>• Cerradura de sólo palanca</li> <li>• Cilindro ovalado 5964/2525</li> </ul> <p><b>Opciones de cerradero</b></p> <ul style="list-style-type: none"> <li>• CE2994S/6</li> </ul>	1964A/0	20	34	HN	CN	1	30	
	1964A/5	20	34	HN	CL	1	30	
<ul style="list-style-type: none"> <li>• Cerradura de condena</li> <li>• Sin cilindro</li> </ul> <p><b>Opciones de cerradero</b></p> <ul style="list-style-type: none"> <li>• CE1984/0 o CE1984/6</li> </ul>	1964C/0	20	34	HN		2	40	
	1964C/6	20	34	AI		2	40	
<ul style="list-style-type: none"> <li>• Cerradura de pomo condena</li> <li>• Sin cilindro</li> </ul> <p><b>Opciones de cerradero</b></p> <ul style="list-style-type: none"> <li>• CE1984/6</li> </ul>	1964CP/6	20	34	AI		1	20	

DESCRIPCIÓN	REF.	MEDIDAS		LEVA	ACABADOS		UDS	
		B	A		FRENTE	CILINDRO		
 <ul style="list-style-type: none"> <li>Cerradura de sólo picaporte</li> <li>Sin cilindro</li> </ul> <p><b>Opciones de cerradero</b></p> <ul style="list-style-type: none"> <li>CE196R/6L</li> </ul>	1964R/0	20	34	HN		2	60	
 <ul style="list-style-type: none"> <li>Cerradura de sólo vaivén</li> <li>Sin cilindro</li> </ul> <p><b>Opciones de cerradero</b></p> <ul style="list-style-type: none"> <li>CE1975R/0</li> </ul>	1964RV/0		34	HN		2	60	
 <ul style="list-style-type: none"> <li>Cerradura de sólo picaporte</li> <li>Cilindro 5964T25</li> </ul> <p><b>Opciones de cerraderos eléctricos</b></p> <ul style="list-style-type: none"> <li>CEC41T/6A o CEC41T/6AD</li> </ul>	1964T/0 1964T/5 1964T/6	20 20 20	34 34 34	HN HN AI	CN CL CN	1 1 1	20 20 20	
 <ul style="list-style-type: none"> <li>Rodillo vaivén regulable y palanca</li> <li>Cilindro 5964/2525</li> </ul> <p><b>Opciones de cerradero</b></p> <ul style="list-style-type: none"> <li>CE1984/0 o CE1984/6</li> </ul>	1964V/0 1964V/5 1964V/6	20 20 20	34 34 34	HN HN AI	CN CL CN	1 1 1	20 20 20	

**CARACTERÍSTICAS**

- Frente de hierro niquelado
- Caja bicromatada
- Picaporte extensible y reversible
- Accionamiento extensible con llave
- Accionamiento del picaporte con llave y manilla
- Cuadradillo de 8 mm
- Cilindro ovalado monoblock (5081) o cilindro redondo monoblock (5181)
- 2 escudos de nylon ref. ES1964 ó ES1962/4
- Tornillo de fijación de cilindro
- Cerradero CE1991/0

**ACCESORIOS OPCIONALES**

- Cilindro (ver página 145)

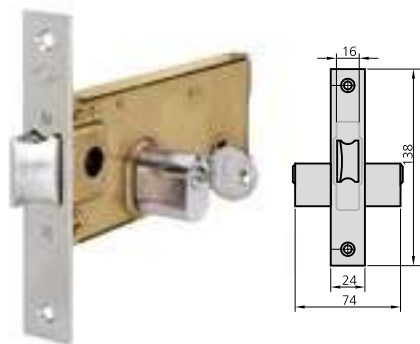

DESCRIPCIÓN	REF.	MEDIDAS		LEVA	ACABADOS		UDS	
		B	A		FRENTE	CILINDRO		

**CILINDRO OVALADO**

- Cilindro ovalado 5081/3030
- Cerradero CE1991/0
- Escudo de nylon ES1964

1981/60/0	57	152	HN	CN	1	20
1981/60/5	57	152	HN	CL	1	20

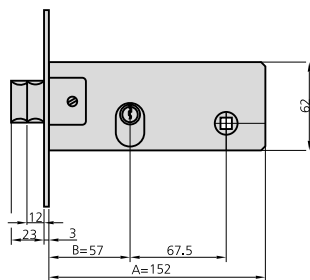
**CILINDRO REDONDO**

- Cilindro redondo 5181/3030
- Cerradero CE1991/0
- Escudo ES1962/4

11981/60/0	57	152	HN	CN	1	20
11981/60/5	57	152	HN	CL	1	20

**CILINDRO OVALADO**

- Vaivén extensible
- Cilindro ovalado 5081/3030
- Cerradero CE1991/0
- Escudo de nylon ES1964

1981V60/0	57	152	HN	CN	1	20
1981V60/5	57	152	HN	CL	1	20

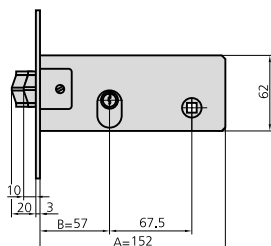

**CILINDRO REDONDO**

- Vaivén extensible
- Cilindro redondo 5181/3030
- Cerradero CE1991/0
- Escudo ES1962/4

11981V60/0	57	152	HN	CN	1	20
11981V60/5	57	152	HN	CL	1	20

**CERRADURA PARA PUERTAS DE ZÓCALO CON CILINDRO EUROPERFIL**

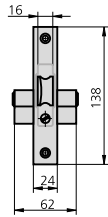
**SERIE 1991**





**CARACTERÍSTICAS**

- Frente de hierro niquelado
- Caja bicromatada
- Picaporte extensible y reversible
- Accionamiento extensible con llave
- Accionamiento del picaporte con llave y manilla
- Cuadradillo de 8 mm
- Cilindro europerfil
- 2 escudos de nylon ref. ES1984
- Tornillo de fijación de cilindro
- Cerradero CE1991/0

**ACCESORIOS OPCIONALES**

- Gama completa de cilindros (ver página 128 - 148)

DESCRIPCIÓN	REF.	MEDIDAS		LEVA	ACABADOS		UDS	
		B	A		FRENTE	CILINDRO		
• Picaporte extensible y reversible	1991/60/0	58	149	15	HN	CN	1	20
• Cilindro europerfil 5982/2525	1991/60/5	58	149	15	HN	CL	1	20
• Cerradero CE1991/0	1991/70/0	68	159	15	HN	CN	1	20
	1991/70/5	68	159	15	HN	CL	1	20

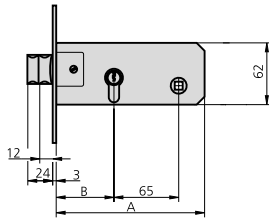



### CARACTERÍSTICAS

- Frente de hierro niquelado
- Caja bicromatada
- Palanca de gancho
- Cilindro ovalado monoblock de vástagos
- 2 escudos de nylon ref. ES1964
- Tornillo de fijación de cilindro

### ACCESORIOS OPCIONALES

DESCRIPCIÓN	REF.	MEDIDAS		LEVA	ACABADOS		UDS	
		B	A		FRENTE	CILINDRO		
<ul style="list-style-type: none"> <li>• Cerradura con palanca basculante de gancho</li> <li>• Cilindro 5968/2525</li> </ul>	1968/0	17	34	HN	CN	1	20	
	1968/5	17	34	HN	CL	1	20	

**CERRADURA DE SÓLO GANCHO CON CILINDRO EUROPERFIL**

**SERIE 1982**

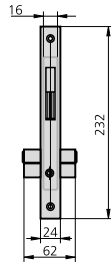

**CARACTERÍSTICAS**

- Frente de hierro niquelado
- Caja bicromatada
- Palanca de gancho
- Cilindro europerfil
- 2 escudos de nylon ref. ES1984
- Tornillo de fijación de cilindro

**ACCESORIOS OPCIONALES**

- Gama completa de cilindros (ver página 128 - 148)

DESCRIPCIÓN	REF.	MEDIDAS		LEVA	ACABADOS		UDS	
		B	A		FRENTE	CILINDRO		
<ul style="list-style-type: none"> <li>• Cerradura con palanca basculante de gancho</li> <li>• Cilindro 5982/2525</li> </ul>	1982/0	17	34	HN	CN	1	20	
	1982/5	17	34	HN	CL	1	20	

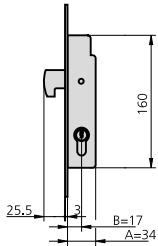

**CARACTERÍSTICAS**

- Frente de hierro niquelado
- Caja bicromatada
- Picaporte reversible accionado con llave por el exterior y con pomo por el interior o accionamiento con llave por ambos lados
- Cilindro ovalado monoblock de vástagos
- 2 escudos de nylon ref. ES1964
- Tornillo de fijación de cilindro

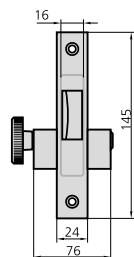
**ACCESORIOS OPCIONALES**

DESCRIPCIÓN	REF.	MEDIDAS		LEVA	ACABADOS		UDS	
		B	A		FRENTE	CILINDRO		

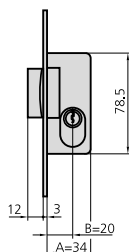

- Picaporte reversible accionado con llave por el exterior y pomo por el interior
- 5979P3030

1979P/0	20	34	HN	CN	1	30
1979P/5	20	34	HN	CL	1	30

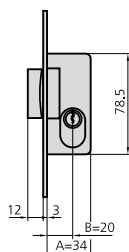

- Picaporte reversible accionado con llave por el exterior y por el interior
- 5979/3030

1979/0	20	34	HN	CN	1	30
1979/5	20	34	HN	CL	1	30

**CERRADURA PARA PUERTAS Y PERSIANAS METÁLICAS ENROLLABLES**

**SERIE 11A**

**CARACTERÍSTICAS**

- Cerradura para puertas metálicas enrollables
- Accionamiento exterior e interior mediante llave
- Caja bicromatada
- Cilindro redondo de 3 pitones

**ACCESORIOS OPCIONALES**

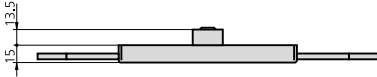

DESCRIPCIÓN	REF.	MEDIDAS		LEVA	ACABADOS		UDS	
		B	A		FRENTE	CILINDRO		
<ul style="list-style-type: none"> <li>• Dos puntos de cierre laterales</li> </ul>	11A	60	154		CL		1	24
<ul style="list-style-type: none"> <li>• Dos puntos de cierre laterales y un punto inferior</li> </ul>	11A/3P	60	154		CL		1	

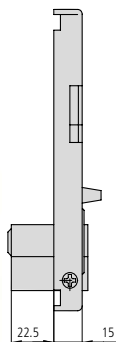

**CARACTERÍSTICAS**

- Accionamiento mediante manilla.
- Bloqueo interior mediante botón, bloqueo exterior mediante llave
- 2 puntos de cierre horizontales
- Caja bicromatada
- Medio cilindro monoblock ref. 5982T40/3
- Opcionalmente con set de escudo y manillas (ref. 11B/M)
- 1 Escudo ref. ES1960

**ACCESORIOS OPCIONALES**

- Gama completa de cilindros (ver página 128 - 148)

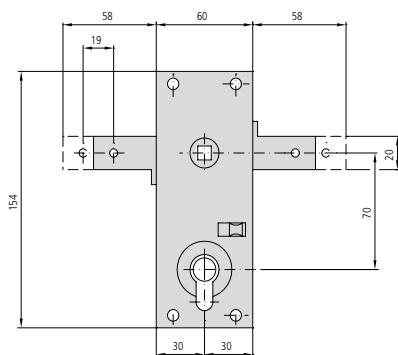
DESCRIPCIÓN	REF.	MEDIDAS		LEVA	ACABADOS		UDS	
		B	A		FRENTE	CILINDRO		
• Dos puntos de cierre horizontales	11B	60	154	15	CL		1	40
• Medio cilindro monoblock 5982T40/3	11B/M	60	154	15	CL		1	40



ACCESORIOS

CERRADEROS PARA CERRADURAS METÁLICAS

DESCRIPCIÓN	REF.	ACABADO	APLICABLE A CERRADURAS	UDS
-------------	------	---------	------------------------	-----

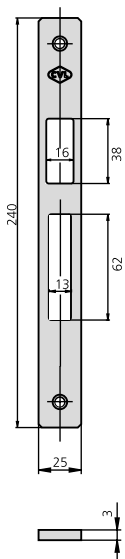

CE1983/6    Al    1983

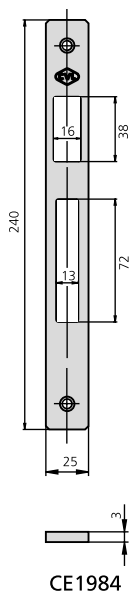

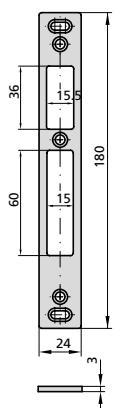

CE1984/0    HN  
 CE1984/6    Al    1984, 1992, 1995,  
 1964, 1963, 1975



CE190/0    HN    190  
 CE190/6    Al    190

**ACCESORIOS**

**CERRADEROS PARA CERRADURAS METÁLICAS**

DESCRIPCIÓN	REF.	ACABADO	APLICABLE A CERRADURAS	UDS  
-------------	------	---------	------------------------	---

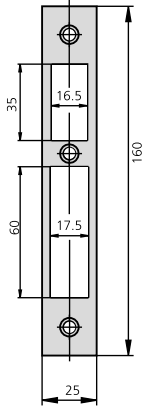

CE1990/0    HN    1990

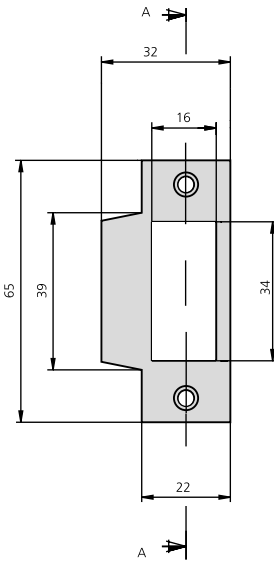
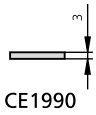

CE1991/0    HN    1991, 1981, 11981

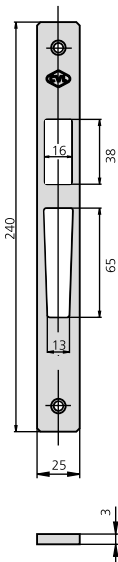

CE1994/6    Al    1994, 2994, 3994

ACCESORIOS

CERRADEROS PARA CERRADURAS METÁLICAS

DESCRIPCIÓN	REF.	ACABADO	APLICABLE A CERRADURAS	UDS 
-------------	------	---------	------------------------	---

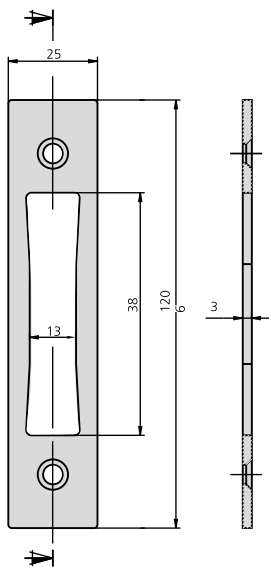

CE2994S/6    AI    1983A, 1963A, 1975A, 1995A, arriba/abajo 2994

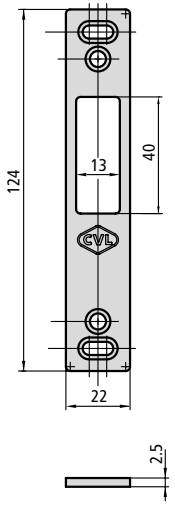

CE196R/6L    AI    1963R, 1964R, 1983R, 1995R

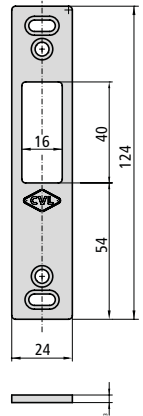

CE1975R/0    HN    1975R, 1979R, 1984T, 1983T, 1992T, 1964RV



DESCRIPCIÓN	REF.	APLICABLE A CERRADURAS	UDS  
-------------	------	------------------------	---

- Cerradero eléctrico regulable reversible con funcionamiento automático
- Frente plano inox
- 12V / corriente alterna

CELC45/6A

1995, 1992, 1984, 190, 1990, 1994, 1983

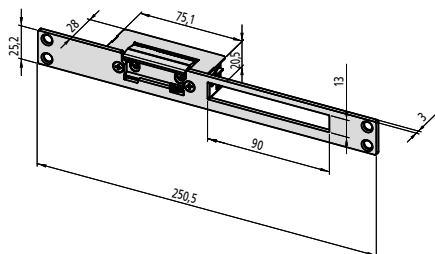

- Cerradero eléctrico regulable reversible con funcionamiento automático y con desbloqueo
- Frente plano inox
- 12V / corriente alterna

CELC45/6AD

1995, 1992, 1984, 190, 1990, 1994, 1983

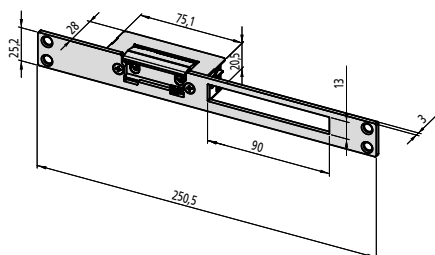

- Cerradero eléctrico regulable reversible con funcionamiento automático
- Sólo picaporte y frente plano inox
- 12V / corriente alterna

CELC45T/6A

1995T, 1992T, 1983T, 1984T

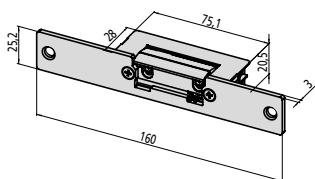

- Cerradero eléctrico regulable reversible con funcionamiento automático y con desbloqueo
- Sólo picaporte y frente plano inox
- 12V / corriente alterna

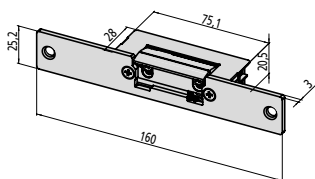

CELC45T/6AD

1995T, 1992T, 1983T, 1984T



**ACCESORIOS**

**ESCUDOS**

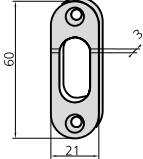
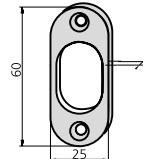
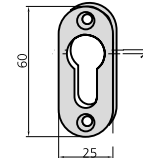
DESCRIPCIÓN	REF.	ACABADO	APLICABLE A CERRADURAS	UDS  	PRECIO COMPLETA S/CILINDRO
	ES1963	Escudo de nylon	1963, 1975		
	ES1964	Escudo de nylon	1964, 1968, 1979, 1981		
	ES1984	Escudo de nylon	1982, 1983, 1984, 1990, 1992, 1994, 1995, 196, 184, 183, 192, 194, 194, P194		

**ACCESORIOS**

**ESCUDOS DE SEGURIDAD**

DESCRIPCIÓN	REF.	ACABADO	APLICABLE A CERRADURAS	UDS  	PRECIO COMPLETA S/CILINDRO
	BTI94/1N	Negro	1983, 1984, 1990		
		NEGRO			

## CERRADURAS DE SOBREPONER

Cerradura de sobreponer serie 56	98
• Serie 56A	98
• Serie 56B	99
• Serie 56C	100
Cerradura de sobreponer serie 125	101
• Serie 125A	101
• Serie 125B	102
Cerradura de sobreponer serie 124	103
• Serie 124A	103
Cerradura de sobreponer serie 122	104
• Serie 122A	104
• Serie 122C	105
Cerradura de sobreponer serie 123	106
• Serie 123A	106
• Serie 123C	107
Cerrojos	108
• Serie 1976	108
• Serie 1978	109
• Serie 1988	110
Picaportes	111
• Serie 234	111
• Serie 236	112

## CERRADURA DE SOBREPONER SERIE 56

## SERIE 56A

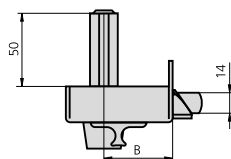

## CARACTERÍSTICAS

- Picaporte accionado por llave exteriormente y con llave y tirador desde el interior
- Palanca de una vuelta de llave accionable por ambos lados
- Posibilidad de elección entre cilindro de perfil o cilindro redondo
- Dos acabados: hierro esmaltado y hierro niquelado
- Cerradero según cerradura
- Embellecedor según tipo de cilindro
- Componentes de sujeción

## ACCESORIOS OPCIONALES

- Cilindro de seguridad

DESCRIPCIÓN	REF.	MEDIDAS		CILINDRO	ACABADOS		UDS	
		B	A		FRENTE	CILINDRO		
• Cilindro perfil ref. 5056/50/3	56A60D/0 56A60I/0	35	60	5056/50/3	HN	CL	1	24
• Cerradero ref. CE56AD o CE56AI	56A60D/1 56A60I/1	35	60	5056/50/3	HE	CL	1	24
• Embellecedor ES125	56A70D/0 56A70I/0	45	70	5056/50/3	HN	CL	1	24
<b>Opciones cerraderos eléctricos</b>	56A70D/1 56A70I/1	45	70	5056/50/3	HE	CL	1	24
• CELC56/1A o CELC56/1BA	56A70I/1	45	70	5056/50/3	HE	CL	1	24
• Cilindro redondo ref. 5156/50/3	156A60D/0 156A60I/0	35	60	5156/50/3	HN	CL	1	24
• Cerradero ref. CE56AD o CE56AI	156A60D/1 156A60I/1	35	60	5156/50/3	HE	CL	1	24
• Embellecedor ES1125	156A70D/0 156A70I/0	45	70	5156/50/3	HN	CL	1	24
<b>Opciones cerraderos eléctricos</b>	156A70D/1 156A70I/1	45	70	5156/50/3	HE	CL	1	24
• CELC56/1A o CELC56/1BA	156A70I/1	45	70	5156/50/3	HE	CL	1	24

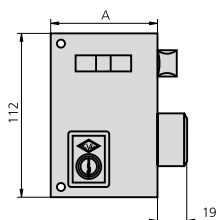

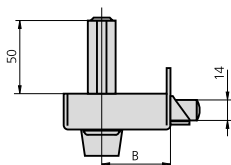

**CARACTERÍSTICAS**

- Picaporte accionado mediante manilla por ambos lados
- Palanca de una vuelta de llave accionable por ambos lados
- Posibilidad de elección entre cilindro de perfil o cilindro redondo
- Dos acabados: hierro esmaltado y hierro niquelado
- Cerradero según cerradura
- Embellecedor según tipo de cilindro
- Componentes de sujeción

**ACCESORIOS OPCIONALES**

- Cilindro de seguridad

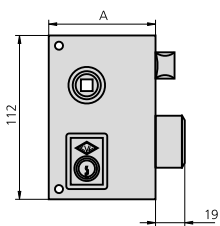
DESCRIPCIÓN	REF.	MEDIDAS		CILINDRO	ACABADOS		UDS	
		B	A		FRENTE	CILINDRO		
• Cilindro perfil ref. 5056/50/3	56B60D/0 56B60I/0	35 35	60 60	5056/50/3 5056/50/3	HN HN	CL CL	1 1	24 24
• Cerradero ref. CE56AD o CE56AI	56B60D/1 56B60I/1	35 35	60 60	5056/50/3 5056/50/3	HE HE	CL CL	1 1	24 24
• Embellecedor ES125	56BR70D/0 56BR70I/0	45 45	70 70	5056/50/3 5056/50/3	HN HN	CL CL	1 1	24 24
<b>Opciones cerraderos eléctricos</b>	56BR70D/1 56BR70I/1	45 45	70 70	5056/50/3 5056/50/3	HE HE	CL CL	1 1	24 24
• CELC56/1A o CELC56/1BA								



• Cilindro redondo ref. 5156/50/3	156B60D/0 156B60I/0	35 35	60 60	5156/50/3 5156/50/3	HN HN	CL CL	1 1	24 24
• Cerradero ref. CE56AD o CE56AI	156B60D/1 156B60I/1	35 35	60 60	5156/50/3 5156/50/3	HE HE	CL CL	1 1	24 24
• Embellecedor ES1125	156BR70D/0 156BR70I/0	45 45	70 70	5156/50/3 5156/50/3	HN HN	CL CL	1 1	24 24
<b>Opciones cerraderos eléctricos</b>	156BR70D/1 156BR70I/1	45 45	70 70	5156/50/3 5156/50/3	HE HE	CL CL	1 1	24 24
• CELC56/1A o CELC56/1BA								

## CERRADURA DE SOBREPONER SERIE 56

## SERIE 56C

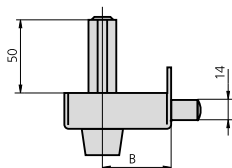

## CARACTERÍSTICAS

- Picaporte accionado por manilla por ambos lados
- Palanca de una vuelta de llave accionable por ambos lados
- Posibilidad de elección entre cilindro de perfil o cilindro redondo
- Dos acabados: hierro esmaltado y hierro niquelado
- Cerradero según cerradura
- Embellecedor según tipo de cilindro
- Componentes de sujeción

## ACCESORIOS OPCIONALES

- Cilindro de seguridad

DESCRIPCIÓN	REF.	MEDIDAS		CILINDRO	ACABADOS		UDS		
		B	A		FRENTE	CILINDRO			
<ul style="list-style-type: none"> <li>• Cilindro perfil ref. 5056/50/3</li> <li>• Cerradero ref. CE56C/1 o CE56C/0</li> <li>• Embellecedor ES125</li> </ul>	56C60D/0	35	60	5056/50/3	HN	CL	1	24	
	56C60I/0	35	60	5056/50/3	HN	CL	1	24	
	56C60D/1	35	60	5056/50/3	HE	CL	1	24	
	56C60I/1	35	60	5056/50/3	HE	CL	1	24	
	56C70D/0	45	70	5056/50/3	HN	CL	1	24	
	56C70I/0	45	70	5056/50/3	HN	CL	1	24	
	56C70D/1	45	70	5056/50/3	HE	CL	1	24	
	56C70I/1	45	70	5056/50/3	HE	CL	1	24	
	<ul style="list-style-type: none"> <li>• Cilindro redondo ref. 5156/50/3</li> <li>• Cerradero ref. CE56C/1 o CE56C/0</li> <li>• Embellecedor ES1125</li> </ul>	156C60D/0	35	60	5156/50/3	HN	CL	1	24
		156C60I/0	35	60	5156/50/3	HN	CL	1	24
156C60D/1		35	60	5156/50/3	HE	CL	1	24	
156C60I/1		35	60	5156/50/3	HE	CL	1	24	
156C70D/0		45	70	5156/50/3	HN	CL	1	24	
156C70I/0		45	70	5156/50/3	HN	CL	1	24	
156C70D/1		45	70	5156/50/3	HE	CL	1	24	
156C70I/1		45	70	5156/50/3	HE	CL	1	24	

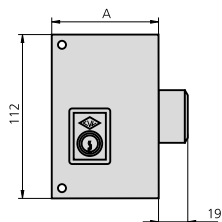

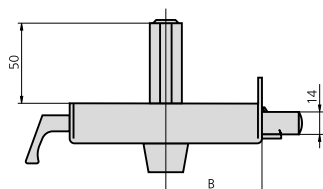

**CARACTERÍSTICAS**

- Picaporte accionado por llave exteriormente y con llave y tirador desde el interior
- Palanca de dos vueltas de llave accionable por ambos lados
- Posibilidad de elección entre cilindro de perfil o cilindro redondo
- Dos acabados: hierro esmaltado y hierro niquelado
- Cerradero según cerradura
- Embellecedor según tipo de cilindro
- Componentes de sujeción

**ACCESORIOS OPCIONALES**

- Cilindro de seguridad

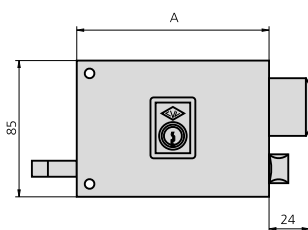
DESCRIPCIÓN	REF.	MEDIDAS		CILINDRO	ACABADOS		UDS	
		B	A		FRENTE	CILINDRO		
• Cilindro perfil ref. 5056/50/3	125A8D/0	47	90	5056/50/3	HN	CL	1	20
• Picaporte reversible en la medida de 100 mm (REF. 125AR)	125A8I/0	47	90	5056/50/3	HN	CL	1	20
• Cerradero ref. CE125AD o CE125AI	125A8D/1	47	90	5056/50/3	HE	CL	1	20
• Embellecedor ES125	125A8I/1	47	90	5056/50/3	HE	CL	1	20
<b>Opciones cerraderos eléctricos</b>	125AR10D/0	60	100	5056/50/3	HN	CL	1	20
• CELC125/1A o CELC125/1BA	125AR10I/0	60	100	5056/50/3	HN	CL	1	20
	125AR10D/1	60	100	5056/50/3	HE	CL	1	20
	125AR10I/1	60	100	5056/50/3	HE	CL	1	20
	125A12D/0	60	120	5056/50/3	HN	CL	1	20
	125A12I/0	60	120	5056/50/3	HN	CL	1	20
	125A12D/1	60	120	5056/50/3	HE	CL	1	20
	125A12I/1	60	120	5056/50/3	HE	CL	1	20
	125A14D/0	70	140	5056/50/3	HN	CL	1	20
	125A14I/0	70	140	5056/50/3	HN	CL	1	20
	125A14D/1	70	140	5056/50/3	HE	CL	1	20
	125A14I/1	70	140	5056/50/3	HE	CL	1	20
	1125A8D/0	47	90	5156/50/3	HN	CL	1	20
	1125A8I/0	47	90	5156/50/3	HN	CL	1	20
	1125A8D/1	47	90	5156/50/3	HE	CL	1	20
	1125A8I/1	47	90	5156/50/3	HE	CL	1	20
	1125AR10D/0	60	100	5156/50/3	HN	CL	1	20
	1125AR10I/0	60	100	5156/50/3	HN	CL	1	20
	1125AR10D/1	60	100	5156/50/3	HE	CL	1	20
	1125AR10I/1	60	100	5156/50/3	HE	CL	1	20
	1125A12D/0	60	120	5156/50/3	HN	CL	1	20
	1125A12I/0	60	120	5156/50/3	HN	CL	1	20
	1125A12D/1	60	120	5156/50/3	HE	CL	1	20
	1125A12I/1	60	120	5156/50/3	HE	CL	1	20
	1125A14D/0	70	140	5156/50/3	HN	CL	1	20
	1125A14I/0	70	140	5156/50/3	HN	CL	1	20
	1125A14D/1	70	140	5156/50/3	HE	CL	1	20
	1125A14I/1	70	140	5156/50/3	HE	CL	1	20



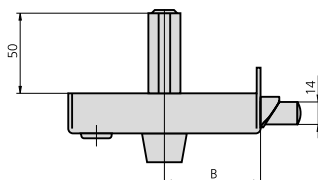

**CARACTERÍSTICAS**

- Picaporte accionado por manilla por ambos lados
- Picaporte reversible
- Palanca de dos vueltas de llave accionable por ambos lados
- Posibilidad de elección entre cilindro de perfil o cilindro redondo
- Dos acabados: hierro esmaltado y hierro niquelado
- Cerradero según cerradura
- Embellecedor según tipo de cilindro
- Componentes de sujeción

**ACCESORIOS OPCIONALES**

- Cilindro de seguridad

DESCRIPCIÓN	REF.	MEDIDAS		CILINDRO	ACABADOS		UDS	
		B	A		FRENTE	CILINDRO		
• Cilindro perfil ref. 5056/50/3	125BR12D/0	60	120	5056/50/3	HN	CL	1	24
• Picaporte reversible	125BR12I/0	60	120	5056/50/3	HN	CL	1	24
• Cerradero ref. CE125AD o CE125AI	125BR12D/1	60	120	5056/50/3	HE	CL	1	24
• Embellecedor ES125	125BR12I/1	60	120	5056/50/3	HE	CL	1	24
<b>Opciones cerraderos eléctricos</b>	125BR14D/0	70	140	5056/50/3	HN	CL	1	24
• CELC125/1A o CELC125/1BA	125BR14I/0	70	140	5056/50/3	HN	CL	1	24
	125BR14D/1	70	140	5056/50/3	HE	CL	1	24
	125BR14I/1	70	140	5056/50/3	HE	CL	1	24

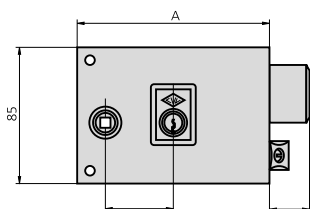

- Cilindro redondo ref. 5156/50/3
- Picaporte reversible
- Cerradero ref. CE125AD o CE125AI
- Embellecedor ES1125

**Opciones cerraderos eléctricos**

- CELC125/1A o CELC125/1BA

1125BR12D/0	60	120	5156/50/3	HN	CL	1	24
1125BR12I/0	60	120	5156/50/3	HN	CL	1	24
1125BR12D/1	60	120	5156/50/3	HE	CL	1	24
1125BR12I/1	60	120	5156/50/3	HE	CL	1	24
1125BR14D/0	70	140	5156/50/3	HN	CL	1	24
1125BR14I/0	70	140	5156/50/3	HN	CL	1	24
1125BR14D/1	70	140	5156/50/3	HE	CL	1	24
1125BR14I/1	70	140	5156/50/3	HE	CL	1	24



**CARACTERÍSTICAS**

- Palanca de dos vueltas de llave accionable por ambos lados
- Posibilidad de elección entre cilindro de perfil o cilindro redondo
- Dos acabados: hierro esmaltado y hierro niquelado
- Cerradero según cerradura
- Embellecedor según tipo de cilindro
- Componentes de sujeción

**ACCESORIOS OPCIONALES**

- Cilindro de seguridad

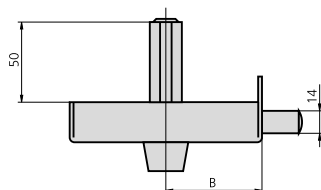

DESCRIPCIÓN	REF.	MEDIDAS		CILINDRO	ACABADOS		UDS	
		B	A		FRENTE	CILINDRO		
<ul style="list-style-type: none"> <li>• Cilindro perfil ref. 5056/50/3</li> <li>• Cerradero ref. CE125AD o CE125AI</li> <li>• Embellecedor ES125</li> </ul>	124A8D/0	47	90	5056/50/3	HN	CL	1	24
	124A8I/0	47	90	5056/50/3	HN	CL	1	24
	124A8D/1	47	90	5056/50/3	HE	CL	1	24
	124A8I/1	47	90	5056/50/3	HE	CL	1	24
	124A10D/0	60	100	5056/50/3	HN	CL	1	24
	124A10I/0	60	100	5056/50/3	HN	CL	1	24
	124A10D/1	60	100	5056/50/3	HE	CL	1	24
	124A10I/1	60	100	5056/50/3	HE	CL	1	24
	124A12D/0	60	120	5056/50/3	HN	CL	1	24
	124A12I/0	60	120	5056/50/3	HN	CL	1	24
	124A12D/1	60	120	5056/50/3	HE	CL	1	24
	124A12I/1	60	120	5056/50/3	HE	CL	1	24
	124A14D/0	70	140	5056/50/3	HN	CL	1	24
	124A14I/0	70	140	5056/50/3	HN	CL	1	24
124A14D/1	70	140	5056/50/3	HE	CL	1	24	
124A14I/1	70	140	5056/50/3	HE	CL	1	24	
<ul style="list-style-type: none"> <li>• Cilindro redondo ref. 5156/50/3</li> <li>• Cerradero ref. CE125AD o CE125AI</li> <li>• Embellecedor ES1125</li> </ul>	1124A8D/0	47	90	5156/50/3	HN	CL	1	24
	1124A8I/0	47	90	5156/50/3	HN	CL	1	24
	1124A8D/1	47	90	5156/50/3	HE	CL	1	24
	1124A8I/1	47	90	5156/50/3	HE	CL	1	24
	1124A10D/0	60	100	5156/50/3	HN	CL	1	24
	1124A10I/0	60	100	5156/50/3	HN	CL	1	24
	1124A10D/1	60	100	5156/50/3	HE	CL	1	24
	1124A10I/1	60	100	5156/50/3	HE	CL	1	24
	1124A12D/0	60	120	5156/50/3	HN	CL	1	24
	1124A12I/0	60	120	5156/50/3	HN	CL	1	24
	1124A12D/1	60	120	5156/50/3	HE	CL	1	24
	1124A12I/1	60	120	5156/50/3	HE	CL	1	24
	1124A14D/0	70	140	5156/50/3	HN	CL	1	24
	1124A14I/0	70	140	5156/50/3	HN	CL	1	24
1124A14D/1	70	140	5156/50/3	HE	CL	1	24	
1124A14I/1	70	140	5156/50/3	HE	CL	1	24	

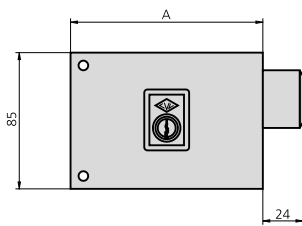

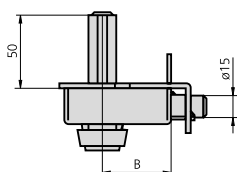

**CARACTERÍSTICAS**

- Cerradura de sobreponer reforzada
- Picaporte accionado por llave exteriormente y con llave o pomo desde el interior
- Palanca de 3 bulones de acero a dos vueltas de llave accionable por ambos lados del cilindro
- Sistema antipalanqueta
- Posibilidad de elección entre cilindro de perfil o cilindro redondo
- Dos acabados: hierro esmaltado y hierro niquelado
- Cerradero según cerradura
- Embellecedor según tipo de cilindro
- Componentes de sujeción

**ACCESORIOS OPCIONALES**

- Cilindro de seguridad

**DESCRIPCIÓN**

**REF.**

**MEDIDAS**

**CILINDRO**

**ACABADOS**

**UDS**

**B**

**A**

**FRENTE**

**CILINDRO**



- Cilindro perfil ref. 5056/50/3
- Cerradero ref. CE122AD o CE122AI
- Embellecedor ES125

122A70D/0	45	70	5056/50/3	HN	CL	1	10
122A70I/0	45	70	5056/50/3	HN	CL	1	10
122A70D/1	45	70	5056/50/3	HE	CL	1	10
122A70I/1	45	70	5056/50/3	HE	CL	1	10

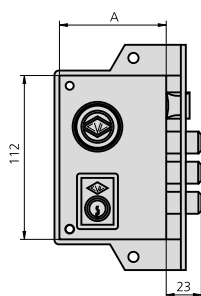

- Cilindro redondo ref. 5156/50/3
- Cerradero ref. CE122AD o CE122AI
- Embellecedor ES1125

1122A70D/0	45	70	5156/50/3	HN	CL	1	10
1122A70I/0	45	70	5156/50/3	HN	CL	1	10
1122A70D/1	45	70	5156/50/3	HE	CL	1	10
1122A70I/1	45	70	5156/50/3	HE	CL	1	10

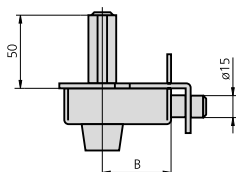
**CARACTERÍSTICAS**

- Cerradura de sobreponer reforzada
- Palanca de 4 bulones de acero a dos vueltas de llave accionable por ambos lados del cilindro
- Sistema antipalanqueta
- Posibilidad de elección entre cilindro de perfil o cilindro redondo
- Dos acabados: hierro esmaltado y hierro niquelado
- Cerradero según cerradura
- Embellecedor según tipo de cilindro
- Componentes de sujeción

**ACCESORIOS OPCIONALES**

- Cilindro de seguridad

DESCRIPCIÓN	REF.	MEDIDAS		CILINDRO	ACABADOS		UDS	
		B	A		FRENTE	CILINDRO		
<ul style="list-style-type: none"> <li>• Cilindro perfil ref. 5056/50/3</li> <li>• Cerradero ref. CE122C/1 o CE122C/0</li> <li>• Embellecedor ES125</li> </ul>	122C70D/0	45	70	5056/50/3	HN	CL	1	10
	122C70I/0	45	70	5056/50/3	HN	CL	1	10
	122C70D/1	45	70	5056/50/3	HE	CL	1	10
	122C70I/1	45	70	5056/50/3	HE	CL	1	10
<ul style="list-style-type: none"> <li>• Cilindro redondo ref. 5156/50/3</li> <li>• Cerradero ref. CE122C/1 o CE122C/0</li> <li>• Embellecedor ES1125</li> </ul>	1122C70D/0	45	70	5156/50/3	HN	CL	1	10
	1122C70I/0	45	70	5156/50/3	HN	CL	1	10
	1122C70D/1	45	70	5156/50/3	HE	CL	1	10
	1122C70I/1	45	70	5156/50/3	HE	CL	1	10

**CERRADURA DE SOBREPONER SERIE 123**

**SERIE 123A**

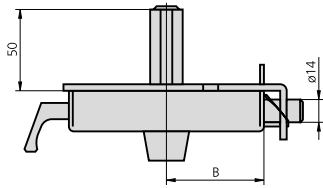

**CARACTERÍSTICAS**

- Cerradura de sobreponer reforzada
- Picaporte accionable mediante llave por el exterior y con tirador o llave desde el interior
- Palanca de 3 bulones de acero a dos vueltas de llave accionable por ambos lados del cilindro
- Sistema antipalanqueta
- Posibilidad de elección entre cilindro de perfil o cilindro redondo
- Dos acabados: hierro esmaltado y hierro niquelado
- Cerradero según cerradura
- Embellecedor según tipo de cilindro
- Componentes de sujeción

**ACCESORIOS OPCIONALES**

- Cilindro de seguridad

DESCRIPCIÓN	REF.	MEDIDAS		CILINDRO	ACABADOS		UDS	
		B	A		FRENTE	CILINDRO		
• Cilindro perfil ref. 5056/50/3	123A10D/0	60	100	5056/50/3	HN	CL	1	10
• Cerradero ref. CE123AD o CE123AI	123A10I/0	60	100	5056/50/3	HN	CL	1	10
• Embellecedor ES125	123A10D/1	60	100	5056/50/3	HE	CL	1	10
	123A10I/1	60	100	5056/50/3	HE	CL	1	10
	123A12D/0	60	120	5056/50/3	HN	CL	1	10
	123A12I/0	60	120	5056/50/3	HN	CL	1	10
	123A12D/1	60	120	5056/50/3	HE	CL	1	10
	123A12I/1	60	120	5056/50/3	HE	CL	1	10

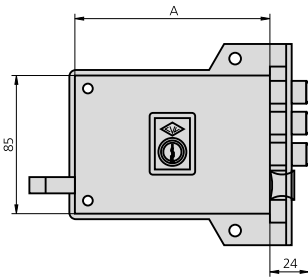

- Cilindro redondo ref. 5156/50/3
- Cerradero ref. CE123AD o CE123AI
- Embellecedor ES1125

	1123A10D/0	60	100	5156/50/3	HN	CL	1	10
	1123A10I/0	60	100	5156/50/3	HN	CL	1	10
	1123A10D/1	60	100	5156/50/3	HE	CL	1	10
	1123A10I/1	60	100	5156/50/3	HE	CL	1	10
	1123A12D/0	60	120	5156/50/3	HN	CL	1	10
	1123A12I/0	60	120	5156/50/3	HN	CL	1	10
	1123A12D/1	60	120	5156/50/3	HE	CL	1	10
	1123A12I/1	60	120	5156/50/3	HE	CL	1	10

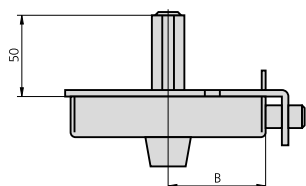
**CARACTERÍSTICAS**

- Cerradura de sobreponer reforzada
- Palanca de 4 bulones de acero a dos vueltas de llave accionable por ambos lados del cilindro
- Sistema antipalanqueta
- Posibilidad de elección entre cilindro de perfil o cilindro redondo
- Dos acabados: hierro esmaltado y hierro niquelado
- Cerradero según cerradura
- Embellecedor según tipo de cilindro
- Componentes de sujeción

**ACCESORIOS OPCIONALES**

- Cilindro de seguridad

**DESCRIPCIÓN**
**REF.**
**MEDIDAS**
**CILINDRO**
**ACABADOS**
**UDS**
**B**
**A**
**FRENTE**
**CILINDRO**

- Cilindro perfil ref. 5056/50/3
- Cerradero ref. CE123C/1 o CE123C/1
- Embellecedor ES125

123C10D/0	60	100	5056/50/3	HN	CL	1	10
123C10I/0	60	100	5056/50/3	HN	CL	1	10
123C10D/1	60	100	5056/50/3	HE	CL	1	10
123C10I/1	60	100	5056/50/3	HE	CL	1	10
123C12D/0	60	120	5056/50/3	HN	CL	1	10
123C12I/0	60	120	5056/50/3	HN	CL	1	10
123C12D/1	60	120	5056/50/3	HE	CL	1	10
123C12I/1	60	120	5056/50/3	HE	CL	1	10

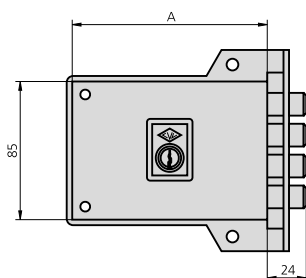

- Cilindro redondo ref. 5156/50/3
- Cerradero ref. CE123C/1 o CE123C/1
- Embellecedor ES1125

1123C10D/0	60	100	5156/50/3	HN	CL	1	10
1123C10I/0	60	100	5156/50/3	HN	CL	1	10
1123C10D/1	60	100	5156/50/3	HE	CL	1	10
1123C10I/1	60	100	5156/50/3	HE	CL	1	10
1123C12D/0	60	120	5156/50/3	HN	CL	1	10
1123C12I/0	60	120	5156/50/3	HN	CL	1	10
1123C12D/1	60	120	5156/50/3	HE	CL	1	10
1123C12I/1	60	120	5156/50/3	HE	CL	1	10

**CERROJOS**

**SERIE 1976**

**CARACTERÍSTICAS**

- Cerrojo de seguridad reversible aplicable a puertas metálicas basculantes o enrollables
- Se suministra por parejas con la misma llave
- Palanca deslizante de acero accionable por llave desde el exterior
- Cilindro exterior redondo diámetro 26 mm
- Acabado en hierro esmaltado

**ACCESORIOS OPCIONALES**

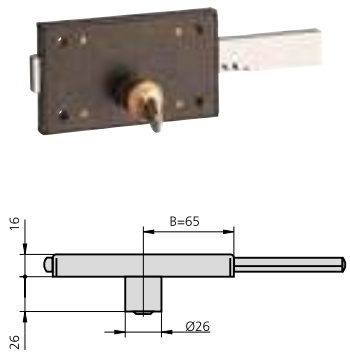

**DESCRIPCIÓN**

**REF.**

**MEDIDAS  
B A**

**CILINDRO  
Ø 26mm**

**ACABADOS  
FRENTE CILINDRO**



**UDS**

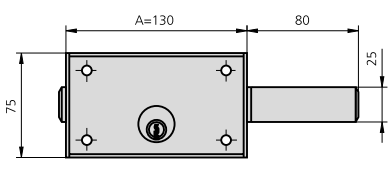

1976/1

65

130

Ø 26mm

HE

CL

1

17

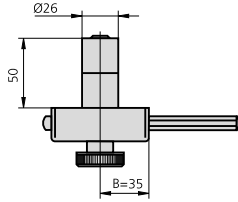
**CARACTERÍSTICAS**

- Cerrojo de seguridad reversible
- Palanca deslizante de acero accionable por llave desde el exterior y mediante pomo desde el interior
- Cilindro exterior redondo diámetro 26 mm
- Dos acabados: hierro esmaltado y hierro niquelado
- Cerradero CE1978/1 o CE1978/0
- Embellecedor ES1125
- Componentes de sujeción

**ACCESORIOS OPCIONALES**

- Cilindro de seguridad
- Cilindros de distintas longitudes

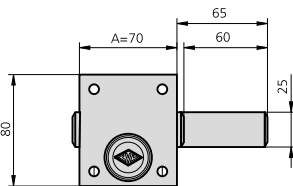
**DESCRIPCIÓN**
**REF.**
**MEDIDAS**
**CILINDRO**
**ACABADOS**
**UDS**
**B**
**A**
**FRENTE**
**CILINDRO**

1978/0

35

70

Ø 26mm

HN

CL

1

20

1978/1

35

70

Ø 26mm

HE

CL

1

20

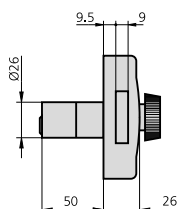

**CARACTERÍSTICAS**

- Cerrojo de seguridad reversible
- Palanca deslizante de acero accionable por llave desde el exterior y mediante pomo desde el interior
- Cilindro exterior redondo diámetro 26 mm
- Dos acabados: hierro esmaltado y hierro niquelado
- Cerradero CE1988/1 o CE1988/0
- Embellecedor ES1125
- Componentes de sujeción

**ACCESORIOS OPCIONALES**

- Cilindro de seguridad
- Cilindros de distintas longitudes

**DESCRIPCIÓN**

**REF.**

**MEDIDAS  
B A**

**CILINDRO  
Ø**

**ACABADOS  
FRENTE CILINDRO**

**UDS**



1988/0	56	Ø 26mm	HN	CL	1	24
1988/1	56	Ø 26mm	HE	CL	1	24

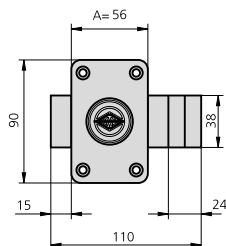



**PICAPORTES**

**SERIE 234**



**CARACTERÍSTICAS**

- Picaporte reversible de sobreponer
- Picaporte accionable mediante manilla
- Cuadradillo para manilla de 8 mm
- Acabado en hierro esmaltado
- Cerradero CE234/1
- Embellecedor ES234

**ACCESORIOS OPCIONALES**

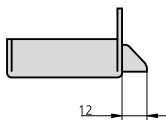

DESCRIPCIÓN	REF.	MEDIDAS		CILINDRO	ACABADOS		UDS	
		B	A		FRENTE	CILINDRO		

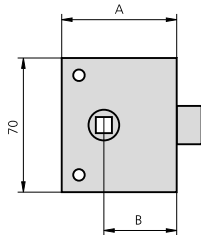

234/50/1	30	50	-	HE		6	120
234/60/1	38	60	-	HE		6	120
234/70/1	46	70	-	HE		6	120

**PICAPORTES**

**SERIE 236**

**CARACTERÍSTICAS**

- Picaporte reversible de sobreponer
- Condena accionable mediante tirador
- Cuadradillo para manilla de 8 mm
- Acabado en hierro esmaltado
- Cerradero CE236/1
- Embellecedor ES234

**ACCESORIOS OPCIONALES**

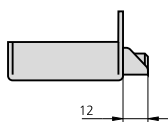

**DESCRIPCIÓN**

**REF.**

**MEDIDAS**

**CILINDRO**

**ACABADOS**

**UDS**



**B**

**A**

**FRENTE**

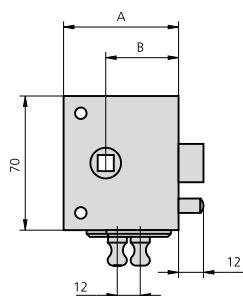
**CILINDRO**



REF.	B	A	CILINDRO	ACABADOS FRENTE CILINDRO	UDS  
236/50/1	30	50	-	HE	6 120
236/60/1	38	60	-	HE	6 120
236/70/1	46	70	-	HE	6 120

## CERRADURAS DE EMBUTIR PARA CARPINTERÍA DE MADERA

Cerraduras de seguridad con palanca de bulones	114
• Serie 4000	114
Cerradura multipunto de seguridad con palanca de bulones	115
• Serie 4100	115
Cerraduras de palanca rectangular deslizante	116
• Serie 1985N	116
• Serie 1970N	117
• Serie 1960	119
• Serie 1961	120
• Serie 1962	121
Picaportes	122
• Serie 249	122
Accesorios	123
• Cerraderos para cerraduras para puertas de madera	123
• Escudos	125
• Escudos de seguridad	125

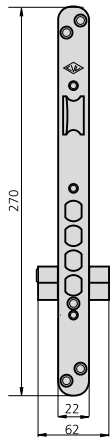
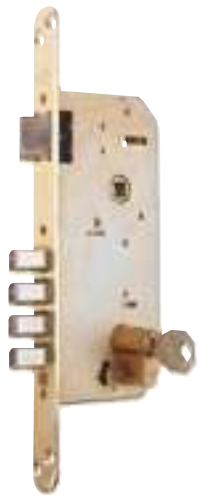

**CARACTERÍSTICAS**

- Cerradura de seguridad de 1 punto y palanca de 4 bulones de acero
- Entre ejes 85 mm
- Frente de hierro latonado o acero inoxidable disponible en canto redondo y canto cuadrado
- Picaporte reversible accionable mediante llave y manilla
- Cerradero de hierro latonado o acero inoxidable disponible en canto redondo y canto cuadrado
- Escudo protector de cilindro
- Cilindro de seguridad
- Otros acabados posibles: inox, pintado bronce ingles, pintado dorado, pintado plateado

**ACCESORIOS OPCIONALES**

- Gama completa de cilindros (ver página 128 - 148)

**DESCRIPCIÓN**

**REF.**

**MEDIDAS  
B A**

**LEVA**

**ACABADOS  
FRENTE CILINDRO**

**CANTO**



**UDS**

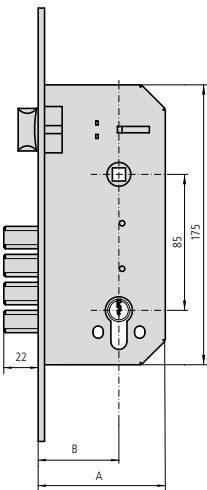

- Picaporte y palanca de 4 bulones de acero
- Cilindro de seguridad 6982/2525

4000/50/0	50	80	15	HN	CN	Red	1	12
4000/50/6	50	80	15	AI	CN	Red	1	12
4001/50/0	50	80	15	HN	CN	Cua	1	12
4001/50/6	50	80	15	AI	CN	Cua	1	12
4000/60/0	60	90	15	HN	CN	Red	1	12
4000/60/6	60	90	15	AI	CN	Red	1	12
4001/60/0	60	90	15	HN	CN	Cua	1	12
4001/60/6	60	90	15	AI	CN	Cua	1	12

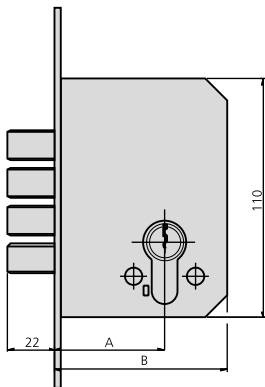

- Cerradura con sólo palanca de 4 bulones de acero
- Cilindro de seguridad 6982/2525

4000A50/0	50	80	15	HN	CN	Red	1	12
4000A50/6	50	80	15	AI	CN	Red	1	12
4001A50/0	50	80	15	HN	CN	Cua	1	12
4001A50/6	50	80	15	AI	CN	Cua	1	12
4000A60/0	60	90	15	HN	CN	Red	1	12
4000A60/6	60	90	15	AI	CN	Red	1	12
4001A60/0	60	90	15	HN	CN	Cua	1	12
4001A60/6	60	90	15	AI	CN	Cua	1	12

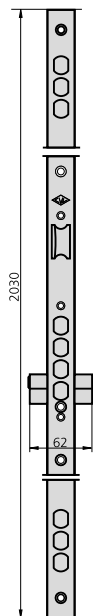
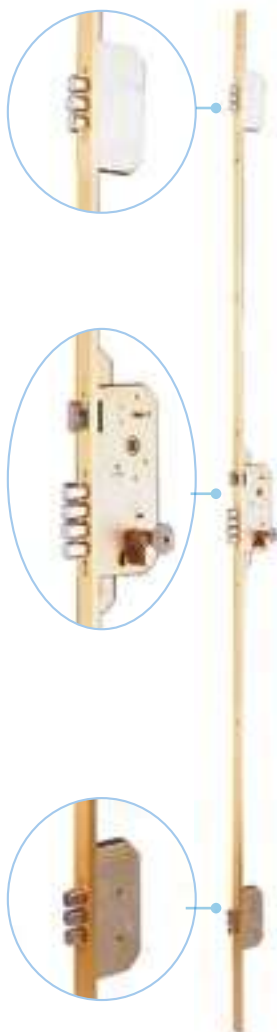
**CARACTERÍSTICAS**

- Cerradura de alta seguridad de 3 puntos de cierre mediante 10 bulones de acero
- Entre ejes 85 mm
- Frente largo de acero niquelado
- Picaporte reversible accionable mediante llave y manilla
- 3 cerraderos cortos de acero niquelado
- Escudo protector de cilindro de seguridad pintado dorado
- Cilindro de seguridad
- Otros acabados posibles: inox, pintado bronce ingles, pintado dorado, pintado plateado

**ACCESORIOS OPCIONALES**

- Gama completa de cilindros (ver página 128 - 148)

DESCRIPCIÓN	REF.	MEDIDAS		LEVA	ACABADOS		UDS	
		B	A		FRENTE	CILINDRO		

- Cerradura de 3 puntos ref. 4100/50/0
- Cilindro de seguridad ref. 6982/2525/4

4100/50/0	50	80	15	HN		1
4100/60/0	60	90	15	HN		1

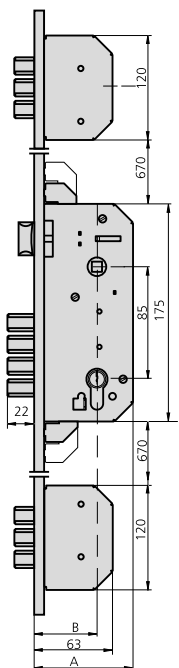

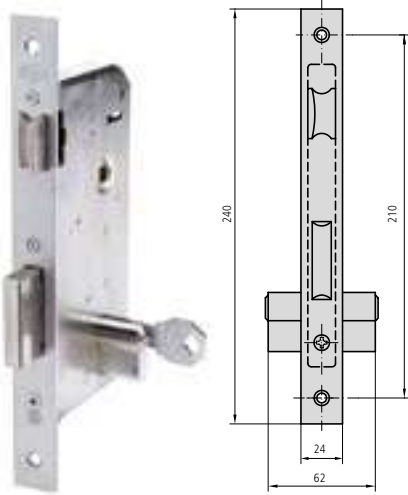

**CARACTERÍSTICAS**

- Entre ejes 85 mm
- Frente de hierro latonado o acero inoxidable
- Picaporte reversible accionable mediante llave y manilla
- Palanca deslizante a dos vueltas de llave
- Cerradero según cerradura
- Embellecedor ES1960
- Componentes de sujeción
- Cilindro europeo

**ACCESORIOS OPCIONALES**

- Gama completa de cilindros (ver página 128 - 148)

**DESCRIPCIÓN**

**REF.**

**MEDIDAS**

**LEVA**

**ACABADOS**

**UDS**

**B A**

**FRENTE CILINDRO**

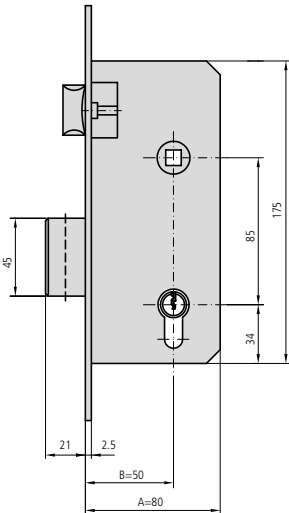
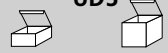

- Cerradura con resbalón y palanca
- Cilindro de leva larga 5982/2525
- Cerradero CE1985/2 o CE1985/6

1985N/40/2	40	68	15	HL	CL	1	12
1985N/40/6	40	68	15	AI	CN	1	12
1985N/50/2	50	78	15	HL	CL	1	12
1985N/50/6	50	78	15	AI	CN	1	12
1985N/60/2	60	88	15	HL	CL	1	12
1985N/60/6	60	88	15	AI	CN	1	12

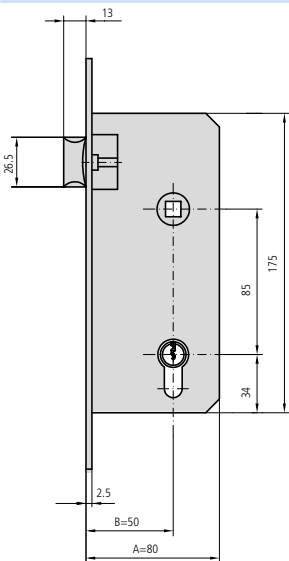

- Cerradura de sólo picaporte
- Con medio cilindro 5982T40
- Cerradero CE1970R/2 o CE1970R/6

1985NT40/2	40	68	15	HL	CL	1	12
1985NT40/6	40	68	15	AI	CN	1	12
1985NT50/2	50	78	15	HL	CL	1	12
1985NT50/6	50	78	15	AI	CN	1	12
1985NT60/2	60	88	15	HL	CL	1	12
1985NT60/6	60	88	15	AI	CN	1	12

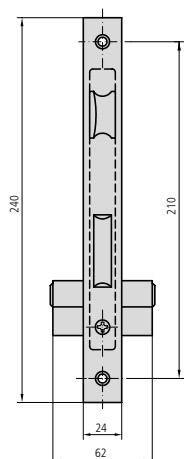
**CARACTERÍSTICAS**

- Entre ejes 70 mm
- Frente de hierro latonado o acero inoxidable
- Picaporte reversible accionable mediante llave y manilla
- Palanca deslizante a dos vueltas de llave
- Cerradero según cerradura
- Embellecedor ES1960
- Componentes de sujeción
- Cilindro europerfil

**ACCESORIOS OPCIONALES**

- Gama completa de cilindros (ver página 128 - 148)

DESCRIPCIÓN	REF.	MEDIDAS		LEVA	ACABADOS		UDS	
		B	A		FRENTE	CILINDRO		
<ul style="list-style-type: none"> <li>• Cerradura con picaporte y palanca</li> <li>• Cilindro de leva larga 5982/2525</li> <li>• Cerradero CE1985/2 o CE1985/6</li> </ul>	1970N/40/2	40	68	15	HL	CL	1	12
	1970N/40/6	40	68	15	AI	CN	1	12
	1970N/50/2	50	78	15	HL	CL	1	12
	1970N/50/6	50	78	15	AI	CN	1	12
	1970N/60/2	60	88	15	HL	CL	1	12
	1970N/60/6	60	88	15	AI	CN	1	12
<ul style="list-style-type: none"> <li>• Cerradura con sólo palanca</li> <li>• Cilindro de leva larga 5982/2525</li> <li>• Cerradero CE1970A/2 o CE1970A/6</li> </ul>	1970NA40/2	40	68	15	HL	CL	1	20
	1970NA40/6	40	68	15	AI	CN	1	20
	1970NA50/2	50	78	15	HL	CL	1	20
	1970NA50/6	50	78	15	AI	CN	1	20
	1970NA60/2	60	88	15	HL	CL	1	20
	1970NA60/6	60	88	15	AI	CN	1	20
<ul style="list-style-type: none"> <li>• Cerradura de sólo picaporte</li> <li>• Con medio cilindro 5982T40</li> <li>• Cerradero CE1970R/2 o CE1970R/6</li> </ul>	1970NT40/2	40	68	15	HL	CL	1	12
	1970NT40/6	40	68	15	AI	CN	1	12
	1970NT50/2	50	78	15	HL	CL	1	12
	1970NT50/6	50	78	15	AI	CN	1	12
	1970NT60/2	60	88	15	HL	CL	1	12
	1970NT60/6	60	88	15	AI	CN	1	12

## CERRADURAS DE PALANCA RECTANGULAR DESLIZANTE

## SERIE 1970N

DESCRIPCIÓN	REF.	MEDIDAS		LEVA	ACABADOS		UDS	UDS
		B	A		FRENTE	CILINDRO		
• Cerradura con rodillo y palanca	1970NV40/6	40	68	15	Al	CN	1	12
• Con cilindro	1970NV50/6	50	78	15	Al	CN	1	12
5982/2525	1970NV60/6	60	88	15	Al	CN	1	12

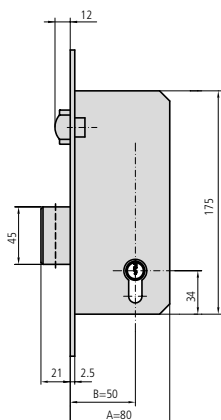

- Cerradura con rodillo y palanca
- Con cilindro 5982/2525
- Cerradero CE1985/2 o CE1985/6



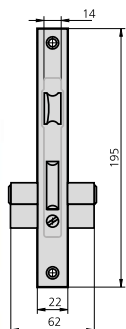

**CARACTERÍSTICAS**

- Entre ejes 48 mm
- Frente de hierro latonado o acero inoxidable
- Picaporte reversible accionable mediante llave y manilla
- Palanca deslizante accionado por una vuelta de llave
- Cerradero según cerradura
- Embellecedor ES1960
- Componentes de sujeción
- Cilindro europerfil

**ACCESORIOS OPCIONALES**

- Gama completa de cilindros (ver página 128 - 148)
- Kit para adaptación condensa (ver página 167)

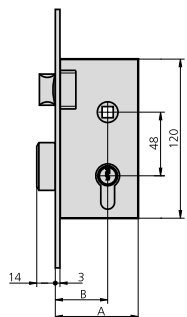
DESCRIPCIÓN	REF.	MEDIDAS		LEVA	ACABADOS		UDS	
		B	A		FRENTE	CILINDRO		



- Cerradura con picaporte y palanca
- Cilindro de leva larga 5982/2525
- Cerradero CE1960/2 o CE1960/6

1960/60/2	40	62	15	HL	CL	1	20
1960/60/6	40	62	15	AI	CN	1	20
1960/70/2	50	72	15	HL	CL	1	20
1960/70/6	50	72	15	AI	CN	1	20

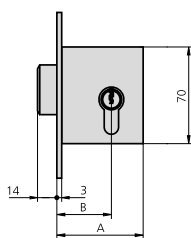

- Cerradura con sólo palanca
- Cilindro de leva larga 5982/2525
- Cerradero CE1960A/2 o CE1960A/6

1960A60/2	40	62	15	HL	CL	1	30
1960A60/6	40	62	15	AI	CN	1	30
1960A70/2	50	72	15	HL	CL	1	30
1960A70/6	50	72	15	AI	CN	1	30

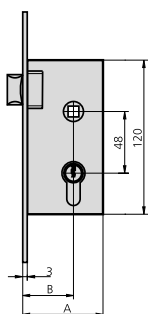

- Cerradura de sólo picaporte
- Con medio cilindro 5982T40
- Cerradero CE249R/2 o CE249R/6

1960T60/2	40	62	15	HL	CL	1	20
1960T60/6	40	62	15	AI	CN	1	20
1960T70/2	50	72	15	HL	CL	1	20
1960T70/6	50	72	15	AI	CN	1	20

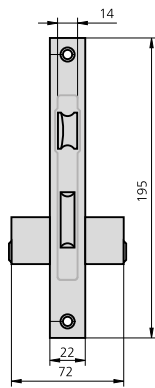

**CARACTERÍSTICAS**

- Frente de hierro latonado
- Picaporte reversible accionable mediante llave y manilla
- Palanca deslizante accionado por llave
- Cerradero según cerradura
- Embellecedor ES1964
- Componentes de sujeción

**ACCESORIOS OPCIONALES**

- Gama completa de cilindros (ver página 128 - 148)

**DESCRIPCIÓN**

**REF.**

**MEDIDAS**

**LEVA**

**ACABADOS**

**UDS**

B A

FRENTE CILINDRO

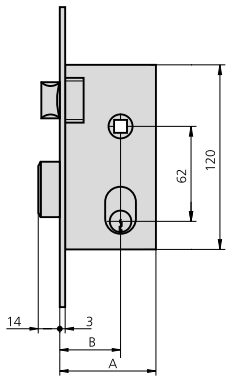
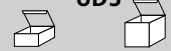

- Cerradura con picaporte y palanca
- Cerradero CE1960/2
- Cilindro ovalado 5961/2525/3

1961/60/2	40	62		HL	CL	1	20
1961/70/2	50	72		HL	CL	1	20

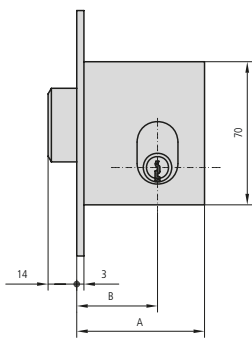

- Cerradura con sólo palanca
- Cerradero CE1960A/2
- Cilindro ovalado 5961/2525/3

1961A60/2	40	62		HL	CL	1	20
1961A70/2	50	72		HL	CL	1	20

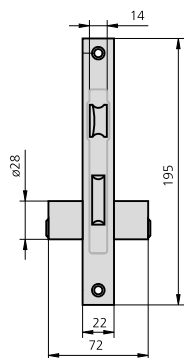

**CARACTERÍSTICAS**

- Frente de hierro latonado
- Picaporte reversible accionable mediante llave y manilla
- Palanca deslizante accionado por llave
- Cerradero según cerradura
- Embellecedor ES1962
- Componentes de sujeción
- Cilindro redondo

**ACCESORIOS OPCIONALES**

- Gama completa de cilindros (ver página 128 - 148)

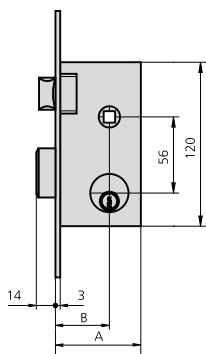
DESCRIPCIÓN	REF.	MEDIDAS		LEVA	ACABADOS		UDS	
		B	A		FRENTE	CILINDRO		



- Cerradura con picaporte y palanca
- Cilindro redondo 5962/2525/3
- Cerradero CE1960/2

1962/60/2	40	62	HL	CL	1	20
1962/70/2	50	72	HL	CL	1	20

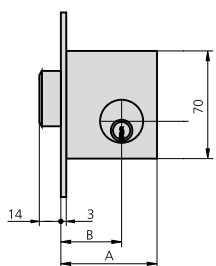

- Cerradura con sólo palanca
- Cilindro redondo 5962/2525/3
- Cerradero CE1960A/2

1962A60/2	40	62	HL	CL	1	30
1962A70/2	50	72	HL	CL	1	30

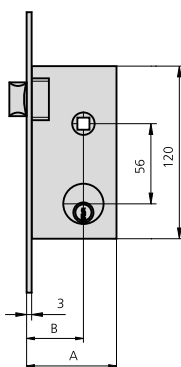

- Cerradura de sólo picaporte
- Medio cilindro redondo 5962T30/3
- Cerradero CE249R/2

1962T60/2	40	62	HL	CL	1	20
1962T70/2	50	72	HL	CL	1	20

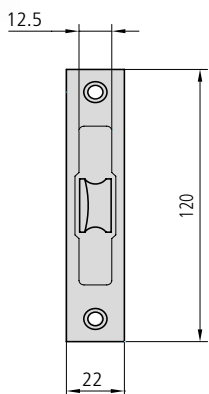

CARACTERÍSTICAS

- Frente de hierro latonado
- Picaporte reversible accionable mediante manilla
- Cerradero según cerradura
- Componentes de sujeción

ACCESORIOS OPCIONALES

DESCRIPCIÓN	REF.	MEDIDAS		LEVA	ACABADOS		UDS	
		B	A		FRENTE	CILINDRO		

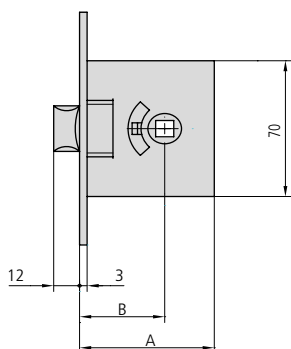

• Cerradura reversible	249B50/2	37	52	HL		1	20
• Picaporte accionable mediante manilla	249B60/2	44	62	HL		1	20
• Cerradero CE249R/2	249B70/2	50	72	HL		1	20

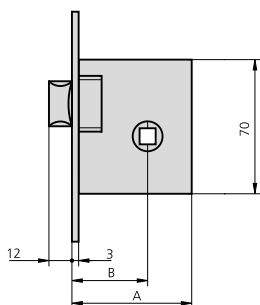

• Picaporte reversible accionable mediante manilla	249R50/2	30	52	HL		1	30
	249R60/2	40	62	HL		1	30
• Cerradero CE249R/2	249R70/2	50	72	HL		1	30

DESCRIPCIÓN	REF.	ACABADO	APLICABLE A CERRADURAS	UDS
-------------	------	---------	------------------------	-----

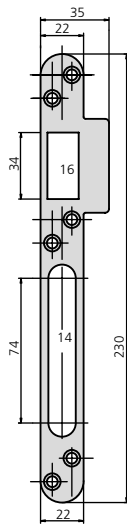

CE4000/2	HL	4000, 4010
CE4000/6	Al	

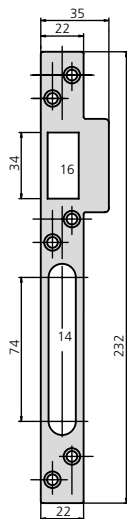

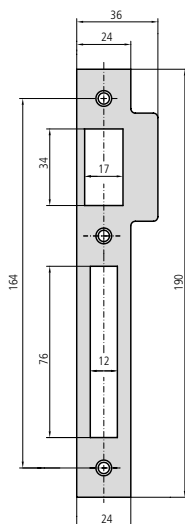

CE4001/2	HL	4001, 4011
CE4001/6	Al	





CE1985/2	HL	1970, 1970C, 1970V
CE1985/6	Al	1985, 1985C, 1985/3P

## ACCESORIOS

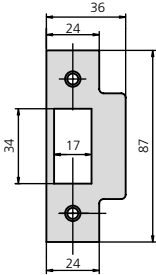
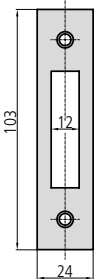
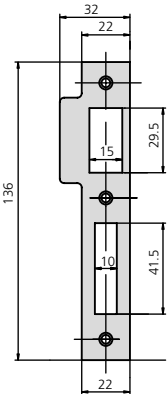
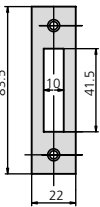
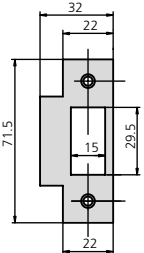
## CERRADEROS

DESCRIPCIÓN	REF.	ACABADO	APLICABLE A CERRADURAS	UDS  
	CE1970R/2 CE1970R/6	HL AI	1970T, 1985T	
	CE1970A/2 CE1970A/6	HL AI	1970A	
	CE1960/2 CE1960/6	HL AI	1960, 1961, 1962, 249C, 63R	
	CE1960A/2 CE1960A/6	HL AI	1960A, 1961A, 1962A	
	CE249R/2 CE249R/6	HL AI	1960T, 1962T, 249B, 249R	

**ACCESORIOS**
**ESCUDOS**

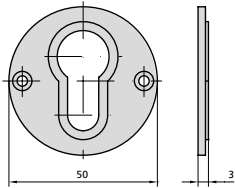
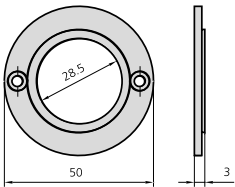
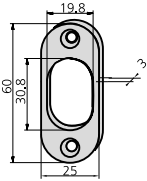
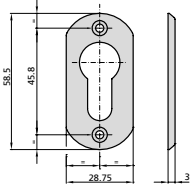
DESCRIPCIÓN	REF.	ACABADO	APLICABLE A CERRADURAS	UDS  
	ES1960 ES1960/4	LP LN	1960, 1970, 1985, 156	
	ES1962 ES1962/4	LP LN	1962, 11981	
	ES1964	Escudo de nylon	1961	
	ES1985/0 ES1985/7	Niquelado Niquelado mate	1985, 1970, 1960	

**ACCESORIOS**
**ESCUDOS DE SEGURIDAD**

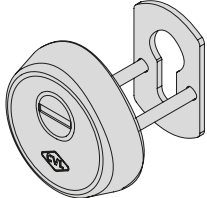
DESCRIPCIÓN	REF.	ACABADO	APLICABLE A CERRADURAS	UDS  
	KES4000		4000, 4001, 4010, 4011, 4100, 4110	
	KES4100		4000, 4001, 4010, 4011, 4100, 4110	





## CILINDROS

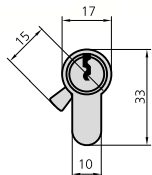

	<b>Cilindro europerfil normal leva larga</b>	<b>128</b>
	• Serie 5982	128
	• Serie 582PM, 5982T, 5982PT	130
	<b>Cilindro europerfil normal leva corta</b>	<b>132</b>
	• Serie 5990	132
	• Serie 590PM, 5990T, 5990PT	134
	<b>Cilindro europerfil de seguridad leva larga</b>	<b>136</b>
	• Serie 6982	136
	• Serie 682PM, 6982T	138
	<b>Cilindro europerfil de seguridad leva corta</b>	<b>139</b>
	• Serie 6990	139
	• Serie 690PM, 6990T	139
	<b>Cilindros ovalados y redondos</b>	<b>142</b>
	• Serie 5963	142
	• Serie 5081	143
• Serie 5961	144	
• Serie 5962	145	
• Serie 5964	146	
• Serie 5968	147	
• Serie 5979	148	







CARACTERÍSTICAS

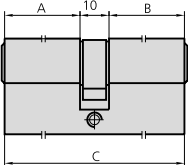

- Cuerpo de latón
- Rotores de latón
- Leva larga de 15 mm
- 5 pitones
- 3 llaves

ACCESORIOS OPCIONALES

DESCRIPCIÓN	REF.	MEDIDAS			ACABADOS	UDS  
		A	B	C		
 <ul style="list-style-type: none"> <li>• Cilindro doble</li> </ul>	5982/2525/3	26	26	62	LP	1
	5982/2525/4	26	26	62	LN	1
	5982/2530/3	26	31	67	LP	1
	5982/2530/4	26	31	67	LN	1
	5982/2535/3	26	36	72	LP	1
	5982/2535/4	26	36	72	LN	1
	5982/3030/3	31	31	72	LP	1
	5982/3030/4	31	31	72	LN	1
	5982/2540/3	26	41	77	LP	1
	5982/2540/4	26	41	77	LN	1
	5982/3035/3	31	36	77	LP	1
	5982/3035/4	31	36	77	LN	1
	5982/2545/3	26	46	82	LP	1
	5982/2545/4	26	46	82	LN	1
	5982/3040/3	31	41	82	LP	1
	5982/3040/4	31	41	82	LN	1
	5982/3535/3	36	36	82	LP	1
	5982/3535/4	36	36	82	LN	1
	5982/2550/3	26	51	87	LP	1
	5982/2550/4	26	51	87	LN	1
	5982/3540/3	36	41	87	LP	1
	5982/3540/4	36	41	87	LN	1
	5982/3045/3	31	46	87	LP	1
	5982/3045/4	31	46	87	LN	1
	5982/2555/3	26	56	92	LP	1
	5982/2555/4	26	56	92	LN	1
	5982/3050/3	31	51	92	LP	1
	5982/3050/4	31	51	92	LN	1
	5982/3545/3	36	46	92	LP	1
	5982/3545/4	36	46	92	LN	1
5982/4040/3	41	41	92	LP	1	
5982/4040/4	41	41	92	LN	1	
5982/2560/3	26	61	97	LP	1	
5982/2560/4	26	61	97	LN	1	
5982/3055/3	31	56	97	LP	1	
5982/3055/4	31	56	97	LN	1	
5982/2565/3	26	66	102	LP	1	
5982/2565/4	26	66	102	LN	1	
5982/3060/3	31	61	102	LP	1	
5982/3060/4	31	61	102	LN	1	
5982/3555/3	36	56	102	LP	1	
5982/3555/4	36	56	102	LN	1	

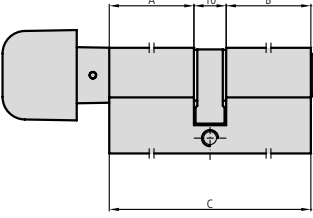
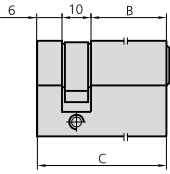
DESCRIPCIÓN	REF.	MEDIDAS			ACABADOS	UDS  
		A	B	C		
5982/4050/3		41	51	102	LP	1
5982/4050/4		41	51	102	LN	1
5982/4545/3		46	46	102	LP	1
5982/4545/4		46	46	102	LN	1
5982/4055/3		41	56	107	LP	1
5982/4055/4		41	56	107	LN	1
5982/2575/3		26	76	112	LP	1
5982/2575/4		26	76	112	LN	1
5982/3565/3		36	66	112	LP	1
5982/3565/4		36	66	112	LN	1
5982/4060/3		41	61	112	LP	1
5982/4060/4		41	61	112	LN	1
5982/4555/3		46	56	112	LP	1
5982/4555/4		46	56	112	LN	1
5982/5050/3		51	51	112	LP	1
5982/5050/4		51	51	112	LN	1
5982/2585/3		26	86	122	LP	1
5982/2585/4		26	86	122	LN	1
5982/3080/3		31	81	122	LP	1
5982/3080/4		31	81	122	LN	1
5982/3575/3		36	76	122	LP	1
5982/3575/4		36	76	122	LN	1
5982/4070/3		41	71	122	LP	1
5982/4070/4		41	71	122	LN	1
5982/5555/3		56	56	122	LP	1
5982/5555/4		56	56	122	LN	1
5982/2595/3		26	96	132	LP	1
5982/2595/4		26	96	132	LN	1
5982/4080/3		41	81	132	LP	1
5982/4080/4		41	81	132	LN	1
5982/6060/3		61	61	132	LP	1
5982/6060/4		61	61	132	LN	1
5982/3595/3		36	96	142	LP	1
5982/3595/4		36	96	142	LN	1
5982/6565/3		66	66	142	LP	1
5982/6565/4		66	66	142	LN	1
5982/7070/3		71	71	152	LP	1
5982/7070/4		71	71	152	LN	1
5982/7575/3		76	76	162	LP	1
5982/7575/4		76	76	162	LN	1

DESCRIPCIÓN	REF.	MEDIDAS			ACABADOS	UDS  
		A	B	C		
 <ul style="list-style-type: none"> <li>• Cilindro con pomo</li> </ul>	582PM2525/3	26	26	62	LP	1
	582PM2525/4	26	26	62	LN	1
	582PM2530/3	26	31	67	LP	1
	582PM2530/4	26	31	67	LN	1
	582PM2535/3	26	36	72	LP	1
	582PM2535/4	26	36	72	LN	1
	582PM3030/3	31	31	72	LP	1
	582PM3030/4	31	31	72	LN	1
	582PM3525/3	36	26	72	LP	1
	582PM3525/4	36	26	72	LN	1
	582PM2540/3	26	41	77	LP	1
	582PM2540/4	26	41	77	LN	1
	582PM2545/3	26	46	82	LP	1
	582PM2545/4	26	46	82	LN	1
	582PM3535/3	36	36	82	LP	1
	582PM3535/4	36	36	82	LN	1
	582PM2550/3	26	51	87	LP	1
	582PM2550/4	26	51	87	LN	1
	582PM3045/3	31	46	87	LP	1
	582PM3045/4	31	46	87	LN	1
	582PM3540/3	36	41	87	LP	1
	582PM3540/4	36	41	87	LN	1
	582PM2555/3	26	56	92	LP	1
	582PM2555/4	26	56	92	LN	1
	582PM3545/3	36	46	92	LP	1
	582PM3545/4	36	46	92	LN	1
	582PM2560/3	26	61	97	LP	1
	582PM2560/4	26	61	97	LN	1
	582PM2565/3	26	66	102	LP	1
	582PM2565/4	26	66	102	LN	1
	 <ul style="list-style-type: none"> <li>• Medio cilindro</li> </ul>	5982T40/3	26	42	LP	1
		5982T40/4	26	42	LN	1
		5982T45/3	31	47	LP	1
5982T45/4		31	47	LN	1	
5982T50/3		36	52	LP	1	
5982T50/4		36	52	LN	1	
5982T55/3		41	57	LP	1	
5982T55/4		41	57	LN	1	
5982T60/3		46	62	LP	1	
5982T60/4		46	62	LN	1	
5982T65/3		51	67	LP	1	
5982T65/4	51	67	LN	1		
5982T70/3	56	72	LP	1		
5982T70/4	56	72	LN	1		

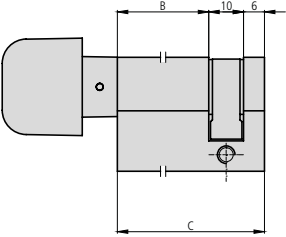
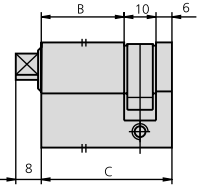
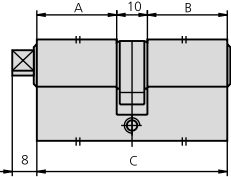
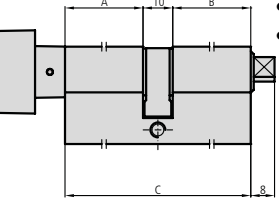
DESCRIPCIÓN	REF.	MEDIDAS			ACABADOS	UDS  
		A	B	C		
<ul style="list-style-type: none"> <li>Medio cilindro con pomo</li> </ul> 	582PM2505/3		26	42	LP	1
	582PM2505/4		26	42	LN	1
	582PM3005/3		31	47	LP	1
	582PM3005/4		31	47	LN	1
	582PM3505/3		36	52	LP	1
	582PM3505/4		36	52	LN	1
	582PM4005/3		41	57	LP	1
	582PM4005/4		41	57	LN	1
	582PM4505/3		46	62	LP	1
	582PM4505/4		46	62	LN	1
	582PM5005/3		51	67	LP	1
	582PM5005/4		51	67	LN	1
	582PM5505/3		56	72	LP	1
	582PM5505/4		56	72	LN	1
 <ul style="list-style-type: none"> <li>Medio cilindro</li> <li>Triángulo por un lado</li> </ul>	5982PT2505/3		26	42	LP	1
	5982PT2505/4		26	42	LN	1
 <ul style="list-style-type: none"> <li>Doble cilindro</li> <li>Llave por un lado y triángulo por el otro</li> </ul>	5982PT2525/3	26	26	62	LP	1
	5982PT2525/4	26	26	62	LN	1
	5982PT2535/3	26	36	72	LP	1
	5982PT2535/4	26	36	72	LN	1
	5982PT2545/3	26	46	82	LP	1
	5982PT2545/4	26	46	82	LN	1
 <ul style="list-style-type: none"> <li>Doble cilindro</li> <li>Triángulo por un lado y pomo por el otro</li> </ul>	582PM25T25/3	26	26	62	LP	1
	582PM25T25/4	26	26	62	LN	1
	582PM30T30/3	31	31	72	LP	1
	582PM30T30/4	31	31	72	LN	1
	582PM35T25/3	36	26	72	LP	1
	582PM35T25/4	36	26	72	LN	1
	582PM35T35/3	36	36	82	LP	1
	582PM35T35/4	36	36	82	LN	1
	582PM30T45/3	31	46	87	LP	1
	582PM30T45/4	31	46	87	LN	1

CARACTERÍSTICAS

- Cuerpo de latón
- Rotores de latón
- Leva corta de 13,25 mm
- 5 pitones
- 3 llaves

ACCESORIOS OPCIONALES

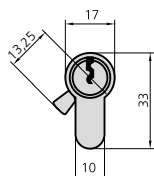

DESCRIPCIÓN

REF.

MEDIDAS

ACABADOS

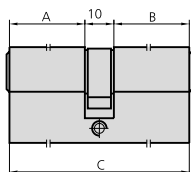

UDS

A B C



- Cilindro doble

5990/2525/3	26	26	62	LP	1
5990/2525/4	26	26	62	LN	1
5990/2530/3	26	31	67	LP	1
5990/2530/4	26	31	67	LN	1
5990/2535/3	26	36	72	LP	1
5990/2535/4	26	36	72	LN	1
5990/3030/3	31	31	72	LP	1
5990/3030/4	31	31	72	LN	1
5990/2540/3	26	41	77	LP	1
5990/2540/4	26	41	77	LN	1
5990/3035/3	31	36	77	LP	1
5990/3035/4	31	36	77	LN	1
5990/2545/3	26	46	82	LP	1
5990/2545/4	26	46	82	LN	1
5990/3040/3	31	41	82	LP	1
5990/3040/4	31	41	82	LN	1
5990/3535/3	36	36	82	LP	1
5990/3535/4	36	36	82	LN	1
5990/2550/3	26	51	87	LP	1
5990/2550/4	26	51	87	LN	1
5990/3540/3	36	41	87	LP	1
5990/3540/4	36	41	87	LN	1
5990/3045/3	31	46	87	LP	1
5990/3045/4	31	46	87	LN	1
5990/2555/3	26	56	92	LP	1
5990/2555/4	26	56	92	LN	1
5990/3050/3	31	51	92	LP	1
5990/3050/4	31	51	92	LN	1
5990/3545/3	36	46	92	LP	1
5990/3545/4	36	46	92	LN	1
5990/4040/3	41	41	92	LP	1
5990/4040/4	41	41	92	LN	1
5990/2560/3	26	61	97	LP	1
5990/2560/4	26	61	97	LN	1
5990/3055/3	31	56	97	LP	1
5990/3055/4	31	56	97	LN	1
5990/2565/3	26	66	102	LP	1
5990/2565/4	26	66	102	LN	1

DESCRIPCIÓN	REF.	MEDIDAS			ACABADOS	UDS  
		A	B	C		
	5990/3060/3	31	61	102	LP	1
	5990/3060/4	31	61	102	LN	1
	5990/3555/3	36	56	102	LP	1
	5990/3555/4	36	56	102	LN	1
	5990/4050/3	41	51	102	LP	1
	5990/4050/4	41	51	102	LN	1
	5990/4545/3	46	46	102	LP	1
	5990/4545/4	46	46	102	LN	1
	5990/4055/3	41	56	107	LP	1
	5990/4055/4	41	56	107	LN	1
	5990/2575/3	26	76	112	LP	1
	5990/2575/4	26	76	112	LN	1
	5990/3565/3	36	66	112	LP	1
	5990/3565/4	36	66	112	LN	1
	5990/4060/3	41	61	112	LP	1
	5990/4060/4	41	61	112	LN	1
	5990/4555/3	46	56	112	LP	1
	5990/4555/4	46	56	112	LN	1
	5990/5050/3	51	51	112	LP	1
	5990/5050/4	51	51	112	LN	1
	5990/2585/3	26	86	122	LP	1
	5990/2585/4	26	86	122	LN	1
	5990/3080/3	31	81	122	LP	1
	5990/3080/4	31	81	122	LN	1
	5990/3575/3	36	76	122	LP	1
	5990/3575/4	36	76	122	LN	1
	5990/4070/3	41	71	122	LP	1
	5990/4070/4	41	71	122	LN	1
	5990/5555/3	56	56	122	LP	1
	5990/5555/4	56	56	122	LN	1
	5990/2595/3	26	96	132	LP	1
	5990/2595/4	26	96	132	LN	1
	5990/4080/3	41	81	132	LP	1
	5990/4080/4	41	81	132	LN	1
	5990/6060/3	61	61	132	LP	1
	5990/6060/4	61	61	132	LN	1
	5990/3595/3	36	96	142	LP	1
	5990/3595/4	36	96	142	LN	1
	5990/6565/3	66	66	142	LP	1
	5990/6565/4	66	66	142	LN	1
	5990/7070/3	71	71	152	LP	1
	5990/7070/4	71	71	152	LN	1
	5990/7575/3	76	76	162	LP	1
	5990/7575/4	76	76	162	LN	1

DESCRIPCIÓN

REF.

MEDIDAS

ACABADOS

UDS

A B C



- Cilindro con pomo

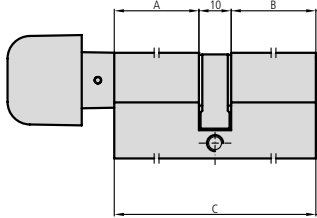

590PM2525/3	26	26	62	LP	1
590PM2525/4	26	26	62	LN	1
590PM2530/3	26	31	67	LP	1
590PM2530/4	26	31	67	LN	1
590PM2535/3	26	36	72	LP	1
590PM2535/4	26	36	72	LN	1
590PM3030/3	31	31	72	LP	1
590PM3030/4	31	31	72	LN	1
590PM3525/3	36	26	72	LP	1
590PM3525/4	36	26	72	LN	1
590PM2540/3	26	41	77	LP	1
590PM2540/4	26	41	77	LN	1
590PM2545/3	26	46	82	LP	1
590PM2545/4	26	46	82	LN	1
590PM3535/3	36	36	82	LP	1
590PM3535/4	36	36	82	LN	1
590PM2550/3	26	51	87	LP	1
590PM2550/4	26	51	87	LN	1
590PM3045/3	31	46	87	LP	1
590PM3045/4	31	46	87	LN	1
590PM3540/3	36	41	87	LP	1
590PM3540/4	36	41	87	LN	1
590PM2555/3	26	56	92	LP	1
590PM2555/4	26	56	92	LN	1
590PM3545/3	36	46	92	LP	1
590PM3545/4	36	46	92	LN	1
590PM2560/3	26	61	97	LP	1
590PM2560/4	26	61	97	LN	1
590PM2565/3	26	66	102	LP	1
590PM2565/4	26	66	102	LN	1

- Medio cilindro

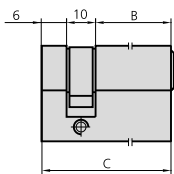

5990T40/3	26	42	LP	1
5990T40/4	26	42	LN	1
5990T45/3	31	47	LP	1
5990T45/4	31	47	LN	1
5990T50/3	36	52	LP	1
5990T50/4	36	52	LN	1
5990T55/3	41	57	LP	1
5990T55/4	41	57	LN	1
5990T60/3	46	62	LP	1
5990T60/4	46	62	LN	1
5990T65/3	51	67	LP	1
5990T65/4	51	67	LN	1
5990T70/3	56	72	LP	1
5990T70/4	56	72	LN	1

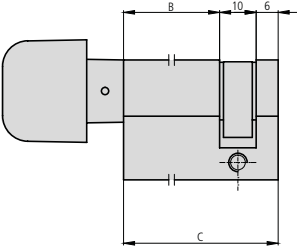
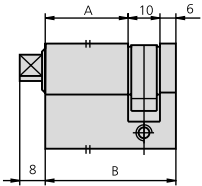
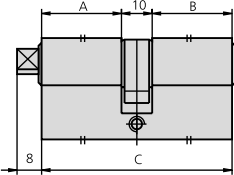
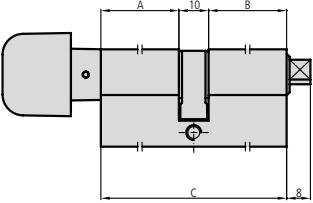

**CILINDRO EUROPERFIL NORMAL LEVA CORTA**
**SERIE 590PM, 5990PT**

DESCRIPCIÓN	REF.	MEDIDAS			ACABADOS	UDS
		A	B	C		
 <ul style="list-style-type: none"> <li>Medio cilindro con pomo</li> </ul>	590PM2505/3	26	42	LP	1	
	590PM2505/4	26	42	LN	1	
	590PM3005/3	31	47	LP	1	
	590PM3005/4	31	47	LN	1	
	590PM3505/3	36	52	LP	1	
	590PM3505/4	36	52	LN	1	
	590PM4005/3	41	57	LP	1	
	590PM4005/4	41	57	LN	1	
	590PM4505/3	46	62	LP	1	
	590PM4505/4	46	62	LN	1	
	590PM5005/3	51	67	LP	1	
	590PM5005/4	51	67	LN	1	
	590PM5505/3	56	72	LP	1	
	590PM5505/4	56	72	LN	1	
 <ul style="list-style-type: none"> <li>Medio cilindro</li> <li>Triángulo por un lado</li> </ul>	5990PT2505/3	26	42	LP	1	
	5990PT2505/4	26	42	LN	1	
 <ul style="list-style-type: none"> <li>Doble cilindro</li> <li>Llave por un lado y triángulo por el otro</li> </ul>	5990PT2525/3	26	26	62	LP	1
	5990PT2525/4	26	26	62	LN	1
	5990PT2535/3	26	36	72	LP	1
	5990PT2535/4	26	36	72	LN	1
	5990PT2545/3	26	46	82	LP	1
	5990PT2545/4	26	46	82	LN	1
 <ul style="list-style-type: none"> <li>Doble cilindro</li> <li>Triángulo por un lado y pomo por el otro</li> </ul>	590PM25T25/3	26	26	62	LP	1
	590PM25T25/4	26	26	62	LN	1
	590PM30T30/3	31	31	72	LP	1
	590PM30T30/4	31	31	72	LN	1
	590PM35T25/3	36	26	72	LP	1
	590PM35T25/4	36	26	72	LN	1
	590PM35T35/3	36	36	82	LP	1
	590PM35T35/4	36	36	82	LN	1
	590PM30T45/3	31	46	87	LP	1
	590PM30T45/4	31	46	87	LN	1

CARACTERÍSTICAS

- Cuerpo de latón
- Rotores de latón
- Leva larga de 15 mm
- Pasadores antitaladro
- 5 pitones de inoxidable
- 5 llaves

ACCESORIOS OPCIONALES

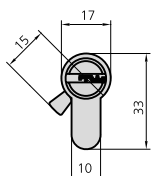

DESCRIPCIÓN

REF.

MEDIDAS

ACABADOS

UDS

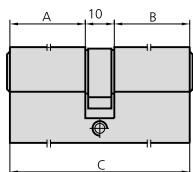

A B C



- Cilindro doble

6982/2525/3	26	26	62	LP	1
6982/2525/4	26	26	62	LN	1
6982/2530/3	26	31	67	LP	1
6982/2530/4	26	31	67	LN	1
6982/2535/3	26	36	72	LP	1
6982/2535/4	26	36	72	LN	1
6982/3030/3	31	31	72	LP	1
6982/3030/4	31	31	72	LN	1
6982/2540/3	26	41	77	LP	1
6982/2540/4	26	41	77	LN	1
6982/3035/3	31	36	77	LP	1
6982/3035/4	31	36	77	LN	1
6982/2545/3	26	46	82	LP	1
6982/2545/4	26	46	82	LN	1
6982/3040/3	31	41	82	LP	1
6982/3040/4	31	41	82	LN	1
6982/3535/3	36	36	82	LP	1
6982/3535/4	36	36	82	LN	1
6982/2550/3	26	51	87	LP	1
6982/2550/4	26	51	87	LN	1
6982/3540/3	36	41	87	LP	1
6982/3540/4	36	41	87	LN	1
6982/3045/3	31	46	87	LP	1
6982/3045/4	31	46	87	LN	1
6982/2555/3	26	56	92	LP	1
6982/2555/4	26	56	92	LN	1
6982/3050/3	31	51	92	LP	1
6982/3050/4	31	51	92	LN	1
6982/3545/3	36	46	92	LP	1
6982/3545/4	36	46	92	LN	1
6982/4040/3	41	41	92	LP	1
6982/4040/4	41	41	92	LN	1
6982/2560/3	26	61	97	LP	1
6982/2560/4	26	61	97	LN	1
6982/3055/3	31	56	97	LP	1
6982/3055/4	31	56	97	LN	1
6982/4045/3	41	46	97	LP	1
6982/4045/4	41	46	97	LN	1

DESCRIPCIÓN	REF.	MEDIDAS			ACABADOS	UDS 
		A	B	C		
	6982/2565/3	26	66	102	LP	1
	6982/2565/4	26	66	102	LN	1
	6982/3060/3	31	61	102	LP	1
	6982/3060/4	31	61	102	LN	1
	6982/3555/3	36	56	102	LP	1
	6982/3555/4	36	56	102	LN	1
	6982/4050/3	41	51	102	LP	1
	6982/4050/4	41	51	102	LN	1
	6982/4545/3	46	46	102	LP	1
	6982/4545/4	46	46	102	LN	1
	6982/4055/3	41	56	107	LP	1
	6982/4055/4	41	56	107	LN	1
	6982/2575/3	26	76	112	LP	1
	6982/2575/4	26	76	112	LN	1
	6982/3565/3	36	66	112	LP	1
	6982/3565/4	36	66	112	LN	1
	6982/4555/3	46	56	112	LP	1
	6982/4555/4	46	56	112	LN	1
	6982/5050/3	51	51	112	LP	1
	6982/5050/4	51	51	112	LN	1
	6982/4560/3	46	61	117	LP	1
	6982/4560/4	46	61	117	LN	1
	6982/2585/3	26	86	122	LP	1
	6982/2585/4	26	86	122	LN	1
	6982/5555/3	56	56	122	LP	1
	6982/5555/4	56	56	122	LN	1
	6982/2595/3	26	96	132	LP	1
	6982/2595/4	26	96	132	LN	1
	6982/6565/3	66	66	142	LP	1
	6982/6565/4	66	66	142	LN	1
	6982/7070/3	71	71	152	LP	1
	6982/7070/4	71	71	152	LN	1
	6982/7575/3	76	76	162	LP	1
	6982/7575/4	76	76	162	LN	1

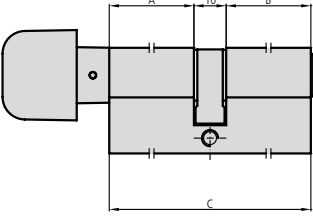

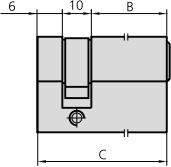
DESCRIPCIÓN	REF.	MEDIDAS			ACABADOS	UDS  
		A	B	C		
 <ul style="list-style-type: none"> <li>• Cilindro con pomo</li> </ul>	682PM2525/3	26	26	62	LP	1
	682PM2525/4	26	26	62	LN	1
	682PM2535/3	26	36	72	LP	1
	682PM2535/4	26	36	72	LN	1
	682PM3525/3	36	26	72	LP	1
	682PM3525/4	36	26	72	LN	1
	682PM3030/3	31	31	72	LP	1
	682PM3030/4	31	31	72	LN	1
	682PM2545/3	26	46	82	LP	1
	682PM2545/4	26	46	82	LN	1
	682PM3535/3	36	36	82	LP	1
	682PM3535/4	36	36	82	LN	1
	682PM2555/3	26	56	92	LP	1
	682PM2555/4	26	56	92	LN	1
	682PM3545/3	36	46	92	LP	1
	682PM3545/4	36	46	92	LN	1
	682PM3555/3	36	56	102	LP	1
	682PM3555/4	36	56	102	LN	1
	682PM3565/3	36	66	112	LP	1
	682PM3565/4	36	66	112	LN	1



 <ul style="list-style-type: none"> <li>• Medio cilindro</li> </ul>	6982T40/3	26	42	LP	1
	6982T40/4	26	42	LN	1
	6982T50/3	36	52	LP	1
	6982T50/4	36	52	LN	1
	6982T60/3	46	62	LP	1
	6982T60/4	46	62	LN	1
	6982T70/3	56	72	LP	1
	6982T70/4	56	72	LN	1

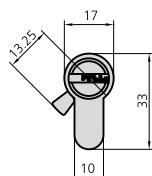

**CARACTERÍSTICAS**

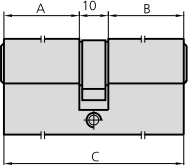
- Cuerpo de latón
- Rotores de latón
- Leva corta de 13,25 mm
- Pasadores antitaladro
- 5 pitones de inoxidable
- 5 llaves

**ACCESORIOS OPCIONALES**

DESCRIPCIÓN	REF.	MEDIDAS			ACABADOS	UDS  
		A	B	C		
 <ul style="list-style-type: none"> <li>• Cilindro doble</li> </ul>	6990/2525/3	26	26	62	LP	1
	6990/2525/4	26	26	62	LN	1
	6990/2530/3	26	31	67	LP	1
	6990/2530/4	26	31	67	LN	1
	6990/2535/3	26	36	72	LP	1
	6990/2535/4	26	36	72	LN	1
	6990/3030/3	31	31	72	LP	1
	6990/3030/4	31	31	72	LN	1
	6990/2540/3	26	41	77	LP	1
	6990/2540/4	26	41	77	LN	1
	6990/3035/3	31	36	77	LP	1
	6990/3035/4	31	36	77	LN	1
	6990/2545/3	26	46	82	LP	1
	6990/2545/4	26	46	82	LN	1
	6990/3040/3	31	41	82	LP	1
	6990/3040/4	31	41	82	LN	1
	6990/3535/3	36	36	82	LP	1
	6990/3535/4	36	36	82	LN	1
	6990/2550/3	26	51	87	LP	1
	6990/2550/4	26	51	87	LN	1
6990/3540/3	36	41	87	LP	1	
6990/3540/4	36	41	87	LN	1	
6990/3045/3	31	46	87	LP	1	
6990/3045/4	31	46	87	LN	1	
6990/2555/3	26	56	92	LP	1	
6990/2555/4	26	56	92	LN	1	
6990/3050/3	31	51	92	LP	1	
6990/3050/4	31	51	92	LN	1	
6990/3545/3	36	46	92	LP	1	
6990/3545/4	36	46	92	LN	1	
6990/4040/3	41	41	92	LP	1	
6990/4040/4	41	41	92	LN	1	
6990/2560/3	26	61	97	LP	1	
6990/2560/4	26	61	97	LN	1	
6990/3055/3	31	56	97	LP	1	
6990/3055/4	31	56	97	LN	1	
6990/4045/3	41	46	97	LP	1	
6990/4045/4	41	46	97	LN	1	

DESCRIPCIÓN	REF.	MEDIDAS			ACABADOS	UDS  
		A	B	C		
	6990/2565/3	26	66	102	LP	1
	6990/2565/4	26	66	102	LN	1
	6990/3060/3	31	61	102	LP	1
	6990/3060/4	31	61	102	LN	1
	6990/3555/3	36	56	102	LP	1
	6990/3555/4	36	56	102	LN	1
	6990/4050/3	41	51	102	LP	1
	6990/4050/4	41	51	102	LN	1
	6990/4545/3	46	46	102	LP	1
	6990/4545/4	46	46	102	LN	1
	6990/4055/3	41	56	107	LP	1
	6990/4055/4	41	56	107	LN	1
	6990/2575/3	26	76	112	LP	1
	6990/2575/4	26	76	112	LN	1
	6990/3565/3	36	66	112	LP	1
	6990/3565/4	36	66	112	LN	1
	6990/4555/3	46	56	112	LP	1
	6990/4555/4	46	56	112	LN	1
	6990/5050/3	51	51	112	LP	1
	6990/5050/4	51	51	112	LN	1
	6990/4560/3	46	61	117	LP	1
	6990/4560/4	46	61	117	LN	1
	6990/2585/3	26	86	122	LP	1
	6990/2585/4	26	86	122	LN	1
	6990/5555/3	56	56	122	LP	1
	6990/5555/4	56	56	122	LN	1
	6990/2595/3	26	96	132	LP	1
	6990/2595/4	26	96	132	LN	1
	6990/6565/3	66	66	142	LP	1
	6990/6565/4	66	66	142	LN	1
	6990/7070/3	71	71	152	LP	1
	6990/7070/4	71	71	152	LN	1
	6990/7575/3	76	76	162	LP	1
	6990/7575/4	76	76	162	LN	1

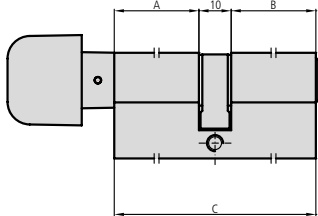
DESCRIPCIÓN	REF.	MEDIDAS			ACABADOS	UDS  
		A	B	C		
<ul style="list-style-type: none"> <li>• Cilindro con pomo</li> </ul> 	690PM2525/3	26	26	62	LP	1
	690PM2525/4	26	26	62	LN	1
	690PM2535/3	26	36	72	LP	1
	690PM2535/4	26	36	72	LN	1
	690PM3525/3	36	26	72	LP	1
	690PM3525/4	36	26	72	LN	1
	690PM3030/3	31	31	72	LP	1
	690PM3030/4	31	31	72	LN	1
	690PM2545/3	26	46	82	LP	1
	690PM2545/4	26	46	82	LN	1
	690PM3535/3	36	36	82	LP	1
	690PM3535/4	36	36	82	LN	1
	690PM2555/3	26	56	92	LP	1
	690PM2555/4	26	56	92	LN	1
	690PM3545/3	36	46	92	LP	1
	690PM3545/4	36	46	92	LN	1
	690PM3555/3	36	56	102	LP	1
	690PM3555/4	36	56	102	LN	1
	690PM3565/3	36	66	112	LP	1
	690PM3565/4	36	66	112	LN	1

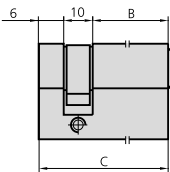

<ul style="list-style-type: none"> <li>• Medio cilindro</li> </ul> 	6990T40/3	26	42	LP	1
	6990T40/4	26	42	LN	1
	6990T50/3	36	52	LP	1
	6990T50/4	36	52	LN	1
	6990T60/3	46	62	LP	1
	6990T60/4	46	62	LN	1
	6990T70/3	56	72	LP	1
	6990T70/4	56	72	LN	1

CARACTERÍSTICAS

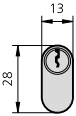
- Cilindro ovalado pequeño
- Cuerpo de latón
- Rotores de latón
- Dos levas
- 3 llaves

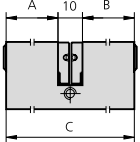
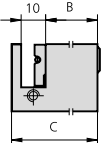

ACCESORIOS OPCIONALES

DESCRIPCIÓN	REF.	MEDIDAS			ACABADOS	APLICABLE A CERRADURAS	UDS	
		A	B	C				
 <ul style="list-style-type: none"> <li>• Cilindro doble</li> </ul>	5963/2222/3	22	22	54	LP		1	
	5963/2222/4	22	22	54	LN		1	
	5963/2525/3	26	26	62	LP		1	
	5963/2525/4	26	26	62	LN		1	
	5963/3030/3	31	31	72	LP	1963	1	
	5963/3030/4	31	31	72	LN	1975	1	
	5963/3535/3	36	36	82	LP		1	
	5963/3535/4	36	36	82	LN		1	
	5963/4040/3	41	41	92	LP		1	
	5963/4040/4	41	41	92	LN		1	
 <ul style="list-style-type: none"> <li>• Medio cilindro</li> </ul>	5963T36/3		22	36	LP	1963	1	
	5963T36/4		22	36	LN	1975	1	



**CARACTERÍSTICAS**

- Cuerpo de latón
- Rotores de latón
- Con levas y vástagos
- 3 llaves

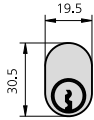
**ACCESORIOS OPCIONALES**

DESCRIPCIÓN	REF.	MEDIDAS			ACABADOS	APLICABLE A CERRADURAS	UDS	
		A	B	C				
<ul style="list-style-type: none"> <li>• Cilindro doble</li> <li>• Ovalado</li> </ul>	5081/3030/3	26,5	26,5	74	LP		1	
	5081/3030/4	26,5	26,5	74	LN	1981	1	
<ul style="list-style-type: none"> <li>• Cilindro doble</li> <li>• Redondo</li> </ul>	5181/3030/3	26,5	26,5	74	LP		1	
	5181/3030/4	26,5	26,5	74	LN	11981	1	





CARACTERÍSTICAS

- Cuerpo de latón
- Rotores de latón
- Con levas y vástagos
- 3 llaves

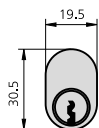
ACCESORIOS OPCIONALES

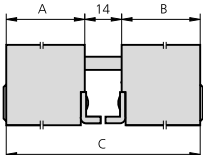

DESCRIPCIÓN	REF.	MEDIDAS			ACABADOS	APLICABLE A CERRADURAS	UDS	
		A	B	C				
 <ul style="list-style-type: none"> <li>• Cilindro doble</li> <li>• Ovalado</li> </ul>	5961/2525/3	25	25	64	LP	1961		1
	5961/2525/4	25	25	64	LN			1
	5961/3030/3	30	30	74	LP			1
	5961/3030/4	30	30	74	LN			1

**CARACTERÍSTICAS**

- Cuerpo de latón
- Rotores de latón
- Con levas y vástagos
- 3 llaves

**ACCESORIOS OPCIONALES**

DESCRIPCIÓN	REF.	MEDIDAS			ACABADOS	APLICABLE A CERRADURAS	UDS	
		A	B	C				
<ul style="list-style-type: none"> <li>• Cilindro doble</li> <li>• Redondo</li> </ul>	5962/2525/3	25	25	64	LP		1	
	5962/3030/3	30	30	74	LN	1962	1	
	5962/4040/3	40	40	94	LP		1	
<ul style="list-style-type: none"> <li>• Medio cilindro</li> <li>• Redondo</li> </ul>	5962T30/3			30	LP		1	
	5962T40/3			40	LN	1962	1	

CARACTERÍSTICAS

ACCESORIOS OPCIONALES



- Cilindro ovalado
- Cuerpo de latón
- Rotores de latón
- Con levas y vástagos

- 3 llaves

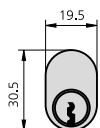

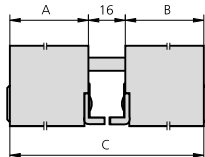
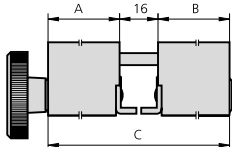
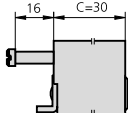
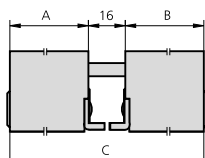
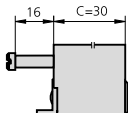
DESCRIPCIÓN	REF.	MEDIDAS			ACABADOS	APLICABLE A CERRADURAS	UDS	
		A	B	C				
 <ul style="list-style-type: none"> <li>• Cilindro doble</li> <li>• Llave normal</li> </ul>	5964/2525/3	25	25	66	LP	1964		1
	5964/2525/4	25	25	66	LN			1
	5964/3030/3	30	30	76	LP			1
	5964/3030/4	30	30	76	LN			1
	5964/4040/3	40	40	96	LP			1
	5964/4040/4	40	40	96	LN			1
 <ul style="list-style-type: none"> <li>• Cilindro doble con pomo</li> <li>• Llave normal</li> </ul>	5964P3030/3	30	30	76	LP	1964		1
	5964P3030/4	30	30	76	LN			1
 <ul style="list-style-type: none"> <li>• Medio cilindro</li> <li>• Llave normal</li> </ul>	5964T25/3			25	LP	1964		1
	5964T25/4			25	LN			1
	5964T30/3			30	LP			1
	5964T30/4			30	LN			1
	5964T40/3			40	LP			1
	5964T40/4			40	LN			1
 <ul style="list-style-type: none"> <li>• Cilindro doble</li> <li>• Llave de seguridad</li> </ul>	6964/3030/3	30	30	76	LP	1964		1
	6964/3030/4	30	30	76	LN			1
 <ul style="list-style-type: none"> <li>• Medio cilindro</li> <li>• Llave de seguridad</li> </ul>	6964T30/3			30	LP	1964		1
	6964T30/4			30	LN			1

CILINDROS

**CARACTERÍSTICAS**

- Cilindro ovalado
- Cuerpo de latón
- Rotores de latón
- Con levas y vástagos
- 3 llaves

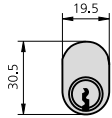
**ACCESORIOS OPCIONALES**

DESCRIPCIÓN	REF.	MEDIDAS			ACABADOS	APLICABLE A CERRADURAS	UDS	
		A	B	C				
<ul style="list-style-type: none"> <li>• Cilindro doble</li> <li>• Llave normal</li> </ul>	5968/2525/3	25	25	66	LP	1968		1
	5968/2525/4	25	25	66	LN			1
	5968/3030/3	30	30	76	LP			1
	5968/3030/4	30	30	76	LN			1
	5968/4040/3	40	40	96	LP			1
	5968/4040/4	40	40	96	LN			1
<ul style="list-style-type: none"> <li>• Cilindro doble con pomo</li> <li>• Llave normal</li> </ul>	5968P3030/3	30	30	76	LP	1968		1
	5968P3030/4	30	30	76	LN			1
<ul style="list-style-type: none"> <li>• Medio cilindro</li> <li>• Llave normal</li> </ul>	5968T25/3			25	LP	1968		1
	5968T25/4			25	LN			1
	5968T30/3			30	LP			1
	5968T30/4			30	LN			1
	5968T40/3			40	LP			1
	5968T40/4			40	LN			1
<ul style="list-style-type: none"> <li>• Cilindro doble</li> <li>• Llave de seguridad</li> </ul>	6968/3030/3	30	30	76	LP	1968		1
	6968/3030/4	30	30	76	LN			1
<ul style="list-style-type: none"> <li>• Medio cilindro</li> <li>• Llave de seguridad</li> </ul>	6968T30/3			30	LP	1968		1
	6968T30/4			30	LN			1

CARACTERÍSTICAS

ACCESORIOS OPCIONALES



- Cilindro ovalado
- Cuerpo de latón
- Rotores de latón
- Con levas y vástagos

- 3 llaves

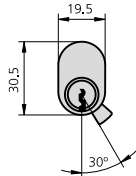

DESCRIPCIÓN	REF.	MEDIDAS			ACABADOS	APLICABLE A CERRADURAS	UDS	
		A	B	C				
<ul style="list-style-type: none"> <li>• Cilindro doble</li> </ul>	5979/3030/3	30	30	76	LP	1979	1	
	5979/3030/4	30	30	76	LN		1	
<ul style="list-style-type: none"> <li>• Cilindro doble con pomo</li> </ul>	5979P3030/3	30	30	76	LP	1979P	1	
	5979P3030/4	30	30	76	LN		1	

## VÍAS DE ESCAPE Y CORTAFUEGO

Barra Antipánico de Cierre Lateral con Marcado CE	151
• Serie 5000	151
Barra Antipánico acoplable a cerradura de embutir con Marcado CE	152
• Serie 5500	152
Barra Antipánico de cierre alto-bajo con Marcado CE	153
• Serie 6000	153
 Cerradura antipánico palanca deslizante	154
• Series 615, 612 <b>alu</b> panic	154
• Series 615E, 612E <b>alu</b> panic	155
Cerraduras de embutir	156
• Serie 400	156
• Serie 400T	157
Cerradura antipánico para vías de escape con marcado CE	158
• Serie 410	158
Accesorios	161
• Escudos y Manillas de Acero Inoxidable	161
• Escudos y Manillas en negro	162
• Cilindros y otros accesorios	163

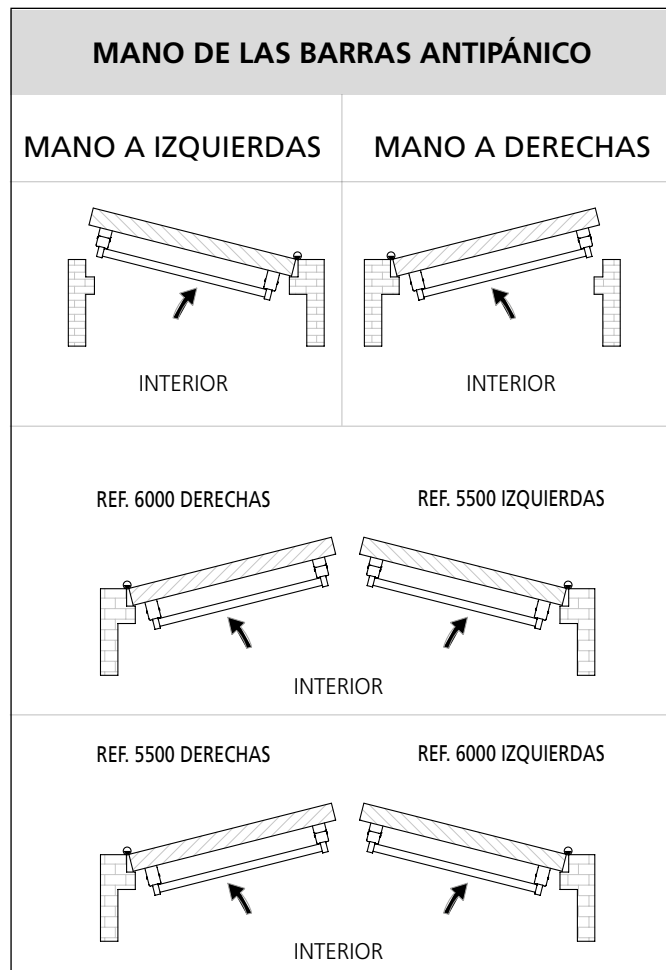
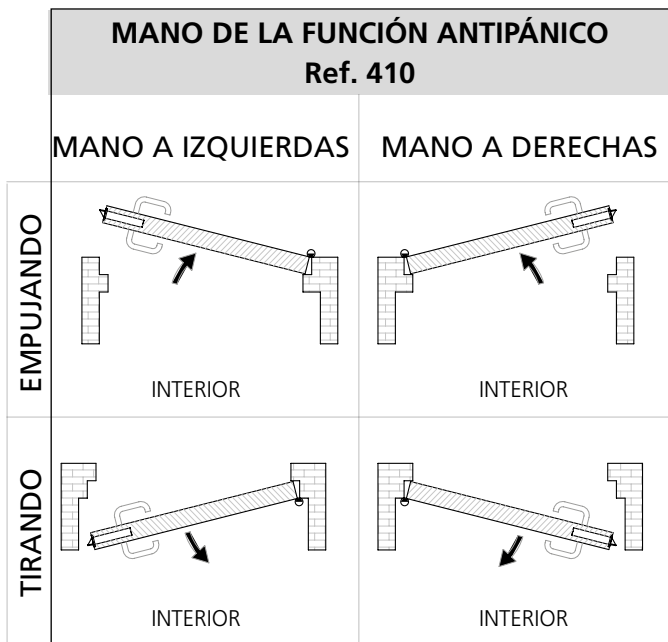





**BARRA ANTIPÁNICO DE CIERRE LATERAL CON MARCADO CE**

**SERIE 5000**

**CARACTERÍSTICAS**

- 1 punto de cierre lateral
- Solución reversible
- Cerradero CE5000
- Certificado CE según norma europea UNE-EN 1125
- Cortafuego

**ACCESORIOS OPCIONALES**

- Barra de apoyo de medidas especiales
- Manilla y escudo en negro M5000, M5001, M5002, M5003
- Manilla y escudo de acero inoxidable CM5006, CM5007, para distintos entre ejes
- Cilindro B5000



ANTIPÁNICO INOX



ANTIPÁNICO NIQUEL MATE



ANTIPÁNICO NEGRO

DESCRIPCIÓN	REF.	ACABADOS		UDS	
		SOPORTE	BARRA		
	5000/1N	Pintado negro	Pintado rojo	1	5
	5000/1NM	Níquel mate	Acero inoxidable Aisi 304L	1	5
	5000/6	Acero inoxidable Aisi 304L	Acero inoxidable Aisi 304L	1	5



## BARRA ANTIPÁNICO ACOPLABLE A CERRADURA DE EMBUTIR CON MARCADO CE

## SERIE 5500

### CARACTERÍSTICAS

- Acoplable a cerradura de embutir
- Solución reversible
- Certificado CE según norma europea UNE-EN 1125 con la serie 400T y 400LT, pág. 157
- Cortafuego

### ACCESORIOS OPCIONALES

- Barra de apoyo de medidas especiales



ANTIPÁNICO INOX



ANTIPÁNICO NÍQUEL MATE



ANTIPÁNICO NEGRO

### DESCRIPCIÓN

### REF.

### ACABADOS

### UDS

### SOPORTE

### BARRA

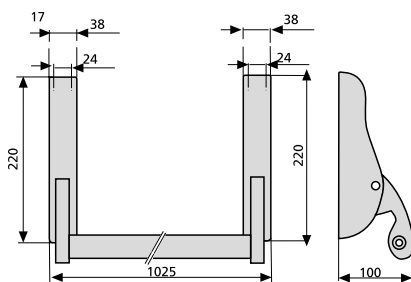

5500/1N	Pintado negro	Pintado rojo	1	5
5500/1NM	Níquel mate	Acero inoxidable Aisi 304L	1	5
5500/6	Acero inoxidable Aisi 304L	Acero inoxidable Aisi 304L	1	5



**BARRA ANTIPÁNICO DE CIERRE ALTO-BAJO CON MARCADO CE**

**SERIE 6000**

**CARACTERÍSTICAS**

- 2 puntos de cierre alto-bajo
- Reversible sin accionamiento exterior
- Cerradores CER5000 y CEB6000
- Certificado CE según norma europea UNE-EN 1125
- Cortafuego

**ACCESORIOS OPCIONALES**

- Barra de apoyo y fallebas de medidas especiales
- Manilla y escudo en negro M5000, M5001, M5002, M5003
- Manilla y escudo de acero inoxidable CM5006, CM5007 para distintos entre ejes
- Cilindro B5000



**DESCRIPCIÓN**

**REF.**

**SOPORTE**

**ACABADOS**

**BARRA**

**FALLEBA**

**UDS**

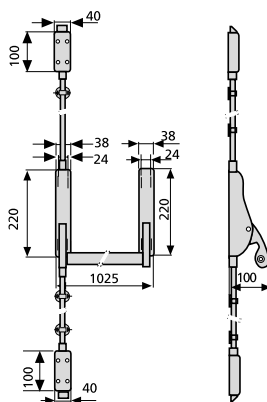

6000D/1N	Pintado negro	Pintado rojo	Pintado negro	1	5
6000I/1N	Pintado negro	Pintado rojo	Pintado negro	1	5
6000D/1NM	Níquel mate	Acero inoxidable Aisi 304L	Acero inoxidable Aisi 304L	1	5
6000I/1NM	Níquel mate	Acero inoxidable Aisi 304L	Acero inoxidable Aisi 304L	1	5
6000D/6	Acero inoxidable Aisi 304L	Acero inoxidable Aisi 304L	Acero inoxidable Aisi 304L	1	5
6000I/6	Acero inoxidable Aisi 304L	Acero inoxidable Aisi 304L	Acero inoxidable Aisi 304L	1	5



**CARACTERÍSTICAS**

- Cerradura con función antipánico para puertas de aluminio y metálicas
- Sistema antipánico reversible
- Frente inox. de 22 mm
- Picaporte reversible de 11 mm de hierro
- Picaporte regulable, excepto en entrada de 25 mm
- Caja de 15 mm
- Cuadradillo de 8 mm
- Operado mediante llave y pomo o manilla desde el exterior
- Tornillo de fijación de cilindro
- Entre ejes 85 mm (615) ó 92 mm (612)
- Ensayado a fuego

**ACCESORIOS OPCIONALES**

- Gama completa de cerraderos (ver páginas 44 - 51)
- Gama completa de cilindros (ver página 128 - 148)

DESCRIPCIÓN	REF.	MEDIDAS		LEVA	ACABADOS		UDS
		B	A		FRENTE	CANTO	

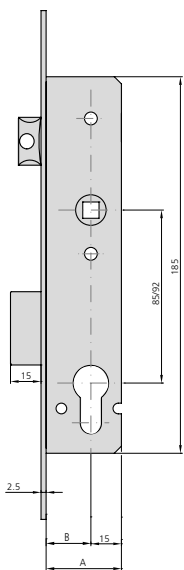

- Picaporte y palanca
- Cilindro no incluido
- Cerradura con nueca partida
- Opciones de cerradero (ver páginas 44 - 51)
- Opciones de cerradero eléctrico (ver página 52)

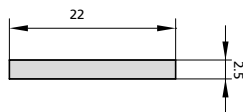

615/25/6	22	37	15	Al		1	20
615/30/6	27	42	15	Al		1	20
615/35/6	32	47	15	Al		1	20
612/25/6	22	37	15	Al		1	20
612/30/6	27	42	15	Al		1	20
612/35/6	32	47	15	Al		1	20

**CERRADURA ANTIPÁNICO PALANCA DESLIZANTE**
**SERIES 615E, 612E**

**CARACTERÍSTICAS**

- Cerradura con función antipánico para puertas de aluminio y metálicas
- Sistema antipánico reversible
- Frente inox de 22 mm
- Picaporte reversible de 11 mm de hierro
- Picaporte regulable, excepto en entrada de 25 mm
- Caja de 15 mm
- Cuadradillo de 8 mm
- **Operado mediante llave y manilla desde el exterior. La llave bloquea o desbloquea la manilla**
- Tornillo de fijación de cilindro
- Entre ejes 85 mm (615E) ó 92 mm (612E)
- Ensayado a fuego

**ACCESORIOS OPCIONALES**

- Gama completa de cerraderos (ver páginas 44 - 51)
- Gama completa de cilindros (ver página 128 - 148)

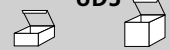
**DESCRIPCIÓN**
**REF.**
**MEDIDAS  
B A**
**LEVA**
**ACABADOS  
FRENTE CANTO**
**UDS**

- Picaporte y palanca
- Cilindro no incluido
- Opciones de cerradero (ver páginas 44 - 51)
- Opciones de cerradero eléctrico (ver página 52)

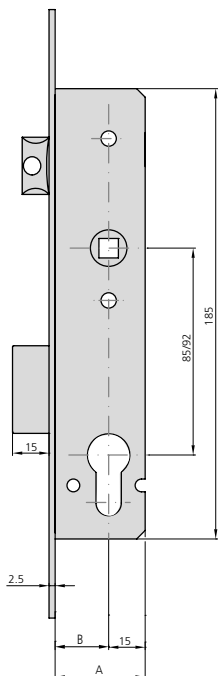
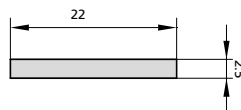

615E/25/6	22	37	15	Al	1	20
615E/30/6	27	42	15	Al	1	20
615E/35/6	32	47	15	Al	1	20
612E/25/6	22	37	15	Al	1	20
612E/30/6	27	42	15	Al	1	20
612E/35/6	32	47	15	Al	1	20

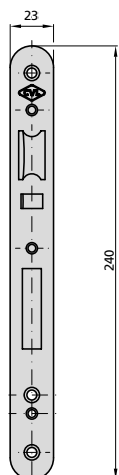

**CARACTERÍSTICAS**

- Frente en acero inoxidable en canto redondo o cuadrado
- Caja niquelada
- Cuadradillo de 8 mm
- Resbalón de hierro
- Tornillo de fijación de cilindro
- Cerradero de acero inoxidable en canto redondo o cuadrado
- Ensayado a fuego
- Ensayado según UNE EN 12209

**ACCESORIOS OPCIONALES**

- Gama completa de cilindros (ver página 128 - 148)

DESCRIPCIÓN	REF.	MEDIDAS		LEVA	ACABADOS		UDS	
		B	A		FRENTE	CANTO		
<ul style="list-style-type: none"> <li>• Cerradura con picaporte y palanca rectangular</li> <li>• Cerradura con función antitarjeta</li> </ul>	400L60/6HP	60	90	S. CIL	AI	Red	1	12

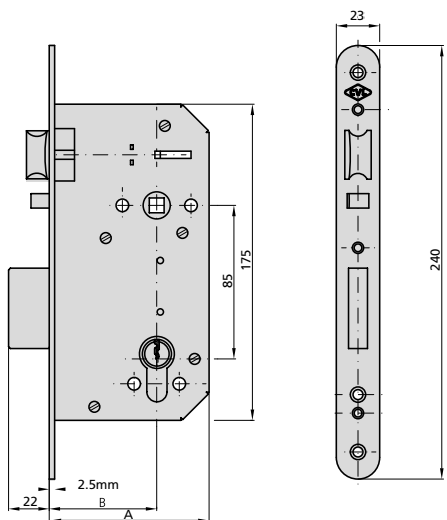

• Cerradura con picaporte y palanca rectangular	400/50/6HP	50	80	S. CIL	AI	Red	1	12
	400/60/6HP	60	90	S. CIL	AI	Red	1	12

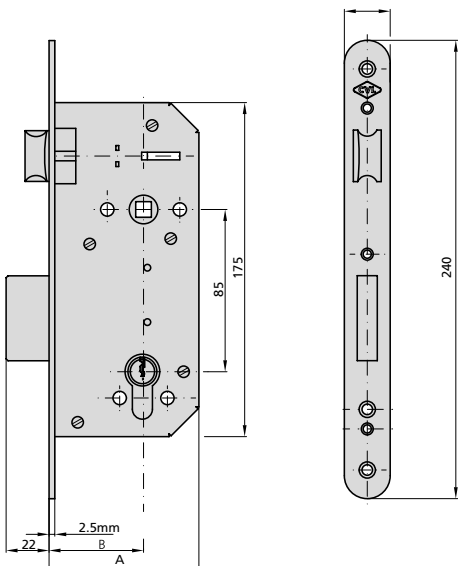

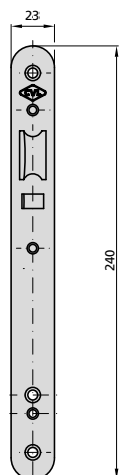
**CARACTERÍSTICAS**

- Frente en acero inoxidable en canto redondo o cuadrado
- Caja niquelada
- Cuadradillo de 8 mm
- Resbalón de hierro
- Tornillo de fijación de cilindro
- Cerradero de acero inoxidable en canto redondo o cuadrado
- Certificado CE según norma UNE-EN 1125 con la barra antipánico ref. 5500

**ACCESORIOS OPCIONALES**

- Gama completa de cilindros (ver página 128 - 148)

DESCRIPCIÓN	REF.	MEDIDAS		LEVA	ACABADOS		UDS	
		B	A		FRENTE	CANTO		

- Cerradura con sólo picaporte de acero
- Cerradura con función antitarjeta

400LT60/6H	60	90	S. CIL	Al	Red	1	12
------------	----	----	--------	----	-----	---	----

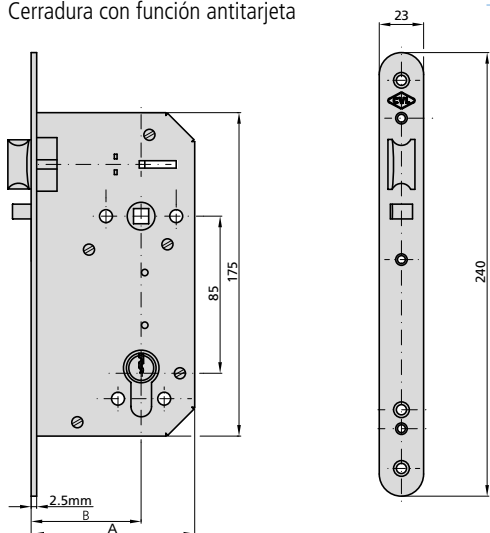

- Cerradura con solo picaporte de acero

400T50/6H	50	80	S. CIL	Al	Red	1	12
400T60/6H	60	90	S. CIL	Al	Red	1	12

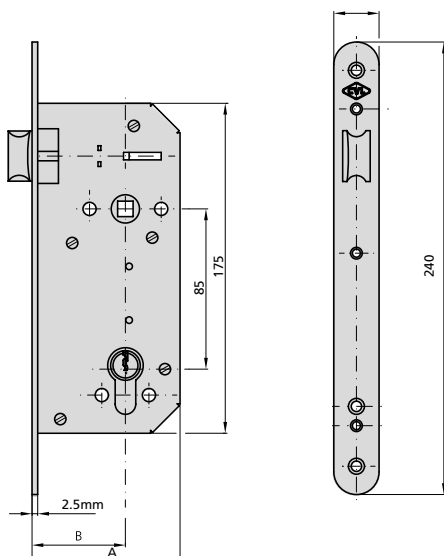





**CARACTERÍSTICAS**

- Cerradura cortafuego con función antipánico
- Frente de acero inoxidable en canto redondo o cuadrado
- Caja niquelada
- Cuadradillo de 8 mm
- Certificado CE según norma EN179 con manilla CM5006 (pág. 161)
- Cortafuego
- Cerraderos de acero inoxidable en canto redondo o cuadrado
- Tornillo de fijación de cilindro

**ACCESORIOS OPCIONALES**

- Gama completa de cilindros (ver página 128 - 148)

DESCRIPCIÓN	REF.	MEDIDAS		LEVA	ACABADOS		UDS	
		B	A		FRENTE	CANTO		
• Cerradura con picaporte y palanca rectangular	410L60D/6HP	60	90	S. CIL	Al	Red	1	12
• Cerradura con función antitarjeta	410L60I/6HP	60	90	S. CIL	Al	Red	1	12
• Cerradura con función antipánico								
• Cerradura con nueca partida								

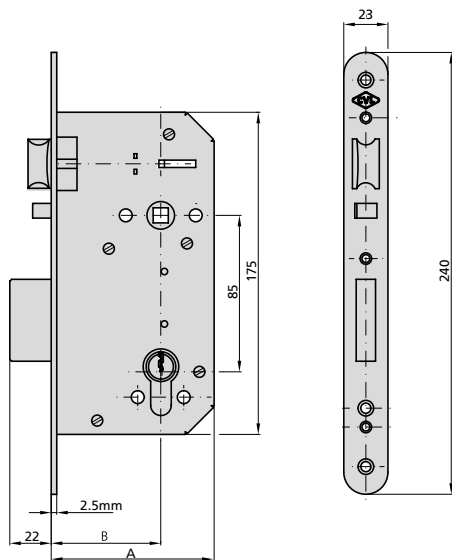



DESCRIPCIÓN	REF.	MEDIDAS		LEVA	ACABADOS		UDS	
		B	A		FRENTE	CANTO		
• Cerradura con picaporte y palanca	410/50D/6HP	50	80	S. CIL	Al	Red	1	12
• Cerradura con función antipánico	410/50I/6HP	50	80	S. CIL	Al	Red	1	12
• Cerradura con nueca partida	410/60D/6HP	60	90	S. CIL	Al	Red	1	12
	410/60I/6HP	60	90	S. CIL	Al	Red	1	12

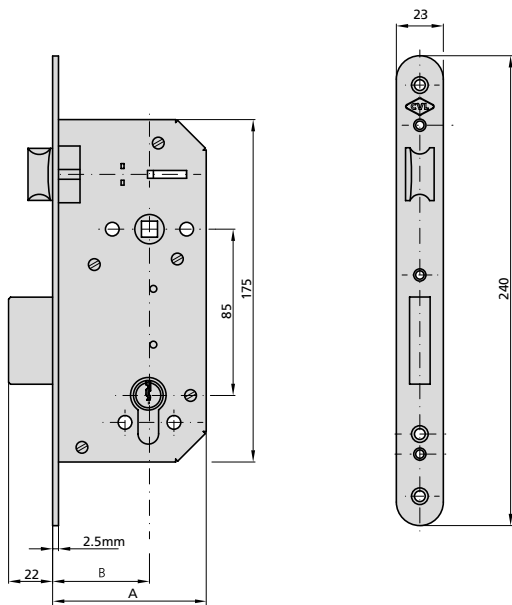

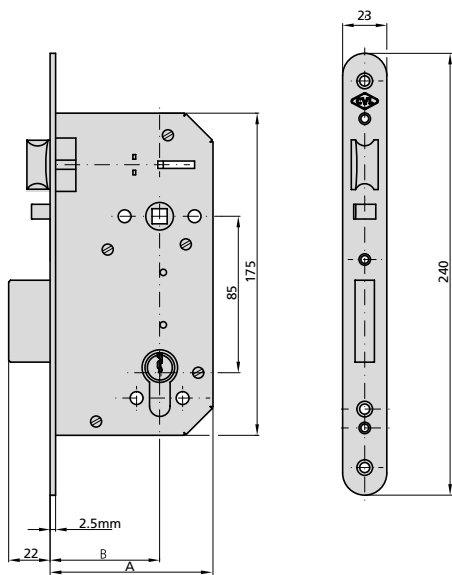

- Cerradura con picaporte y palanca rectangular
- Cerradura con función antitarjeta
- Cerradura con función antipánico
- Cerradura con nueca pasante

410L60/6HP	60	90	S. CIL	Al	Red	1	12
------------	----	----	--------	----	-----	---	----



# CERRADURA ANTIPÁNICO PARA VÍAS DE ESCAPE CON MARCADO CE

# SERIE 410

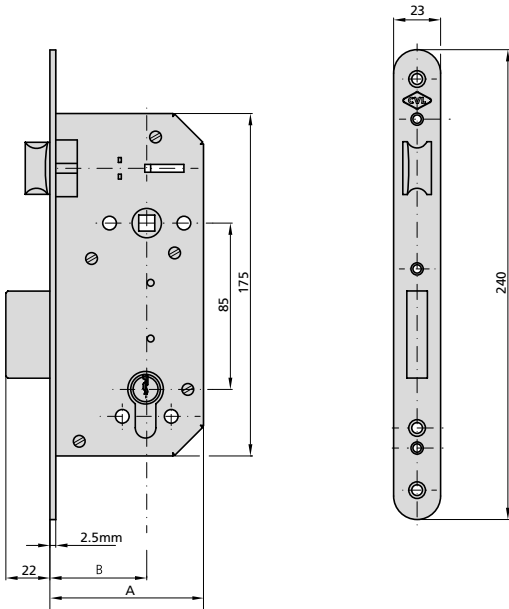

DESCRIPCIÓN	REF.	MEDIDAS		LEVA	ACABADOS		UDS	
		B	A		FRENTE	CANTO		
• Cerradura con picaporte y palanca	410/50/6HP	50	80	S. CIL	Al	Red	1	12
• Cerradura con función antipánico	410/60/6HP	60	90	S. CIL	Al	Red	1	12
• Cerradura con nueca pasante								



**ACCESORIOS**
**ESCUDOS Y MANILLAS DE ACERO INOXIDABLE**

**CARACTERÍSTICAS**

- Manillas de acero inoxidable certificadas en procedimientos de ensayo de la norma EN 179

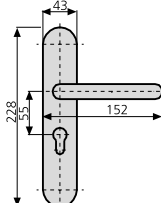
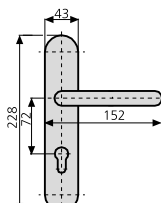
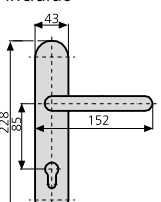
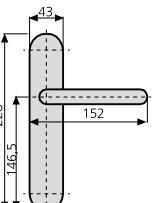
DESCRIPCIÓN	REF.	ACABADO	CANTO	UDS  
<ul style="list-style-type: none"> <li>Escudo con manilla y bocallave cilindro</li> <li>Entre ejes 55 mm</li> <li>Cilindro no incluido</li> </ul> 	CM5006I55/6R CM5006D55/6R	AI AI	Red Red	1 1
<ul style="list-style-type: none"> <li>Escudo con manilla y bocallave cilindro</li> <li>Entre ejes 72 mm</li> <li>Cilindro no incluido</li> </ul> 	CM5006I72/6R CM5006D72/6R	AI AI	Red Red	1 1
<ul style="list-style-type: none"> <li>Escudo con manilla y bocallave cilindro</li> <li>Entre ejes 85 mm</li> <li>Cilindro no incluido</li> </ul> 	CM5006I85/6R CM5006D85/6R	AI AI	Red Red	1 1
<ul style="list-style-type: none"> <li>Escudo con manilla</li> </ul> 	CM5007I/6R CM5007D/6R	AI AI	Red Red	1 1

ACCESORIOS

ESCUDOS Y MANILLAS EN NEGRO



CARACTERÍSTICAS

- Manillas pintadas en negro

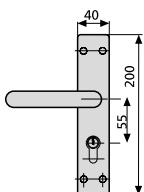
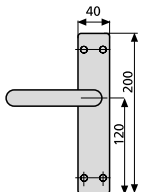
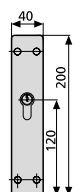
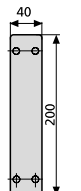
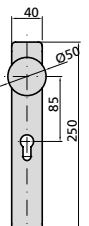
DESCRIPCIÓN	REF.	ACABADO	CANTO	UDS
 <ul style="list-style-type: none"> <li>• Escudo con manilla y bocallave cilindro</li> <li>• Entre ejes 55 mm</li> <li>• Incluye cilindro B5000</li> </ul>	M5000D/1N M5000I/1N	Negro Negro	Cua Cua	1 1
 <ul style="list-style-type: none"> <li>• Escudo con manilla</li> </ul>	M5001D/1N M5001I/1N	Negro Negro	Cua Cua	1 1
 <ul style="list-style-type: none"> <li>• Escudo con bocallave cilindro</li> <li>• Entre ejes 55 mm</li> <li>• Incluye cilindro B5000</li> </ul>	M5002/1N	Negro	Cua	1
 <ul style="list-style-type: none"> <li>• Escudo ciego</li> </ul>	M5003/1N	Negro	Cua	1
 <ul style="list-style-type: none"> <li>• Escudo con tirador y bocallave</li> <li>• Incluye cilindro B5000</li> </ul>	M5004/1N	Negro	Cua	1

DESCRIPCIÓN	REF.	ACABADO	UDS
• Cilindro para barra antipánico	B5000	CL	1
	B5000/4	CN	1

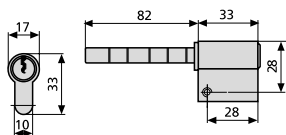

DESCRIPCIÓN	REF.	ACABADO
• Barra de apoyo Ø25*1000 mm	BAR5000/6	Al
• Barra de apoyo Ø25*1500 mm	BAR5000/6E	Al
• Barra de apoyo Ø25*1000 mm	BAR5000/1R	HE rojo
• Barra de apoyo Ø25*1500 mm	BAR5000/1RE	HE rojo
• Barra de apoyo Ø25*2000 mm	BAR5000/1RE2	HE rojo
• Tubo falleba Ø12*1000 mm	TUF6000/6	Al
• Tubo falleba Ø12*1500 mm	TUF6000/6E	Al
• Tubo falleba Ø12*1000 mm	TUF6000/1N	HE negro
• Tubo falleba Ø12*1500	TUF6000/1NE	HE negro
• Tubo falleba Ø12*2000	TUF6000/1NE2	HE negro
• Cerradero lateral	CE5000/1N	HE negro
• Cerradero lateral	CE5000/6	Al
• Cerradero bajo	CEB6000/1N	Acero microfundido negro
• Cerradero bajo	CEB6000	Acero microfundido







## CONTROL DE ACCESOS

Dispositivos de apertura

166

## DISPOSITIVOS DE APERTURA

	DESCRIPCIÓN	REF.
	<ul style="list-style-type: none"> <li>• Kit control de acceso de apertura con tarjeta de proximidad.</li> <li>• Listo para utilizar:               <ul style="list-style-type: none"> <li>- Incluye tarjetas programado y borrado.</li> <li>- Sin necesidad de software.</li> </ul> </li> <li>• Incluye cable lector.</li> <li>• Posibilidades amplias de amaestramiento.</li> </ul>	KLECP1
	Llavero programable	LLAVERO1
	Pegatina o Tag programable	TAG1
	Tarjeta programable	TARJ1
 ©ekey biometric systems	<ul style="list-style-type: none"> <li>• Lector de huella autónomo mediante tecnología bluetooth.</li> <li>• Grabación sencilla de huellas a través de app gratuita.</li> <li>• Posibilidad de hasta 99 huellas.</li> <li>• Incluye cableado para instalación.</li> <li>• No incluye pasacables.</li> <li>• Tiene que llevar pasacables.</li> </ul>	KLECH1/6
 ©ekey biometric systems	<ul style="list-style-type: none"> <li>• Lector de teclado para apertura de puerta.</li> <li>• Panel táctil de cristal negro.</li> <li>• Posibilidad de programar hasta 99 secuencias numéricas de 4 a 8 dígitos.</li> <li>• Incluye cableado para instalación.</li> <li>• No incluye pasacables.</li> <li>• Tiene que llevar pasacables.</li> </ul>	KLECT1/N
	<ul style="list-style-type: none"> <li>• Pasacable oculto en la hoja o en el marco.</li> <li>• Diámetro interior 9,4mm.</li> <li>• Diámetro exterior 11,8mm.</li> <li>• Longitud de tubo 290mm.</li> </ul>	PASCABO1
	<ul style="list-style-type: none"> <li>• Pasacables de sobrepone para pasar electricidad del marco a la hoja.</li> </ul>	PASCABS1
	<ul style="list-style-type: none"> <li>• Fuente de alimentación 12VDC 3A 230V AC/36VA.</li> </ul>	FA12VDC3A1



## LLAVE SERRETA

### DESCRIPCIÓN

Cilindro largo especial  
 Maestramiento. 1 lado  
 Maestramiento. 2 lados  
 Gran Maestra. Un lado  
 Gran Maestra. Dos lados  
 Cilindro con llaves iguales  
 Cilindro con llaves según muestra

Llave suplementaria (125)  
 Llave sin mecanizar (125)  
 Llave mecanizada según muestra (125)

## LLAVE SEGURIDAD

### DESCRIPCIÓN

Maestramiento. 1 lado  
 Maestramiento. 2 lados  
 Llave suplementaria  
 Llave sin mecanizar  
 Llave mecanizada según muestra  
 Cilindro con llaves iguales  
 Cilindro con llaves según muestra

## OTROS

Reductor metálico

Rgo. alargamiento de cilindro redondo (60, 70, 80 mm) cerradura sobreponer  
 Rgo. alargamiento de cilindro redondo (90, 100, 110 mm) cerradura sobreponer

Rgo. configuración tarjeta Mifare

Rgo. frente 2300 mm  
 Rgo. frente 1500 mm

Kit condena leva corta aplicable a series 184, 192, 196, 194 (ref. 5990C16)  
 Kit condena leva larga aplicable a series 184, 192, 196, 194 (ref. 5982C16)  
 Kit condena leva corta aplicable a series 1984, 1985, 1983, 1992, 1970 (ref. 5990C20)  
 Kit condena leva larga aplicable a series 1984, 1985, 1983, 1992, 1970, 1960 (ref. 5982C20)





Sistemas Valle Leniz S.L.U. • Pol. Arbi Zelai • Apdo 6, 20550 • Aretxabaleta • Gipuzkoa (Spain)  
Tel: 943 79 10 16 • Fax: 943 79 25 46 • E-mail: cvl@cvl.es • Web: www.cvl.es