

DOGHER

® TOOLS

Making Solutions



458



472



459



473



464



474



465



475
476



466



468



470

Herramienta Variada 900

Herramienta Variada

Tronzatuercas



901

Tronzatuercas Profesional



mm	Part N°	€
3 ~ 12 mm	901-03-12	36,72
12 ~ 16 mm	901-12-16	42,88
16 ~ 22 mm	901-16-22	53,00

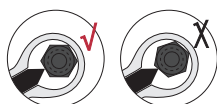

- Retira tuercas atascadas sin dañar la rosca.
- Coloque el tronzatuercas como se indica en el dibujo para un correcto uso de la herramienta.

905

Extractor con Masa de Inercia de Pasadores Roscados con Bocas M3-M4-M5-M6-M8-M10



Part N°	€
905-150	140,40



M12x1,5

905

Boca de Repuesto



Boca	Part N°	€
M3	905-103	12,98
M4	905-104	12,98
M5	905-105	12,98
M6	905-106	12,98
M8	905-108	12,98
M10	905-110	12,98

902

Extractor Reversible de 2 Patas

CrV

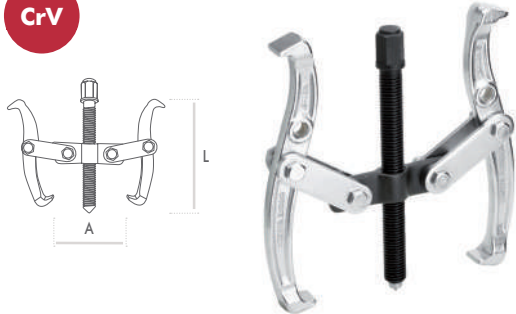

L mm	L"	A min-A max	Rosca	Tensión max.(KN)	Part N°	€
75	3"	15-80	Tr 12x2	11	902-075	44,42
100	4"	20-110	Tr 14x2,5	18	902-100	52,30
150	6"	25-160	Tr 17x2,5	30	902-150	70,08
200	8"	30-210	Tr 21x2,5	50	902-200	127,75
300	12"	50-310	Tr 30x4	98	902-300	275,35

903

Extractor Reversible de 3 Patas

CrV

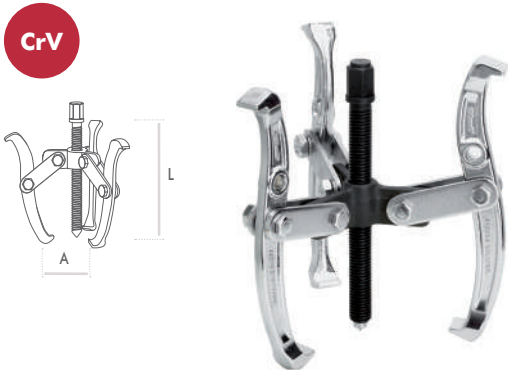

L mm	L"	A min-A max	Rosca	Tensión max.(KN)	Part N°	€
75	3"	15-80	Tr 12x2	16	903-075	53,30
100	4"	20-110	Tr 14x2,5	26	903-100	62,76
150	6"	25-160	Tr 17x2,5	44	903-150	84,08
200	8"	30-210	Tr 21x2,5	70	903-200	153,29
300	12"	50-310	Tr 30x4	110	903-300	403,45

900/902

Recambios para Extractores

L mm	L"	Garra		Husillo		Combinable con	L mm	L"	Cuerpo		Combinable con
		Part N°	€/u.	Part N°	€				Part N°	€	
75	3"	900-075G	22,21	900-075H	13,33	902-075 / 903-075	75	3"	902-075C	8,88	902-075
100	4"	900-100G	26,15	900-100H	15,69	902-100 / 903-100	100	4"	902-100C	10,46	902-100
150	6"	900-150G	28,03	900-150H	21,02	902-150 / 903-150	150	6"	902-150C	14,02	902-150
200	8"	900-200G	44,71	900-200H	38,32	902-200 / 903-200	200	8"	902-200C	25,55	902-200
300	12"	900-300G	110,14	900-300H	55,07	902-300 / 903-300	300	12"	902-300C	49,56	902-300

L mm	L"	Cuerpo		Combinable con
		Part N°	€	
75	3"	903-075C	10,66	903-075
100	4"	903-100C	12,55	903-100
150	6"	903-150C	16,82	903-150
200	8"	903-200C	30,66	903-200
300	12"	903-300C	80,69	903-300

Herramienta Variada

Extractores

DOGHER
°TOOLS

904

Extractor Universal Reversible de 2 Garras

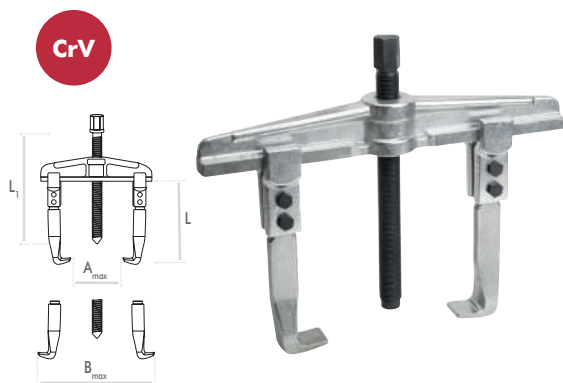

A min-A max	B min-Bmax	L	Rosca	L ₁	Tensión max.(KN)	Part N°	€
30-90	70-130	100	M14x1,5	130	30	904-90-100	75,58
35-130	80-180	100	M14x1,5	130	30	904-130-100	76,86
40-160	105-220	150	M20x2	210	42	904-160-150	127,47
40-200	120-270	150	M20x2	210	42	904-200-150	175,50
60-250	160-330	205	M27x2	280	60	904-250-200	320,25
60-350	160-420	205	M27x2	280	60	904-350-200	349,87
90-520	195-600	205	M27x2	280	60	904-520-200	599,57

904

Recambios para Extractores

L mm	L"	Garra		Husillo		Combinable con
		Part N°	€/u.	Part N°	€	
100	4"	904-001G	30,23	904-001H	22,67	904-90-100 / 904-130-100
150	6"	904-002G	50,99	904-002H	38,24	904-160-150 / 904-200-150
200	8"	904-003G	128,10	904-003H	64,05	904-160-150 / 904-200-150 / 904-200-150

L mm	L"	Cuerpo		
		Part N°	€	Combinable con
100	4"	904-90-100C	30,23	904-90-100
100	4"	904-130-100C	32,28	904-130-100
150	6"	904-160-150C	50,99	904-160-150
150	6"	904-200-150C	70,20	904-200-150
200	8"	904-250-200C	89,67	904-250-200
200	8"	904-350-200C	104,96	904-350-200
200	8"	904-520-200C	329,76	904-520-200

Extractores

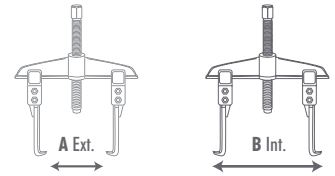

905

Extractor múltiple de 2 patas

CrV

100 mm

200 mm

250 mm



L mm	A min-A max	B min-B max	Part N°	€
100-250	30-140	55-170	905-001	253,25

Cuerpo	
Part N°	€
905-001C	75,97

Husillo	
Part N°	€
905-001H	50,65

		Garra	
L mm	L"	Part N°	€/u.
100	4"	905-001G1	43,05
200	8"	905-001G2	53,18
250	10"	905-001G3	70,91

905

Extractor múltiple de 3 patas

CrV

100 mm

200 mm

250 mm



L mm	A min-A max	B min-B max	Part N°	€
100-250	30-140	70-170	905-002	362,96

Cuerpo	
Part N°	€
905-002C	90,74

Husillo	
Part N°	€
905-001H	50,65

		Garra	
L mm	L"	Part N°	€/u.
100	4"	905-001G1	43,05
200	8"	905-001G2	53,18
250	10"	905-001G3	70,91

Herramienta Variada

Extractores



905

Extractor múltiple de 3 patas

CrV

200
mm

300
mm



L mm	A min-A max	B min-B max	Part N°	€
200-300	40-220	110-270	905-003	449,03

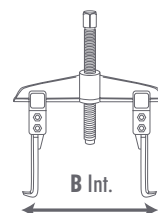
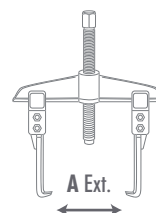

Cuerpo	Part N°	€
	905-003C	121,24

Husillo	Part N°	€
	905-003H	89,81

		Garra	
L mm	L"	Part N°	€/u.
200	8"	905-003G2	94,30
250	10"	905-003G3	103,28

905

Extractor múltiple de 2 y 3 patas

CrV

100
mm

200
mm

250
mm



905-001

905-002

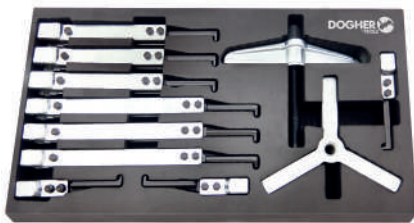

905-001



905-002

L mm	A min-A max	B min-B max	Part N°	€
100-250	30-140	55-170	905-004	436,96

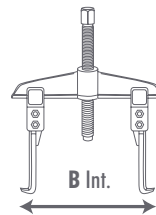
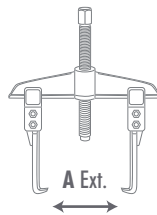

Cuerpo	Part N°	€
	905-001C	75,97
	905-002C	90,74

Husillo	Part N°	€
	905-001H	50,65

		Garra	
L mm	L"	Part N°	€/u.
100	4"	905-001G1	43,05
200	8"	905-001G2	53,18
250	10"	905-001G3	70,91

Herramienta Variada

Separadores de Guillotina



905

Juego de separadores de guillotina

CrV

30-50
mm

50-75
mm

min-max	Part N°	€
30-75	905-005	253,61



905

Separador de guillotina

CrV

30-50
mm



min-max	Part N°	€
30-50	905-006	51,65

905

Extractor para Guillotina



Part N°	€	
Compatible con 905-006	905-600	56,68

905

Separador de guillotina

CrV

50-75
mm



min-max	Part N°	€
50-75	905-007	69,69

905

Extractor para Guillotina



Part N°	€	
Compatible con 905-007	905-700	56,68

905

Separador de guillotina

CrV

75-105
mm



min-max	Part N°	€
75-105	905-008	93,61

905

Extractor para Guillotina



Part N°	€	
Compatible con 905-008	905-800	120,69

905

Separador de guillotina

CrV

100-150
mm



min-max	Part N°	€
100-150	905-009	264,53

905

Extractor para Guillotina



Part N°	€	
Compatible con 905-009	905-900	124,22

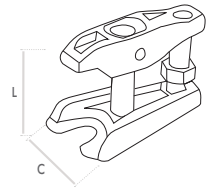

905

Extractor universal de rótulas

CrV

12-50
mm

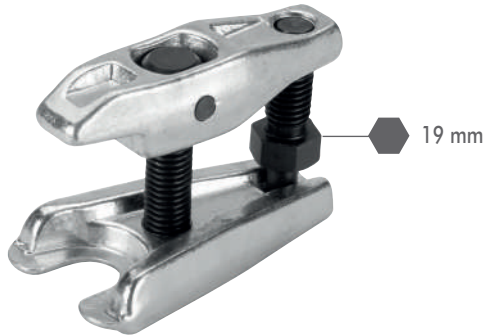

L min-max	C min-max	Part N°	€
12-50	18-22	905-010	29,67

905

Extractor de rótulas

CrV

12-50
mm

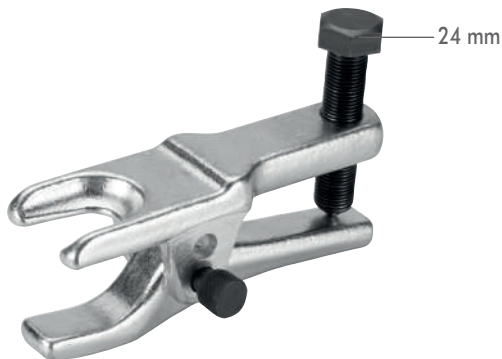

min-max	C	Part N°	€
12-50	20	905-011	57,84

905

Extractor de rótulas

CrV

60-80
mm



min-max	C	Part N°	€
60-80	20	905-012	75,15

Herramienta Variada

Pistolas Selladoras



910

Pistola Selladora Cuerpo de Acero

Ø mm
50



L mm	Ø mm	Part N°	€
225	50	910-225	6,83
250	50	910-250	7,12*

* Hasta fin de existencias

911

Pistola Selladora Mango de Zinc

Ø mm
50



L mm	Ø mm	Part N°	€
225	50	911-225	9,54

912

Pistola Selladora Mango de Aluminio

Ø mm
50



L mm	Ø mm	Part N°	€
225	55	912-225	20,85
250	55	912-250	20,70
360	55	912-325	26,36



- Mango y Cuerpo de Aluminio
- Antigoteo
- Fuerza de Empuje: 1500N
- Casquillo de Empuje Reforzado: 11mm
- Avance/Pulsación: 10mm
- Varilla de Empuje: 7,9mm



914

Pistola Selladora Triple Pistón

225
mm

9"



L mm	Ø mm	Part N°	€
225	78	914-225	33,36



915

Pistola Selladora con Corte

225
mm

9"

360°



L mm	Ø mm	Part N°	€
225	57	915-225	23,36



916

Pistola Selladora con Retroceso Rápido

225
mm

9"

360°



L mm	Ø mm	Part N°	€
225	55	916-225	21,22

Herramienta Variada

Pistolas para Espuma y Aplicador de Mortero

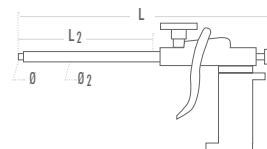

913

Aplicador de Mortero Cuerpo de Aluminio

Ø mm
50



L mm	Ø mm	Part N°	€
225	50	913-225	23,65
300	50	913-300	24,69
375	50	913-375*	28,17

- * Capacidad 600cm³ / Cartucho
- Casquillo de empuje reforzado.

Accesorios para Aplicador de Mortero

913

Boquillas de Repuesto para Aplicador de Mortero

2
Pcs

Apta para
913



Part N°	€/ 2Pcs
913-001	1,76

914

Pistola para Espuma Poliuretano Pro

Ø mm
11



L mm	L ₂ mm	Ø mm	Ø ₂ mm	Part N°	€
325	190	11	14	914-001	39,65

- Cuerpo reforzado. Varilla y válvula recubiertas exterior e interiormente de Teflón para garantizar una durabilidad mayor.

914

Pistola para Espuma Poliuretano

Ø mm
11



L mm	L ₂ mm	Ø mm	Ø ₂ mm	Part N°	€
325	180	11	12	914-002	29,91

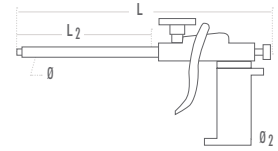

914 Pistola de Soplado Progresiva

Ø mm
8



L mm	L ₂ mm	Ø mm	Ø ₂ mm	Part N°	€
210	100	8	1/4" G (BSP)	914-010	18,40

- Presión máxima: 12 Bar · 175 PSI · 1,2 Mpa
- Boquilla con refuerzo metálico.
- Cuerpo de POM (Acetal) de alto rendimiento.

914 Pistola de Soplado Progresiva

Ø mm
8



L mm	L ₂ mm	Ø mm	Ø ₂ mm	Part N°	€
306	202	8	1/4" G (BSP)	914-015	21,58

- Presión máxima: 12 Bar · 175 PSI · 1,2 Mpa
- Boquilla con refuerzo metálico.
- Cuerpo de POM (Acetal) de alto rendimiento.

914 Pistola de Soplado Progresiva

Ø mm
8



L mm	L ₂ mm	Ø mm	Ø ₂ mm	Part N°	€
212	93	8	1/4" G (BSP)	914-020	23,31

- Bajo nivel de ruido
- Presión máxima: 12 Bar · 175 PSI · 1,2 Mpa
- Boquilla con refuerzo metálico.
- Cuerpo de POM (Acetal) de alto rendimiento.
- Fabricado bajo la normativa OSHA.
Administración de seguridad y salud ocupacional.



Herramienta Variada

Remachadoras



918

Remachadora Profesional

- Cabeza con boquilla intercambiable
- Incluye 4 bocas \varnothing 2,4-3,2-4-4,8 mm.
- Incorpora muelle expulsor de remache
- Mango ergonómico antideslizante



Part N°	€
918-010	39,79

918

Juego de Bocas de Repuesto

- 4 Bocas de repuesto para remachadora Ref. 918-010
- Incluye 1x \varnothing 2,4-3,2-4-4,8 mm



Part N°	€
918-1	4,18

918

Remachadora Automática

4 en 1

- Boquilla múltiple
- 4 Tamaños de remache \varnothing 2,4-3,2-4-4,8 mm
- Incorpora muelle expulsor de remache
- Mango ergonómico antideslizante



Part N°	€
918-012	34,69

919

Remachadora a Dos Manos

- Mordazas de Metal Duro
- Multiplicador de Fuerza Interno
- Mangos Ergonómicos
- Cuerpo de Aluminio
- Para Remaches de \varnothing 2,4-3,2-4-4,8-6,4 mm
- Remaches de Inoxidable: \varnothing 2,4-3,2-4-4,8 mm

XXTREME



L mm	L"	Part N°	€
320	13	919-016	73,42

919

Remachadora Manual Multifunción

XXTREME



3 en 1

Part N°	€
919-020	129,36



1 Remachadora



2 Remachadora para tuercas

2,4	3,2	4,0	4,8	6,4 mm	M3	M4	M5	M6	M8	M10
-----	-----	-----	-----	--------	----	----	----	----	----	-----



A



B

3 Escariador

919

Remachadora Manual para Tuercas

410 mm

16"



L mm	L"	Part N°	€
410	16	919-025	105,25

- Especial para trabajos intensivos.
- Remachadora ergonómica para reducir el esfuerzo.
- Fácil reemplazo de los componentes.
- Incluye llave multifunción

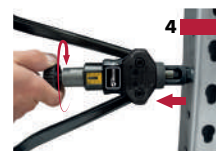
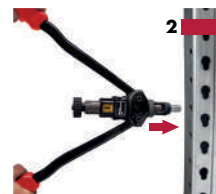

Herramienta Variada

Ventosas



945 Ventosa Profesional



Ø mm	Capacidad	Part N°	€
115	50 kg	945-001	18,14

- Cuerpo de aluminio con 1 cabezal.
- Uso con una mano.
- Ideal para trabajos en automoción o transporte de productos.
- Usar en superficies lisas no porosas.

945 Ventosa Profesional



Ø mm	Capacidad	Part N°	€
115	100 kg	945-002	36,28

- Cuerpo de aluminio con 2 cabezales.
- Ideal para trabajos en automoción o transporte de productos.
- Usar en superficies lisas no porosas.

945 Ventosa Doble Articulada Especial para Superficies Curvadas



Ø mm	Capacidad	Part N°	€
118	80 kg	945-005	43,55

- Cuerpo con 2 cabezales.
- Mango articulado, permite flexionar adaptándose a las superficies curvadas.
- Especial para el mantenimiento de vehículos, instalación y desinstalación de chapa y de cristal.

945 Ventosa Profesional



Ø mm	Capacidad	Part N°	€
115	130 kg	945-003	50,19

- Cuerpo de aluminio con 3 cabezales.
- Ideal para trabajos en automoción o transporte de productos pesados.
- Usar en superficies lisas no porosas.

945 Ventosa Profesional



Ø mm	Capacidad	Part N°	€
203	180 kg	945-004	95,56

- Ventosa de gran resistencia con bomba manual y disco de goma de 203 mm
- Marca roja de seguridad: aviso de pérdida de succión.
- Válvula de liberación de presión manual.
- Para uso en superficies estructuradas y abombadas.

945

Ventosa con Bomba de Vacío Especial para Lunas



Ø mm	Capacidad	Part N°	€
230	200 kg	945-006	165,36

- Cuerpo con 1 cabezal.
- Especial para Superficies curvas especialmente lunas.



930

Espejo Telescópico para Taller

Inox

- Espejo de calidad industrial permite una visualización perfecta en zonas de difícil acceso
- Espejo telescópico. Recogido: 240 mm. Extendido: hasta 930 mm
- Doble articulación permite posicionar el espejo en cualquier ángulo
- Mango antideslizante

360°



L min-max	Part N°	€
240-930	930-001	15,40



940

Sacabocados Profesional



- Orificios limpios y precisos en cuero, plástico, papel, tela...
- Ø 2-2,5-3-3,5-4-4,5 mm
- Mango ergonómico de PVC



Part N°	€
940-001	22,64

940

Sacabocados de Golpeo



- Mango moleteado antideslizante
- ø 2-2,5-3-3,5-4-4,5 mm

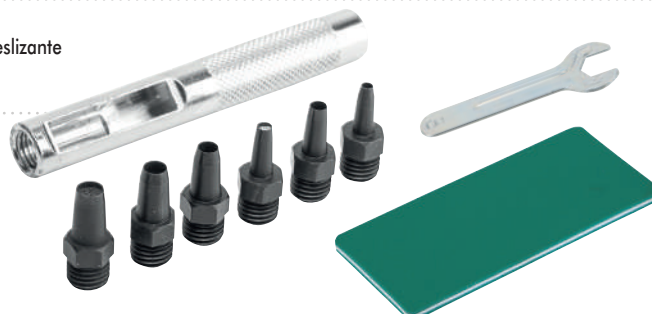

Part N°	€
940-002	20,58

Herramienta Variada

Tornillos de Banco Profesionales



925

Tornillo de Banco de Guía Redonda

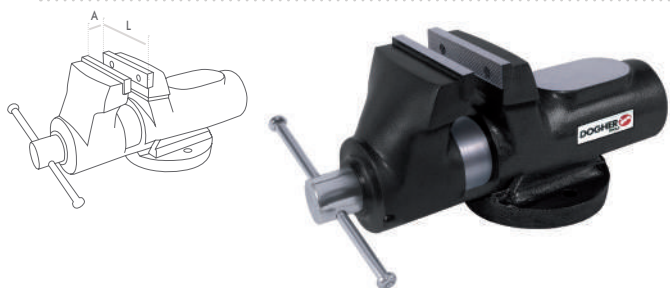

926

Tornillo de Banco de Guía Cuadrada



• Incluye Mordaza para Tubo

L mm	A mm	Kg	Part N°	€
100	105	13	925-100	323,26
125	130	22	925-125	445,10
150	165	32	925-150	635,55

L mm	A mm	Kg	Part N°	€
100	105	7,5	926-100	216,17
125	155	14	926-125	240,89
150	165	19	926-150	347,79
175	205	26	926-175	550,79

925R

Mordazas de Repuesto

Apta para
925

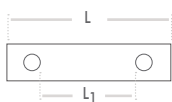

L mm	L1 mm	Part N°	€/ 2Pcs
100	53	925R-100	26,42
125	73	925R-125	39,10
150	88	925R-150	47,84

926R

Mordazas de Repuesto

Apta para
926

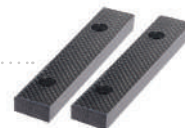
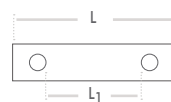

L mm	L1 mm	Part N°	€/ 2Pcs
100	24	926R-100	31,82
125	28	926R-125	37,54
150	43	926R-150	42,86
175	53	926R-175	47,98

925B

Base Giratoria

Apta para
925



L mm	Part N°	€
100	925B-100	32,36
125	925B-125	36,36
150	925B-150	52,36

926B

Base Giratoria

Apta para
926



L mm	Part N°	€
100	926B-100	31,41
125	926B-125	33,68
150	926B-150	43,26
175	926B-175	68,30

927

Tornillo de Sobremesa

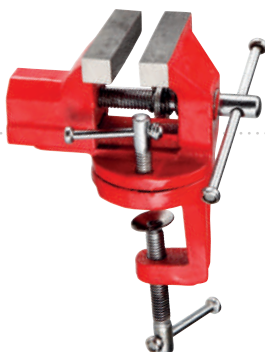

L mm	Part N°	€
90	927-060	32,25

905

Llave de Filtro 3 Garras Ajustable



Ø mm	Part N°	€
65-120	905-020	19,36

915

Bomba de Engrase con Manguera Rígida



L bomba	Ø bomba	L manguera	Ø manguera	Part N°	€
380	57,5	190	9,5	915-010	55,25

915

Bomba de Engrase con Manguera Flexible



915-020



915-030

L bomba	Ø bomba	L manguera	Ø manguera	Part N°	€
330	51,5	330	8,5	915-020	33,36
350	57,5	330	8,5	915-030	36,36

915

Manguera Flexible para Bomba



L mm	Part N°	€
300	915-021	7,36

Herramienta Variada

Sacabocados

XTREME

DOGHER
TOOLS

Sacabocados de cabezas intercambiables:

Los nuevos Sacabocados **XTREME** permiten al operario realizar orificios de precisión para la obtención de juntas, arandelas, etc.

Los cambios de bocas y mandrinos son rápidos mediante los sistemas de rosca o **FASTClick**.

Las bocas de 2 a 10mm de diámetro se unen al sacabocados mediante rosca interna de M13x1.

- Las bocas de 11 a 60 mm de diámetro se unen al sacabocados mediante el sistema **FASTClick**.
- Los mandrinos 940-250M y 940-260M se unen al sacabocados 940-02-60 mediante rosca de M20x1,5.

Su uso está recomendado en planchas de aluminio, acero, cuero, goma, cartón, espuma, plástico, fibra...

CAPACIDAD DE CORTE

Planchas de Acero-Cobre-Aluminio: 0,3 mm de espesor.



940

Sacabocados de Acero



L mm	Ø mm	Part N°	€
120	16	940-02-10	29,44

- Para Bocas de Ø 2 - 10 mm

940

Sacabocados de Acero



L mm	Ø mm	Part N°	€
95	24	940-03-20	40,11

- Para Bocas de Ø 2 - 20 mm

940

Sacabocados Bimaterial



L mm	Ø mm	Part N°	€
180	34,5	940-02-60	102,78

- Para Bocas de Ø 2 - 60 mm

940

Sacabocados Bimaterial



L mm	Ø mm	Part N°	€
180	35	940-03-30	111,91

- Para Bocas de Ø 2 - 30 mm

940

Boca de Repuesto Sacabocados

► Bocas Ø 2 - 10 mm
Rosca M13x1

L mm	Ø mm	Part N°	€
27	2	940-102	11,09
27	3	940-103	11,09
27	4	940-104	11,09
27	5	940-105	11,09
27	6	940-106	11,09
27	7	940-107	11,09
27	8	940-108	11,09
27	9	940-109	11,09
27	10	940-110	11,09

► Bocas Ø 11 - 60 mm



L mm	Ø mm	Part N°	€
27	11	940-111	13,78
27	12	940-112	13,78
27	13	940-113	13,78
27	14	940-114	13,78
27	15	940-115	13,78
27	16	940-116	13,78
27	17	940-117	13,78
27	18	940-118	13,78
27	19	940-119	13,78
27	20	940-120	13,78
32	21	940-121	18,22
32	22	940-122	18,22
32	23	940-123	18,22
32	24	940-124	18,22
32	25	940-125	18,22
32	26	940-126	18,22
32	27	940-127	18,22
32	28	940-128	18,22
32	29	940-129	18,22
32	30	940-130	18,22
37	32	940-132	23,47
37	33	940-133	23,47
37	34	940-134	23,47
37	35	940-135	23,47
37	36	940-136	23,47
37	37	940-137	23,47
37	38	940-138	23,47
37	39	940-139	23,47
37	40	940-140	23,47
42	42	940-142	27,22
42	43	940-143	27,22
42	44	940-144	27,22
42	45	940-145	27,22
42	46	940-146	27,22
42	47	940-147	27,22
42	48	940-148	27,22
42	49	940-149	27,22
42	50	940-150	27,22
47	52	940-152	69,44
47	54	940-154	69,44
47	56	940-156	69,44
47	58	940-158	69,44
47	60	940-160	69,44



Herramienta Variada

Sacabocados



940

Punta Centradora

Ø: 4,8 mm



Ø: 14 mm

L mm	Ø mm	Part N°	€
54	14	940-210	29,44

940

Barra para Compás

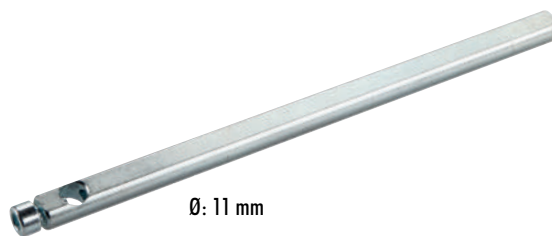

Ø: 11 mm

L mm	Ø mm	Part N°	€
420	11	940-211	18,02

940

Cutter para Compás



L mm	Ø mm	Part N°	€
124	16	940-212	26,78

• Incluye cuchilla 940-213

940

Cuchilla de Cutter para Compás



Part N°	€
940-213	17,78

940

Mandril Piramidal

Part N°	€
940-250M	71,36

• Se utiliza en el sacabocados 940-02-60
Incluido en el juego 940-250



Part N°	€
940-260M	103,02

• Se utiliza en el sacabocados 940-02-60
Incluido en el juego 940-260



940

Sacabocados Intercambiables Acero



940-03-20 Ø 2 - 20 mm



940-103 Ø 3
940-104 Ø 4
940-106 Ø 6
940-108 Ø 8
940-110 Ø 10



**Fast
Click**

940-112 Ø 12
940-114 Ø 14
940-116 Ø 16
940-118 Ø 18
940-120 Ø 20

Part N°	€
940-320	122,22



**11
Pcs**

940

Sacabocados Intercambiables Bimaterial



940-03-30 Ø 2 - 30 mm



940-103 Ø 3
940-104 Ø 4
940-106 Ø 6
940-108 Ø 8
940-110 Ø 10



**Fast
Click**

940-112 Ø 12
940-114 Ø 14
940-116 Ø 16
940-118 Ø 18
940-120 Ø 20
940-122 Ø 22
940-124 Ø 24
940-126 Ø 26
940-128 Ø 28
940-130 Ø 30

Part N°	€
940-330	245,00



**16
Pcs**

Herramienta Variada

Sacabocados



940

Sacabocados Intercambiables + Mandril + Punta Centradora



940-02-60 Ø 2 - 60 mm



940-102 Ø 2
940-103 Ø 3
940-104 Ø 4
940-105 Ø 5
940-106 Ø 6
940-107 Ø 7
940-108 Ø 8
940-109 Ø 9
940-110 Ø 10



940-112 Ø 12
940-114 Ø 14
940-116 Ø 16
940-118 Ø 18
940-120 Ø 20
940-122 Ø 22
940-124 Ø 24
940-126 Ø 26
940-128 Ø 28
940-130 Ø 30
940-132 Ø 32
940-134 Ø 34
940-136 Ø 36
940-138 Ø 38
940-140 Ø 40
940-142 Ø 42
940-144 Ø 44
940-146 Ø 46
940-148 Ø 48
940-150 Ø 50



940-210



940-250M Ø 2 - 50 mm

32
Pcs



Part N°	€
940-250	478,33

940

Sacabocados Intercambiables + Mandril + Punta Centradora + barra y Cutter para Compás



940-02-60 Ø 2 - 60 mm



940-102 Ø 2
940-103 Ø 3
940-104 Ø 4
940-105 Ø 5
940-106 Ø 6
940-107 Ø 7
940-108 Ø 8
940-109 Ø 9
940-110 Ø 10



940-112 Ø 12
940-114 Ø 14
940-116 Ø 16
940-118 Ø 18
940-120 Ø 20
940-122 Ø 22
940-124 Ø 24
940-126 Ø 26
940-128 Ø 28
940-130 Ø 30
940-132 Ø 32
940-134 Ø 34
940-136 Ø 36
940-138 Ø 38
940-140 Ø 40
940-142 Ø 42
940-144 Ø 44
940-146 Ø 46
940-148 Ø 48
940-150 Ø 50
940-152 Ø 52
940-154 Ø 54
940-156 Ø 56
940-158 Ø 58
940-160 Ø 60



940-210



940-260M Ø 2 - 60 mm



940-213



940-212



940-211

39
Pcs



Part N°	€
940-260	834,13