

**Херуц** / POWER  
TOOLS  
ACCESSORIES

**75** YEARS  
1947-2022



heryc.com

> 2022

# INDICE / SOMMAIRE / INDEX



- › Brocas para pared
  - › Foret Béton
  - › Masonry Drill bits
- Pag. 10-28**



- › Coronas para pared
  - › Scies tépans Béton
  - › Core Bits
- Pag. 29-31**

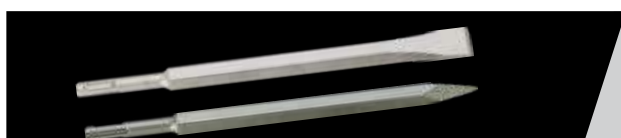

- › Punteros y Cinceles
  - › Pointerolles et Burins
  - › Pointers and Chisels
- Pag. 32-33**



- › Brocas para madera
  - › Forets à bois
  - › Wood drill-bits
- Pag. 34-47**



- › Brocas para metal
  - › Forets à métaux
  - › Metal Drill bits
- Pag. 48-53**



- › Brocas Escalonadas
  - › Fraises étagées
  - › Step Drill-Bits
- Pag. 54-55**



- › Coronas para metal
  - › Scies trépan métaux
  - › Metal Hole Saws
- Pag. 56-67**

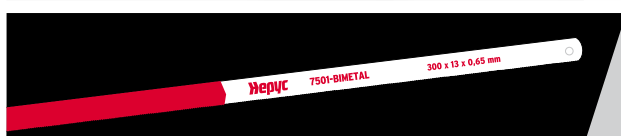

- › Sierras de Mano
  - › Lames de Scies à main
  - › Hand hacksaw blade
- Pag. 68-69**



- › Sierras de Calar
  - › Scies sauteuses
  - › Jig saws
- Pag. 70-71**



- › Sierras de sable
  - › Scies sabre
  - › Sabre saws
- Pag. 72-73**



























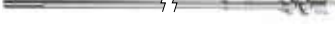































- › Oscilantes Multi-función /
  - › Outils Multifontions
  - › Oscillating Multi-tools
- Pag. 74-77**















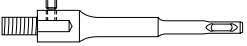
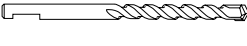
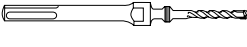

- › Portabrocas
  - › Mandrins
  - › Drill Chucks
- Pag. 78-80**



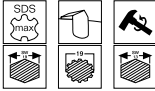
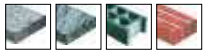
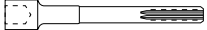
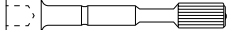

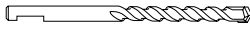

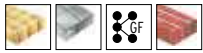
- › Expositores
  - › Présentoirs
  - › Displays
- Pag. 81-85**

Brocas para pared / Forets béton / Masonry drill-bits					
1201	Fasterplus (SDS+)		  	<b>Hormigón</b> Béton Concrete	 10
1223	Quatroqplus (SDS+)		  	<b>Hormigón armado</b> Béton armé Reinforced concrete	 13
1226	Compaqplus (SDS+)		  	<b>Hormigón armado</b> Béton armé Reinforced concrete	 16
1222	Performax (SDS max)		  	<b>Hormigón armado</b> Béton armé Reinforced concrete	 17
1203	Fastermax (SDS max)		  	<b>Hormigón armado</b> Béton armé Reinforced concrete	 18
1207	Optima		 	<b>Grés</b> Grès Stoneware	 20
1225	Perfecta		  	<b>Granito</b> Granit Granite	 21
1208	Diamond		  	<b>Hormigón</b> Béton Concrete	 22
1502	Diamond Hex.		  	<b>Hormigón</b> Béton Concrete	 24
1209	Marmolit			<b>Ladrillo</b> Brique Brick	 25
1227	Porceline		 	<b>Porcelanato</b> Céramique dur Hard tile	 27
1228	Porceline Widia			<b>Porcelanato</b> Céramique dur Hard tile	 28
1212	Vidrio			<b>Vidrio</b> Verre Glass	 28



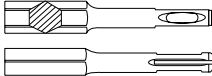

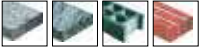
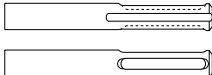



















Coronas pared / Scies-trépan béton / Core bits					
7121	SDS+		 	  	29
7122	MANGO HEXAGONAL				29
7123	MANGO SDS+				29
7124	BROCA DE CENTRAR				29
7153	MANGO BROCA				29

































7125	SDS MAX				30
7126	MANGO SDS MAX				30
7127	MANGO ESTRIADO				30
7128	MANGO SW19				30
7129	MANGO SW13				30
7130	BROCA DE CENTRAR				30
7154	TUNGSTENO				31
7160	BROCA DE CENTRAR				31
7161	HUSILLO HEXAGONAL				31

**Punteros y Cinceles / Pointeroles et Burins / Pointers and Chisels**

1401	SDS+				32
1405	SDS MAX				33

**Brocas para madera / Forets à bois / Wood drill-bits**

























1301	3P ST			CV	Maderas blandas Bois tendre Softwoods 	34
1503	3P ST HEX.			QUICK CHANGE   CV	Maderas blandas Bois tendre Softwoods 	36
1302	3 P PRO			HSS 	Maderas duras Bois dur Hardwoods 	37
1303	PALA STANDARD				Maderas blandas Bois tendre Softwoods 	38
1304	PALA PRO				Maderas duras Bois dur Hardwoods 	39
1305	PALA EXTENSIBLE				Maderas duras Bois dur Hardwoods 	40

1320	ALARGADOR				40
1306	LEWIS		 	Maderas duras Bois dur Hardwoods 	41
1321	LEWIS (SDS+)		  	Maderas duras Bois dur Hardwoods 	42
1307	ENCOFRAR			Encofrados Coffrages Shuttering 	43
1318	ENCOFRAR (SDS+)		 	Encofrados Coffrages Shuttering 	44
1308	AVELLANADOR		 	Maderas duras Bois dur Hardwoods 	45
<b>NEW</b> 1314	BROCA FORSTNER			Maderas duras Bois dur Hardwoods 	45
1309	CAZOLETA T1			Maderas duras Bois dur Hardwoods 	46
1310	CAZOLETA T2			Maderas duras Bois dur Hardwoods 	46
1311	CAZOLETA T3			Maderas duras Bois dur Hardwoods 	46

**Coronas madera / Scies-trépan bois / Wood core bits**

7149	MULTIUSOS		  	       	47
------	-----------	---	--	--	----

**Brocas para metal / Forets a metaux / Metal drill-bits**















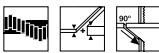





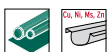
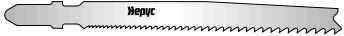
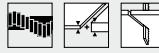

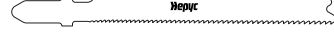
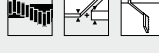

8163	RECTIFICADA (HSS DIN 338N)		  	Acero <80Kg Acier <80Kg Steel <80Kg 	48
1501	HSS HEX.		  	Acero <80Kg Acier <80Kg Steel <80Kg 	50
1154	SPEEDPLUS (HSS DIN 338NSP)		  	Acero <80Kg Acier <80Kg Steel <80Kg 	51
8164	COBALT (HSSCO DIN 338N)		  	Acero <120Kg Acier <120Kg Steel <120Kg 	52
8169	COBALT W (HSS DIN 338W)		  	Acero inox Acier inox Stainless steel 	53

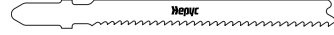
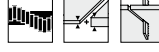
**Brocas escalonadas / Fraises étagées / Step drill-bits**

















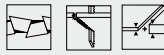
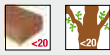



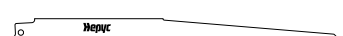

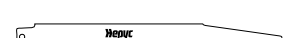
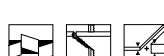

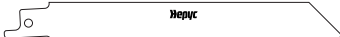

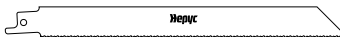



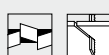

















5105	BROCA ESCALONADA (HSS)			Acero <80Kg Acier <80Kg Steel <80Kg 	54
5101	BROCA AVELLANADORA			Acero <80Kg Acier <80Kg Steel <80Kg 	55



Coronas metal / Scies-trépan métaux / Metal hole saws					
7111	BIMETAL M42			Acero <80Kg Acier <80Kg Steel <80Kg 	56
7110	BIMETAL DENTADO FINO M42			Acero <80Kg Acier <80Kg Steel <80Kg 	58
7142	BIMETAL DE CAMBIO RÁPIDO M42			Acero <80Kg Acier <80Kg Steel <80Kg 	59
7157	BIMETAL TCT			Acero inox Acier inox Stainless steel 	60
7112	HUSILLO HEXAGONAL				61
7112	HUSILLO EJE SDS+				61
7113	BROCA DE CENTRAR EJE L=85				61
7114	EXTENSIÓN EJE L=330				61
7140	HUSILLO CAMBIO RÁPIDO				61
7144	ADAPTADOR				61
7145	BROCA CENTRAR EJE L				61
7145	KIT CAMBIO RÁPIDO HUSILLO+ADAPTADOR				61
7101	TCT			Acero inox Acier inox Stainless steel 	62
7102	BROCA CENTRAR				63
7103	CONO MORSE				63
7104	HSS REAFILABLES			Acero inox Acier inox Stainless steel 	64
7105	HUSILLO				65
7106	CONO MORSE				65
7113	BROCA DE CENTRAR				65
	ESTUCHES / COFFRETS / CASES				66

Hojas de sierra de mano / Lame de scie à main / Hand hacksaw blade					
7501	BIMETAL			Acero <80Kg Acier <80Kg Steel <80Kg	68
7504	CV			Acero <80Kg Acier <80Kg Steel <80Kg	68
7505	CV			Acero <80Kg Acier <80Kg Steel <80Kg	69
Sierras de calar para madera / Scies sauteuses pour le bois / Jig saws for wood					
7604	HCS CARBONO				70
7603	HCS CARBONO				70
7624	HCS CARBONO				70
7614	HCS CARBONO				70
7601	HCS CARBONO				70
7602	HCS CARBONO				70
7621	HCS CARBONO				70
7622	HCS CARBONO				70
7642	HCS CARBONO				70
7643	HCS CARBONO				70
7644	HCS CARBONO				70
7623	BIMETAL				70
7645	HM				70
7646	BIMETAL				70

Sierras de calar para metal / Scies sauteuses pour métal / Jig saws for metal					
7626	HSS				70
7607	HSS				70
7609	HSS				70
7611	HSS				70
7647	HSS				70
7648	BIMETAL				70
7629	BIMETAL				70
7649	BIMETAL				70
7650	HM				70
7651	HM				70



Sierras de sable para madera / Scies sabre pour bois / Sabre saws for wood					
7701	HCS CARBONO				72
7702	HCS CARBONO				72
7703	HCS CARBONO				72
7704	BIMETAL				72
7705	BIMETAL				72
7706	BIMETAL				72
Sierras de sable para metal / Scies sabre pour métal / Sabre saws for metal					
7707	BIMETAL				72
7708	BIMETAL				72
7709	BIMETAL				72
7710	BIMETAL				72
7711	BIMETAL				72
7712	BIMETAL				72
7713	BIMETAL				72
Sierras de sable construcción / Scies sabre construction / Sabre saws for construction					
7714	BIMETAL				72
7715	BIMETAL				72
7719	BIMETAL				72
7717	HM				72
7718	HM				72

Oscilantes Multi-función / Outils Multifonctions / Oscillating Multi-tools					
7720 - 7725	MADERA / BOIS / WOOD				74
7726 - 7734	METAL				74
7735	METAL/INOX				74
7736 - 7747	ABRASIVO/ ESPECIAL ABRASIF/ SPÉCIAL ABRASIVE/SPECIAL				76
Portabrocas y accesorios / Mandrins et accessoires / Drill chucks and accessories					
6118	AUTOMATICO				78
6105	LLAVE PRO				78
6106	CON LLAVE				79
6117	SDS+				79
1224	ADAPTADOR SDS +				79
6107	ADAPTADOR BLACK&DECKER				80
6108	ADAPTADOR SDS+				80
6109	LLAVE RECAMBIO				80
EXPOSITORES / PRÉSENTOIRS / DISPLAY STANDS					81
					

**BROCAS PARA PARED  
FORETS BÉTON / MASONRY DRILL-BITS**



**APLICACIONES  
APPLICATIONS**



**Hormigón / Béton / Concrete**



**Granito  
Granit  
Granite**



**Ladrillo  
hormigón  
Brique béton  
Concrete brick**



**Ladrillo  
Brique  
Brick**

**Características  
Caractéristiques  
Features**



**Mango  
SDS+  
Queve SDS+  
SDS+ shank**



**Punta  
2 cortes  
Pointe 2 dents  
2-cut tip**



**Percusión  
y rotación  
Percussion  
et rotation  
Percussion  
and rotation**



**PGM**

**1201 Fasterplus (SDS+)**



Ø mm	L mm	l mm	clip		pack	
			Ref. 1201	Ref. 1201/1	Ref. 1201	Ref. 1201/1
4,00	110	50	5,53	1		
5,00	110	50	4,30	1	3,78	20
5,50	110	50	4,78	1		
6,00	110	50	4,32	1	3,86	20
7,00	110	50	5,94	1		
8,00	110	50	5,48	1	4,94	20
10,00	110	50	6,56	1		
5,00	160	100	5,11	1	4,55	20
5,50	160	100	5,28	1		
6,00	160	100	4,73	1	4,17	20
6,50	160	100	6,11	1		
7,00	160	100	6,31	1		
8,00	160	100	5,62	1	5,14	20
9,00	160	100	7,59	1		
10,00	160	100	6,72	1	6,11	20
11,00	160	100	9,17	1		
12,00	160	100	7,55	1	7,16	20
13,00	160	100	11,22	1		
14,00	160	100	11,22	1		
15,00	160	100	13,86	1		
5,00	210	150	8,70	1		
6,00	210	150	7,96	1		
6,50	210	150	9,67	1		
8,00	210	150	6,82	1		
9,00	210	150	9,06	1		
10,00	210	150	7,83	1	7,28	20
12,00	210	150	8,92	1	8,41	20
13,00	210	150	12,99	1		
14,00	210	150	12,80	1		
16,00	210	150	16,33	1		
17,00	210	150	27,72	1		
18,00	210	150	26,53	1		
20,00	210	150	30,14	1		
24,00*	210	150	56,35	1		
6,00	260	200	8,92	1		
6,50	260	200	15,00	1		
8,00	260	200	8,62	1		
10,00	260	200	9,93	1		
11,00	260	200	11,34	1		
12,00	260	200	11,49	1		
14,00	260	200	14,33	1		
15,00	260	200	18,41	1		
16,00	260	200	18,34	1		

(Hasta fin de existencias / Jusqu'à épuisement des stocks / While supplies last) (continúa Ref.1201 / suite Réf.1201 / Ref.1201 cont'd)

# BROCAS PARA PARED FORETS BÉTON / MASONRY DRILL-BITS

## 1201 Fasterplus (SDS+)



Ø mm	L mm	l mm	clip		pack	
			Ref. 1201	Ref. 1201/1	Ref. 1201	Ref. 1201/1
			€	€	€	€
22,00	260	200	39,89	1		
24,00	260	200	46,88	1		
25,00	260	200	50,14	1		
6,00	310	250	13,78	1		
8,00	310	250	12,52	1		
10,00	310	250	11,34	1		
12,00	310	250	13,84	1		
14,00	310	250	15,43	1		
16,00	310	250	18,95	1		
18,00	310	250	34,38	1		
20,00	310	250	38,21	1		
22,00*	310	250	50,90	1		
24,00*	310	250	74,18	1		
8,00	450	400	19,17	1		
10,00	450	400	16,75	1		
12,00	450	400	19,96	1		
14,00	450	400	24,02	1		
15,00	450	400	31,01	1		
16,00	450	400	32,71	1		
18,00	450	400	35,92	1		
20,00	450	400	41,18	1		
22,00	450	400	54,86	1		
24,00	450	400	56,11	1		
25,00	450	400	65,59	1		
26,00	450	400	61,24	1		
8,00	610	600	33,50	1		
10,00	610	600	30,16	1		
12,00	610	600	34,14	1		
14,00	610	600	36,57	1		
16,00	610	600	36,46	1		
18,00	610	600	54,94	1		

(Hasta fin de existencias / Jusqu'à épuisement des stocks / While supplies last)

### APLICACIONES APPLICATIONS



Hormigón / Béton / Concrete



Granito  
Granit  
Granite



Ladrillo  
hormigón  
Brique béton  
Concrete brick



Ladrillo  
Brique  
Brick

### Características Caractéristiques Features



Mango  
SDS+  
Queue SDS+  
SDS+ shank



Punta  
2 cortes  
Pointe 2 dents  
2-cut tip



Percusión  
y rotación  
Percussion  
et rotation  
Percussion  
and rotation



PGM

**BROCAS PARA PARED  
FORETS BÉTON / MASONRY DRILL-BITS**



**APLICACIONES  
APPLICATIONS**



**Hormigón / Béton / Concrete**



**Granito  
Granit  
Granite**



**Ladrillo  
hormigón  
Brique béton  
Concrete brick**



**Ladrillo  
Brique  
Brick**

**Características  
Caractéristiques  
Features**



**Mango  
SDS+  
Queve SDS+  
SDS+ shank**



**Punta  
2 cortes  
Pointe 2 dents  
2-cut tip**



**Percusión  
y rotación  
Percussion  
et rotation  
Percussion  
and rotation**



**PGM**

**1201 > Fasterplus (SDS+)**



Ø mm	L mm	l mm	clip		pack	
			Ref. 1201	Ref. 1201/1	€	€
20,00	610	600	56,06	1		
22,00	610	600	88,11	1		
25,00	610	600	89,78	1		
10,00	1000	940	70,82	1		
12,00	1000	940	77,66	1		
14,00	1000	940	89,02	1		
16,00	1000	940	88,91	1		
18,00	1000	940	110,93	1		
20,00	1000	940	124,88	1		
22,00	1000	940	127,32	1		
25,00	1000	940	151,91	1		

> Ref. 1217



Ø mm	L mm	pack
5,00	110	1
6,00	110	1
8,00	110	1
6,00	160	1
8,00	160	1
10,00	160	1
12,00	160	1
TOTAL		7
€		54,72

**1223 Quatroplus (SDS+)**



Ref. 1223

Ref. 1223/1

Ø mm	L mm	l mm	clip		pack	
			€	📦	€	📦
4	115	50	6,18	1		
5	110	50	6,18	1	5,57	5
5,5	110	50	6,73	1		
6	115	50	6,58	1	5,93	5
6,5	115	50	6,73	1		
7	110	50	6,67	1		
8	115	50	8,64	1	7,77	5
10	115	50	9,81	1	8,83	5
4	165	100	7,50	1		
5	160	100	7,50	1	6,75	5
5,5	160	100	6,29	1		
6	165	100	7,21	1	6,49	5
6,5	165	100	7,50	1		
7	165	100	7,53	1		
8	165	100	8,64	1	7,77	5
9	165	100	9,75	1		
10	165	100	10,48	1	9,43	5
11	165	100	11,13	1		
12	165	100	13,01	1	11,71	5
14	165	100	15,80	1		
15	165	100	20,14	1		
5	210	150	11,49	1		
5,5	210	150	11,71	1		
6	215	150	9,71	1	8,73	5
6,5	215	150	12,39	1		
7	215	150	12,19	1		
8	210	150	10,83	1	9,74	5
9	215	150	10,99	1		
10	215	150	12,52	1	11,27	5
11	215	150	13,25	1		
12	215	150	15,53	1	13,98	5
14	215	150	20,20	1		
16	215	150	32,37	1		
18	200	150	33,95	1		
20	200	150	36,08	1		
5	265	200	11,13	1		
6	265	200	11,64	1		
8	265	200	11,87	1		
10	265	200	16,11	1		
12	260	200	18,83	1		

**APLICACIONES**  
**APPLICATIONS**



**Hormigón armado**  
Béton armé  
Reinforced concrete



**Granito**  
Granit  
Granite



**Ladrillo hormigón**  
Brique béton  
Concrete brick



**Ladrillo**  
Brique  
Brick

**Características**  
Caractéristiques  
Features



**Mango SDS+**  
Queue SDS+  
SDS+ shank



**Percusión y rotación**  
Percussion et rotation  
Percussion and rotation



**PGM**

**BROCAS PARA PARED  
FORETS BÉTON / MASONRY DRILL-BITS**



**APLICACIONES  
APPLICATIONS**



**Hormigón armado  
Béton armé  
Reinforced concrete**



**Granito  
Granit  
Granite**



**Ladrillo hormigón  
Brique béton  
Concrete brick**



**Ladrillo  
Brique  
Brick**

**Características  
Caractéristiques  
Features**



**Mango SDS+  
Queue SDS+  
SDS+ shank**



**Percusión y rotación  
Percussion et rotation  
Percussion and rotation**



**PGM**

**1223 Quatroplus (SDS+)**



**Ref. 1223**

**Ref. 1223/1**

Ø mm	L mm	l mm	€	clip	pack
				Ref. 1223	Ref. 1223/1
14	265	200	22,58	1	
15	260	200	33,93	1	
16	265	200	37,43	1	
22	250	200	68,31	1	
24	250	200	70,49	1	
25	250	200	72,29	1	
26	250	200	76,37	1	
5	315	250	15,18	1	
6	315	250	15,18	1	
8	310	250	15,16	1	
10	315	250	20,48	1	
12	315	250	24,46	1	
14	315	250	28,95	1	
16	315	250	39,11	1	
18	300	250	40,70	1	
20	300	250	54,21	1	
8	365	300	18,19	1	
10	365	300	24,57	1	
12	365	300	29,35	1	
14	365	300	34,74	1	
16	360	300	46,94	1	
5	465	400	21,25	1	
6	465	400	23,43	1	
8	460	400	25,09	1	
10	465	400	28,10	1	
12	465	400	30,57	1	
14	465	400	36,26	1	
15	465	400	46,75	1	
16	465	400	49,00	1	
18	450	400	58,91	1	
20	450	400	67,52	1	
22	450	400	81,30	1	
24	450	400	86,08	1	
25	450	400	78,77	1	
26	450	400	100,33	1	
8	615	550	50,87	1	
10	615	550	43,78	1	
12	615	550	52,05	1	
14	615	550	51,33	1	
16	615	550	54,09	1	
18	600	550	64,37	1	
20	600	550	79,02	1	
22	600	550	77,21	1	

**1223** Quatropius (SDS+)

> Ref. 1217/3



∅ mm	L mm	
5,00	110	1
6,00	115	1
8,00	115	1
6,00	165	1
8,00	165	1
10,00	165	1
12,00	165	1
TOTAL		7
€		77,70



**BROCAS PARA PARED  
FORETS BÉTON / MASONRY DRILL-BITS**

**1226 Compaqplus (SDS+)**



Ref. 1226

Ref. 1226/1

Ø mm	L mm	l mm	€	clip	€	pack
5	115	50	7,42	1	6,68	5
6	115	50	7,42	1	6,68	5
6,5	115	50	9,65	1		
7	110	50	10,12	1		
8	115	50	9,65	1	8,68	5
10	115	50	11,29	1	10,17	5
5	165	100	8,85	1	7,97	5
6	165	100	8,11	1	7,30	5
6,5	165	100	10,55	1		
7	165	100	11,08	1		
8	165	100	9,75	1	8,78	5
10	165	100	11,45	1	10,30	5
12	165	100	13,78	1	12,40	5
14	165	100	20,25	1	18,22	5
6	215	150	13,83	1	12,46	5
7	215	150	12,88	1		
8	215	150	11,61	1	10,45	5
10	215	150	13,67	1	12,31	5
12	215	150	16,11	1	14,50	5
14	215	150	23,00	1	20,70	5
16	215	150	32,50	1		
6	315	250	15,32	1		
8	315	250	21,36	1		
10	315	250	21,50	1		
12	315	250	25,00	1		
14	315	250	28,30	1		
16	315	250	37,80	1		
8	465	400	33,23	1		
10	465	400	34,10	1		
12	465	400	36,41	1		
14	465	400	43,20	1		
16	465	400	58,78	1		
18	450	400	74,62	1		
20	450	400	73,41	1		
22	450	400	115,86	1		
24	450	400	129,53	1		
25	450	400	132,13	1		
28	450	400	147,18	1		
30	450	400	157,30	1		
16	600	550	68,32	1		
18	600	550	96,73	1		
20	600	550	156,77	1		
22	600	550	156,77	1		
25	600	550	193,45	1		
16	1000	950	165,73	1		
18	1000	950	194,99	1		
20	1000	950	223,66	1		
22	1000	950	236,86	1		
25	1000	950	269,24	1		

**APLICACIONES  
APPLICATIONS**



**Hormigón armado  
Béton armé  
Reinforced concrete**



**Granito  
Granit  
Granite**



**Hormigón  
Béton  
Concrete**



**Ladrillo  
Brique  
Brick**

**Características  
Caractéristiques  
Features**



**Mango  
SDS+  
Queue SDS+  
SDS+ shank**



**Percusión  
y rotación  
Percussion  
et rotation  
Percussion  
and rotation**



**PGM**

**1226 Compaqplus (SDS+)**

> Ref. 1217/2



Ø mm	L mm	
5,00	115	1
6,00	115	1
8,00	115	1
6,00	165	1
8,00	165	1
10,00	165	1
12,00	165	1
TOTAL		7
€		86,01

**1222 Performax (SDS MAX)**

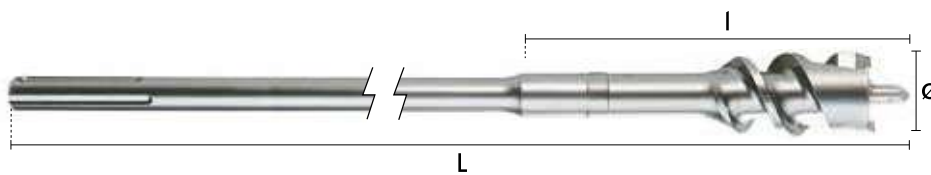

Ref. 1222

Ø mm	L mm	l mm	€	
45,00	590	450	419,34	1
55,00	590	450	491,27	1
65,00	590	450	558,97	1
80,00	590	450	693,83	1
45,00	990	850	459,70	1
55,00	990	850	495,07	1
65,00	990	850	610,62	1
80,00	990	850	743,10	1

**APLICACIONES**  
APPLICATIONS



**Hormigón armado**  
Béton armé  
Reinforced concrete



**Granito**  
Granit  
Granite



**Ladrillo hormigón**  
Brique béton  
Concrete brick



**Ladrillo**  
Brique  
Brick

**Características**  
Caractéristiques  
Features



**Mango SDS MAX**  
Queue SDS MAX  
SDS Max shank



**Punta perforadora**  
Pointe perforatrice  
Drilling tip



**Percusión y rotación**  
Percussion et rotation  
Percussion and rotation

**BROCAS PARA PARED  
FORETS BÉTON / MASONRY DRILL-BITS**



**APLICACIONES  
APPLICATIONS**



**Hormigón armado  
Béton armé  
Reinforced concrete**



**Granito  
Granit  
Granite**



**Ladrillo hormigón  
Brique béton  
Concrete brick**



**Ladrillo  
Brique  
Brick**

**Características  
Caractéristiques  
Features**



**Mango  
SDS MAX  
Queue  
SDS MAX  
SDS Max  
shank**



**Punta  
4 cortes  
Pointe  
4 dents  
4-cut tip**



**Percusión  
y rotación  
Percussion  
et rotation  
Percussion  
and rotation**



**2 cortes  
2 pointe  
2 cut tip**

**1203 > Fastermax (SDS MAX)**



**Ref. 1203**

Ø mm	L mm	l mm	€	
12,00	340	200	69,93	1
14,00	340	200	83,87	1
15,00	340	200	93,68	1
16,00	340	200	93,68	1
18,00	340	200	96,35	1
20,00	340	200	96,35	1
22,00	340	200	99,04	1
24,00	340	200	101,22	1
25,00	340	200	104,65	1
26,00	340	200	111,50	1
28,00	340	200	120,68	1
30,00	340	200	132,73	1
32,00	340	200	132,74	1
12,00	540	360	81,20	1
14,00	540	360	96,11	1
15,00	540	360	97,33	1
16,00	540	360	102,46	1
18,00	540	360	105,13	1
20,00	540	360	110,79	1
22,00	540	360	115,67	1
24,00	540	360	135,49	1
25,00	540	360	129,11	1
26,00	540	360	137,93	1
28,00	540	360	137,93	1
30,00	540	360	153,56	1
32,00	540	360	165,33	1
35,00	540	360	186,81	1
38,00	540	360	247,47	1
40,00	540	360	314,96	1
45,00	540	360	410,38	1
16,00	690	550	132,04	1
18,00	690	550	132,04	1
20,00	690	550	152,10	1
22,00	690	550	152,10	1
25,00	690	550	168,82	1
28,00	690	550	179,73	1
32,00	690	550	203,11	1
35,00	690	550	203,00	1
38,00	690	550	313,74	1

**BROCAS PARA PARED**  
**FORETS BÉTON / MASONRY DRILL-BITS**

**1203** **Fastermax (SDS MAX)**



Ref. 1203

Ø mm	L mm	l mm	€	
40,00	690	550	352,96	1
16,00	920	780	148,77	1
18,00	920	780	150,41	1
20,00	920	780	164,65	1
22,00	920	780	164,65	1
25,00	920	780	188,04	1
28,00	920	780	250,74	1
32,00	920	780	250,74	1
35,00	920	780	321,82	1
36,00*	920	780	327,68	1
40,00	920	780	380,15	1
20,00	1320	1170	266,70	1
25,00	1320	1170	360,48	1
28,00	1320	1170	425,63	1
32,00	1320	1170	489,44	1
36,00*	1320	1170	641,87	1
40,00	1320	1170	941,21	1

(Hasta fin de existencias / Jusqu'à épuisement des stocks / While supplies last)

**APLICACIONES**  
**APPLICATIONS**



**Hormigón armado**  
**Béton armé**  
**Reinforced concrete**



**Granito**  
**Granit**  
**Granite**



**Ladrillo hormigón**  
**Brique béton**  
**Concrete brick**



**Ladrillo**  
**Brique**  
**Brick**

**Características**  
**Caractéristiques**  
**Features**



**Mango SDS MAX**  
**Queue SDS MAX**  
**SDS Max shank**



**Punta 4 cortes**  
**Pointe 4 dents**  
**4-cut tip**



**Percusión y rotación**  
**Percussion et rotation**  
**Percussion and rotation**

**BROCAS PARA PARED  
FORETS BÉTON / MASONRY DRILL-BITS**



**APLICACIONES  
APPLICATIONS**



Gres / Grès / Stoneware



Hormigón  
Béton  
Concrete



Ladrillo  
Brique  
Brick



Acero <80Kg  
Acier <80Kg  
Steel <80Kg



Maderas blandas  
Bois tendre  
Softwoods



Plástico  
Plastique  
Plastic

**Características  
Caractéristiques  
Features**



Punta  
2 cortes  
Pointe 2 dents  
2-cut tip



Fresado  
tipo S  
Fraisage type S  
S-type milling



Percusión  
y rotación  
Percussion  
et rotation  
Percussion  
and rotation

**1207 Óptima**

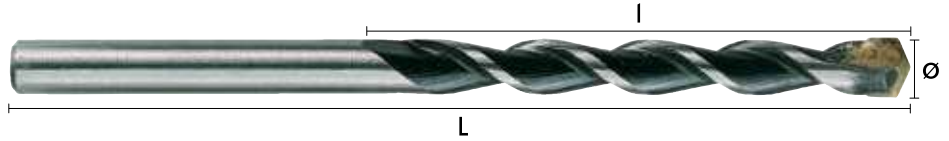

Ø mm	L mm	l mm	tubo		pack	
			Ref. 1207	Ref. 1207/1	Ref. 1207	Ref. 1207/1
3,00	70	40	5,09	1	4,63	10
4,00	75	40	4,91	1	4,46	10
5,00	85	50	5,50	1	5,00	10
6,00	100	60	5,58	1	5,05	10
7,00	100	60	5,90	1		
8,00	120	80	6,37	1	5,77	10
9,00	120	80	7,35	1		
10,00	120	80	8,48	1	7,71	5
11,00	150	90	10,56	1		
12,00	150	90	12,01	1	10,91	5
14,00	150	90	16,03	1		
5,00	150	90	9,85	1		
6,00	150	90	10,39	1		
8,00	200	150	11,02	1		
10,00	200	150	13,00	1		
12,00	200	150	13,58	1		

Estuches / Coffrets / Cases

> Ref. 8128/4



Ø mm	€	pack
3,00 - 4,00 - 5,00 - 6,00 - 7,00 - 8,00 - 9,00 - 10,00	53,80	8

> Ref. 8130/4



Ø mm	€	pack
4,00 - 5,00 - 6,00 - 8,00 - 10,00	34,52	5

# BROCAS PARA PARED FORETS BÉTON / MASONRY DRILL-BITS

1225 Perfecta

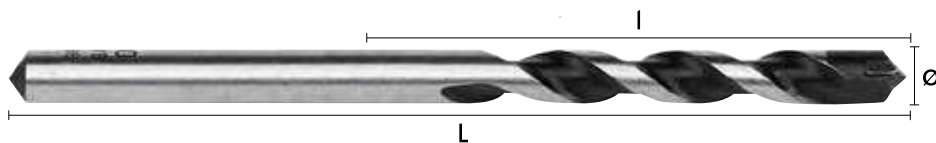

Ø mm	L mm	l mm	tubo		pack	
			Ref. 1225	Ref. 1225/1	Ref. 1225	Ref. 1225/1
3,00	70	35	3,05	1	2,79	10
3,50*	70	35	3,13	1		
4,00	75	40	3,05	1	2,79	10
5,00	85	50	3,13	1	2,85	10
6,00	100	60	3,60	1	3,29	10
7,00	100	60	4,09	1		
8,00	120	70	4,47	1	4,09	10
9,00	120	70	5,14	1		
10,00	120	80	6,02	1	5,46	5
11,00*	150	80	8,08	1		
12,00	150	80	8,32	1	7,56	5
13,00*	150	80	10,59	1		
14,00	150	80	13,04	1		
15,00*	160	80	15,13	1		
16,00	160	80	16,83	1		
18,00*	160	80	22,32	1		
20,00	160	80	26,68	1		
6,00	150	80	4,74	1		
8,00*	150	80	5,34	1		
8,00	250	170	7,54	1		
10,00	250	170	9,51	1		
12,00*	250	170	12,84	1		
14,00*	250	170	23,36	1		

(Hasta fin de existencias / Jusqu'à épuisement des stocks / While supplies last)

Estuches / Coffrets / Cases

> Ref. 8130/5

Ø mm	€	pack
400 500 600 800 1000	24,33	5



## APLICACIONES APPLICATIONS



Granito / Granit / Granite



Hormigón  
Béton  
Concrete



Ladrillo  
hormigón  
Brique béton  
Concrete brick



Ladrillo  
Brique  
Brick



Cerámica  
Céramique  
Ceramic



Gres  
Grès  
Stoneware



Mármol  
Marbre  
Marble

## Características Caractéristiques Features



Punta  
2 cortes  
Pointe 2 dents  
2-cut tip



Fresado  
tipo U  
Fraisage type U  
U-type milling



Percusión  
y rotación  
Percussion  
et rotation  
Percussion  
and rotation



Punta soldada  
a 1100°  
Pointe soudée à 1100°  
Tip soldered at 1100°

**BROCAS PARA PARED  
FORETS BÉTON / MASONRY DRILL-BITS**

**1208 Diamond**



**APLICACIONES  
APPLICATIONS**



**Hormigón  
Béton  
Concrete**



**Ladrillo  
hormigón  
Brique béton  
Concrete brick**



**Ladrillo  
Brique  
Brick**



**Gres  
Grès  
Stoneware**



**Cerámica  
Céramique  
Ceramic**



**Mármol  
Marbre  
Marble**

**Características  
Caractéristiques  
Features**



**Punta  
2 cortes  
Pointe 2 dents  
2-cut tip**



**Fresado  
tipo U  
Fraisage type U  
U-type milling**



**Percusión  
y rotación  
Percussion  
et rotation  
Percussion  
and rotation**



**Punta soldada  
a 1100°  
Pointe soudée à 1100°  
Tip soldered at 1100°**



tubo



pack

Ref. 1208

Ref. 1208/1

Ø mm	L mm	l mm	Ref. 1208		Ref. 1208/1	
			€	pack	€	pack
3,00	70	40	2,42	1	2,19	10
3,50	70	40	2,29	1		
4,00	75	40	2,37	1	2,16	10
4,50	80	50	2,29	1		
5,00	85	50	2,37	1	2,16	10
5,50	85	50	2,42	1		
6,00	100	60	2,65	1	2,41	10
6,50	100	60	3,04	1		
7,00	100	60	2,95	1		
8,00	120	80	3,18	1	2,88	10
9,00	120	80	3,64	1		
10,00	120	80	4,58	1	4,16	5
11,00	150	90	5,95	1		
12,00	150	90	6,65	1	6,04	5
13,00	150	90	8,16	1		
14,00	150	90	10,06	1		
15,00	160	100	11,62	1		
16,00	160	100	12,94	1		
18,00	160	100	17,18	1		
20,00	160	100	20,53	1		
22,00	160	100	23,59	1		
25,00	160	100	27,10	1		
5,00	150	90	3,29	1		
5,50	150	90	3,68	1		
6,00	150	90	3,64	1		
6,50	150	90	5,30	1		
7,00	150	90	4,21	1		
8,00	150	90	4,97	1		
10,00	150	90	6,46	1		
8,00	200	150	5,91	1		
10,00	200	150	7,46	1		
12,00	200	150	7,53	1		
10,00	300	250	7,37	1		
12,00	300	250	9,87	1		
14,00	300	250	17,98	1		
8,00	400	350	12,77	1		
10,00	400	350	13,36	1		
12,00	400	350	15,84	1		
14,00	400	350	20,30	1		
16,00	400	350	23,87	1		
18,00 *	400	350	26,24	1		
20,00 *	400	350	31,03	1		
22,00 *	400	350	36,71	1		
24,00 *	400	350	43,30	1		
10,00	600	550	18,44	1		
12,00	600	550	18,73	1		
14,00 *	600	550	22,34	1		
16,00 *	600	550	26,80	1		
18,00 *	600	550	31,44	1		
20,00 *	600	550	40,00	1		

(Hasta fin de existencias / Jusqu'à épuisement des stocks / While supplies last)

**1208** Diamond

Estuches / Coffrets / Cases

> Ref. 8128/3



∅ mm	€	
3,00 - 4,00 - 5,00 - 6,00 - 7,00 - 8,00 - 9,00 - 10,00	28,78	8

> Ref. 8130/3



∅ mm	€	
4,00 - 5,00 - 6,00 - 8,00 - 10,00	18,73	5

**APLICACIONES**  
**APPLICATIONS**



**Hormigón**  
**Béton**  
**Concrete**



**Ladrillo hormigón**  
**Brique béton**  
**Concrete brick**



**Ladrillo**  
**Brique**  
**Brick**



**Gres**  
**Grès**  
**Stoneware**



**Cerámica**  
**Céramique**  
**Ceramic**



**Mármol**  
**Marbre**  
**Marble**

**Características**  
**Caractéristiques**  
**Features**



**Punta 2 cortes**  
**Pointe 2 dents**  
**2-cut tip**



**Fresado tipo U**  
**Fraisage type U**  
**U-type milling**



**Percusión y rotación**  
**Percussion et rotation**  
**Percussion and rotation**



**Punta soldada a 1100°**  
**Pointe soudée à 1100°**  
**Tip soldered at 1100°**



**BROCAS ENGANCHE HEXAGONAL 1/4"**  
**FORETS EMMANCHEMENT HEXAGONAL 1/4"**  
**DRILL-BITS WITH HEXAGON SHANK 1/4"**

**1502** **DIAMOND Hex.**

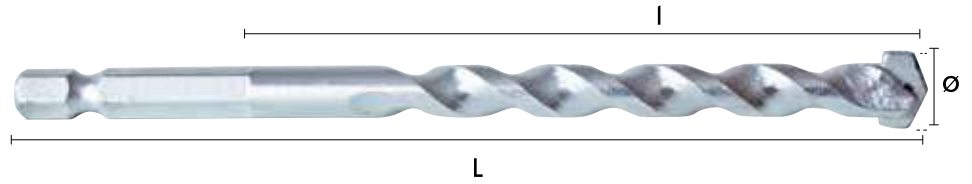

**APLICACIONES**  
**APPLICATIONS**



**Hormigón**  
**Béton**  
**Concrete**



**Ladrillo hormigón**  
**Brique béton**  
**Concrete brick**



**Ladrillo**  
**Brique**  
**Brick**



**Gres**  
**Grès**  
**Stoneware**



**Cerámica**  
**Céramique**  
**Ceramic**



**Mármol**  
**Marbre**  
**Marble**

**Características**  
**Caractéristiques**  
**Features**



**Punta 2 cortes**  
**Pointe 2 dents**  
**2-cut tip**



**Fresado tipo U**  
**Fraisage type U**  
**U-type milling**



**Percusión y rotación**  
**Percussion et rotation**  
**Percussion and rotation**



**Punta soldada a 1100°**  
**Pointe soudée à 1100°**  
**Tip soldered at 1100°**



**Mango hexagonal 1/4"**  
**Queue hexagonale 1/4"**  
**Hexagonal shank 1/4"**



**Cambio rápido**  
**Change rapide**  
**Quick change**



**Ref. 1502**

Ø mm	L mm	l mm	€	
3,00	60	35	2,53	1
4,00	75	35	2,71	1
5,00	85	35	3,39	1
6,00	100	50	3,72	1
7,00	100	50	4,06	1
8,00	120	70	4,40	1
9,00	120	70	5,09	1
10,00	120	70	5,60	1
12,00	150	80	6,76	1

**BROCAS PARA PARED**  
**FORETS BÉTON / MASONRY DRILL-BITS**

**1209 Marmolit**



Ref. 1209

Ø mm	L mm	l mm	€	
3,00	60	40	1,06	1
3,50	60	40	1,18	1
4,00	75	40	0,92	1
5,00	85	50	0,96	1
5,50*	85	50	1,18	1
6,00	100	60	1,06	1
7,00	100	60	1,27	1
8,00	120	80	1,48	1
9,00	120	80	1,79	1
10,00	120	80	2,20	1
11,00	150	90	2,64	1
12,00	150	90	2,87	1
13,00	150	90	4,25	1
14,00	150	90	4,72	1
15,00	150	100	5,69	1
16,00	150	100	6,22	1
18,00	160	100	7,78	1
20,00	160	100	10,64	1
24,00*	160	100	17,48	1
25,00*	160	100	18,31	1
5,00	150	90	2,49	1
6,00	150	90	2,67	1
7,00*	150	90	2,84	1
6,00	200	150	3,74	1
7,00*	200	150	3,98	1
8,00	200	150	4,42	1
9,00*	200	150	4,73	1
10,00	200	150	4,91	1
11,00*	200	150	4,96	1
12,00	200	150	5,07	1
6,00	300	250	4,97	1
7,00*	300	250	5,41	1
8,00	300	250	5,47	1
9,00*	300	250	5,55	1
10,00	300	250	5,60	1
12,00	300	250	6,47	1
13,00	300	250	7,84	1
14,00	300	250	7,96	1
16,00	300	250	11,26	1
18,00	300	250	12,99	1
20,00	300	250	17,51	1
6,00	400	350	5,78	1
7,00*	400	350	6,14	1
8,00	400	350	6,22	1

(Hasta fin de existencias / Jusqu'à épuisement des stocks / While supplies last)

**APLICACIONES**  
**APPLICATIONS**



**Ladrillo / Brique / Brick**



**Cerámica**  
Céramique  
Ceramic



**Ladrillo hormigón**  
Brique béton  
Concrete brick



**Hormigón**  
Béton  
Concrete

**Características**  
**Caractéristiques**  
**Features**



**Punta 2 cortes**  
Pointe 2 dents  
2-cut tip



**Percusión y rotación**  
Percussion et rotation  
Percussion and rotation

**BROCAS PARA PARED  
FORETS BÉTON / MASONRY DRILL-BITS**



**APLICACIONES  
APPLICATIONS**



**Ladrillo / Brique / Brick**



**Cerámica  
Céramique  
Ceramic**



**Ladrillo  
hormigón  
Brique béton  
Concrete brick**



**Hormigón  
Béton  
Concrete**

**Características  
Caractéristiques  
Features**



**Punta  
2 cortes  
Pointe 2 dents  
2-cut tip**



**Percusión  
y rotación  
Percussion  
et rotation  
Percussion  
and rotation**

**1209 Marmolit**



**Ref. 1209**

Ø mm	L mm	l mm	€	
10,00	400	350	6,84	1
12,00	400	350	7,84	1
14,00	400	350	8,60	1
15,00	400	350	9,83	1
16,00	400	350	12,07	1
18,00	400	350	14,31	1
20,00	400	350	19,73	1
22,00 *	400	350	35,69	1
8,00	600	550	8,49	1
10,00	600	550	9,25	1
12,00	600	550	9,99	1
14,00	600	550	11,48	1
16,00	600	550	15,67	1
18,00	600	550	17,33	1
20,00	600	550	25,32	1
22,00 *	600	550	38,38	1
28,00 *	600	550	95,41	1

(Hasta fin de existencias / Jusqu'à épuisement des stocks / While supplies last)

Estuches / Coffrets / Cases

> Ref. 8128/2



> Ref. 8130/2



Ø mm	€	
3,00 - 4,00 - 5,00 - 6,00 - 7,00 - 8,00 - 9,00 - 10,00	15,41	8

Ø mm	€	
4,00 - 5,00 - 6,00 - 8,00 - 10,00	10,31	5

**1227** **Porceline**



Ref. 1227

Ø mm	L mm	€	
5,00	55	21,92	1
6,00	55	24,61	1
7,00	55	26,02	1
8,00	55	27,06	1
10,00	55	29,30	1
12,00	55	31,25	1
15,00	55	33,85	1
20,00	55	39,17	1
25,00	55	47,40	1
35,00	55	49,40	1

> Ref. 1227/1 **Dispensador de agua** / Réservoir d'eau / Water dispenser



Ø mm	€	
5,00 - 10,00	3,56	1
12,00 - 25,00	3,56	1

> Ref. 8138



Ref.	Ø mm	€	
8138	5,00 - 6,00 - 7,00 - 8,00 - 10,00 + dispensador	134,66	1

**APLICACIONES**  
**APPLICATIONS**



**Porcelanato**  
Céramique dur / Hard tile



**Gres**  
Grès  
Stoneware



**Cerámica**  
Céramique  
Ceramic



**Granito**  
Granit  
Granite



**Vidrio**  
Verre  
Glass

**Características**  
Caractéristiques  
Features



**Diamante**  
Diamant  
Diamond



**Rotación**  
Rotation  
Rotation



**1** Refrigerar de manera abundante la zona a perforar.  
Refrroidir abondamment la zone à perforeur.  
Cool the area to be drilled.



**2** Comenzar a perforar en un ángulo de 45° hasta realizar una pequeña muesca.  
Commencer à perforeur à un angle de 45° jusqu'à obtenir une petite encoche.  
Start to drill at a 45° angle until you make a small notch.



**3** Perforar de forma perpendicular hasta realizar el orificio.  
Perforeur perpendiculairement jusqu'à réalisation de l'orifice.  
Drill at a right angle until you make a hole.



**APLICACIONES  
APPLICATIONS**



**Porcelanato**  
Céramique dur / Hard tile



**Gres**  
Grès  
Stoneware



**Cerámica**  
Céramique  
Ceramic

**Características  
Caractéristiques  
Features**



**Rotación**  
Rotation  
Rotation



**APLICACIONES  
APPLICATIONS**



**Vidrio / Verre / Glass**



**Cerámica**  
Céramique  
Ceramic



**Gres**  
Grès  
Stoneware

**Características  
Caractéristiques  
Features**



**Punta Ojiva**  
Pointe Ogive  
Pointed tip



**Rotación**  
Rotation  
Rotation

**1228 Porceline Widia**

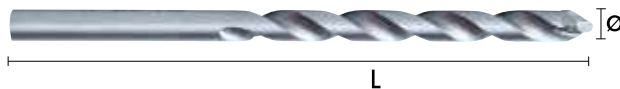

Ref. 1228

Ø mm	L mm	l mm	€	
3,00*	85	40	17,08	1
4,00	85	50	17,08	1
5,00	85	50	18,06	1
6,00	100	65	18,89	1
7,00*	125	75	21,62	1
8,00	126	75	23,43	1
9,00*	150	90	28,40	1
10,00	150	90	28,40	1

(Hasta fin de existencias / Jusqu'à épuisement des stocks / While supplies last)

**1212 Vidrio**



Ref. 1212

Ø mm	L mm	€	
3,00	58	5,42	1
4,00	64	5,58	1
5,00	70	6,14	1
6,00	76	6,64	1
7,00	77	7,89	1
8,00	83	8,31	1
9,00	84	11,23	1
10,00	90	11,23	1
12,00	97	16,95	1

**7121** **SDS+**





Ref. 7121

Ø mm	z	€	
25,00	4	65,87	1
30,00	6	70,62	1
35,00	6	75,76	1
40,00	6	82,55	1
50,00	6	94,67	1
65,00	6	95,54	1
68,00	6	107,37	1
82,00	6	137,15	1
90,00	6	161,47	1
100,00	6	183,04	1
112,00	6	220,72	1

Accesorios / Accessoires / Accessories

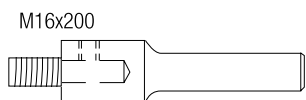
> Ref. 7122 Mango hexagonal / Queue hexagonale / Hexagonal shank



L mm	€	
78	36,50	1
220	51,21	1
370	62,26	1

> Ref. 7123 Mango SDS+ / Queue SDS+ / SDS+ Shank



L mm	€	
105	42,90	1
220	57,44	1
370	68,27	1

> Ref. 7124 Broca de centrar Ø 8 / Foret de centrage Ø 8 / Centre drill-bit Ø 8



L mm	€	
120	9,25	1

> Ref. 7153 Mango broca / Queue foret / Drill-bit shank



L mm	€	
175	79,92	1
340	104,54	1
440	121,94	1

**APLICACIONES**  
**APPLICATIONS**



Hormigón / Béton / Concrete



Granito  
Granit  
Granite



Ladrillo  
hormigón  
Brique béton  
Concrete brick



Ladrillo  
Brique  
Brick

**Características**  
**Caractéristiques**  
**Features**



Mango  
SDS+  
Queue SDS+  
SDS+ shank



Punta  
Dientes MD  
Pointe  
Dents de MD  
MD tooth tip



Percusión  
y rotación  
Percussion  
et rotation  
Percussion  
and rotation



**APLICACIONES  
APPLICATIONS**



**Hormigón / Béton / Concrete**



**Granito  
Granit  
Granite**



**Ladrillo  
hormigón  
Brique béton  
Concrete brick**



**Ladrillo  
Brique  
Brick**

**Características  
Caractéristiques  
Features**



**Mango  
SDS MAX**  
Queue  
SDS MAX  
SDS Max  
shank



**Mango  
estriado**  
Queue  
canalée  
Ribbed  
shank



**Mango SW 19**  
Queue SW 19  
SW 19 shank



**Mango SW 13**  
Queue SW 13  
SW 13 shank



**Punta  
Dientes MD**  
Pointe  
Dents de MD  
MD tooth tip



**Percusión  
y rotación**  
Percussion  
et rotation  
Percussion  
and rotation

**7125 SDS MAX**



**Ref. 7125**

Ø mm	Z	€	
45,00	4	155,24	1
50,00	6	185,61	1
55,00	6	202,48	1
68,00	6	215,96	1
82,00	6	307,09	1
90,00	6	357,71	1
100,00	6	388,07	1
125,00	6	438,70	1
150,00	6	573,69	1

**Accesorios / Accessoires / Accessories**

**> Ref. 7126 Mango SDS MAX / Queue SDS MAX / SDS MAX Shank**

L mm	€	
200	94,67	1
460	111,59	1

**> Ref. 7127 Mango estriado / Queue canalée / Ribbed shank**

L mm	€	
200*	94,67	1
460*	111,59	1

(Hasta fin de existencias / Jusqu'à épuisement des stocks / While supplies last)

**> Ref. 7128 SW 19**

L mm	€	
200*	94,67	1
460*	111,59	1

(Hasta fin de existencias / Jusqu'à épuisement des stocks / While supplies last)

**> Ref. 7129 SW 13**

L mm	€	
200*	94,67	1
460*	111,59	1

(Hasta fin de existencias / Jusqu'à épuisement des stocks / While supplies last)

**> Ref. 7130 Broca de centrar Ø 11 / Foret de centrage Ø 11 / Centre drill-bit Ø 11**

L mm	€	
135	19,80	1

# CORONAS PARED SCIES-TRÉPAN BÉTON / CORE BITS

## 7154 Tungsteno

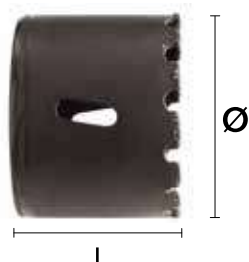

Ref. 7154

Ø mm	L mm	€	Icon
16,00	40	13,44	1
19,00	40	14,08	1
20,00	40	14,73	1
22,00	40	16,04	1
25,00	40	17,63	1
29,00	40	19,07	1
30,00 *	40	19,00	1
32,00	40	19,83	1
35,00	40	19,94	1
38,00	40	21,36	1
44,00	40	21,60	1
48,00	40	22,13	1
51,00	40	22,43	1
54,00	40	24,14	1
57,00	40	24,93	1
60,00	40	25,22	1
64,00	40	25,51	1
70,00	40	27,30	1
76,00	40	28,94	1
83,00	40	29,37	1
86,00	40	31,19	1
95,00	40	39,71	1
102,00	40	35,38	1

(Hasta fin de existencias / Jusqu'à épuisement des stocks / While supplies last)

### Accesorios / Accessoires / Accessories

#### > Ref. 7160 Broca de Centrar / Foret de centrage / Centre drill-bit

Ø mm	€	Icon
8,00	8,35	1

#### > Ref. 7161 Husillo hexagonal / Arbre hexagonal / Hexagonal spindle

Rosca / Filetage / Thread	Ø mm	€	Icon
1/2 UNF	16,00-30,00	20,34	1
5/8 UNF	31,00-114,00	37,71	1

### APLICACIONES APPLICATIONS



Gres / Grès / Stoneware



Porcelanato  
Céramique dur  
Hard tile



Fibra de vidrio  
Fibre de verre  
Fibreglass



Ladrillo  
Brique  
Brick

### Características Caractéristiques Features



Taladro manual 20 mm  
Perceuse manuel 20 mm  
Manual drill 20 mm





**APLICACIONES  
APPLICATIONS**



**Hormigón / Béton / Concrete**



**Granito  
Granit  
Granite**



**Ladrillo  
hormigón  
Brique béton  
Concrete brick**



**Ladrillo  
Brique  
Brick**

**Características  
Caractéristiques  
Features**



**Mango  
SDS+  
Queue SDS+  
SDS+ shank**



**Percusión  
Percussion  
Percussion**

**1401** **SDS+**

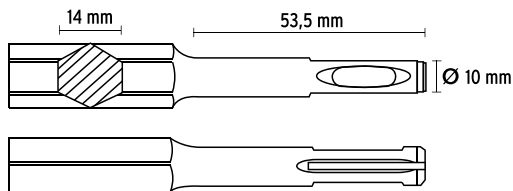

	L mm	p gr	TG mm		clip		pack	
					Ref. 1401	Ref. 1401/1	€	€
001	250	270	20		12,19	1	11,62	5
002	250	260	-		12,19	1	11,62	5
005	250	350	22		23,86	1	-	-
003	250	330	40		20,88	1	-	-
006	250	520	22		79,96	1	-	-
011	260	260	40		26,22	1	-	-
007	250	270	20		14,00	1	-	-
008	250	270	-		14,00	1	-	-
009	250		40		24,55	1	-	-
	250		60		27,23	1	-	-

Elu, Felisati, Hilti, Kress, Makita, Aeg, Atlas Copco, Black & Decker, Bosch, Dewalt, Metabo.

1405 SDS MAX

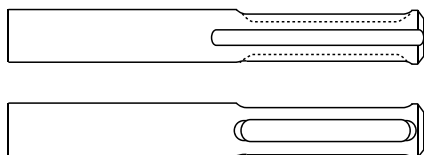

APLICACIONES  
 APPLICATIONS



Hormigón / Béton / Concrete



Granito  
 Granit  
 Granite



Ladrillo  
 hormigón  
 Brique béton  
 Concrete brick



Ladrillo  
 Brique  
 Brick

Características  
 Caractéristiques  
 Features



Mango  
 SDS MAX  
 Queue  
 SDS MAX  
 SDS Max  
 shank



Percusión  
 Percussion  
 Percussion

	L mm	P gr	TG mm	clip		pack	
				Ref. 1405	Ref. 1405/1		
				€	€	€	€
001	280 400 600	500 730 1130	25 25 25	17,28 17,23 22,99	1 1 1	16,41	5
002	280 400 600	480 710 1110	- - -	17,28 17,23 22,99	1 1 1	16,41	5
003	400	790	50	34,93	1	-	-
004	300	780	80	38,79	1	-	-
005	300	570	26	35,80	1	-	-
006	380	940	35	131,54	1	-	-
007	400	730	25	19,81	1	-	-
008	400	710	-	19,81	1	-	-
009	350	790	50	40,85	1	-	-
010	400	790	-	23,10	1	-	-
011	300	710	50	36,70	1	-	-

Elu, Hilti, Hitachi, Kango, Makita, Aeg, Atlas Copco, Bosch, Dewalt, Metabo, Milwaukee, Spit.

**BROCAS PARA MADERA  
FORETS À BOIS / WOOD DRILL-BITS**



**APLICACIONES  
APPLICATIONS**



**Maderas blandas**  
Bois tendre / Softwoods



**Aglomerado**  
Stratifié  
Plywood

**Características  
Caractéristiques  
Features**



**3 puntas  
madera**  
3 dents bois  
3-tip wood



**Cromo vanadio**  
Chrome vanadium  
Chromium Vanadium

**1301 3P ST**



**Ref. 1301**

Ø mm	L mm	I mm	€	
3,00	60	30	0,66	1
4,00	70	40	0,72	1
5,00	85	45	0,78	1
6,00	90	50	1,08	1
7,00	105	60	1,23	1
8,00	110	65	1,47	1
9,00	115	70	1,72	1
10,00	120	70	1,87	1
11,00	130	75	2,23	1
12,00	140	85	2,43	1
13,00	150	95	2,46	1
14,00	150	95	2,63	1
15,00	160	100	2,88	1
16,00	160	105	3,47	1
18,00	180	125	4,57	1
20,00	200	130	5,63	1
6,00	300	150	2,80	1
8,00	300	150	3,50	1
10,00	300	150	4,07	1
12,00	300	150	5,05	1
14,00	300	150	6,29	1
16,00	300	150	8,45	1
18,00	300	150	11,09	1
20,00	300	150	12,89	1

Estuches / Coffrets / Cases

> Ref. 8131/2



Ø mm	€	
3,00 - 4,00 - 5,00 - 6,00 - 7,00 - 8,00 - 9,00 - 10,00	13,28	8

> Ref. 8132/2



Ø mm	€	
4,00 - 5,00 - 6,00 - 8,00 - 10,00	8,97	5

# BROCAS PARA MADERA FORETS À BOIS / WOOD DRILL-BITS

Estuches / Coffrets / Cases

> Ref. 8133 Estuche Brocas Combinadas (HSS,MARMOLIT,3P)



Ø mm HSS	Ø mm Muros / Murs / Walls Marmolit	Ø mm Madera / Bois / Wood 3 P	€	
4 - 5 - 6 - 8	4 - 5 - 6 - 8	-	14,28	8

> Ref. 8134 Estuche Brocas Combinadas (HSS,MARMOLIT,3P)



Ø mm HSS	Ø mm Muros / Murs / Walls Marmolit	Ø mm Madera / Bois / Wood 3 P	€	
4 - 6 - 8	4 - 6 - 8	4 - 6 - 8	17,12	9

> Ref. 8136 Estuche Brocas Combinadas (HSS, MARMOLIT,3P)



Ø mm HSS	Ø mm Muros / Murs / Walls Marmolit	Ø mm Madera / Bois / Wood 3 P	€	
5 - 6 - 8	5 - 6 - 8	5 - 6 - 8	17,51	9

**BROCAS PARA MADERA  
FORETS À BOIS / WOOD DRILL-BITS**



**APLICACIONES  
APPLICATIONS**



**Aglomerado  
Stratifié  
Plywood**

**Maderas blandas  
Bois tendre / Softwoods**

**Características  
Caractéristiques  
Features**



**3 puntas  
madera  
3 dents bois  
3-tip wood**



**Cromo vanadio  
Chrome vanadium  
Chromium Vanadium**



**Mango  
hexagonal 1/4"  
Queue  
hexagonale 1/4"  
Hexagonal  
shank 1/4"**



**Cambio rápido  
Change rapide  
Quick change**

**1503 ST Hex.**



**Ref. 1503**

Ø mm	L mm	l mm	€	
2,00	70	24	1,02	1
3,00	82	33	0,85	1
4,00	96	43	0,93	1
5,00	106	52	1,19	1
6,00	113	57	1,27	1
7,00	129	69	1,43	1
8,00	117	75	1,70	1
9,00	125	81	1,78	1
10,00	133	87	2,04	1
11,00	142	94	2,20	1
12,00	151	101	2,46	1

**1302** **3P Pro**



Ref. 1302

Ø mm	L mm	l mm	€	
3,00	60	30	1,25	1
4,00	75	43	1,33	1
5,00	85	52	1,60	1
6,00	100	63	2,04	1
7,00	100	60	2,30	1
8,00	120	75	2,63	1
9,00	120	81	3,47	1
10,00	120	70	3,98	1
11,00	150	75	4,59	1
12,00	150	85	5,34	1
13,00	150	95	5,62	1
14,00	150	95	8,50	1
15,00	160	100	12,68	1
16,00	160	105	12,01	1
18,00	160	125	21,19	1
20,00	160	130	25,98	1
6,00	300	160	7,26	1
8,00	300	160	9,99	1
10,00	300	160	12,60	1
12,00	300	160	16,15	1
14,00	300	160	20,77	1
16,00	300	160	26,71	1
18,00 *	300	160	33,47	1
20,00 *	300	160	41,88	1

(Hasta fin de existencias / Jusqu'à épuisement des stocks / While supplies last)

Estuches / Coffrets / Cases

> Ref. 8131/1



Ø mm	€	
3,00 - 4,00 - 5,00 - 6,00 - 7,00 - 8,00 - 9,00 - 10,00	22,38	8

> Ref. 8132/1



Ø mm	€	
4,00 - 5,00 - 6,00 - 8,00 - 10,00	14,63	5

**APLICACIONES**  
**APPLICATIONS**



**Maderas duras**  
Bois dur / Hardwoods



**Contrachapado**  
Contreplaqués  
Plywood



**Aglomerado**  
Stratifié  
Plywood



**Maderas blandas**  
Bois tendre  
Softwoods

**Características**  
**Caractéristiques**  
**Features**



**3 puntas**  
**madera**  
3 dents bois  
3-tip wood



**Rotación**  
Rotation  
Rotation

**HSS**

**Acero rápido**  
Acier rapide  
High speed steel



**APLICACIONES  
APPLICATIONS**



**Maderas blandas**  
Bois tendre / Softwoods



**Aglomerado  
Stratifié**  
Plywood

**Características  
Caractéristiques  
Features**



**Punta pala PRO**  
Pointe plate PRO  
PRO spade tip



**Rotación**  
Rotation  
Rotation



**Mango hexagonal 1/4"**  
Queue hexagonale 1/4"  
Hexagonal shank 1/4"



**Cambio rápido**  
Change rapide  
Quick change

**1303**

**Pala Standard  
Plat Standard / Standard Spade**



**Ref. 1303**

Ø mm	L mm	€	
6,00	152	1,47	1
8,00	152	1,71	1
10,00	152	1,81	1
12,00	152	1,88	1
14,00	152	2,04	1
15,00	152	2,35	1
16,00	152	2,35	1
18,00	152	2,51	1
19,00	152	2,67	1
20,00	152	2,67	1
22,00	152	3,30	1
24,00	152	3,60	1
25,00	152	3,76	1
26,00	152	4,07	1
28,00	152	4,38	1
30,00	152	4,69	1
32,00	152	4,93	1
33,00	152	5,15	1
34,00	152	5,70	1
35,00	152	5,95	1
36,00	152	6,20	1
38,00	152	6,43	1
40,00	152	6,73	1

**1304**

**Pala Pro**  
 Plat Pro / Pro Spade



Ref. 1304

Ø mm	L mm	€	
6,00	152	2,26	1
8,00	152	2,40	1
10,00	152	2,65	1
12,00	152	2,81	1
14,00	152	2,90	1
16,00	152	3,34	1
18,00	152	3,50	1
19,00 *	152	3,58	1
20,00	152	3,71	1
22,00	152	4,41	1
24,00	152	4,57	1
25,00	152	4,92	1
26,00	152	5,13	1
28,00	152	5,38	1
30,00	152	5,85	1
32,00	152	6,16	1
33,00 *	152	6,88	1
34,00	152	6,88	1
35,00	152	7,26	1
36,00	152	7,55	1
38,00	152	7,88	1
40,00	152	8,40	1

(Hasta fin de existencias / Jusqu'à épuisement des stocks / While supplies last)

**APLICACIONES**  
**APPLICATIONS**



**Maderas duras**  
 Bois dur / Hardwoods



**Contrachapado**  
 Contreplaqués  
 Plywood



**Aglomerado**  
 Stratifié  
 Plywood



**Maderas blandas**  
 Bois tendre  
 Softwoods

**Características**  
**Caractéristiques**  
**Features**



**Punta pala ST**  
 Pointe plate ST  
 ST spade tip



**Rotación**  
 Rotation  
 Rotation



**Mango hexagonal 1/4"**  
 Queue hexagonale 1/4"  
 Hexagonal shank 1/4"



**Cambio rápido**  
 Change rapide  
 Quick change





**APLICACIONES**  
**APPLICATIONS**



**Maderas duras**  
Bois dur / Hardwoods



**Contrachapado**  
Contreplaqués  
Plywood



**Maderas blandas**  
Bois tendre  
Softwoods

**Características**  
**Caractéristiques**  
**Features**



**Rotación**  
Rotation  
Rotation

**1305** **Pala Extensible**  
**Plat Extensible / Expansion Spade**

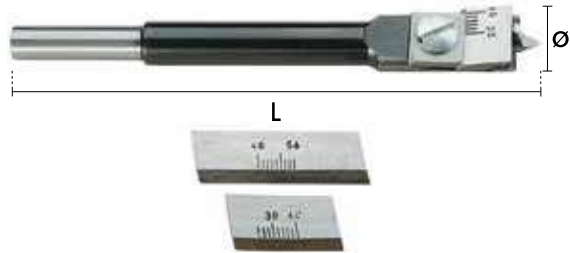

**Ref. 1305**

Ø mm	L mm	€	
15,00 - 45,00	120	32,26	1
25,00 - 75,00	155	40,30	1

**1320** **Alargador**  
**Adaptateur / Extension Piece**



**Ref. 1320**

Ø mm	L mm	€	
12,00	300	13,98	1

**1306 Lewis**

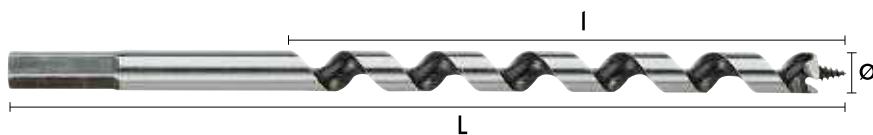

Ref. 1306

Ø mm	L mm	l mm	€	
6,00	235	160	9,88	1
8,00	235	160	9,88	1
10,00	235	160	10,25	1
12,00	235	160	11,66	1
14,00	235	160	12,32	1
16,00	235	160	13,79	1
18,00	235	160	15,79	1
20,00	235	160	17,04	1
22,00	235	160	18,60	1
24,00	235	160	21,13	1
26,00	235	160	23,85	1
28,00	235	160	27,48	1
30,00	235	160	31,61	1
32,00	235	160	35,74	1
8,00	450	350	22,25	1
10,00	450	350	22,25	1
12,00	450	350	23,62	1
14,00	450	350	25,99	1
16,00	450	350	29,78	1
18,00	450	350	32,09	1
20,00	450	350	34,68	1
22,00	450	350	37,69	1
24,00	450	350	41,23	1
26,00	450	350	49,06	1
28,00	450	350	56,29	1
30,00	450	350	67,25	1
32,00	450	350	82,51	1

**APLICACIONES**  
**APPLICATIONS**



**Maderas duras**  
Bois dur / Hardwoods



**Contrachapado**  
Contreplaqués  
Plywood



**Maderas blandas**  
Bois tendre  
Softwoods

**Características**  
**Caractéristiques**  
**Features**



**Punta tipo Lewis**  
Pointe type Lewis  
Lewis-type tip



**Rotación**  
Rotation  
Rotation

**BROCAS PARA MADERA  
FORETS À BOIS / WOOD DRILL-BITS**



**APLICACIONES  
APPLICATIONS**



**Maderas duras**  
Bois dur / Hardwoods



**Contrachapado**  
Contreplaqués  
Plywood

**Características  
Caractéristiques  
Features**



**Punta tipo Lewis**  
Pointe type Lewis  
Lewis-type tip



**Mango SDS+**  
Queue SDS+  
SDS+ shank



**Rotación**  
Rotation  
Rotation

**1321 Lewis (SDS+)**

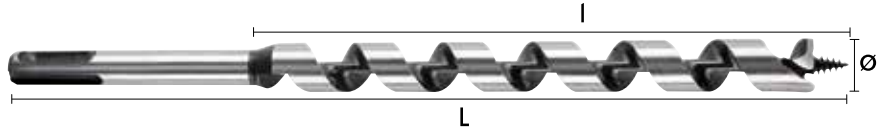

**Ref. 1321**

Ø mm	L mm	l mm	€	
6,00	200	100	19,30	1
8,00	200	100	19,30	1
10,00	235	160	19,55	1
12,00	235	160	21,36	1
14,00	235	160	24,09	1
16,00	235	160	27,16	1
18,00	235	160	30,42	1
20,00	235	160	32,09	1
22,00	235	160	36,52	1
24,00	235	160	38,88	1
10,00	400	320	26,26	1
12,00	400	320	27,63	1
14,00	400	320	30,42	1
16,00	400	320	33,75	1
18,00	400	320	36,81	1
20,00	400	320	39,59	1
22,00	400	320	43,33	1
24,00	400	320	46,93	1

**1307**

**Encofrar**  
Coffrage / Shuttering



Ref. 1307

Ø mm	L mm	l mm	€	
6,00	400	370	10,62	1
8,00	400	370	10,76	1
10,00	400	370	12,82	1
12,00	400	370	16,60	1
14,00	400	370	18,39	1
16,00	400	370	21,39	1
18,00	400	370	26,14	1
20,00	400	370	35,29	1
22,00	400	370	47,13	1
24,00	400	370	55,16	1
26,00	400	370	60,73	1
28,00	400	370	66,19	1
30,00	400	370	69,84	1
8,00	600	570	11,44	1
10,00	600	570	13,33	1
12,00	600	570	17,43	1
14,00	600	570	19,06	1
16,00	600	570	22,06	1
18,00	600	570	26,81	1
20,00	600	570	35,82	1
22,00	600	570	47,82	1
24,00	600	570	55,94	1
26,00	600	570	61,53	1
28,00	600	570	67,01	1
30,00	600	570	70,65	1
8,00	800	770	15,51	1
10,00	800	770	17,27	1
12,00	800	770	21,07	1
14,00	800	770	24,14	1
16,00	800	770	28,21	1
18,00	800	770	33,59	1
20,00	800	770	42,52	1
22,00	800	770	55,45	1
24,00	800	770	63,56	1
26,00	800	770	69,07	1
28,00	800	770	74,48	1
30,00	800	770	78,12	1
8,00	1000	970	16,19	1
10,00	1000	970	18,22	1
12,00	1000	970	22,00	1
14,00	1000	970	25,09	1
16,00	1000	970	35,75	1
18,00	1000	970	35,75	1
20,00	1000	970	44,65	1
22,00	1000	970	57,73	1
24,00	1000	970	65,97	1
26,00	1000	970	71,22	1
28,00	1000	970	74,56	1
30,00	1000	970	80,42	1

**APLICACIONES**  
APPLICATIONS



**Encofrados**  
Coffrages / Shuttering

**Características**  
Caractéristiques  
Features



**Rotación**  
Rotation  
Rotation

**BROCAS PARA MADERA  
FORETS À BOIS / WOOD DRILL-BITS**



**APLICACIONES  
APPLICATIONS**



**Encofrados  
Coffrages / Shuttering**

**Características  
Caractéristiques  
Features**



**Mango  
SDS+  
Queue SDS+  
SDS+ shank**



**Rotación  
Rotation  
Rotation**

**1318**

**Encofrar (SDS+)  
Coffrage / Shuttering**

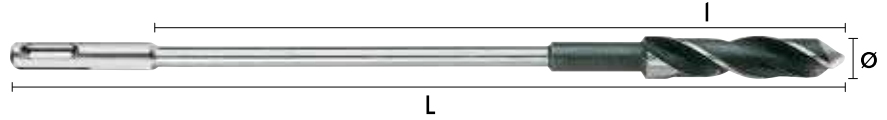

funda

**Ref. 1318**

Ø mm	L mm	l mm	€	
10,00	400	370	27,97	1
12,00	400	370	31,48	1
14,00	400	370	39,02	1
16,00	400	370	48,91	1
18,00	400	370	64,95	1
20,00	400	370	72,89	1
22,00	400	370	86,27	1
24,00	400	370	91,84	1
26,00	400	370	103,34	1
28,00	400	370	111,99	1
30,00	400	370	126,64	1
32,00	400	370	132,25	1
35,00	400	370	143,81	1
10,00	600	570	29,26	1
12,00	600	570	30,13	1
14,00	600	570	41,93	1
16,00	600	570	51,78	1
18,00	600	570	67,81	1
20,00	600	570	75,76	1
22,00	600	570	83,16	1
24,00	600	570	97,56	1
26,00	600	570	109,14	1
28,00	600	570	117,77	1
30,00	600	570	132,25	1
32,00	600	570	138,03	1
35,00	600	570	149,60	1

**1308**

**Avellanador**

Fraise à trou et à chanfreiner / Countersink bit



Ref. 1308

Ø mm	d mm	L mm	€	
12,00	3	20	7,20	1
12,00	4	20	7,20	1
12,00	5	20	7,20	1
12,00	6	20	7,20	1
16,00	3	21	9,67	1
16,00	4	21	9,67	1
16,00	5	21	9,67	1
16,00	6	25	9,67	1
16,00	8	25	9,67	1

**1314**

**Broca Forstner**

Mèche Forstner / Cup drill-bit Forstner



Ø mm	l mm	€		Ø mm	l mm	€	
8	90	10,65	1	36	90	32,81	1
10	90	10,94	1	38	90	35,73	1
12	90	11,67	1	40	90	38,65	1
14	90	12,40	1	42	90	42,29	1
15	90	13,13	1	45	90	44,48	1
16	90	13,56	1	48	90	46,67	1
18	90	13,71	1	50	90	48,85	1
20	90	14,29	1	52	90	62,71	1
22	90	15,02	1	54	90	64,17	1
24	90	17,21	1	58	90	80,21	1
25	90	18,23	1	60	160	84,58	1
26	90	18,96	1	64	160	90,42	1
28	90	20,42	1	68	160	102,08	1
30	90	23,33	1	70	160	116,67	1
32	90	26,25	1	72	160	109,38	1
34	90	28,44	1	76	160	116,67	1
35	90	29,17	1	80	160	122,50	1

**APLICACIONES**  
**APPLICATIONS**



**Maderas duras**  
Bois dur / Hardwoods



**Contrachapado**  
Contreplaqués  
Plywood



**Maderas blandas**  
Bois tendre  
Softwoods

**Características**  
**Caractéristiques**  
**Features**



**Ángulo 90°**  
Angle 90°  
Angle 90°



**Rotación**  
Rotation  
Rotation

**APLICACIONES**  
**APPLICATIONS**



**Maderas duras**  
Bois dur / Hardwoods



**Contrachapado**  
Contreplaqués  
Plywood



**Maderas blandas**  
Bois tendre  
Softwoods

**Características**  
**Caractéristiques**  
**Features**



**Rotación**  
Rotation  
Rotation



**APLICACIONES  
APPLICATIONS**



**Maderas duras**  
Bois dur / Hardwoods



**Contrachapado**  
Contreplaqués  
Plywood



**Maderas blandas**  
Bois tendre  
Softwoods

**Características  
Caractéristiques  
Features**



**Rotación**  
Rotation  
Rotation



**APLICACIONES  
APPLICATIONS**



**Maderas duras**  
Bois dur / Hardwoods



**Contrachapado**  
Contreplaqués  
Plywood



**Maderas blandas**  
Bois tendre  
Softwoods

**Características  
Caractéristiques  
Features**



**1309 Cazoleta T1**  
Mèche type Forstner T1 / Cup drill-bit T1

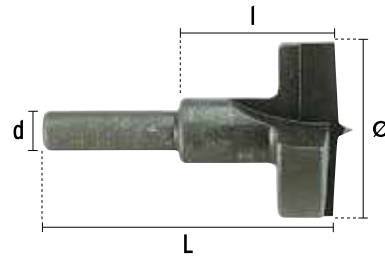

Ref. 1309

Ø mm	d mm	L mm	l mm	€	
26,00	8	57	25	24,36	1
30,00	8	57	25	24,36	1
35,00	8	57	25	24,36	1

**1310 Cazoleta T2**  
Mèche type Forstner T2 / Cup drill-bit T2



Ref. 1310

Ø mm	d mm	L mm	l mm	€	
20,00	8	57	25	39,22	1
26,00	8	57	25	39,22	1
30,00	8	57	25	39,22	1
35,00	8	57	25	39,22	1

(Hasta fin de existencias / Jusqu'à épuisement des stocks / While supplies last)

**1311 Cazoleta T3**  
Mèche type Forstner T3 / Cup drill-bit T3

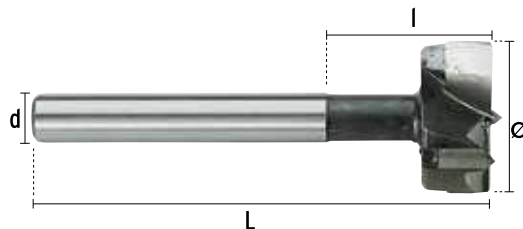

Ref. 1311

Ø mm	d mm	L mm	l mm	€	
20,00	10	90	30	71,52	1
26,00	10	90	30	89,20	1
30,00	10	90	30	83,39	1
35,00	10	90	30	92,02	1
40,00	10	90	30	109,84	1

(Hasta fin de existencias / Jusqu'à épuisement des stocks / While supplies last)

**7149** Multi



Ref. 7149

Ø mm	z	€	
25,00	3	62,58	1
30,00	3	63,95	1
35,00	3	65,94	1
40,00	3	68,79	1
45,00	3	79,86	1
50,00	3	86,07	1
55,00	3	86,07	1
58,00	5	89,43	1
60,00	5	89,43	1
63,00	5	89,43	1
65,00	5	89,88	1
68,00	5	89,88	1
70,00	5	122,63	1
74,00	5	123,68	1
80,00	5	130,02	1
85,00	5	145,92	1
105,00	6	170,65	1

(Hasta fin de existencias / Jusqu'à épuisement des stocks / While supplies last)

Accesorios / Accessoires / Accessories

> Ref. 7152 Broca de centrar Ø 7,2 - 8 / Foret de centrage Ø 7,2 - 8 / Centre drill-bit Ø 7,2 - 8

L mm	€	
109	5,53	1
120	7,32	1

> Ref. 7151 MANGO SDS+ / Queue SDS+ / SDS+ Shank

L mm	€	
105	42,90	1
220	57,44	1
370	68,27	1

> Ref. 7150 Mango Hexagonal / Queue hexagonale / Hexagonal shank

L mm	€	
78	36,50	1
220	51,21	1
370	62,26	1

**APLICACIONES**  
**APPLICATIONS**



**Maderas duras**  
**Bois dur / Hardwoods**



**Contrachapado**  
**Contreplaqués**  
**Plywood**



**Acero <80Kg**  
**Acier <80Kg**  
**Steel <80Kg**



**Aluminio**  
**Aluminium**



**Acero Inox**  
**Acier Inox**  
**Stainless steel**



**Maderas blandas**  
**Bois tendre**  
**Softwoods**



**Estratificado**  
**Stratifié**  
**Plywood**



**PVC**

**Características**  
**Caractéristiques**  
**Features**



**Mango SDS+**  
**Queue SDS+**  
**SDS+ shank**



**Punta Dientes MD**  
**Pointe Dents de MD**  
**MD tooth tip**



**Rotación**  
**Rotation**  
**Rotation**





**APLICACIONES**  
APPLICATIONS

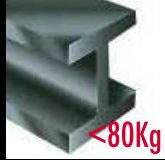

**Acero <80Kg**  
Acier <80Kg / Steel <80Kg



**Fundición**  
Fonte  
Cast Iron

**Características**  
Caractéristiques  
Features



**Serie corta**  
Série courte  
Short series



**Punta a 118°**  
Pointe à 118°  
118° Tip



**Convencional**  
Normal  
Conventional



**Convencional**  
Normal  
Conventional



**Espiral a 30°**  
Spiral à 30°  
30° Spiral

**8163** Rectificada (HSS DIN 338N)



Ø mm	L mm	l mm	tubo		pack	
			Ref. 8163	Ref. 1101	Ref. 8163	Ref. 1101
1,00	34	12	4,09	3	1,14	10
1,50	40	18	3,60	3	0,96	10
2,00	49	24	3,50	3	0,94	10
2,50	57	30	3,50	3	0,94	10
3,00	61	33	2,36	2	0,83	10
3,25	65	36	2,75	2	1,04	10
3,50	70	39	2,75	2	1,04	10
4,00	75	43	1,74	1	1,07	10
4,25	75	43	2,06	1	1,38	10
4,50	80	47	2,06	1	1,38	10
5,00	86	52	2,04	1	1,36	10
5,25	86	52	2,43	1	1,73	10
5,50	93	57	2,43	1	1,73	10
6,00	93	57	2,50	1	1,82	10
6,50	101	63	3,02	1	2,34	10
7,00	109	69	3,37	1	2,69	10
7,50	109	69	3,73	1	3,03	10
8,00	117	75	3,86	1	3,17	10
8,50	117	75	4,67	1	3,98	10
9,00	125	81	5,01	1	4,36	10
10,00	133	87	5,66	1	4,97	5
11,00	142	94	7,50	1	6,82	5
12,00	151	101	8,68	1	8,01	5
13,00	151	101	10,54	1	9,86	5

**Rectificada (HSS DIN 338N)**

Estuches / Coffrets / Cases

> Ref. 8123/2\*

Ø mm	€	Icono
1,00-1,50-2,00-2,50-3,00-3,50-4,00-4,50-5,00-5,50 6,00-6,50-7,00-7,50-8,00-8,50-9,00-9,50-10,00	45,91	19

(Hasta fin de existencias / Jusqu'à épuisement des stocks / While supplies last)



> Ref. 8124/2

Ø mm	€	Icono
1,00-2,00-3,00-4,00-5,00-6,00-7,00-8,00-9,00-10,00	25,51	10



> Ref. 8125/2

Ø mm	€	Icono
2,00-2,50-3,00-3,50-4,00-4,50-5,00 5,50-6,00-6,50-7,00-7,50-8,00	24,69	13



> Ref. 8126/2

Ø mm	€	Icono
2,00-3,00-4,00-5,00-6,00-8,00	12,48	6



**APLICACIONES**  
**APPLICATIONS**

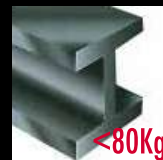

**Acero <80Kg**  
**Acier <80Kg / Steel <80Kg**



**Fundición**  
**Fonte**  
**Cast Iron**

**Características**  
**Caractéristiques**  
**Features**



**Serie corta**  
**Série courte**  
**Short series**



**Punta a 118°**  
**Pointe à 118°**  
**118° Tip**



**Convencional**  
**Normal**  
**Conventional**



**Convencional**  
**Normal**  
**Conventional**



**Espiral a 30°**  
**Spiral à 30°**  
**30° Spiral**

**BROCAS PARA METAL  
FORETS À MÉTAUX / METAL DRILL-BITS**



**APLICACIONES  
APPLICATIONS**



**Acero <80Kg**  
Acier <80Kg / Steel <80Kg



**Fundición**  
Fonte  
Cast Iron

**Características  
Caractéristiques  
Features**



**Serie corta**  
Série courte  
Short series



**Punta a 118°**  
Pointe à 118°  
118° Tip



**Convencional**  
Normal  
Conventional



**Convencional**  
Normal  
Conventional



**Espiral a 30°**  
Spiral à 30°  
30° Spiral



**Cambio rápido**  
Change rapide  
Quick change



**Mango hexagonal 1/4"**  
Queue hexagonale 1/4"  
Hexagonal shank 1/4"

**1501 HSS Hex.**

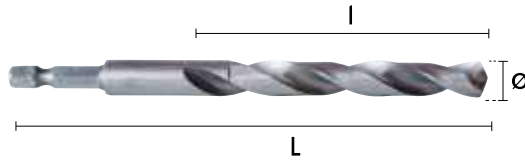

**Ref. 1501**

Ø mm	L mm	l mm	€	
3,00	61	33	3,72	1
4,00	75	43	4,09	1
5,00	86	52	4,27	1
6,00	93	57	4,60	1
7,00	109	69	4,74	1
8,00	117	75	5,00	1
9,00	125	81	5,07	1
10,00	133	87	6,38	1

**1154 Speedplus (HSS DIN 338NSP)**



Ø mm	L mm	l mm	tubo		pack	
			Ref. 1154	Ref. 1158	Ref. 1154	Ref. 1158
1,00	34	12	4,38	3	1,25	10
1,50	40	18	3,87	3	1,08	10
2,00	49	24	3,74	3	1,03	10
2,50	57	30	3,74	3	1,03	10
3,00	61	33	2,49	2	0,93	10
3,25	65	36	2,94	2	1,14	10
3,50	70	39	2,94	2	1,14	10
4,00	75	43	1,80	1	1,18	10
4,25	75	43	2,14	1	1,49	10
4,50	80	47	2,14	1	1,49	10
5,00	86	52	2,14	1	1,49	10
5,25	86	52	2,53	1	1,90	10
5,50	93	57	2,53	1	1,90	10
6,00	93	57	2,65	1	2,02	10
6,50	101	63	3,18	1	2,57	10
7,00	109	69	3,59	1	2,97	10
7,50	109	69	4,01	1	3,37	10
8,00	117	75	4,12	1	3,49	10
8,50	117	75	5,06	1	4,41	10
9,00	125	81	5,42	1	4,81	10
10,00	133	87	6,13	1	5,48	5
11,00	142	94	8,17	1	7,54	5
12,00	151	101	9,50	1	8,85	5
13,00	151	101	11,51	1	10,85	5

Estuches / Coffrets / Cases

> Ref. 8124/5



Ø mm	€	pack
1,00-2,00-3,00-4,00-5,00-6,00-7,00-8,00-9,00-10,00	28,85	10

> Ref. 8126/5



Ø mm	€	pack
2,00-3,00-4,00-5,00-6,00-8,00	14,39	6



**APLICACIONES**  
**APPLICATIONS**



**Acero <80Kg**  
Acier <80Kg / Steel <80Kg



**Fundición**  
Fonte  
Cast Iron

**Características**  
Caractéristiques  
Features



**Serie corta**  
Série courte  
Short series



**Punta a 118°**  
Pointe à 118°  
118° Tip



**Split Point**



**Espiral a 30°**  
Spiral à 30°  
30° Spiral



**Corrección de labios**  
Correction de lèvres  
Lip correction

**BROCAS PARA METAL  
FORETS À MÉTAUX / METAL DRILL-BITS**



**APLICACIONES  
APPLICATIONS**

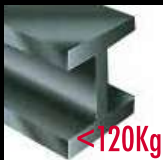

**Acero <120Kg**  
Acier <120Kg / Steel <120Kg



**Acero inox**  
Acier inox  
Stainless steel

**Características  
Caractéristiques  
Features**



**Serie corta**  
Série courte  
Short series



**Punta a 135°**  
Pointe à 135°  
135° Tip



**Split Point**



**Espiral a 30°**  
Spiral à 30°  
30° Spiral



**Corrección de labios**  
Correction de lèvres  
Lip correction

**8164 > Cobalt (HSSCO DIN 338N)**



Ø mm	L mm	l mm	Ref. 8164		Ref. 1105	
			€		€	
1,00	34	12	6,18	3	1,86	10
1,50	40	18	5,69	3	1,70	10
2,00	49	24	5,84	3	1,74	10
2,50	57	30	6,18	3	1,86	10
3,00	61	33	3,69	2	1,55	10
3,25	65	36	4,76	2	2,07	10
3,50	70	39	4,70	2	2,05	10
4,00	75	43	2,65	1	2,01	10
4,25	75	43	2,99	1	2,35	10
4,50	80	47	3,10	1	2,46	10
5,00	86	52	2,99	1	2,35	10
5,25	86	52	3,58	1	2,95	10
5,50	93	57	4,37	1	3,72	10
6,00	93	57	3,82	1	3,18	10
6,50	101	63	4,74	1	4,13	10
7,00	109	69	4,96	1	4,36	10
7,50	109	69	5,27	1	4,63	10
8,00	117	75	6,38	1	5,79	10
8,50	117	75	6,33	1	5,68	10
9,00	125	81	7,83	1	7,19	10
10,00	133	87	9,67	1	9,07	5
11,00	142	94	13,95	1	13,31	5
12,00	151	101	17,35	1	16,72	5
13,00	151	101	23,88	1	23,24	5

Estuches / Coffrets / Cases

> Ref. 8124/3



Ø mm	€	
1,00-2,00-3,00-4,00-5,00-6,00-7,00-8,00-9,00-10,00	45,20	10

> Ref. 8126/3



Ø mm	€	
2,00 - 3,00 - 4,00 - 5,00 - 6,00 - 8,00	21,06	6

**8169** Cobalt W (HSS DIN 338W)



Ø mm	L mm	l mm	tubo		pack	
			Ref. 8169	Ref. 1187	Ref. 8169	Ref. 1187
3,00	61	33	6,19	2	2,60	10
3,25	65	36	7,35	2	3,19	10
3,50	70	39	7,20	2	3,14	10
4,00	75	43	4,48	1	3,41	10
4,25	75	43	4,83	1	3,78	10
4,50	80	47	4,77	1	3,78	10
5,00	86	52	5,18	1	4,06	10
5,25	86	52	5,78	1	4,75	10
5,50	93	57	6,03	1	5,14	10
6,00	93	57	6,56	1	5,47	10
6,50	101	63	7,35	1	6,40	10
7,00	109	69	7,95	1	6,97	10
7,50	109	69	8,44	1	7,42	10
8,00	117	75	9,56	1	8,68	10
8,50	117	75	10,11	1	9,06	10
9,00	125	81	12,57	1	11,54	10
10,00	133	87	14,05	1	13,18	5
11,00	142	94	20,55	1	19,62	5
12,00	151	101	25,12	1	24,20	5
13,00	151	101	28,10	1	27,34	5



**APLICACIONES**  
**APPLICATIONS**



**Acero inox**  
Acier inox / Stainless steel



**Aluminio**  
Aluminium  
Aluminium

**Características**  
Caractéristiques  
Features



**Serie corta**  
Série courte  
Short series



**Punta a 135°**  
Pointe à 135°  
135° Tip



**Split Point**



**Corrección de labios**  
Correction de lèvres  
Lip correction



**Espiral a 40°**  
Spiral à 40°  
40° Spiral





**APLICACIONES**  
APPLICATIONS

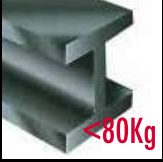

**Acero <80Kg**  
Acier <80Kg / Steel <80Kg



**Fundición**  
Fonte  
Cast Iron

**Características**  
Caractéristiques  
Features



**Punta a 118°**  
Pointe à 118°  
118°Tip



**Convencional**  
Normal  
Conventional



**2 Cortes**  
2 Coupes  
2 Cuts



**Convencional**  
Normal  
Conventional

**5105** Broca Escalonada (HSS)



Ø mm	Grad. mm	L mm	d mm	€	
4,00 - 12,00	1	69	6	43,47	1
4,00 - 12,00	2	69	6	45,41	1
4,00 - 20,00	2	75	8	58,66	1
6,00 - 30,00	2	95	10	89,09	1

> Ref. 5140



Ø mm	€	
4-12, 4-20, 6-30	218,07	3

> Ref. 5141



Ø mm	€	
4-20, 6-30	170,50	2

**5101 Broca Avellanadora**



∅ mm	L mm	d mm	€	
3,00 - 14,00	62	6	21,24	1
6,00 - 20,00	70	6	29,65	1
16,00 - 30,00	78	10	60,34	1
26,00 - 40,00	86	12	127,72	1

> Ref. 5138



∅ mm	€	
3-14, 6-20, 16-30	125,40	3



**APLICACIONES**  
**APPLICATIONS**

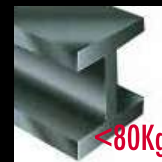

**Acero <80Kg**  
 Acier <80Kg / Steel <80Kg



**Fundición**  
 Fonte  
 Cast Iron

**Características**  
 Caractéristiques  
 Features



**Punta a 118°**  
 Pointe à 118°  
 118°Tip



**Convencional**  
 Normal  
 Conventional



**2 Cortes**  
 2 Coupes  
 2 Cuts



**Convencional**  
 Normal  
 Conventional





**APLICACIONES  
APPLICATIONS**

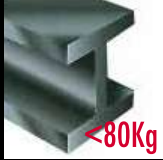

**Acero <80Kg**  
Acier <80Kg / Steel <80Kg



**Acero inox**  
Acier inox  
Stainless steel



**Aluminio**  
Aluminium  
Aluminium



**PVC**

**Características  
Caractéristiques  
Features**



**Dentado variable 4/6 tpi**  
Denture variable 4/6 tpi  
Variable touch pitch 4/6 tpi



**Ángulo corte neutro 0°**  
Angle coupe neutre 0°  
Neutral cut angle 0°



**8% CO**



**Taladro manual 20 mm**  
Percapce manuel 20 mm  
Manual drill 20 mm

**7111 Bimetal M42**



Ø mm	P.G.	L mm	Ref. 7111	Ref. 8157	1
			€	blister €	
14,00	-	40	14,43	14,96	1
16,00	9	40	14,43	14,96	1
17,00	-	40	14,43	14,96	1
19,00	11	40	14,43	14,96	1
20,00	-	40	14,43	14,96	1
21,00	11	40	14,43	14,96	1
22,00	16	40	14,43	14,96	1
24,00	-	40	14,43	14,96	1
25,00	-	40	15,32	15,87	1
27,00	-	40	16,23	16,77	1
29,00	21	40	16,23	16,77	1
30,00	-	40	16,23	16,77	1
32,00	-	40	16,23	16,77	1
33,00	-	40	16,23	16,77	1
35,00	-	40	17,26	17,80	1
37,00	29	40	17,26	17,80	1
38,00	-	40	17,26	17,80	1
40,00	-	40	17,26	17,80	1
41,00	-	40	17,26	17,80	1
43,00	-	40	17,26	17,80	1
44,00	-	40	21,10	21,65	1
46,00	-	40	21,10	21,65	1
48,00	36	40	21,10	21,65	1
50,00	-	40	21,10	21,65	1
51,00	-	40	21,10	21,65	1
52,00	-	40	24,97	25,51	1
54,00	42	40	24,97	25,51	1
56,00	-	40	24,97	25,51	1
57,00	-	40	24,97	25,51	1
59,00	-	40	24,97	25,51	1

**7111 Bimetal M42**



Ø mm	P.G.	L mm	Ref. 7111		Ref. 8157	
			€	blister €	€	blister €
60,00	-	40	24,97	25,51	1	
64,00	-	40	27,66	28,21	1	
65,00	-	40	27,66	28,21	1	
67,00	-	40	27,66	28,21	1	
68,00	-	40	27,66	28,21	1	
70,00	-	40	27,66	28,21	1	
73,00	-	40	27,66		1	
76,00	-	40	28,26		1	
79,00	-	40	28,26		1	
83,00	-	40	28,26		1	
86,00	-	40	28,26		1	
89,00	-	40	28,26		1	
92,00	-	40	32,74		1	
95,00	-	40	38,04		1	
98,00	-	40	40,27		1	
102,00	-	40	42,32		1	
105,00	-	40	45,62		1	
108,00	-	40	59,92		1	
111,00	-	40	70,82		1	
114,00	-	40	82,64		1	
121,00	-	40	91,81		1	
127,00	-	40	101,80		1	
133,00	-	40	111,90		1	
140,00	-	40	122,00		1	
152,00	-	40	142,43		1	
160,00	-	40	220,13		1	
168,00	-	40	241,92		1	
177,00	-	40	246,40		1	
210,00	-	40	260,42		1	
250,00	-	40	275,25		1	

**APLICACIONES**  
**APPLICATIONS**



**Acero <80Kg**  
**Acier <80Kg / Steel <80Kg**



**Acero inox**  
**Acier inox**  
**Stainless steel**



**Aluminio**  
**Aluminium**  
**Aluminium**



**PVC**

**Características**  
**Caractéristiques**  
**Features**



**Dentado variable 4/6 tpi**  
**Denture variable 4/6 tpi**  
**Variable touch pitch 4/6 tpi**



**Ángulo corte neutro 0°**  
**Angle coupe neutre 0°**  
**Neutral cut angle 0°**



**8% CO**



**Taladro manual 20 mm**  
**Percupe manuel 20 mm**  
**Manual drill 20 mm**

**7110** **Bimetal Dentado Fino M42**  
Denture Fine / Fine Tooth Pitch

**APLICACIONES**  
APPLICATIONS



**Acero <80Kg**  
Acier <80Kg / Steel <80Kg



**Acero inox**  
Acier inox  
Stainless steel



**Aluminio**  
Aluminium  
Aluminium



**PVC**

**Características**  
Caractéristiques  
Features



**Dentado fino 10 tpi**  
Denture fine 10 tpi  
Fine touch pitch 10 tpi



**Ángulo corte neutro 0°**  
Angle coupe neutre 0°  
Neutral cut angle 0°



**8% CO**



**Taladro manual 20 mm**  
Percapce manuel 20 mm  
Manual drill 20 mm



Ø mm	P.G.	L mm	€	
16,00	9	40	14,43	1
19,00	11	40	14,43	1
20,00	-	40	14,43	1
22,00	16	40	14,43	1
25,00	-	40	15,32	1
27,00	-	40	16,23	1
29,00	21	40	16,23	1
30,00	-	40	16,23	1
32,00	-	40	16,23	1
35,00	-	40	17,26	1
38,00	-	40	17,26	1
40,00	-	40	17,26	1
43,00	-	40	17,26	1
46,00	-	40	21,10	1
48,00	36	40	21,10	1
51,00	-	40	21,10	1
54,00	42	40	24,97	1
57,00	-	40	24,97	1
60,00	-	40	24,97	1
68,00	-	40	27,66	1
70,00	-	40	27,66	1
76,00	-	40	28,26	1
83,00	-	40	28,26	1
98,00	-	40	40,27	1
102,00	-	40	42,32	1

**7142** **Bimetal Cambio Rápido M42**  
 Changement Rapide / Quick Change



Ø mm	L mm	€	
19,00	40	17,74	1
20,00	40	17,74	1
22,00	40	17,74	1
25,00	40	18,65	1
29,00	40	19,57	1
32,00	40	19,57	1
35,00	40	20,57	1
38,00	40	20,57	1
41,00	40	20,57	1
44,00	40	20,57	1
48,00	40	24,44	1
51,00	40	24,44	1
54,00	40	28,29	1
57,00	40	28,29	1
60,00	40	28,29	1
64,00	40	30,98	1
68,00	40	30,98	1
70,00	40	30,98	1
76,00	40	31,59	1



**APLICACIONES**  
**APPLICATIONS**



**Acero <80Kg**  
 Acier <80Kg / Steel <80Kg



**Acero inox**  
 Acier inox  
 Stainless steel



**Aluminio**  
 Aluminium  
 Aluminium



**PVC**

**Características**  
 Caractéristiques  
 Features



**Dentado variable 4/6 tpi**  
 Denture variable 4/6 tpi  
 Variable tooth pitch 4/6 tpi

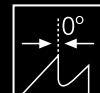

**Ángulo corte neutro 0°**  
 Angle coupe neutre 0°  
 Neutral cut angle 0°



**8% CO**



**Taladro manual 20 mm**  
 Percepe manuel 20 mm  
 Manual drill 20 mm

**7157** **Bimetal TCT**  
Métal Dur / Hard Metal

**APLICACIONES**  
APPLICATIONS



**Acero inox**  
Acier inox / Stainless steel



**Gres**  
Grès  
Stoneware



**Acero <80kg**  
Acier <80kg  
Steel <80kg



**Fibra de vidrio**  
Fibre de verre  
Fibreglass

**Características**  
Caractéristiques  
Features



**Taladro manual 20 mm**  
Percepe manuel 20 mm  
Manual drill 20 mm



**Punta dientes MD**  
Pointe  
Dents de MD  
MD tooth tip



Ø mm	L mm	€	
19,00	40	52,99	1
22,00	40	52,99	1
25,00	40	56,31	1
29,00	40	61,65	1
32,00	40	61,65	1
35,00	40	61,65	1
38,00	40	61,65	1
44,00	40	79,54	1
48,00	40	79,54	1
51,00	40	79,54	1
54,00	40	93,76	1
57,00	40	93,76	1
60,00	40	93,76	1
64,00	40	101,66	1
70,00	40	101,66	1
76,00	40	103,85	1
83,00	40	103,85	1
86,00	40	103,85	1
89,00	40	103,85	1
95,00	40	139,78	1
102,00	40	155,56	1

**Accesorios**  
 Accessoires / Accessories

► Ref. 7112 Husillo eje hexagonal / Arbre axe hexagonal / Hexagonal axis spindle



Rosca Filetage Thread	∅ mm	Hex.	€	
1/2 UNF	14,00-30,00	8,5	15,89	1
1/2 UNF	14,00-30,00	11	15,89	1
5/8 UNF	32,00-250,00	8,5	31,65	1
5/8 UNF	32,00-250,00	11	31,65	1

► Ref. 7112 Husillo eje SDS+ / Arbre axe SDS+ / SDS+ axis spindle



Rosca Filetage Thread	∅ mm	Hex.	€	
1/2 UNF	14,00-30,00	SDS+	15,89	1
5/8 UNF	32,00-250,00	SDS+	31,65	1

► Ref. 7113 Broca de Centrar eje L=85 / Foret de centrage axe L=85 / L=85 axis centre drill-bit



∅ mm	Hex.	€	
14,00 - 250,00	∅ 6,35	4,99	1

► Ref. 7114 Extensión eje L=330 / Extension axe L=330 / L=330 axis extension



∅ mm	Hex.	€	
14,00 - 250,00	11	26,03	1

► Ref. 7143 Husillo cambio rápido eje hexagonal / Arbre changement rapide axe hexagonal / Hexagonal axis quick-change spindle



∅ mm	Hex.	€	
14,00 - 210,00	11	48,70	1

► Ref. 7144 Adaptador / Adaptateur / Adaptor



∅ mm	Hex.	€	
14,00 - 30,00	-	4,14	1
32,00 - 210,00	-	4,63	1

► Ref. 7145 Broca de Centrar eje L=100 / Foret de centrage axe L=100 / L=100 axis centre drill-bit



∅ mm	Hex.	€	
14,00 - 210,00	6,25	4,88	1

► Ref. 7146 Kit cambio rápido husillo+adaptador / Kit changement rapide arbre+adaptateur / Spindle+adaptor quick-change kit



∅ mm	Hex.	€	
-	-	57,46	1

**CORONAS METAL**  
**SCIÉS-TRÉPAN METAUX / METAL HOLE SAWS**



**APLICACIONES**  
**APPLICATIONS**



**Acero inox**  
Acier inox / Stainless steel



**Acero <120kg**  
Acier <120kg  
Steel <120kg



**Aluminio**  
Aluminium  
Aluminium



**PVC**

**Características**  
Caractéristiques  
Features



**Punta dientes MD**  
Pointe  
Dents de MD  
MD tooth tip



**Taladro manual 4 mm**  
Percepe manuel  
4 mm  
Manual drill  
4 mm



**Taladro columna 10 mm**  
Perceuse à  
colonne 10 mm  
Drill press  
10 mm

**7101**

**TCT Metal Duro**  
Métal Dur / Hard Metal

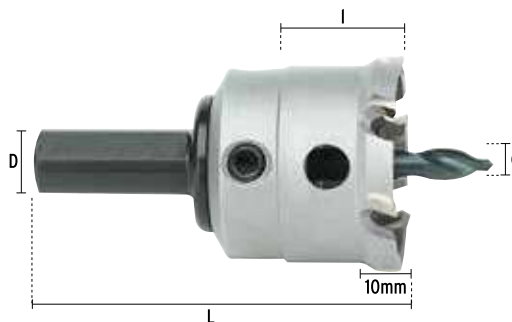

Ø mm	L mm	l mm	Z	d mm	D mm	€	
18,00	67,50	22	4	6	10	90,74	1
19,00	67,50	22	4	6	10	88,61	1
20,00	67,50	22	4	6	10	88,61	1
21,00	67,50	22	4	6	10	91,33	1
22,00	67,50	22	4	6	10	91,33	1
23,00	67,50	22	4	6	10	92,73	1
24,00	67,50	22	4	6	10	92,73	1
25,00	67,50	22	4	6	10	92,73	1
26,00	67,50	22	6	6	10	98,17	1
27,00	67,50	22	6	6	10	99,50	1
28,00	67,50	22	6	6	10	99,50	1
29,00	67,50	22	6	6	10	99,50	1
30,00	67,50	22	6	6	10	99,50	1
31,00	67,50	22	6	6	10	117,27	1
32,00	67,50	22	6	6	10	117,27	1
33,00	67,50	22	6	6	10	121,34	1
34,00	67,50	22	6	6	10	122,68	1
35,00	67,50	22	6	6	10	122,68	1
36,00	67,50	22	6	6	10	124,04	1
38,00	67,50	22	6	6	13	124,04	1
39,00	67,50	22	6	6	13	125,42	1
40,00	67,50	22	6	6	13	125,42	1
41,00	67,50	22	6	6	13	148,59	1
42,00	67,50	22	6	6	13	148,59	1
43,00	67,50	22	6	6	13	152,70	1
44,00	67,50	22	6	6	13	152,70	1
45,00	67,50	22	6	6	13	152,70	1
46,00	67,50	22	6	6	13	158,14	1
48,00	67,50	22	6	6	13	158,14	1
49,00	67,50	22	6	6	13	159,48	1
50,00	67,50	22	6	6	13	159,48	1
51,00	67,50	22	6	6	13	184,03	1
52,00	67,50	22	6	6	13	184,03	1
53,00	67,50	22	6	6	13	185,42	1
55,00	67,50	22	6	6	13	185,42	1
56,00	67,50	22	6	6	13	203,13	1
57,00	67,50	22	6	6	13	203,13	1
58,00	67,50	22	6	6	13	203,13	1
59,00	67,50	22	6	6	13	205,87	1
60,00	67,50	22	6	6	13	205,87	1
61,00	67,50	22	8	8	13	231,75	1
62,00	67,50	22	8	8	13	231,75	1
63,00	67,50	22	8	8	13	231,75	1

**7101**

**TCT Metal Duro**  
 Métal Dur / Hard Metal

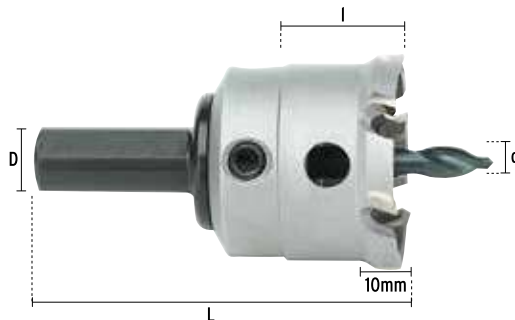

∅ mm	L mm	l mm	Z	d mm	D mm	€	
64,00	67,50	22	8	8	13	231,75	1
65,00	67,50	22	8	8	13	231,75	1
66,00	67,50	22	8	8	13	252,21	1
67,00	67,50	22	8	8	13	252,21	1
68,00	67,50	22	8	8	13	254,94	1
69,00	67,50	22	8	8	13	254,94	1
70,00	67,50	22	8	8	13	254,94	1
75,00	67,50	22	10	8	13	265,84	1
80,00	67,50	22	10	8	13	276,74	1
85,00	67,50	22	10	8	13	279,50	1
90,00	67,50	22	12	8	13	294,47	1
95,00	67,50	22	12	8	13	298,55	1
100,00	67,50	22	12	8	13	306,73	1

**APLICACIONES**  
 APPLICATIONS

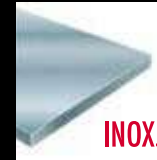

**Acero inox**  
 Acier inox / Stainless steel



**Acero <120kg**  
 Acier <120kg  
 Steel <120kg



**Aluminio**  
 Aluminium  
 Aluminium



**PVC**

**Características**  
 Caractéristiques  
 Features



**Punta  
 dientes MD**  
 Pointe  
 Dents de MD  
 MD tooth tip



**Taladro  
 manual 4 mm**  
 Perceuse manuel  
 4 mm  
 Manual drill  
 4 mm

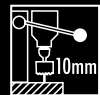

**Taladro  
 columna 10 mm**  
 Perceuse à  
 colonne 10 mm  
 Drill press  
 10 mm

**Accesorios / Accessoires / Accessories**

> **Ref. 7102 Broca de Centrar** / Centre drill-bit / Foret de centrage



∅ mm	Hex.	L mm	€	
18,00 - 60,00	6	50	4,10	1
61,00 - 100,00	8	50	6,02	1

> **Ref. 7103 Cono morse** / Cône morse / Morse taper



∅ mm	Hex.	L mm	€	
61,00 - 100,00	-	-	140,29	1



**7104** **HSS Reafilable**  
HSS Réaffûtable / Resharpenable HSS

**APLICACIONES**  
APPLICATIONS



**Acero inox**  
Acier inox / Stainless steel



**Acero <120kg**  
Acier <120kg  
Steel <120kg



**Aluminio**  
Aluminium  
Aluminium



**PVC**

**Características**  
Caractéristiques  
Features



**HSS**



**Taladro manual 5 mm**  
Perceuse manuel 5 mm  
Manual drill 5 mm



**Taladro columna 8 mm**  
Perceuse à colonne 8 mm  
Drill press 8 mm



Ø mm	L mm	Z	d mm	D mm	€	
10,00	25	6	5	8	18,73	1
11,00	25	6	5	8	19,72	1
12,00	25	6	5	8	20,80	1
13,00	25	6	5	8	21,84	1
14,00	25	6	6	8	22,46	1
15,00	25	6	6	8	23,16	1
16,00	25	6	6	8	23,73	1
17,00	25	6	6	8	24,10	1
18,00	25	8	6	10	24,43	1
19,00	25	8	6	10	24,62	1
20,00	25	8	6	10	24,93	1
21,00	25	8	6	10	26,18	1
22,00	25	8	6	10	27,42	1
23,00	25	8	6	10	28,67	1
24,00	25	8	6	10	29,91	1
25,00	25	10	6	10	31,16	1
26,00	25	10	6	10	32,43	1
27,00	25	10	6	10	33,68	1
28,00	25	10	6	10	34,92	1
29,00	25	10	6	10	36,15	1
30,00	25	10	6	10	37,39	1
31,00	25	10	6	12	38,64	1
32,00	25	12	6	12	39,90	1
33,00	25	12	6	12	41,16	1
34,00	25	12	6	12	42,41	1
35,00	25	12	6	12	43,64	1
36,00	25	12	6	12	44,89	1
37,00	25	12	6	12	46,12	1
38,00	25	12	6	12	47,40	1
39,00	25	14	6	12	48,65	1
40,00	25	14	6	12	49,88	1
41,00	25	14	6	12	51,12	1
42,00	25	14	6	12	52,36	1
43,00	25	14	6	12	53,66	1
44,00	25	14	6	12	54,89	1
45,00	25	14	6	12	56,13	1
46,00	25	16	6	12	57,39	1
47,00	25	16	6	12	58,63	1
48,00	25	16	6	12	59,86	1
49,00	25	16	6	12	61,13	1
50,00	25	16	6	12	62,37	1
51,00	25	18	8	12	79,50	1
52,00	25	18	8	12	81,05	1
53,00	25	18	8	12	82,64	1
54,00	25	18	8	12	84,16	1
55,00	25	18	8	12	85,74	1

(continúa Ref.7104 / suite Réf.7104 / Ref.7104 cont'd)

**7104** **HSS Reafilable**  
HSS Réaffûtable / Resharpenable HSS



Ø mm	L mm	Z	d mm	D mm	€	
56,00	25	18	8	12	87,30	1
57,00	25	18	8	12	88,85	1
58,00	25	22	8	12	90,41	1
59,00	25	22	8	12	92,00	1
60,00	25	22	8	12	93,52	1
61,00	25	22	8	12	107,77	1
62,00	25	22	8	12	109,54	1
63,00	25	22	8	12	111,32	1
64,00	25	22	8	12	113,06	1
65,00	25	22	8	12	114,83	1
66,00	25	22	8	12	116,61	1
67,00	25	22	8	12	118,35	1
68,00	25	24	8	12	120,12	1
69,00	25	24	8	12	121,92	1
70,00	25	24	8	12	123,70	1
75,00	25	24	8	12	132,49	1
80,00	25	24	8	12	141,35	1
85,00	25	26	8	12	163,13	1
90,00	25	26	8	12	171,48	1
95,00	25	28	8	12	181,86	1
100,00	25	28	8	12	192,26	1

**APLICACIONES**  
**APPLICATIONS**

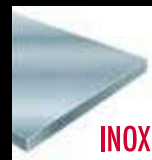

**Acero inox**  
Acier inox / Stainless steel



**Acero <120kg**  
Acier <120kg  
Steel <120kg



**Aluminio**  
Aluminium  
Aluminium



**PVC**

**Características**  
Caractéristiques  
Features



**HSS**



**Taladro manual 5 mm**  
Perceuse manuel 5 mm  
Manual drill 5 mm



**Taladro columna 8 mm**  
Perceuse à colonne 8 mm  
Drill press 8 mm

**Accesorios / Accessoires / Accessories**

**> Ref. 7105 Husillo / Arbore / Spindle**



Ø mm	D mm	Hex.	€	
14,00 - 17,00	8	-	9,57	1
18,00 - 30,00	10	-	9,57	1
31,00 - 50,00	12	-	10,21	1
51,00 - 100,00	12	-	12,37	1

**> Ref. 7106 Cono Morse / Cône morse / Morse taper**



Ø mm	D mm	Hex.	€	
18,00 - 30,00	CM2	-	33,28	1
31,00 - 100,00	CM2	-	33,28	1

**> Ref. 7107 Broca de Centrar / Foret de centrage / Centre drill-bit**



Ø mm	D mm	Hex.	€	
10,00 - 13,00	-	6	2,90	1
14,00 - 50,00	-	6	3,12	1
51,00 - 100,00	-	8	3,33	1

**Bimetal M42**



Ref.	Ø mm	Husillos Arbres Spindles	L mm	€	
7163	22,00-25,00-29,00-32,00-38,00	14-30/32-250	-	183,70	1
7164	22,00-29,00-35,00-44,00-51,00-64,00	14-30/32-250	-	222,02	1
7165	19,00-22,00-29,00-38,00-44,00-57,00	14-30/32-250	-	212,63	1
7166	19,00-22,00-25,00-29,00-35,00 38,00-44,00-51,00-57,00	14-30/32-250	-	271,59	1
7115/1	25,00-35,00-43,00-51,00-64,00	14-30/32-210	-	202,24	1
7116/1	19,00-22,00-25,00-29,00-38,00-48,00	14-30/32-210	-	202,07	1
7117	19,00-22,00-25,00-32,00-35,00-38,00 43,00-51,00-57,00-60,00-64,00-76,00	14-30/32-210	330	397,58	1
7148	22,00-25,00-33,00-35,00-41,00-51,00	14-30/32-210	-	234,02	1

**Bimetal Dentado Fino M42**  
Denture Fine / Fine Tooth Pitch

Estuches / Coffrets / Cases



Ref.	Ø mm	Husillos Arbres Spindles	L mm	€	
7115/2	25,00-35,00-43,00-51,00-60,00	14-30/32-210	-	202,24	1
7116/2	19,00-22,00-25,00-29,00-38,00-48,00	14-30/32-210	-	202,31	1

**Bimetal Cambio Rápido M42**  
Changement Rapide / Quick Change

Estuches / Coffrets / Cases



Ref.	Ø mm	Husillo cambio rápido Arbre changement rapide Quick-change spindle	€	
7147	19,00-22,00-25,00-32,00-35,00-38,00 43,00-51,00-57,00-60,00-64,00-76,00	14-210	394,86	1

**HOJAS DE SIERRA DE MANO  
LAME DE SCIE À MAIN / HAND HACKSAW BLADE**



**APLICACIONES  
APPLICATIONS**

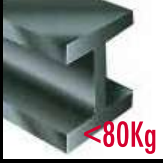

**Acero <80Kg**  
Acier <80Kg / Steel <80Kg

**Características  
Caractéristiques  
Features**



**APLICACIONES  
APPLICATIONS**

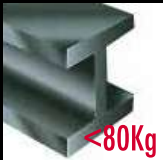

**Acero <80Kg**  
Acier <80Kg / Steel <80Kg

**Características  
Caractéristiques  
Features**



**7501 BIMETAL**



L mm	A mm	e mm	z	€	
300	13	0,65	18	2,66	100
300	13	0,65	24	2,66	100
300	13	0,65	32	2,66	100

**7504 CV**



L mm	A mm	e mm	z	€	
300	13	0,65	24	0,67	100

**HOJAS DE SIERRA DE MANO**  
**LAME DE SCIE À MAIN / HAND HACKSAW BLADE**

**7505 CV**



L mm	A mm	e mm	z	€	
300	25	0,65	24	0,80	50

**APLICACIONES**  
 APPLICATIONS



**Acero <80Kg**  
 Acier <80Kg / Steel <80Kg

**Características**  
 Caractéristiques  
 Features



# SIERRAS DE CALAR SCIES SAUTEUSES / JIG SAWS

	Ref.	FOTO	Ref. Bosch	€	uds. envasado	Calidad sierra	Longitud x paso	Tipo dentado	Tipo corte	
<b>MADERA BOIS WOOD</b>	7604		T111C	7,62	5	HCS	75 x 3			
	7603		T144D	8,17	5	HCS	75 x 4-5,2			
	7624		T244D	9,31	5	HCS	75 x 4-5,2			
	7614		T344D	11,55	5	HCS	125 x 4			
	7601		T101B	10,73	5	HCS	75 x 2,7			
	7602		T101D	10,73	5	HCS	75 x 4-5,2			
	7621		T101BR	11,28	5	HCS	75 x 2,5			
	7622		T301CD	13,54	5	HCS	90 x 3			
	7642		T101DP	11,55	5	HCS	75 x 4			
	7643		T234X	17,49	5	HCS	93 x 2-3			
	7644		T308B	18,04	5	HCS	93 x 2,2			
	7623		T101AIF	20,02	5	BIMETAL	75 x 1,6			
	7645		T141HM	21,41	1	HM	75 x 4,3			
	7646		T345XF	25,95	5	BIMETAL	105 x 2,4-5			
	<b>METAL MÉTAUX METAL</b>	7626		T318A	14,66	5	HSS	105 x 1,2		
		7607		T118A	10,73	5	HSS	67 x 1,1-1,5		
7609			T118B	10,73	5	HSS	67 x 1,9-2,3			
7611			T127D	11,28	5	HSS	75 x 3			
7647			T123X	14,66	5	HSS	75 x 1,2-2,6			
7648			T321AF	20,30	5	BIMETAL	105 x 1,2			
7629			T118AF	14,09	5	BIMETAL	67 x 1,1-1,5			
7649			T118BF	14,09	5	BIMETAL	67 x 1,9-2,3			
7650			T118AHM	16,63	1	HM	60 x 1,1			
<b>GRES GRÈS</b>		7651			7,89	1	HM	75 x 1/2		





# HOJAS DE SABLE SCIES SABRE / FOR SABRE

	Ref.	FOTO	Ref. Bosch	€	uds. envasado	Calidad sierra	Longitud x paso	Tipo dentado	Tipo corte
<b>MADERA BOIS WOOD</b>	7701		S1344D	29,87	5	HCS	280 x 6		
	7702		S644D	18,04	5	HCS	130 x 6		
	7703		S1531L	32,14	5	HCS	220 x 4-5		
	7704		S611DF	25,37	5	BIMETAL	130 x 6		
	7705		S1111DF	57,49	5	BIMETAL	210 x 6		
	7706		S3456XF	46,23	5	BIMETAL	180 x 11-5		
<b>METAL MÉTAUX METAL</b>	7707		S922BF	21,98	5	BIMETAL	130 x 14		
	7708		S1122BF	27,62	5	BIMETAL	180 x 12,7		
	7709		S522EF	17,49	5	BIMETAL	80 x 18		
	7710		S922EF	21,98	5	BIMETAL	130 x 18		
	7711		S1122VP	27,62	5	BIMETAL	180 x 18		
	7712		S922VF	21,98	5	BIMETAL	130 x 10-14		
	7713		S1122VP	27,62	5	BIMETAL	230 x 10-14		
<b>ESPECIAL DEMOLICIÓN DEMOLITION</b>	7714		S926CHF	42,27	5	BIMETAL	130 x 8-10		
	7715		S1126CHF	50,74	5	BIMETAL	210 x 8-10		
	7719		S1226CHF	62,01	5	BIMETAL	210 x 8-10		
	7717		S922EHM	30,44	1	HM	130 x 18		
	7718		S1243HM	81,74	1	HM	280 x 2		

Madera	Madera tornillos	Aglomerados	Madera verde	Metal	Aluminio	Inox	CU, NI, Ns, Zn Cu, Ni, Ms, Zn	Gres/Cerámica	Ladrillo/Hormigón	Sandwich	Fibro cemento	CFK	Plástico
●		●											●
●		●											●
●			●										
	●												●
	●												●
	●						●						●
				●	●		●						
				●	●		●						
				●									
				●									
				●									
	●			●									
	●			●									
	●			●									
				●		●							
				●						●		●	

**OSCILANTES MULTI-FUNCIÓN**  
**OUTILS MULTIFONCTIONS / OSCILLATING MULTI-TOOLS**

APLICACIÓN	REF.	FOTO	ref. Bosch	enganche	€	Uds. envasado	calidad sierra	ancho x alto	dentado
MADERA BOIS WOOD	7720		AIZ 32EPC	STARLOCK	21,25	1	HSC	34x48	1,4
	7721		AIZ 32BSPC	STARLOCK	21,25	1	HSC	32x48	1,8
	7722		AIZ 32BSPB	STARLOCK	28,36	1	Bi-Metal	32x48	1,8
	7723		AII 65BSPC	STARLOCK	26,50	1	HSC	65x40	1,8
	7724		AII65BSPB	STARLOCK	34,13	1	Bi-Metal	65x40	1,8
	7725		PAIZ 32EPC	STARLOCK PLUS	29,52	1	HCS	32x60	1,4
METAL	7726		AIZ 20AB	STARLOCK	20,19	1	Bi-Metal	20x32	1,3
	7727		AIZ 32AB	STARLOCK	23,64	1	Bi-Metal	32x50	1,3
	7728		AIZ 32APB	STARLOCK	29,36	1	Bi-Metal	32x50	1,3
	7729		AII 65APB	STARLOCK	34,13	1	Bi-Metal	65x37	1,3
	7730		ACZ 85EB	STARLOCK	38,32	1	Bi-Metal	ø85	1,4
	7731		PAIZ 32APB	STARLOCK PLUS	38,11	1	Bi-Metal	32x60	1,3
	7732		PAII 65APB	STARLOCK PLUS	45,10	1	Bi-Metal	65x50	1,3
	7733		MAIZ 32APB	STARLOCK MAX	37,84	1	Bi-Metal	32x80	1,3
	7734		MAII 52APB	STARLOCK MAX	41,18	1	Bi-Metal	52x70	1,3
METAL / INOX	7735		AIZ 32AT	STARLOCK	46,69	1	MD	32x37	1,1



**OSCILANTES MULTI-FUNCIÓN**  
**OUTILS MULTIFONCTIONS / OSCILLATING MULTI-TOOLS**

APLICACIÓN	REF.	FOTO	ref. Bosch	enganche	€	Uds. envasado	calidad sierra	ancho x alto	dentado
ABRASIVO/ ESPECIAL  ABRASIF/ SPÉCIAL  ABRASIVE/ SPECIAL	7736		AVZ 70 RT4	STARLOCK	86,60	1	MD K40	ø70	
	7737		ACZ 70 RT5	STARLOCK	50,35	1	MD K50	ø70	
	7738		ACZ 85 RT3	STARLOCK	59,31	1	MD K30	ø85	
	7739		ACZ 85 RD4	STARLOCK	96,04	1	DIA-MAN-TE	ø85	
	7740		AVZ 78 RT2	STARLOCK	47,75	1	K20	ø78	
	7741		AIZ 28SC	STARLOCK	31,75	1		28x50	
	7742		ACZ 100SWB	STARLOCK	69,43	1		ø100	
	7743		ATZ52 SC	STARLOCK	24,65	1		52x26	
	7744		AVZ 93G	STARLOCK	19,40	1		ø93	
	7745		MATI68RT3	STARLOCK MAX	76,27	1	K30	68x30	
	7746		MATI68RST5	STARLOCK MAX	76,27	1	K50	68x30	
	7747		MATI68RD4	STARLOCK MAX	126,88	1	K40	68x30	

Fibra Vidrio	CFK	Gres/Cerámica	Abrasivos	Pulido	Aislamiento	Caucho	Restos blandos	Siliconas
●								
●		●	●					
●		●	●					
●		●	●					
●	●	●	●					
			●	●				
			●					●
			●		●	●	●	
			●	●			●	
●		●	●					
●		●	●					
●	●	●	●					

**6118** Automático  
Automatique / Automatic

- > De uso en taladros portátiles percutores. > Dispositivo de cierre de seguridad.  
Perceuses portables à percussion. Dispositif de fermeture de sécurité.  
For use with portable percussive drills. Safety lock.



Ø mm	d mm	k	l1 mm	l2 mm	pack		blister	
					Ref. 6118	Ref. 8156	Ref. 6118	Ref. 8156
1,00-10,00	42	3/8" x 24H UNF	65	78	€ 67,00	1	€ 67,59	1
2,00-13,00	42	1/2" x 20H UNF	65	78	€ 77,77	1	€ 78,36	1

**6105** Llave Pro  
Clé Pro / Pro Key

- > Cierre manual con llave. > De uso en taladros portátiles.  
Serrage manuel avec clé. Sur perceuses portables.  
Manual lock with key. For use with portable drills.
- > Componentes templados y rectificados.  
Avec des composants trempés et rectifiés.  
Tempered and rectified components.



Ø mm	d mm	k	l1 mm	l2 mm	gr.	Ref.	pack		blister	
							Ref. 6105	Ref. 8119/1	Ref. 6105	Ref. 8119/1
1,00-10,00	36,5	1/2" x 20 H	50	60	220	Ref. 6109	€ 42,03	1	€ 42,61	1
1,50-13,00	42,7	1/2" x 20 H	59	74	370	Ref. 6109	€ 53,93	1	€ 54,54	1

**6106**

**Llave**  
Clé / Key

- > Cierre manual con llave  
Serrage manuel avec clé.  
Key manual lock.
- > De uso en taladros portátiles  
Sur perceuses portables.  
For use with portable drills.

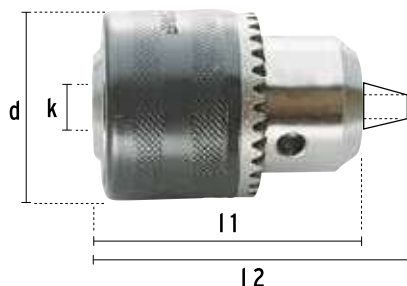

Ø mm	d mm	k	l1 mm	l2 mm	gr.	Ref.	pack		blister	
							Ref. 6106	Ref. 8119	€	€
1,00-10,00	33	1/2" x 20 H	49	59	160	Ref. 6109	23,02	1	23,62	1
1,50-13,00	42,7	1/2" x 20 H	59	74	355	Ref. 6109	25,74	1	26,32	1

**6117**

**SDS+**



d1 mm	d2 mm	d3 mm	k	L mm	caja		blister	
					Ref. 6117	Ref. 8175	€	€
21,5	28	29,5	1/2" x UNF	59	88,68	1	89,31	1

(Hasta fin de existencias / Jusqu'à épuisement des stocks / While supplies last)

**1224**

**Adaptador SDS+**  
Adaptateur SDS+ / SDS MAX adaptor



> SDS MAX

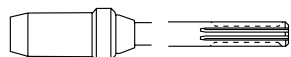

L mm	Ref. 1224	
	€	pack
220	115,49	1



**6107** > **Adaptador Black & Decker**  
Adaptateur Black & Decker / Black & Decker adaptor



Rosca Filetage Thread	L mm	gr	caja		blister	
			Ref. 6107	Ref. 8120	Ref. 6107	Ref. 8120
3/8 - 1/2	-	30	€ 5,12	1	€ 5,70	1

**6108** > **Adaptador SDS+**  
Adaptateur SDS+ / SDS+ adaptor



Rosca Filetage Thread	L mm	gr	caja		blister	
			Ref. 6108	Ref. 8121	Ref. 6108	Ref. 8121
1/2 - 20	63	55	€ 31,56	1	€ 32,15	1

**6109** > **Llave de recambio**  
Clé de Rechange / Spare key



Ref.	caja		blister	
	Ref. 6109	Ref. 8122	Ref. 6109	Ref. 8122
6109	€ 4,85	1	€ 5,43	1

## **Herpuc** EXPOSITORES

**Claridad expositiva en el punto de venta para que la elección del producto sea más fácil y cómoda.**

PRÉSENTOIRS: Clarté de l'exposition sur le point de vente pour plus de facilité et de commodité dans le choix du produit.

DISPLAY STANDS: Clarity of display at the point of sale so that the selection of the product may be easier and more comfortable.

## **Herpuc** PACKAGING



**Nuestra amplia gama de alternativas en la presentación del producto le ayudará a la hora de segmentar a su público, además de especializar la venta a profesionales.**

Notre large gamme d'alternatives pour la présentation du produit vous aidera à segmenter votre public ainsi qu'à spécialiser la vente aux professionnels.

Our wide range of alternatives for presenting the product will help when segmenting your clients, in addition to specializing sales to professionals.



**TUBO / TUBE**



**PACK**



**CLIP**



**CAJA / BOÎTE / BOX**

# **Herpuc CENTER**

- Libre composición
- Productos de alta rotación
- Implantación personalizada
  
- Libre composition
- Produit de haute rotation
- Implantation personnalisée
  
- Free composition
- Hight rotation products
- Customized implementation



**8207/1** Rectificada (HSS DIN 338 N)

Ø mm	Icon	Ø mm	Icon	Ø mm	Icon
1,00	40	4,50	40	10,00	20
1,50	20	5,00	60	11,00	10
2,00	40	5,50	40	12,00	10
2,25	40	6,00	60	13,00	5
2,50	40	6,50	20	TOTAL	795
3,00	60	7,00	20	€	1.469,27
3,25	40	7,50	20		
3,50	40	8,00	30		
4,00	60	8,50	20		
4,25	40	9,00	20		



**8207/2** Speedplus (HSS DIN 338 NSP)

Ø mm	Icon	Ø mm	Icon	Ø mm	Icon
1,00	40	4,25	40	8,50	20
1,50	20	4,50	40	9,00	20
2,00	40	5,00	60	10,00	20
2,25	40	5,50	40	11,00	10
2,50	40	6,00	60	12,00	10
3,00	60	6,50	20	13,00	5
3,25	40	7,00	20	TOTAL	795
3,50	40	7,50	20	€	1.619,36
4,00	60	8,00	30		



**8207/3** Cobalt (HSSCO DIN 338 N)

Ø mm	Icon	Ø mm	Icon	Ø mm	Icon
1,00	40	4,50	40	10,00	20
1,50	20	5,00	60	11,00	10
2,00	40	5,50	40	12,00	10
2,25	40	6,00	60	13,00	5
2,50	40	6,50	20	TOTAL	795
3,00	60	7,00	20	€	2.704,59
3,25	40	7,50	20		
3,50	40	8,00	30		
4,00	60	8,50	20		
4,25	40	9,00	20		



**8207/4** Cobalt W (HSSCO DIN 338 W)

Ø mm	Icon	Ø mm	Icon	Ø mm	Icon
1,00	40	4,25	40	8,50	20
1,50	20	4,50	40	9,00	20
2,00	40	5,00	60	10,00	20
2,25	40	5,50	40	11,00	10
2,50	40	6,00	60	12,00	10
3,00	60	6,50	20	13,00	5
3,25	40	7,00	20	TOTAL	795
3,50	40	7,50	20	€	4.153,98
4,00	60	8,00	30		



**8207/5** Titanium (HSSTIN DIN 338 N)

Ø mm	Icon	Ø mm	Icon	Ø mm	Icon
1,00	40	4,25	40	8,50	20
1,50	20	4,50	40	9,00	20
2,00	40	5,00	60	10,00	20
2,25	40	5,50	40	11,00	10
2,50	40	6,00	60	12,00	10
3,00	60	6,50	20	13,00	5
3,25	40	7,00	20	TOTAL	795
3,50	40	7,50	20	€	3.334,23
4,00	60	8,00	30		



> Ref. 8211

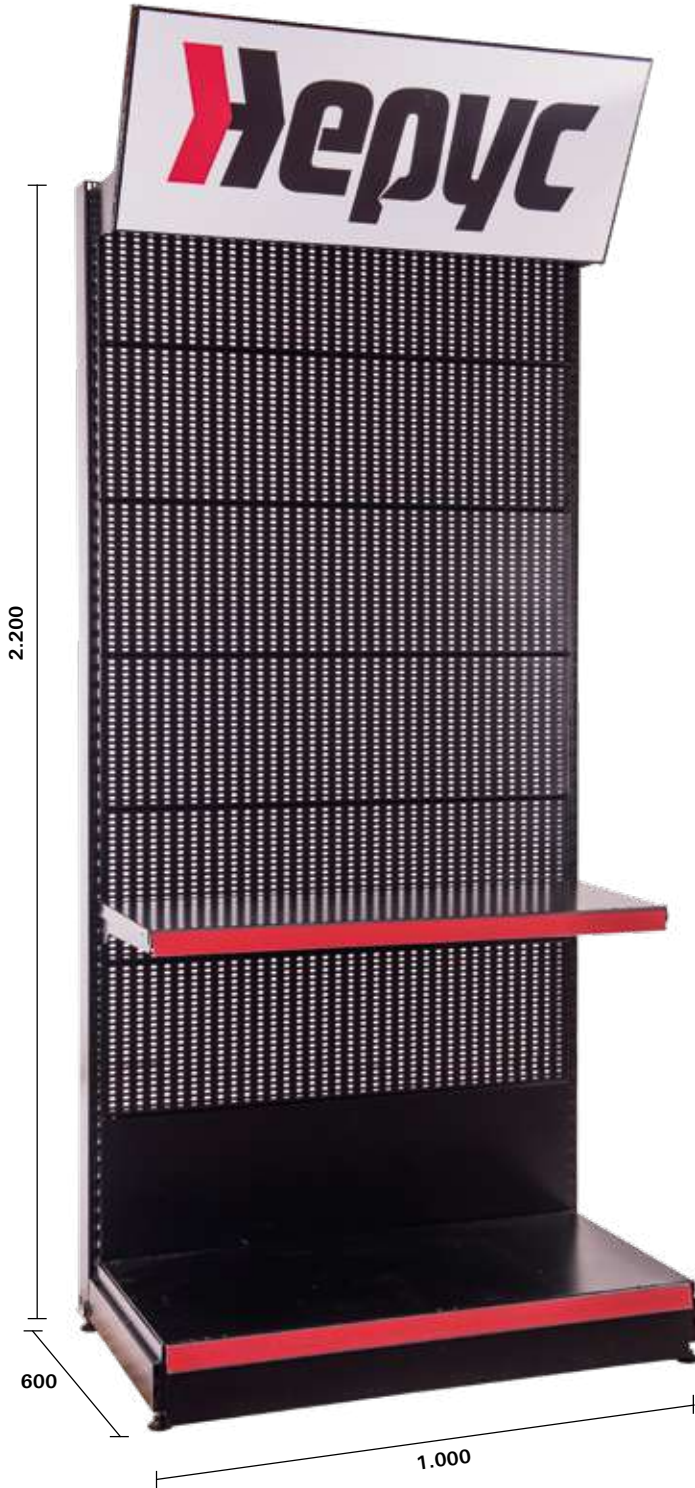

€ 988,77

> Ref. 8212

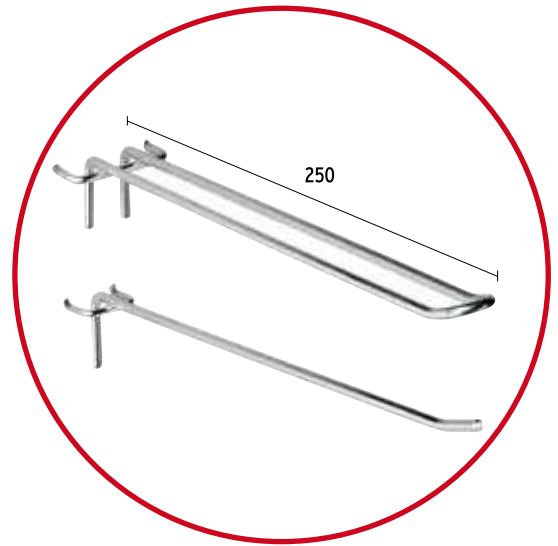

Ref.	€
8212/1	9,06
8212/2	6,77

> Ref. 8207

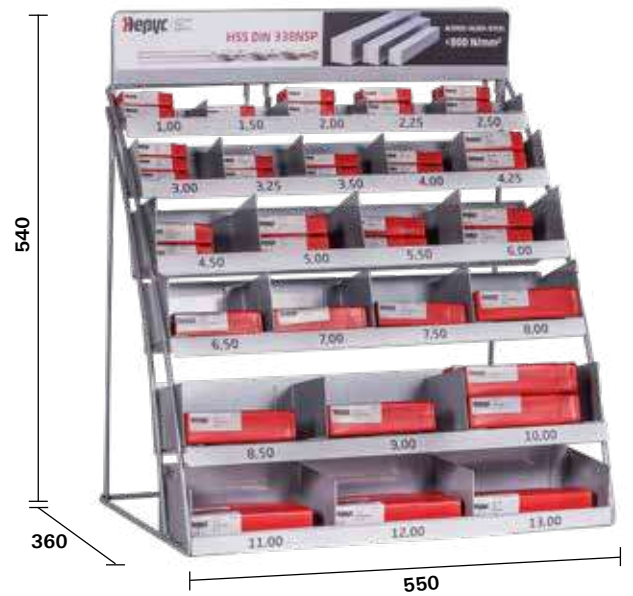

€ 294,60

## FICHA NUEVOS CLIENTES

### FICHE NOUVEAUX CLIENTS / NEW CLIENT DATA SHEET

#### FICHA DE CLIENTE

Representante:..... Código de cliente (rellenar por Hepyc):.....

CIF:..... Persona de contacto (nombre y apellido):.....

Dirección de facturación:..... C.P.:.....

Dirección de envío de mercancías (si es diferente):.....

Tel.:..... Fax:..... E-mail:.....

Forma de pago:..... Días pago:.....

CC:..... Dto a aplicar:.....

#### FORMULAIRE NOUVEAUX CLIENTS

Agent comercial:..... Nom de la société:.....

Raison sociale:..... SIREN/SIRET:.....

Nº Intracommunautaire (TVA):.....

Personne à contacter:.....

Adresse de facturation:.....

Tél.:..... Fax:..... E-mail:.....

Mode de règlement:.....

IBAN:..... Remise:.....

#### CLIENT DATA SHEET

Representative:..... Client code (to be filled out by Hepyc):.....

Tax Identification Number:.....

Contact person (name and surname):.....

Invoice address:.....

Merchandise delivery address (if different)..... P.C.:.....

Tel.:..... Fax:..... E-mail:.....

Payment method:..... Payment days:.....

IBAN code:..... Discount to be applied:.....

## CONDICIONES DE VENTA (España y Portugal)

### 1º Condiciones de pago:

Giro a 60 días f.f.: NETO.

### 2º Vencimientos:

En caso de fechas fijas de pago que rebasen los plazos estipulados giraremos a la fecha fijada pero inmediata anterior, según corresponda, siendo el plazo máximo en cualquier caso, de 60 días, fecha factura o envío.

### 3º Seguros:

Las mercancías viajarán por exclusiva cuenta y riesgo del comprador, siendo siempre a cargo del mismo la prima del seguro que se realice, en los casos que el cliente desee asegurarla.

### 4º Reclamaciones:

Se atenderán aquellas reclamaciones que se planteen dentro de los 8 días siguientes a la recepción del material, no aceptando ninguna devolución sin previo conocimiento de Manufacturas Hepyc, S.A.

### 5º Condicionalidad:

La aceptación de las mercancías, sin el rechazo inmediato por parte del comprador, supone la aprobación de estas condiciones generales de venta y su modificación sólo tendrá validez si consta por escrito la conformidad de Manufacturas Hepyc, S.A.

### 6º IVA:

Los precios están sujetos al impuesto sobre el valor añadido, siendo a cargo del cliente el recargo correspondiente.

### 7º Garantías:

Todas las herramientas están garantizadas contra cualquier defecto de fabricación y materiales, sin responsabilizarse Manufacturas Hepyc, S.A. de la utilización inadecuada de las mismas. En cualquier caso, nuestra responsabilidad estará limitada al valor de la herramienta suministrada. Nos reservamos el derecho de modificar, sin previo aviso, las dimensiones, calidades de acero y en general todas las características técnicas de las herramientas. No será sustituida ninguna herramienta sin un informe previo de Control de Calidad.

### 8º Portes:

Se suministrarán a portes pagados aquellos envíos a Península y Baleares cuyo valor neto en factura supere los 150 euros.

En aquellos casos de facturación mensual, quincenal, etc., Manufacturas Hepyc, S.A. cargará en factura los portes correspondientes a los envíos inferiores a 150 euros aunque la factura global (mensual, quincenal) supere dicha cantidad.

### 9º Importe mínimo por pedido:

Queda establecido como pedido mínimo la cantidad de 60 euros netos. Los clientes no habituales que cursen pedidos inferiores a 60 euros pagarán al contado o contra reembolso.

### 10º Envío de facturas:

Salvo indicación expresa por parte del cliente, se despacharán directamente.

### 11º Reserva de dominio:

Nuestras ventas se consideran siempre bajo la condición de "RESERVA DE DOMINIO", según el artículo 1506 del C.C. hasta que se haya hecho efectivo íntegramente el pago de todo lo adeudado.

### 12º Jurisdicción competente:

En caso de cualquier litigio por razón de incumplimiento por cualquiera de las partes, se someterán ambas al fuero de los JUZGADOS Y TRIBUNALES DE SAN SEBASTIÁN, con denuncia al que pudiera corresponderles.



## CONDITIONS DE VENTE (France)

### 1° Tarif de prix:

Les prix figurants dans ce tarif sont des prix conseillés et s'entendent HORS TAXES, emballage compris.

### 2° Remise sur Tarif:

Remise à confirmer par notre agent.

### 3° Délai d'expédition:

Service normal: Commandes reçues avant 14 heures partiront de Hepyc le jour même et seront chez le client en 24-48 heures.

Service express: Sous 24 heures.

### 4° Port:

FRANCO pour les expédition dont la valeur nette facturée dépasse les 250 euros.

Les commandes inférieures à 250 euros seront majorés d'un forfait de 15 euros.

Manufacturas Hepyc, SA se réserve le droit d'utiliser le moyen de transport le plus économique.

Manufacturas Hepyc, SA facturera les ports concernant les envois d'outils peu courants qui, à la demande du client, devront être livrés en urgence à travers des agences de transport rapide.

### 5° Condition de paiement:

Le délai de paiement part de la date de facturation. Par LCR magnétique à 60 jours calendaires ou 45 jours fin de mois.

### 6° Assurances:

Le marchandises seront transportées aux risques et périls exclusifs de l'acheteur, celui-ci étant responsable de la prime d'assurance le cas échéant.

### 7° Réclamations:

Les réclamations seront acceptées dans un délai de 8 jours à partir de la réception du matériel; aucun retour ne sera accepté sans l'accord préalable de Manufacturas Hepyc, SA.

### 8° Conditionnalité:

L'acceptation de marchandises sans le rejet immédiat de la part de l'acheteur suppose l'approbation de ces conditions générales de vente et leur modification n'aura de validité que sur confirmation écrite de Manufacturas Hepyc, SA.

### 9° Garanties:

Tous les outils sont garantis contre n'importe quel défaut de fabrication et de matériaux, Manufacturas Hepyc, SA. n'étant pas responsable de leur utilisation inadéquate. Dans tous les cas, notre responsabilité sera limitée à la valeur de l'outil fourni. Nous nous réservons le droit de modifier, sans avertissement préalable, les dimensions, les qualités d'acier et en général toutes les caractéristiques techniques des outils. Aucun outil ne sera remplacé sans rapport préalable du contrôle de qualité.

### 10° Réserve de propriété:

La marchandise reste la pleine et entière propriété de la Société Manufacturas Hepyc, SA tant que le règlement intégral n'aura pas été effectué et ce en application de la loi du 12 mai 1980.

## SALES CONDITIONS (Export)

### 1. Price List:

The prices that appear on this price list are recommended and DO NOT INCLUDE TAXES or packaging.

**2. Discount:** Discount to be confirmed by Manufacturas Hepyc.

### 3. Payment conditions:

Terms of payment set from invoice date.

First order must be paid in advanced. Rest of the orders to be agreed.

### 4. Insurance:

The merchandise will be transported exclusively at the purchaser's risk, the purchaser is responsible for the insurance premium if it is necessary.

### 5. Claims:

Claims will be accepted within the 8 days following the receipt of the merchandise; no returns will be accepted without the prior agreement of Manufacturas Hepyc, SA.

### 6. Conditions :

The acceptance of merchandise without the immediate rejection on the part of the purchaser supposes the acceptance of these general sales conditions and their modification will not be valid without the written consent of Manufacturas Hepyc, SA.

### 7. Guarantees:

All tools are guaranteed against any material or manufacturing defect, Manufacturas Hepyc, SA. is not responsible for their improper use. In all cases, our responsibility will be limited to the tool provided. We reserve the right to modify, without preliminary warning, the dimensions, steel qualities and all design features of the tools in general. No tool will be replaced without the preliminary quality control report.

### 8. Reservation of title:

The merchandise remains the sole and exclusive property of the Manufacturas Hepyc, SA Corporation as long as the full payment is outstanding pursuant to the law of 12 May 1980.

# Can we **Help** you?

## **ATENCION AL CLIENTE NACIONAL**

Tel. +34 943 33 50 40  
Fax +34 943 33 52 24  
ventas@hepyc.com

## **EXPORT CUSTOMER SERVICE**

Tel. +34 943 33 60 03  
Fax +34 943 33 52 24  
export@hepyc.com

## **S.A.T**

Tel: +34 943 33 52 26  
Fax: +34 943 33 52 24  
sat@hepyc.com

## **SEDE SOCIAL / HEAD OFFICE**

Pol. Ind. Ibarluce 57 - E Izq.  
20120 Hernani (Spain)  
Tel. +34 943 33 52 25  
Fax +34 943 33 52 24  
ventas@hepyc.com

## **HEPYC CATALUÑA**

C/Xarol, 12 - B  
08915 Badalona (Spain)  
Tel. +34 933 87 32 99  
Fax +34 933 83 33 08  
vendes@hepyc.com

## **HEPYC MADRID**

C/ Conde Vistahermosa, 46  
28019 Madrid (Spain)  
Tel. +34 915 69 81 05  
Fax +34 915 65 97 91  
madrid@hepyc.com